

Triple 128-Position Nonvolatile Digital Variable Resistor/Switch

DS3904/DS3905

General Description

The DS3904/DS3905 contain three nonvolatile (NV) low temperature coefficient, variable digital resistors. Each resistor has 128 user-selectable positions. Additionally, the DS3904/DS3905 have a high-impedance setting that allows each resistor to function as a digital switch. The DS3904/DS3905 can operate over a 2.7V to 5.5V supply voltage range, and communication with the device is achieved through a 2-wire serial interface. Address pins allow multiple DS3904/DS3905s to operate on the same two-wire bus. The DS3904 has one address pin, allowing two DS3904s to share the bus, while the DS3905 has three address pins, allowing up to eight DS3905s to share a common bus. The low-cost and small size of the DS3904/DS3905 make them ideal replacements for conventional mechanical trimming resistors.

Features

- ◆ Three 20kΩ, or Two 20kΩ and One 10kΩ, 128-Position Linear Digital Resistors
- ◆ Resistor Settings are Stored in NV Memory
- ◆ Each Resistor has a High-Impedance Setting for Switch Operation to Control Digital Logic
- ◆ Low Temperature Coefficient
- ◆ 2-Wire Serial Interface
- ◆ 2.7V to 5.5V Operating Range
- ◆ -40°C to +85°C Industrial Temperature
- ◆ Packaging: 8-Pin μSOP for DS3904, 10-pin μSOP for DS3905

Ordering Information

PART	TEMP RANGE	PIN-PACKAGE	(R0/R1/R2) RESISTANCE (kΩ)
DS3904U-010	-40°C to +85°C	8 μSOP	20/10/20 + High-Z
DS3904U-020	-40°C to +85°C	8 μSOP	20/20/20 + High-Z
DS3905U-020	-40°C to +85°C	10 μSOP	20/20/20 + High-Z

Applications

- Power-Supply Calibration
- Cell Phones and PDAs
- Fibre Optic Transceiver Modules
- Portable Electronics
- Small and Low-Cost Replacement for Conventional Mechanical Trimming Resistors/ Dip Switches
- Test Equipment

Pin Configurations

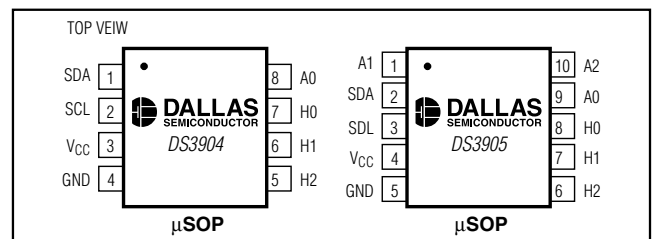

Typical Operating Circuit

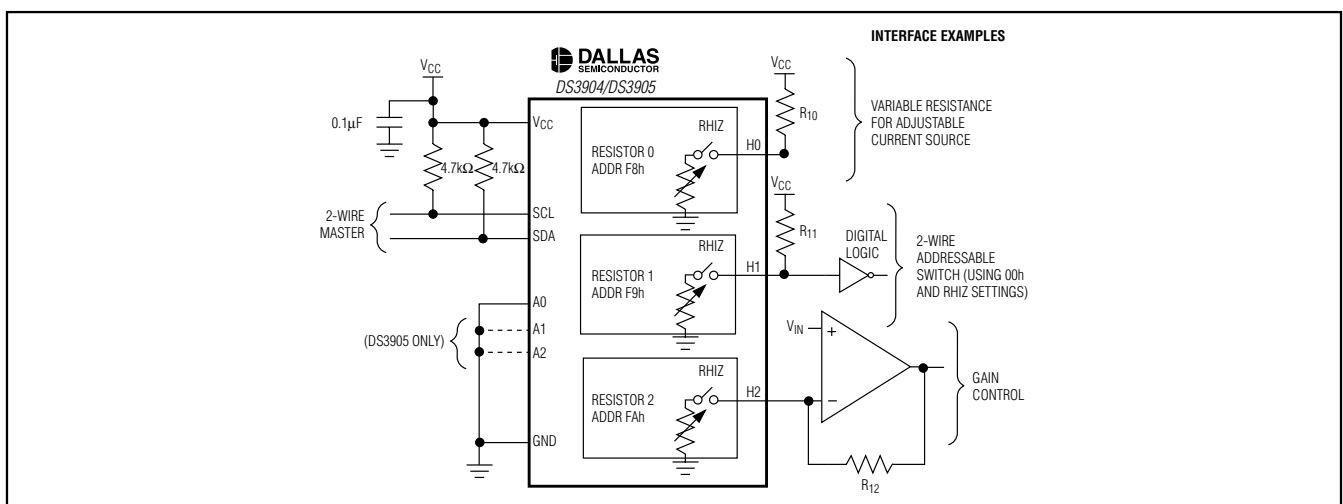

Triple 128-Position Nonvolatile Variable Digital Resistor/Switch

ABSOLUTE MAXIMUM RATINGS

Voltage on V_{CC} Pin Relative to Ground-0.5V to +6.0V
 Voltage on SDA, SCL, A0, A1, A2
 Relative to Ground*-0.5V to V_{CC} + 0.5V
 Voltage on H0, H1, and
 H2 Relative to Ground-0.5V to +6.0V
 Current Through H0, H1, and H23mA

Operating Temperature Range-40°C to +85°C
 Programming Temperature Range0°C to +70°C
 Storage Temperature Range-55°C to +125°C
 Soldering TemperatureSee J-STD-020 Specification

*This voltage must not exceed 6.0V.

Stresses beyond those listed under "Absolute Maximum Ratings" may cause permanent damage to the device. These are stress ratings only, and functional operation of the device at these or any other conditions beyond those indicated in the operational sections of the specifications is not implied. Exposure to absolute maximum rating conditions for extended periods may affect device reliability.

RECOMMENDED DC OPERATING CONDITIONS

(T_A = -40°C to +85°C)

PARAMETER	SYMBOL	CONDITIONS	MIN	TYP	MAX	UNITS
Supply Voltage	V _{CC}	(Note 1)	2.7		5.5	V
Input Logic 1	V _{IH}		0.7 x V _{CC}		V _{CC} + 0.3	V
Input Logic 0	V _{IL}		-0.3		0.3 x V _{CC}	V
Resistor Current	I _R				3	mA
Resistor Terminals H0, H1, H2		V _{CC} = +2.7V to +5.5V	-0.3		+5.5	V

DC ELECTRICAL CHARACTERISTICS

(V_{CC} = +2.7V to +5.5V, T_A = -40°C to +85°C, unless otherwise noted.)

PARAMETER	SYMBOL	CONDITIONS	MIN	TYP	MAX	UNITS
Input Leakage	I _L	(Note 2)	-1		+1	μA
Standby Supply Current	I _{STBY}	V _{CC} = 3V (Note 3)		95	200	μA
		V _{CC} = 5V (Note 3)		145	200	
Low-Level Output Voltage (SDA)	V _{OL1}	3mA sink current	0		0.4	V
	V _{OL2}	6mA sink current	0		0.6	

ANALOG RESISTOR CHARACTERISTICS

(V_{CC} = +2.7V to +5.5V, T_A = -40°C to +85°C, unless otherwise noted.)

PARAMETER	SYMBOL	CONDITIONS	MIN	TYP	MAX	UNITS
Absolute Linearity (Note 4)	INL	20kΩ resistor	-1		+1	LSB
		10kΩ resistor	-1		+1	
Relative Linearity (Note 5)	DNL	20kΩ resistor	-0.5		+0.5	LSB
		10kΩ resistor	-0.5		+0.5	
Temperature Coefficient (Note 6)		Position 7Fh (20kΩ resistor)	-200	+123	+400	ppm/°C
		Position 7Fh (10kΩ resistor)	-150	+173	+450	

Triple 128-Position Nonvolatile Digital Variable Resistor/Switch

DS3904/DS3905

ANALOG RESISTOR CHARACTERISTICS (continued)

(V_{CC} = +2.7V to +5.5V, T_A = -40°C to +85°C, unless otherwise noted.)

PARAMETER	SYMBOL	CONDITIONS	MIN	TYP	MAX	UNITS
Position 7Fh Resistance	R _{MAX}	T _A = +25°C (20kΩ resistor)	14.5	20	25.5	kΩ
		T _A = +25°C (10kΩ resistor)	8	10	12	
Position 00h Resistance	R _{MIN}	T _A = +25°C	200		500	Ω
High Impedance	R _{HIZ}		5.5			MΩ

AC ELECTRICAL CHARACTERISTICS

(V_{CC} = +2.7V to +5.5V, T_A = -40°C to +85°C.)

PARAMETER	SYMBOL	CONDITIONS	MIN	TYP	MAX	UNITS
SCL Clock Frequency (Note 7)	f _{SCL}	Fast mode	0		400	kHz
		Standard mode	0		100	
Bus Free Time between STOP and START Conditions (Note 7)	t _{BUF}	Fast mode	1.3			μs
		Standard mode	4.7			
Hold Time (Repeated) START Condition (Notes 7, 8)	t _{HD:STA}	Fast mode	0.6			μs
		Standard mode	4.0			
Low Period of SCL Clock (Note 7)	t _{LOW}	Fast mode	1.3			μs
		Standard mode	4.7			
High Period of SCL Clock (Note 7)	t _{HIGH}	Fast mode	0.6			μs
		Standard mode	4.0			
Data Hold Time (Notes 7, 9)	t _{HD:DAT}	Fast mode	0		0.9	μs
		Standard mode	0		0.9	
Data Setup Time (Note 7)	t _{SU:DAT}	Fast mode	100			ns
		Standard mode	250			
Start Setup Time	t _{SU:STA}	Fast mode	0.6			μs
		Standard mode	4.7			
Rise Time of Both SDA and SCL Signals (Note 10)	t _R	Fast mode	20 + 0.1C _B		300	ns
		Standard mode	20 + 0.1C _B		1000	
Fall Time of Both SDA and SCL Signals (Note 10)	t _F	Fast mode	20 + 0.1C _B		300	ns
		Standard mode	20 + 0.1C _B		300	
Setup Time for STOP Condition	t _{SU:STO}	Fast mode	0.6			μs
		Standard mode	4.0			
Capacitive Load for Each Bus Line	C _B	(Note 10)			400	pF
EEPROM Write Time	t _W	(Note 11)		10	20	ms
Startup Time	t _{ST}				2	ms

Triple 128-Position Nonvolatile Digital Variable Resistor/Switch

NONVOLATILE MEMORY CHARACTERISTICS

($V_{CC} = +2.7V$ to $+5.5V$, $T_A = +70^{\circ}C$.)

PARAMETER	SYMBOL	CONDITIONS	MIN	TYP	MAX	UNITS
EEPROM Writes			50,000			

Note 1: All voltages are referenced to ground.

Note 2: Applies to A0, SDA, SCL for the DS3904 and A0, A1, A2, SDA, SCL for the DS3905. Also applies to H0, H1, H2 for both DS3904 and DS3905 when in the high-impedance state.

Note 3: I_{STBY} specified with SDA = SCL = V_{CC} and A0 = GND.

Note 4: Absolute linearity is used to determine expected resistance. Absolute linearity is defined as the deviation from the straight line drawn from the value of the resistance at position 00h to the value of the resistance at position 7Fh.

Note 5: Relative linearity is used to determine the change of resistance between two adjacent resistor positions.

Note 6: Temperature coefficient specifies the change in resistance as a function of temperature. The temperature coefficient varies with resistor position. Limits are guaranteed by design.

Note 7: A fast-mode device can be used in a standard-mode system, but the requirement $t_{SU:DAT} > 250ns$ must then be met. This is automatically the case if the device does not stretch the LOW period of the SCL signal. If such a device does stretch the LOW period of the SCL signal, it must output the next data bit to the SDA line $t_{RMAX} + t_{SU:DAT} = 1000ns + 250ns = 1250ns$ before the SCL line is released.

Note 8: After this period, the first clock pulse is generated.

Note 9: The maximum $t_{HD:DAT}$ has only to be met if the device does not stretch the LOW period (t_{LOW}) of the SCL signal.

Note 10: C_B—total capacitance of one bus line in picofarads, timing referenced to $0.9 \times V_{CC}$ and $0.1 \times V_{CC}$.

Note 11: EEPROM write begins after a stop condition occurs.

Triple 128-Position Nonvolatile Digital Variable Resistor/Switch

Typical Operating Characteristics

($V_{CC} = +5.0V$, $T_A = +25^\circ C$, unless otherwise noted.)

DS3904/DS3905

SUPPLY CURRENT vs. TEMPERATURE

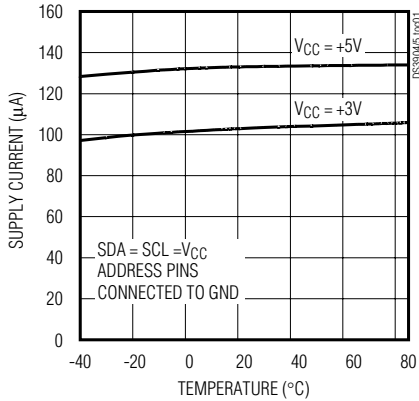

SUPPLY CURRENT vs. SCL FREQUENCY

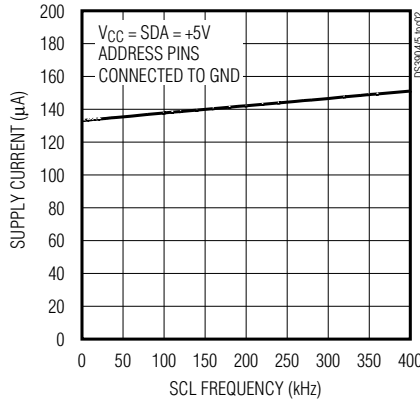

RESISTANCE vs. RESISTOR SETTING

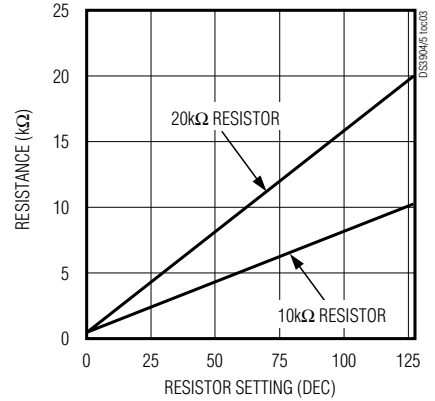

TEMPERATURE COEFFICIENT vs. RESISTOR SETTING

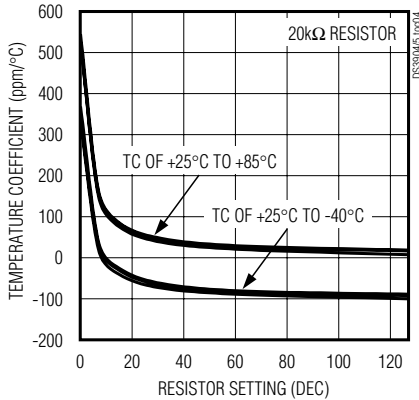

TEMPERATURE COEFFICIENT vs. RESISTOR SETTING

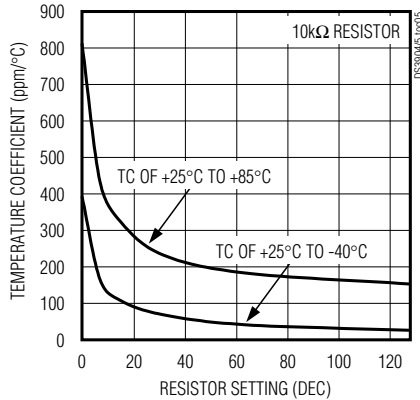

POSITION 7fh RESISTANCE PERCENT CHANGE FROM +25°C vs. TEMPERATURE

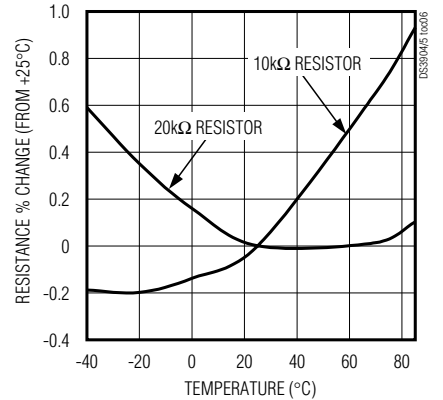

POSITION 00h RESISTANCE PERCENT CHANGE FROM +25°C vs. TEMPERATURE

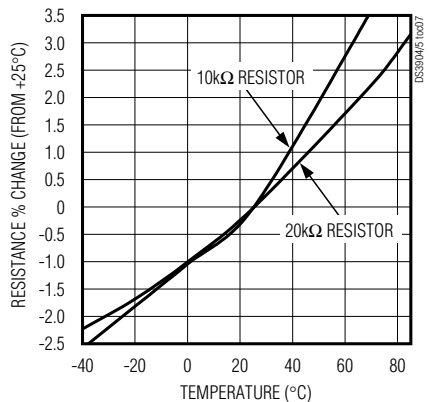

RESISTANCE vs. POWER-UP VOLTAGE

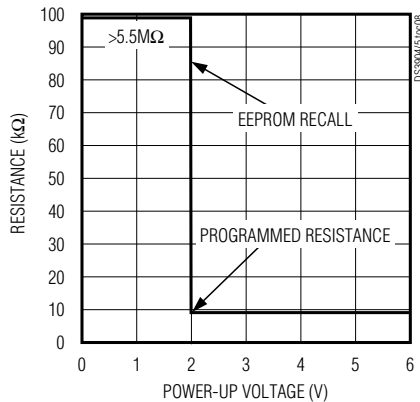

RESISTANCE vs. POWER-DOWN VOLTAGE

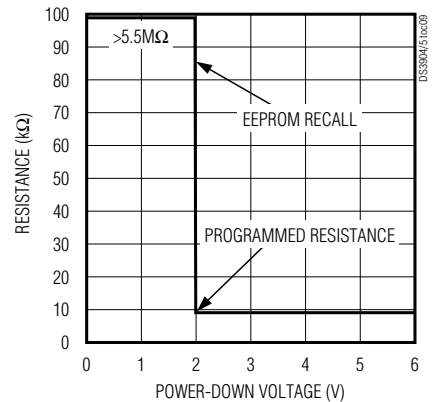

Triple 128-Position Nonvolatile Digital Variable Resistor/Switch

Typical Operating Characteristics (continued)

($V_{CC} = +5.0V$, $T_A = +25^\circ C$, unless otherwise noted.)

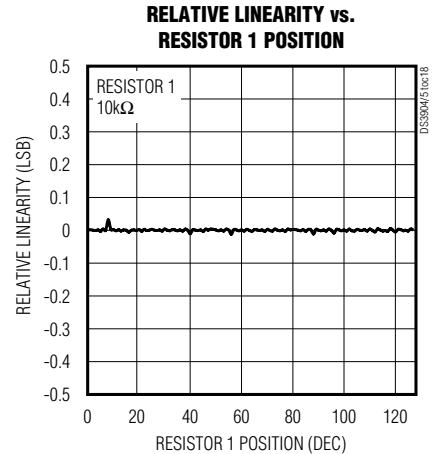
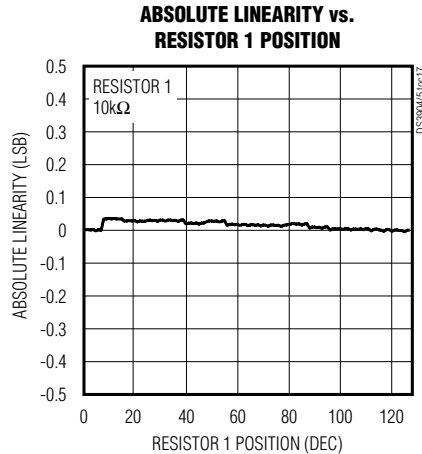
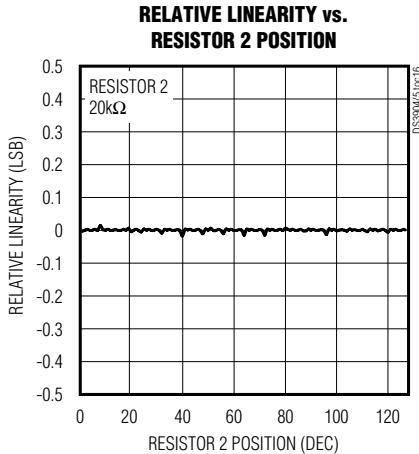
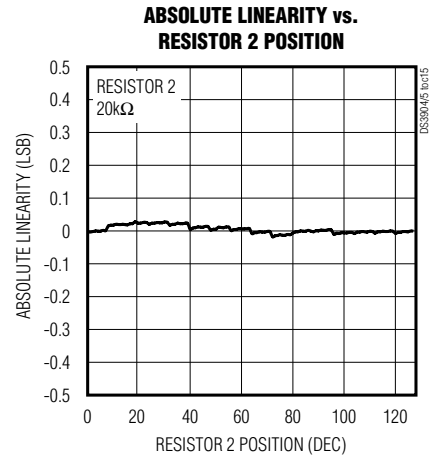
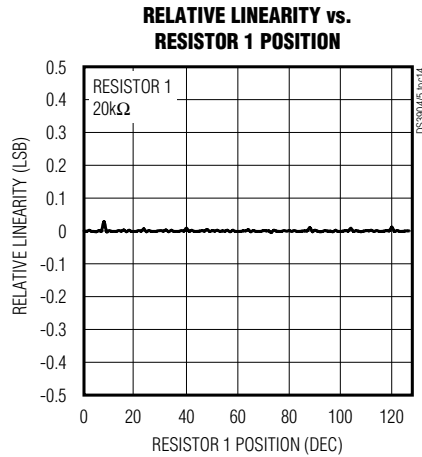
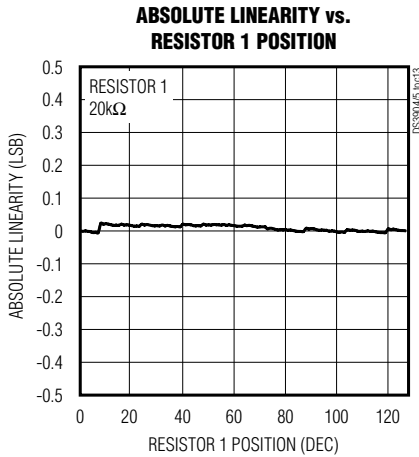
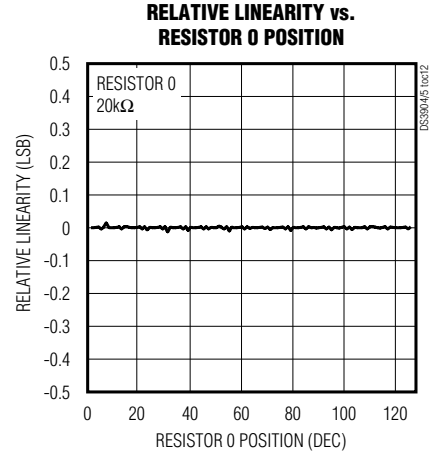
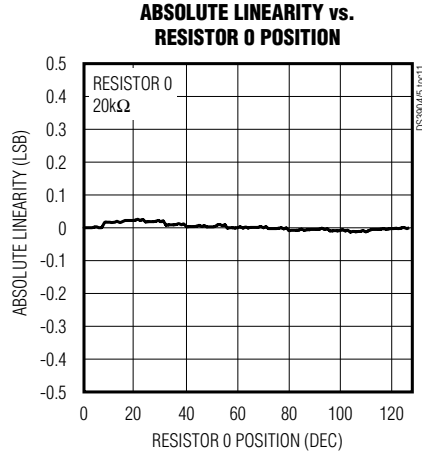
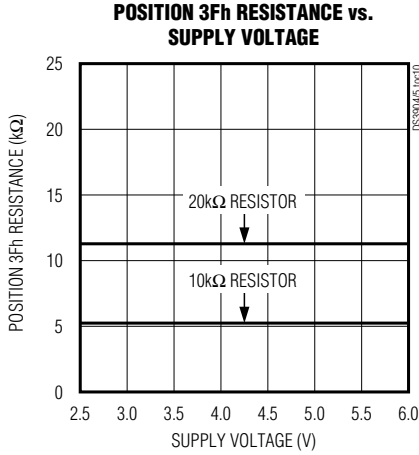

Triple 128-Position Nonvolatile Digital Variable Resistor/Switch

DS3904/DS3905

Pin Description

NAME	PIN		DESCRIPTION
	DS3904	DS3905	
SDA	1	2	2-Wire Serial Data. Open-drain input/output for 2-wire data.
SCL	2	3	2-Wire Serial Clock. Input for 2-wire clock.
V _{CC}	3	4	Supply Voltage Terminal
GND	4	5	Ground Terminal
H2	5	6	Resistor 2 High Terminals
H1	6	7	Resistor 1 High Terminals
H0	7	8	Resistor 0 High Terminals
A0	8	9	Address-Select Pin
A1	—	1	Address-Select Pin (DS3905 Only)
A2	—	10	Address-Select Pin (DS3905 Only)

Detailed Description

The DS3904/DS3905 contain three, 128-position, NV, low temperature coefficient, variable digital resistors. All three resistors also feature a Hi-Z function. The variable resistor registers (F8h, F9h, and FAh) are factory programmed with a default value of 7Fh. They are controlled through a 2-wire serial interface, and can serve as a low-cost replacement for designs using conventional trimming resistors. Furthermore, the DS3904 address pin (A0) allows two DS3904s to be placed on the same 2-wire bus. The three address pins on the DS3905 allow up to eight DS3905s to be placed on the same 2-wire bus.

With their low cost and small size, the DS3904/DS3905 are well tailored to replace larger mechanical trimming variable resistors. This allows the automation of calibration in many instances because the 2-wire interface can easily be adjusted by test/production equipment.

Variable Resistor Memory Organization

The variable resistors of the DS3904/DS3905 are addressed by communicating with the registers in Table 1.

Using the Resistor as a Switch

By taking advantage of the high-impedance mode, a switch can be created to produce a digital output. Setting a resistor register to 00h creates the low state. Writing 80h into the same resistor register enables the high-impedance state. When used with an external pullup resistor, such as a 4.7kΩ pullup, a high state is generated.

Table 1. Variable Resistor Registers

ADDRESS	VARIABLE RESISTOR	POSITION 7Fh RESISTANCE	NUMBER OF POSITIONS*
F8h	Resistor 0	20kΩ (nominal)	128 (00h to 7Fh) + Hi-Z
F9h	Resistor 1	20kΩ or 10kΩ (nominal)	128 (00h to 7Fh) + Hi-Z
FAh	Resistor 2	20kΩ (nominal)	128 (00h to 7Fh) + Hi-Z

*Writing a value greater than 7Fh to any of the resistor registers sets the high-impedance mode control bit (RHIZ, the MSB of the resistor register) resulting in the resistor going into high-impedance mode. Position 0 is the minimum position. Position 7Fh is the maximum position.

Device Operation

Clock and Data Transitions

The SDA pin is normally pulled high with an external resistor or device. Data on the SDA pin can only change during SCL low time periods. Data changes during SCL high periods indicate a start or stop condition depending on the conditions discussed below. See the timing diagrams for further details (Figures 2 and 3).

Start Condition

A high-to-low transition of SDA with SCL high is a start condition, which must precede any other command. See the timing diagrams for further details (Figures 2 and 3).

Stop Condition

A low-to-high transition of SDA with SCL high is a stop condition. After a read or write sequence, the stop command places the DS3904/DS3905 into a low-power mode. See the timing diagrams for further details (Figures 2 and 3).

Acknowledge

All address and data bytes are transmitted through a serial protocol. The DS3904/DS3905 pull the SDA line low during the ninth clock pulse to acknowledge that they have received each byte.

Standby Mode

The DS3904/DS3905 feature a low-power mode that is automatically enabled after power-on, after a stop command, and after the completion of all internal operations.

Triple 128-Position Nonvolatile Digital Variable Resistor/Switch

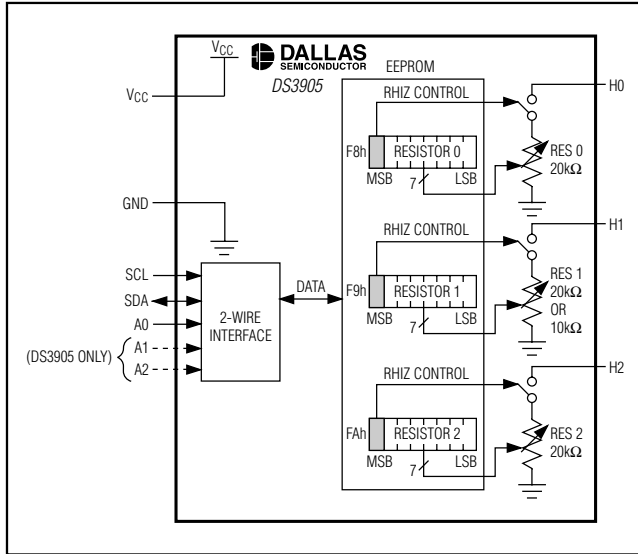

Figure 1. DS3904/DS3905 Block Diagram

Bus Reset

After any interruption in protocol, power loss, or system reset, the following steps reset the DS3904/DS3905:

- 1) Clock up to nine cycles.
- 2) Look for SDA high in each cycle while SCL is high.
- 3) Create a start condition while SDA is high.

Device Addressing

The DS3904/DS3905 must receive an 8-bit device address byte following a start condition to enable a specific device for a read or write operation. The address byte is clocked into the DS3904/DS3905 MSB to LSB. For the DS3904, the address byte consists of 101000 binary followed by A0 then the R/W bit. If the R/W bit is high, a read operation is initiated. For the DS3905, the address byte consists of 1010 binary followed by A2, A1, A0 then the R/W bit. If the R/W bit is low, a write operation is initiated. For a device to become active, the value of the address bits must be the same as the hard-wired address pins on the DS3904/DS3905. Upon a match of written and hard-wired addresses, the DS3904/DS3905 output a zero for one clock cycle as an acknowledge. If the address does not match, the DS3904/DS3905 return to a low-power mode.

Write Operations

After receiving a matching device address byte with the R/W bit set low, the device goes into the write mode of operation. The master must transmit an 8-bit EEPROM memory address to the device to define the address

where the data is to be written. After the byte has been received, the DS3904/DS3905 transmit a zero for one clock cycle to acknowledge that the memory address has been received. The master must then transmit an 8-bit data word to be written into this memory address. The DS3904/DS3905 again transmit a zero for one clock cycle to acknowledge the receipt of the data byte. At this point, the master must terminate the write operation with a stop condition. The DS3904/DS3905 then enter an internally timed write process t_w to the EEPROM memory. All inputs are disabled during this write cycle.

Acknowledge Polling

Once a EEPROM write is initiated, the part will not acknowledge until the cycle is complete. Another option is to wait the maximum write cycle delay before initiating another write cycle.

Read Operations

After receiving a matching address byte with the R/W bit set high, the device goes into the read mode of operation. A read requires a dummy byte write sequence to load in the register address. Once the device address and data address bytes are clocked in by the master, and acknowledged by the DS3904/DS3905, the master must generate another start condition (repeated start). The master now initiates a read by sending the device address with the R/W bit set high. The DS3904/DS3905 acknowledge the device address and serially clock out the data byte. The master responds with a NACK and generates a stop condition afterwards.

See Figures 4 and 5 for command and data byte structures as well as read and write examples.

2-Wire Serial Port Operation

The 2-wire serial port interface supports a bidirectional data transmission protocol with device addressing. A device that sends data on the bus is defined as a transmitter, and a device receiving data as a receiver. The device that controls the message is called a master. The devices that are controlled by the master are slaves. The bus must be controlled by a master device that generates the SCL, controls the bus access, and generates the start and stop conditions. The DS3904/DS3905 operate as slaves on the 2-wire bus. Connections to the bus are made through SCL and open-drain SDA lines. The following I/O terminals control the 2-wire serial port: SDA, SCL, and A0. The DS3905 uses two additional address pins A1 and A2 to control the 2-wire serial port. Timing diagrams for the 2-wire serial port can be found in Figures 2 and 3. Timing information for the 2-wire serial port is provided in the AC Electrical Characteristics table for 2-wire serial communications.

Triple 128-Position Nonvolatile Digital Variable Resistor/Switch

DS3904/DS3905

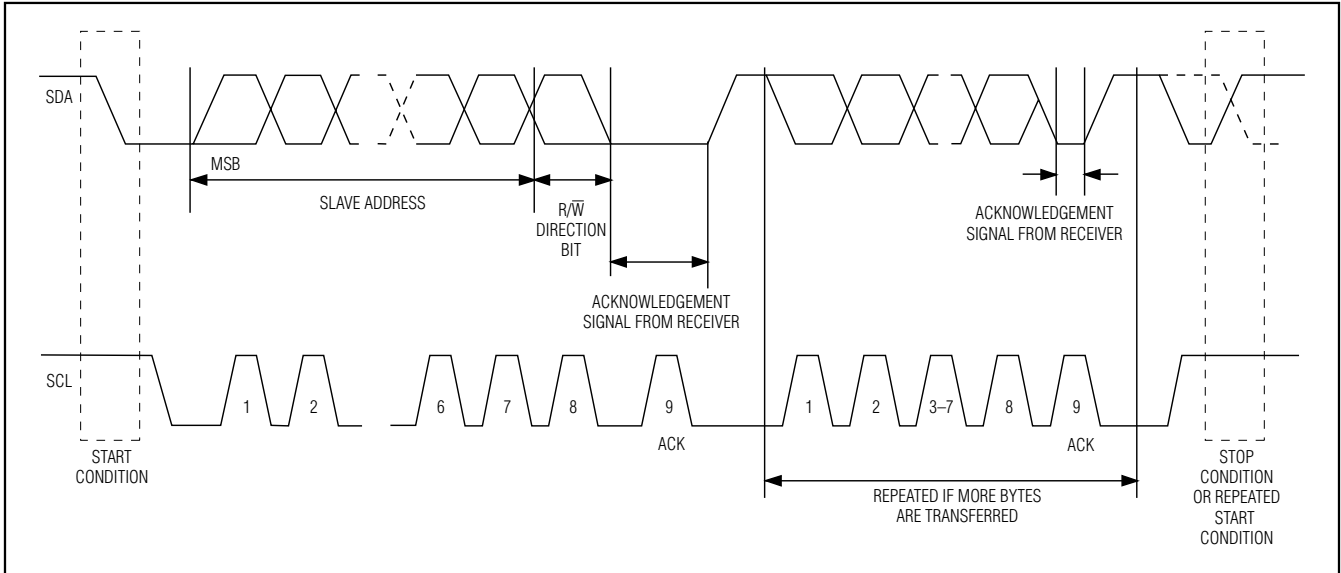

Figure 2. 2-Wire Data Transfer Protocol

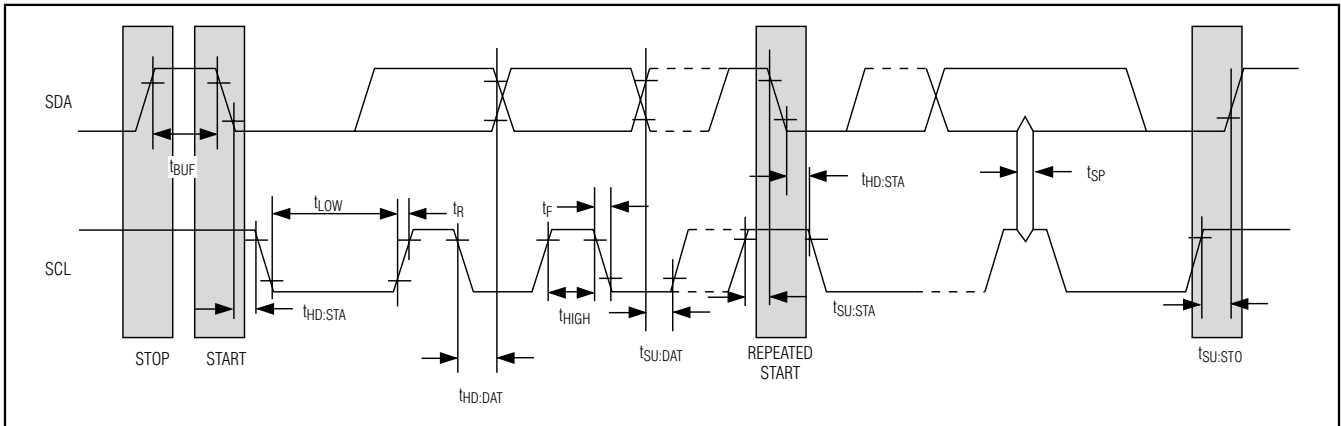

Figure 3. 2-Wire AC Characteristics

The following bus protocol has been defined:

Data transfer can be initiated only when the bus is not busy.

During data transfer, the data line must remain stable whenever the clock line is high. Changes in the data line while the clock line is high are interpreted as control signals.

Accordingly, the following bus conditions have been defined:

Bus Not Busy: Both data and clock lines remain high.

Start Data Transfer: A change in the state of the data line from high to low while the clock is high defines a start condition.

Stop Data Transfer: A change in the state of the data line from low to high while the clock line is high defines the stop condition.

Data Valid: The state of the data line represents valid data when, after a start condition, the data line is stable for the duration of the high period of the clock signal. The data on the line can be changed during the low period of the clock signal. There is

Triple 128-Position Nonvolatile Digital Variable Resistor/Switch

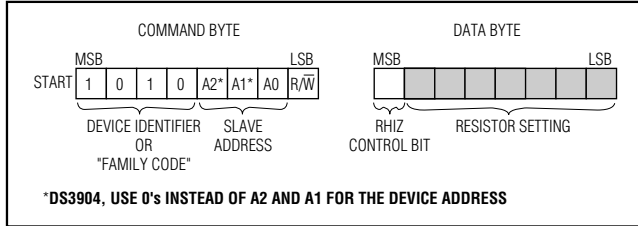

Figure 4. Command and Data Byte Structures

one clock pulse per bit of data. Figures 2 and 3 detail how data transfer is accomplished on the 2-wire bus. Depending upon the state of the R/W bit, two types of data transfer are possible.

Each data transfer is initiated with a start condition and terminated with a stop condition. The number of data bytes transferred between start and stop conditions is not limited and is determined by the master device. The information is transferred byte-wise and each receiver acknowledges with a ninth bit.

Within the bus specifications, a regular mode (100kHz clock rate) and a fast mode (400kHz clock rate) are defined. The DS3904/DS3905 work in both modes.

Acknowledge: Each receiving device, when addressed, generates an acknowledge after the byte has been received. The master device must generate an extra clock pulse that is associated with this acknowledge bit.

A device that acknowledges must pull down the SDA line during the acknowledge clock pulse in such a way that the SDA line is a stable low during the high period of the acknowledge-related clock pulse. Of course, setup and hold times must be taken into account. A master must signal an end of data to the slave by not generating an acknowledge bit on the last byte that has been clocked out of the slave. In this case, the slave must leave the data line high to enable the master to generate the stop condition.

Data transfer from a master transmitter to a slave receiver. The first byte transmitted by the master is the command/control byte. Next follows a number of data bytes. The slave returns an acknowledge bit after each received byte.

Data transfer from a slave transmitter to a master receiver. The master transmits the first byte (the command/control byte) to the slave. The slave then returns an acknowledge bit. Next follows the data byte transmitted by the slave to the master. The master returns NACK followed by a stop.

The master device generates all serial clock pulses and the start and stop conditions. A transfer is ended with a stop condition or with a repeated start condition. Since a repeated start condition is also the beginning of the next serial transfer, the bus is not released.

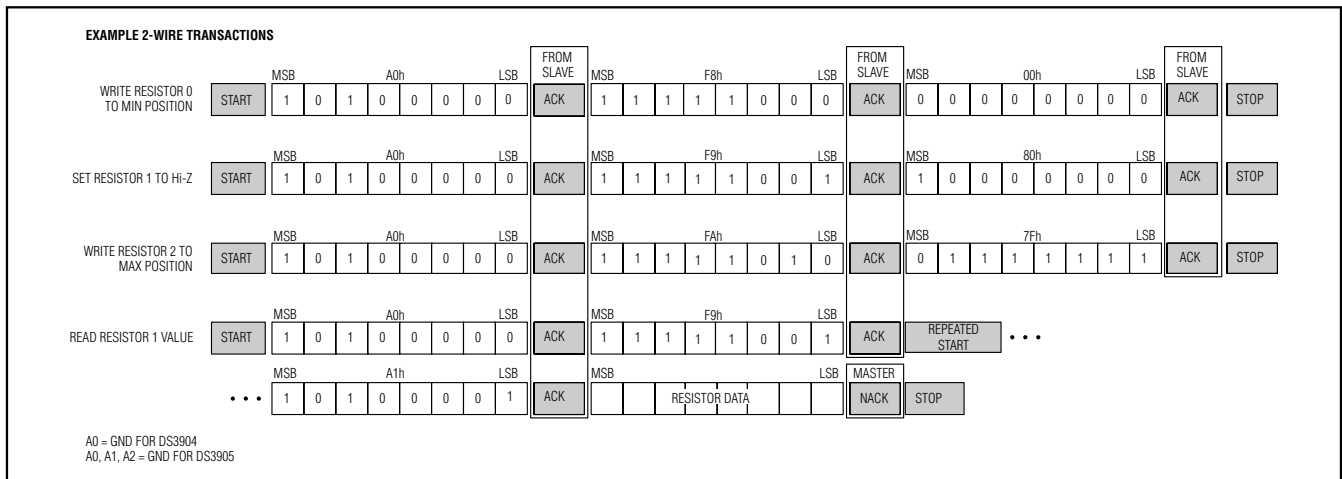

Figure 5. Example 2-Wire Transactions

Triple 128-Position Nonvolatile Digital Variable Resistor/Switch

DS3904/DS3905

The DS3904/DS3905 can operate in the following three modes:

- 1) **Slave Receiver Mode:** Serial data and clock are received through SDA and SCL, respectively. After each byte is received, an acknowledge bit is transmitted. Start and stop conditions are recognized as the beginning and end of a serial transfer. Address recognition is performed by hardware after the slave (device) address and direction bit has been received.
- 2) **Slave Transmitter Mode:** The first byte is received and handled as in the slave receiver mode. However, in this mode the direction bit indicates that the transfer direction is reversed. Serial data is transmitted on SDA by the DS3904/DS3905 while the serial clock is input on SCL. Start and stop conditions are recognized as the beginning and end of a serial transfer.
- 3) **Slave Address:** The command/control byte is the first byte received following the start condition from the master device. The command/control byte consists of a 4-bit device identifier. For the DS3904, the identifier is followed by the device-select bits 0, 0, and A0. For the DS3905, the identifier is followed by the device-select bits A2, A1, A0. The device identifier is used by the master device to select which device is to be accessed. When reading or writing the DS3904/DS3905, the device-select bits must match the device-select pin(s). The last bit of the command/control byte (R/\overline{W}) defines the operation to be performed. When set to a '1', a read operation is selected, and when set to a '0', a write operation is selected.

Following the start condition, the DS3904/DS3905 monitor the SDA bus checking the device-type identifier being transmitted. Upon receiving the control code, the appropriate device address bit, and the read/write bit, the slave device outputs an acknowledge signal on the SDA line.

Applications Information

Power-Supply Decoupling

To achieve the best results when using the DS3904/DS3905, decouple the power supply with a 0.01 μ F or 0.1 μ F capacitor. Use a high-quality ceramic surface-mount capacitor. Surface-mount components minimize lead inductance, which improves performance, and ceramic capacitors tend to have adequate high-frequency response for decoupling applications.

High Resistor Terminal Voltage

It is possible to have a voltage on the resistor-high terminals that is higher than the voltage connected to V_{CC} . For instance, connecting V_{CC} to 3.0V while one or more of the resistor high terminals are connected to 5.0V allows a 3V system to control a 5V system. The 5.5V maximum still applies to the limit on the resistor high terminals regardless of the voltage present on V_{CC} .

Package Information

For the latest package outline information, go to www.maxim-ic.com/DallasPackInfo.

Maxim cannot assume responsibility for use of any circuitry other than circuitry entirely embodied in a Maxim product. No circuit patent licenses are implied. Maxim reserves the right to change the circuitry and specifications without notice at any time.

Maxim Integrated Products, 120 San Gabriel Drive, Sunnyvale, CA 94086 408-737-7600 _____ 11

Mouser Electronics

Authorized Distributor

Click to View Pricing, Inventory, Delivery & Lifecycle Information:

[Maxim Integrated:](#)

[DS3904U-020+](#) [DS3905U-020+](#) [DS3905U-020+T&R](#) [DS3904U-010+](#) [DS3904U-010+T&R](#) [DS3904U-020+T&R](#)
[DS3904U-020/T&R](#)