

IR Receiver Modules for Remote Control Systems

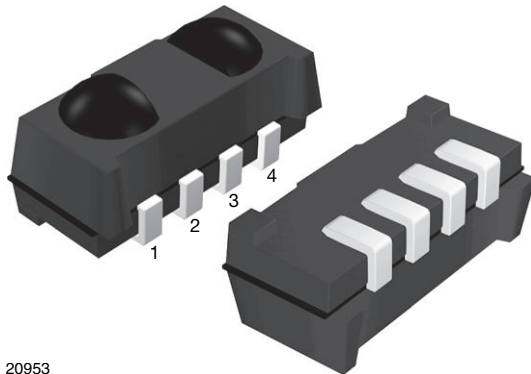

20953

LINKS TO ADDITIONAL RESOURCES



DESCRIPTION

The TSOP773.., TSOP775.. series are a two lens miniaturized receiver module for infrared remote control systems. One PIN diode per lens and a preamplifier are assembled on a leadframe, the epoxy lens cap contains an IR filter.

The TSOP773.. series devices are optimized to suppress almost all spurious pulses from Wi-Fi and CFL sources. They may suppress some data signals if continuously transmitted.

New designs should prefer the TSOP773.. series containing the newer AGC3. The TSOP775.. series are useful to suppress even extreme levels of optical noise, but may also suppress some data signals. Please check compatibility with your codes.

These components have not been qualified according to automotive specifications.

FEATURES

- Improved immunity against HF and RF noise
- Continuous data transmission possible
- Low supply current
- Photo detector and preamplifier in one package
- Internal filter for PCM frequency
- Supply voltage: 2.5 V to 5.5 V
- Improved immunity against ambient light
- Capable of side or top view
- Insensitive to supply voltage ripple and noise
- Two lenses for high sensitivity and wide receiving angle
- Material categorization: for definitions of compliance please see www.vishay.com/doc?99912



MECHANICAL DATA

Pinning:

1, 4 = GND, 2 = V_S , 3 = OUT

ORDERING CODE

Taping:

TSOP77...TT - top view taped, 2200 pcs/reel

TSOP77...TR - side view taped, 2300 pcs/reel

BLOCK DIAGRAM

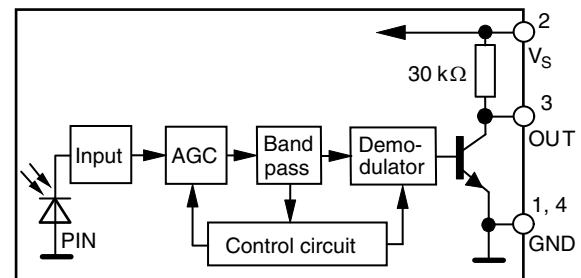

20445-1

APPLICATION CIRCUIT

17170-11

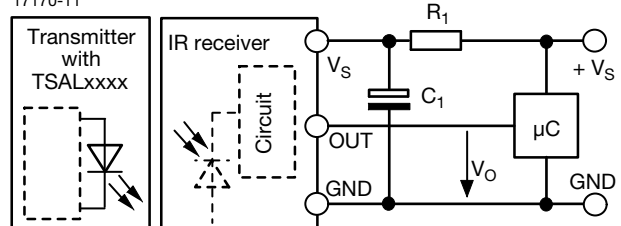

R_1 and C_1 recommended to reduce supply ripple for $V_S < 2.8$ V



PARTS TABLE			
AGC		NOISY ENVIRONMENTS AND SHORT BURSTS (AGC3)	VERY NOISY ENVIRONMENTS AND SHORT BURSTS (AGC5)
Carrier frequency	30 kHz	TSOP77330	TSOP77530
	33 kHz	TSOP77333	TSOP77533
	36 kHz	TSOP77336 (1)	TSOP77536
	38 kHz	TSOP77338 (2)(3)(4)(5)	TSOP77538
	40 kHz	TSOP77340	TSOP77540
	56 kHz	TSOP77356	TSOP77556
Package		Heimdall	
Pinning		1, 4 = GND, 2 = V _S , 3 = OUT	
Dimensions (mm)		6.8 W x 3.0 H x 3.2 D	
Mounting		SMD	
Application		Remote control	
Best choice for		(1) MCIR (2) Mitsubishi (3) RECS-80 Code (4) r-map (5) XMP-1, XMP-2	
Special options		<ul style="list-style-type: none"> Extended temperature range: www.vishay.com/doc?82738 Narrow optical filter: www.vishay.com/doc?81590 Wide optical filter: www.vishay.com/doc?82726 	

ABSOLUTE MAXIMUM RATINGS				
PARAMETER	TEST CONDITION	SYMBOL	VALUE	UNIT
Supply voltage		V _S	-0.3 to +6	V
Supply current		I _S	5	mA
Output voltage		V _O	-0.3 to 5.5	V
Voltage at output to supply		V _S - V _O	-0.3 to (V _S + 0.3)	V
Output current		I _O	5	mA
Junction temperature		T _j	100	°C
Storage temperature range		T _{stg}	-25 to +85	°C
Operating temperature range		T _{amb}	-25 to +85	°C
Power consumption	T _{amb} ≤ 85 °C	P _{tot}	10	mW
Soldering temperature	t ≤ 10 s, 1 mm from case	T _{sdl}	260	°C

Note

- Stresses beyond those listed under “Absolute Maximum Ratings” may cause permanent damage to the device. This is a stress rating only and functional operation of the device at these or any other conditions beyond those indicated in the operational sections of this specification is not implied. Exposure to absolute maximum rating conditions for extended periods may affect the device reliability

ELECTRICAL AND OPTICAL CHARACTERISTICS (T _{amb} = 25 °C, unless otherwise specified)						
PARAMETER	TEST CONDITION	SYMBOL	MIN.	TYP.	MAX.	UNIT
Supply voltage		V _S	2.5	-	5.5	V
Supply current	V _S = 5 V, E _v = 0	I _{SD}	0.55	0.7	0.9	mA
	E _v = 40 klx, sunlight	I _{SH}	-	0.8	-	mA
Transmission distance	E _v = 0, IR diode TSAL6200, I _F = 50 mA, test signal see Fig. 1	d	-	18	-	m
Output voltage low	I _{OSL} = 0.5 mA, E _e = 0.7 mW/m ² , test signal see Fig. 1	V _{OSL}	-	-	100	mV
Minimum irradiance	Pulse width tolerance: t _{pi} - 5/f _o < t _{po} < t _{pi} + 6/f _o , test signal see Fig. 1	E _e min.	-	0.2	0.4	mW/m ²
Maximum irradiance	t _{pi} - 5/f _o < t _{po} < t _{pi} + 6/f _o , test signal see Fig. 1	E _e max.	50	-	-	W/m ²
Directivity	Angle of half transmission distance	φ _{1/2}	-	± 50	-	°

TYPICAL CHARACTERISTICS (T_{amb} = 25 °C, unless otherwise specified)

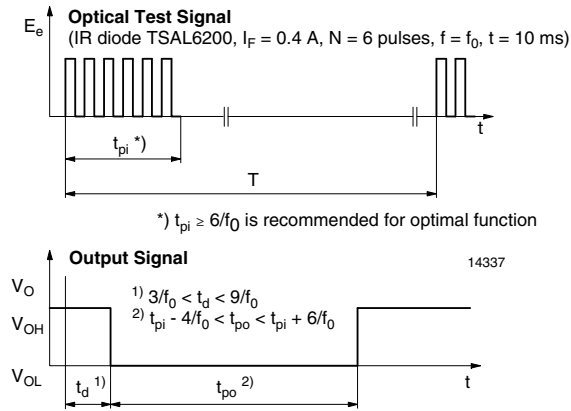

Fig. 1 - Output Active Low

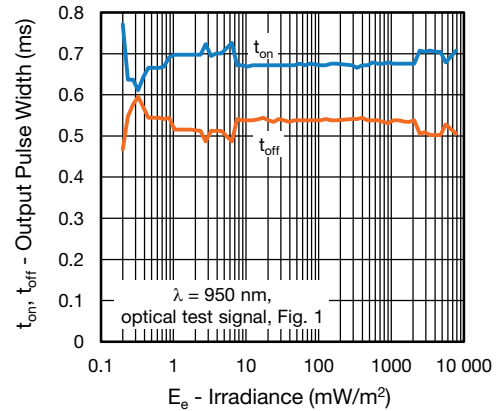

Fig. 4 - Output Pulse Diagram

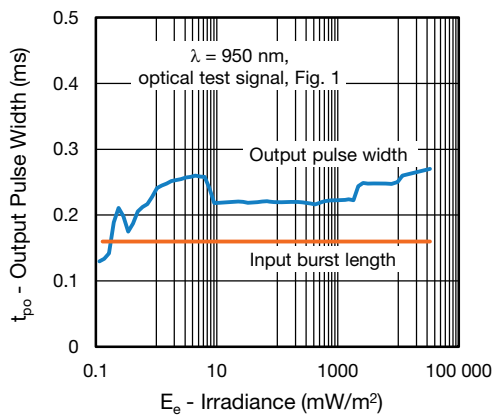

Fig. 2 - Pulse Length and Sensitivity in Dark Ambient

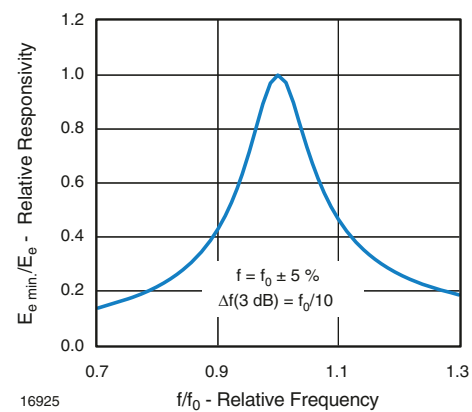

Fig. 5 - Frequency Dependence of Responsivity

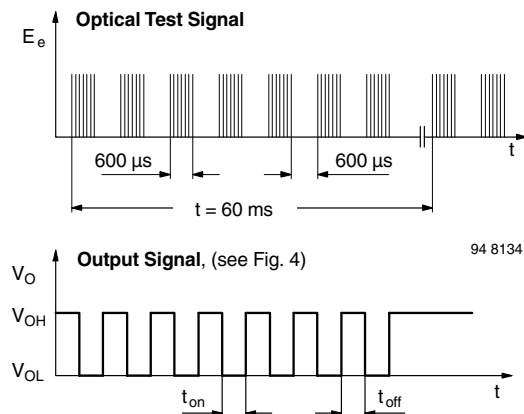

Fig. 3 - Output Function

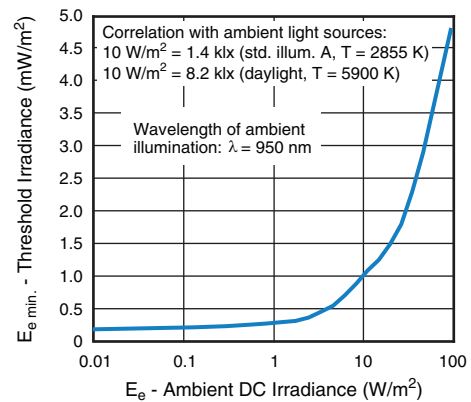

Fig. 6 - Sensitivity in Bright Ambient

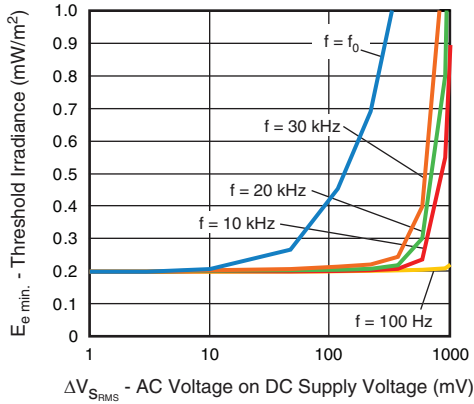

Fig. 7 - Sensitivity vs. Supply Voltage Disturbances

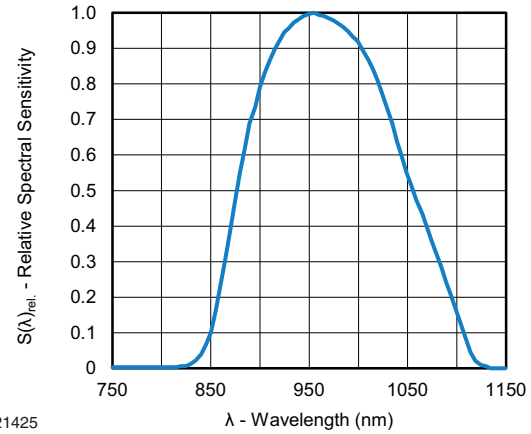

Fig. 10 - Relative Spectral Sensitivity vs. Wavelength

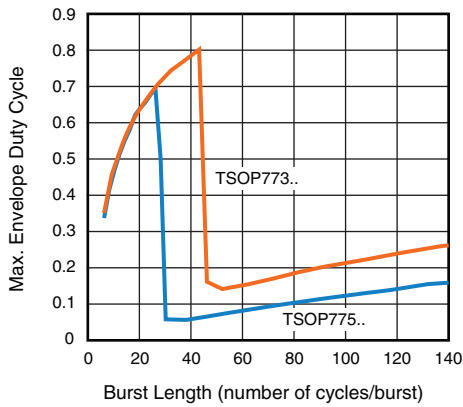

Fig. 8 - Max. Envelope Duty Cycle vs. Burst Length

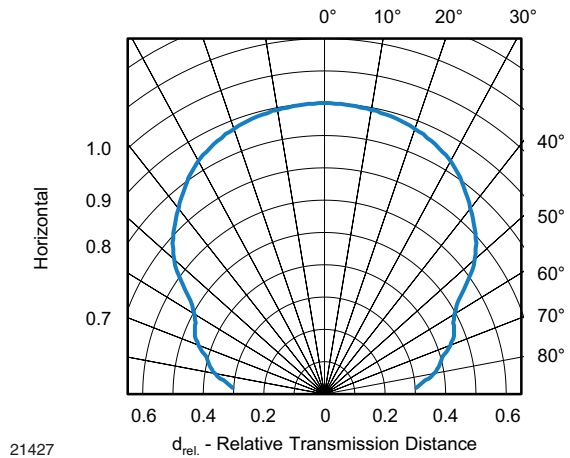

Fig. 11 - Horizontal Directivity

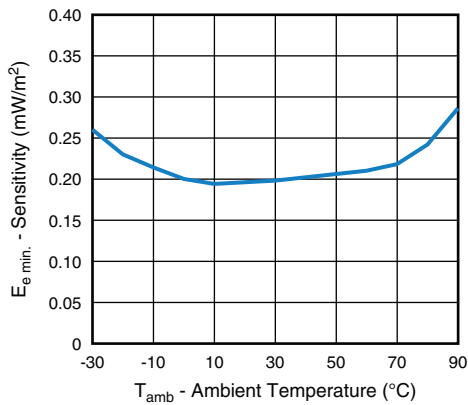

Fig. 9 - Sensitivity vs. Ambient Temperature

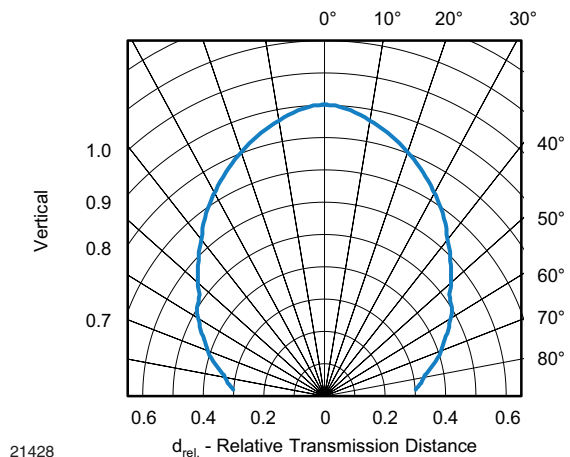

Fig. 12 - Vertical Directivity

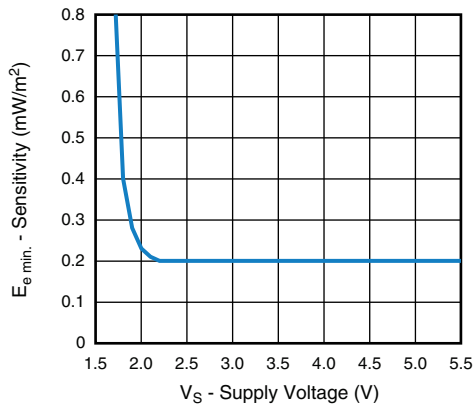

Fig. 1 Sensitivity vs. Supply Voltage

SUITABLE DATA FORMAT

These products are designed to suppress spurious output pulses due to noise or disturbance signals. Data and disturbance signals can be distinguished by the devices according to carrier frequency, burst length and envelope duty cycle. The data signal should be close to the band-pass center frequency (e.g. 38 kHz) and fulfill the conditions in the table below.

When a data signal is applied to the IR receiver in the presence of a disturbance signal, the sensitivity of the receiver is reduced to insure that no spurious pulses are present at the output. Some examples of disturbance signals which are suppressed are:

- DC light (e.g. from tungsten bulb or sunlight)
- Continuous signals at any frequency
- Modulated IR pattern from common fluorescent lamps (example of noise pattern is shown in Fig. 13 or Fig. 14)
- 2.4 GHz and 5 GHz Wi-Fi

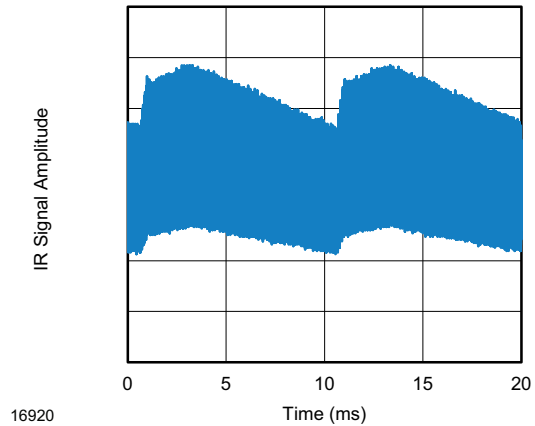

Fig. 13 - IR Disturbance from Fluorescent Lamp With Low Modulation

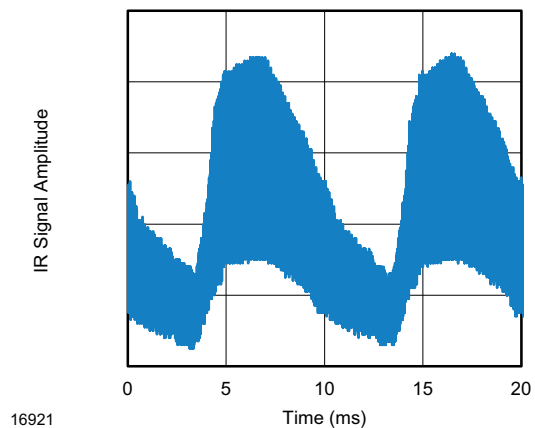

Fig. 14 - IR Disturbance from Fluorescent Lamp With High Modulation

	TSOP773..	TSOP775..
Minimum burst length	6 cycles/burst	6 cycles/burst
After each burst of length a minimum gap time is required of	6 to 35 cycles ≥ 10 cycles	6 to 24 cycles ≥ 10 cycles
For bursts greater than a minimum gap time in the data stream is needed of	35 cycles > 4 x burst length	24 cycles > 25 ms
Maximum number of continuous short bursts/second	2000	2000
MCIR code	Preferred	Yes
XMP-1, XMP-2 code	Preferred	Yes
Sejin 4 ppm	Preferred	Yes
Suppression of interference from fluorescent lamps	Mild and complex disturbance patterns are suppressed (example: signal pattern of Fig. 13 and Fig. 14)	Critical disturbance patterns are suppressed, e.g. highly dimmed LCDs

Note

- For data formats with long bursts please see the datasheet for TSOP772.., TSOP774..

PACKAGE DIMENSIONS in millimeters

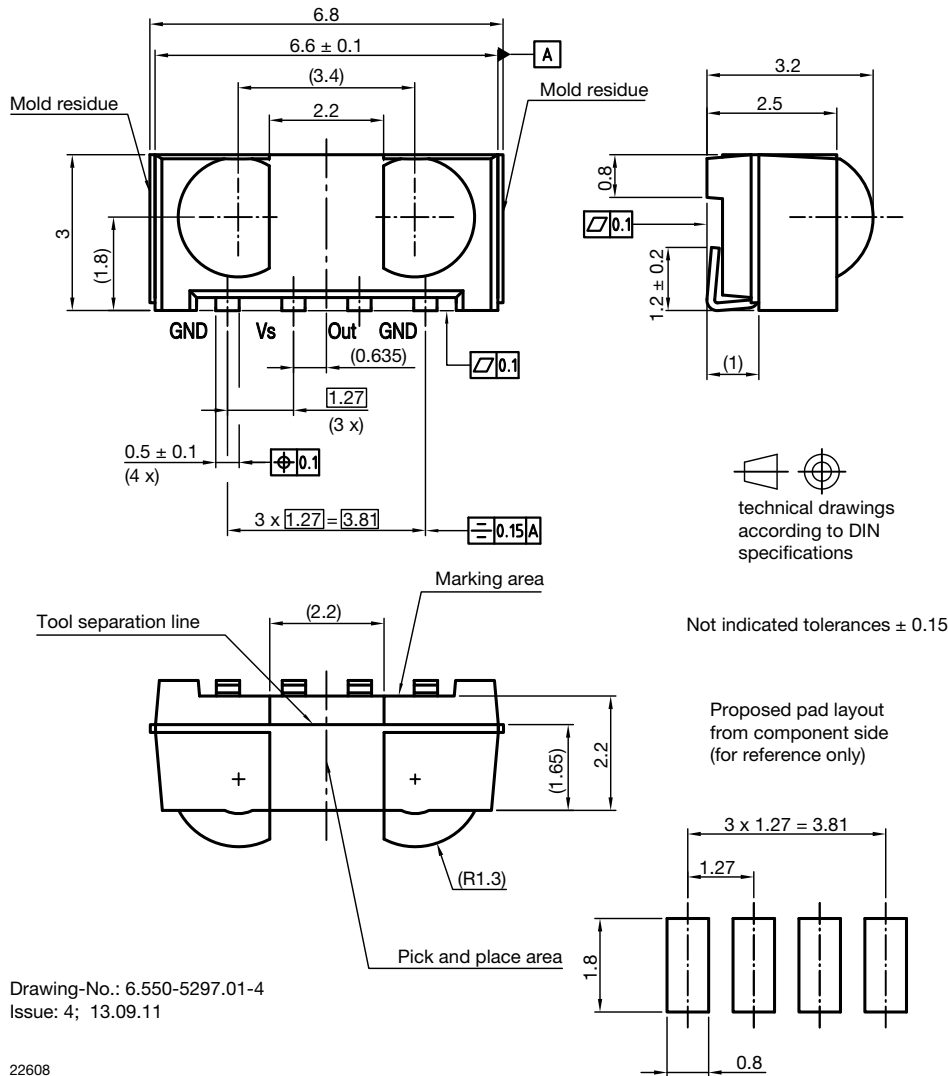

Drawing-No.: 6.550-5297.01-4
Issue: 4; 13.09.11

22608

ASSEMBLY INSTRUCTIONS

Reflow Soldering

- Reflow soldering must be done within 72 h while stored under a max. temperature of 30 °C, 60 % RH after opening the dry pack envelope
- Set the furnace temperatures for pre-heating and heating in accordance with the reflow temperature profile as shown in the diagram. Exercise extreme care to keep the maximum temperature below 260 °C. The temperature shown in the profile means the temperature at the device surface. Since there is a temperature difference between the component and the circuit board, it should be verified that the temperature of the device is accurately being measured
- Handling after reflow should be done only after the work surface has been cooled off

Manual Soldering

- Use a soldering iron of 25 W or less. Adjust the temperature of the soldering iron below 300 °C
- Finish soldering within 3 s
- Handle products only after the temperature has cooled off



VISHAY LEAD (Pb)-FREE REFLOW SOLDER PROFILE

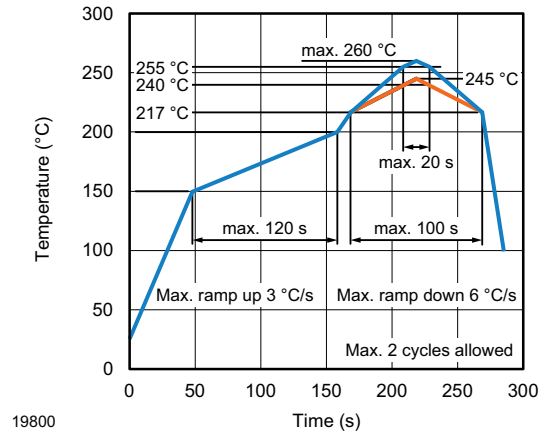

TAPING VERSION TSOP..TR DIMENSIONS in millimeters

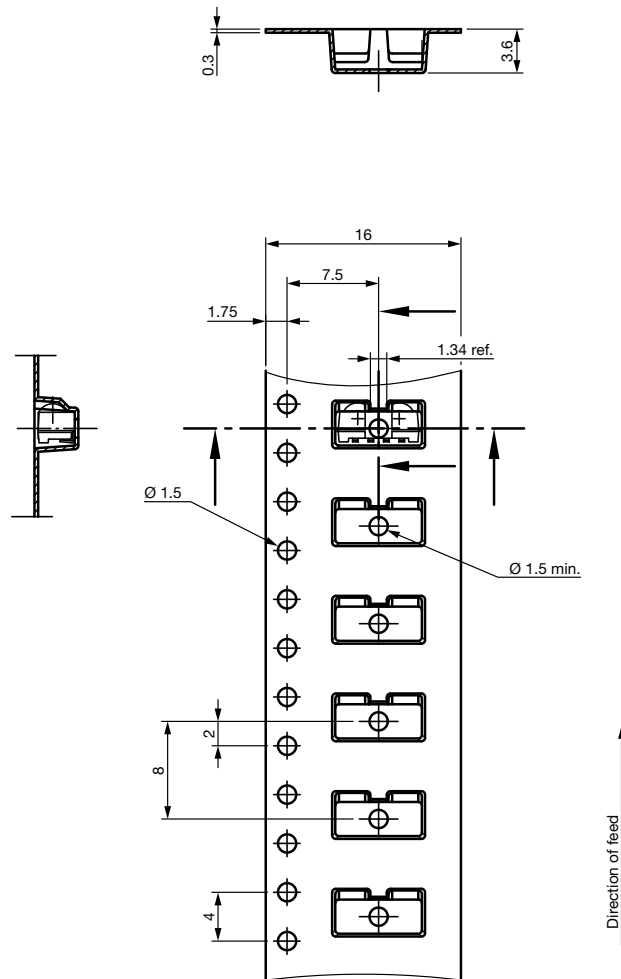

Drawing-No.: 9.700-5337.01-4
Issue: 2; 06.10.15

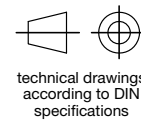



TAPING VERSION TSOP..TT DIMENSIONS in millimeters

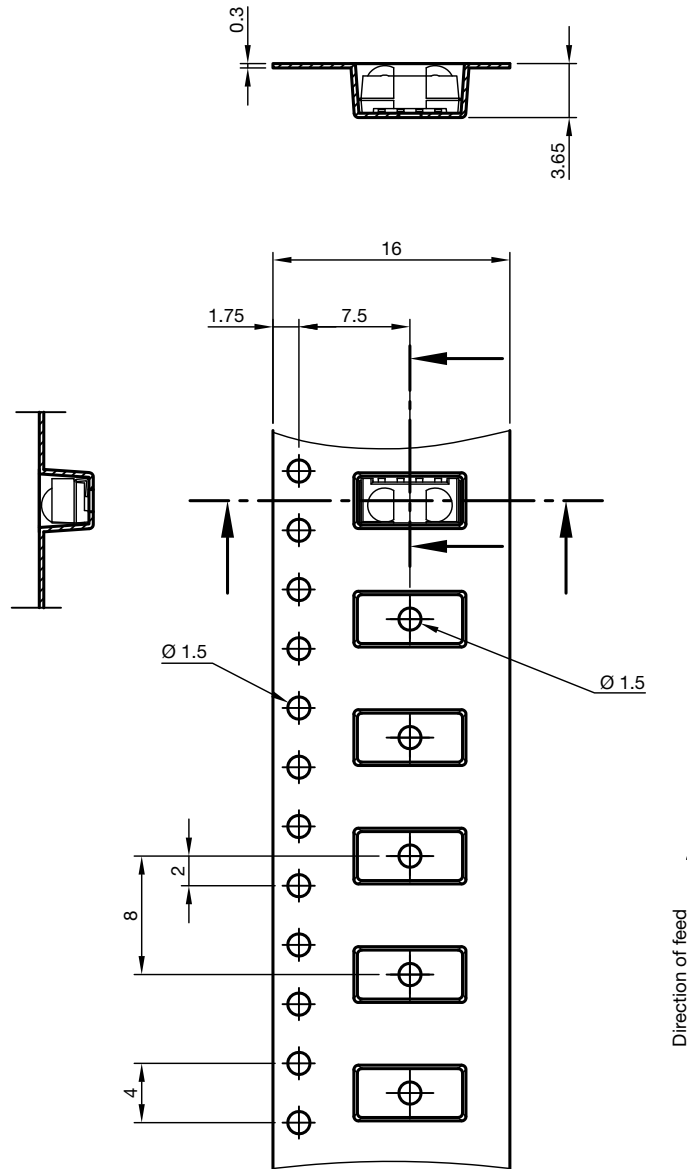

Drawing-No.: 9.700-5338.01-4
Issue: 4; 12.06.13

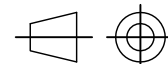

technical drawings
according to DIN
specifications

REEL DIMENSIONS in millimeters

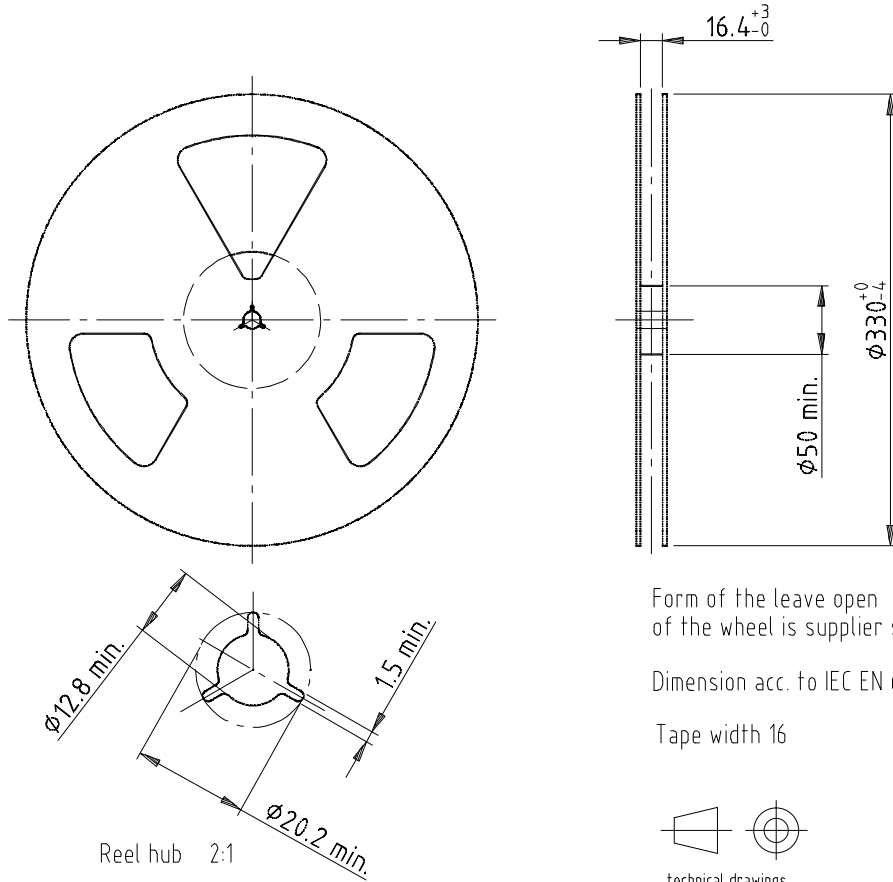

Form of the leave open of the wheel is supplier specific.

Dimension acc. to IEC EN 60 286-3

Tape width 16

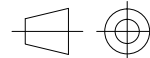

technical drawings according to DIN specifications

Drawing-No.: 9.800-5052.V2-4

Issue: 1; 07.05.02

16734

LEADER AND TRAILER DIMENSIONS in millimeters

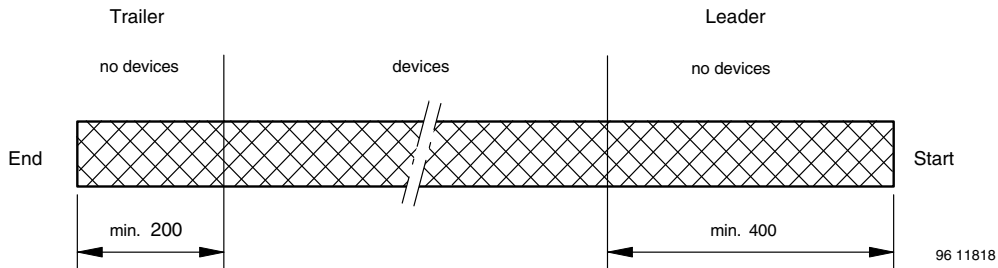

COVER TAPE PEEL STRENGTH

According to DIN EN 60286-3

0.1 N to 1.3 N

300 ± 10 mm/min.

165° to 180° peel angle

OUTER PACKAGING

The sealed reel is packed into a pizza box.

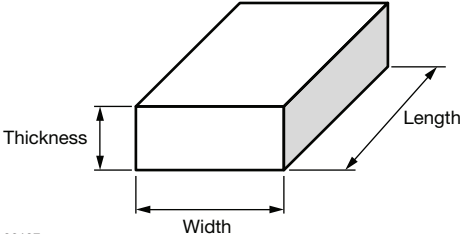
CARTON BOX DIMENSIONS in millimeters			
			
	THICKNESS	WIDTH	LENGTH
Pizza box (SMD and heimdall) (taping in reels)	50	340	340

LABEL
Standard bar code labels for finished goods

The standard bar code labels are product labels and used for identification of goods. The finished goods are packed in final packing area. The standard packing units are labeled with standard bar code labels before transported as finished goods to warehouses. The labels are on each packing unit and contain Vishay Semiconductor GmbH specific data.

VISHAY SEMICONDUCTOR GmbH STANDARD BAR CODE PRODUCT LABEL (finished goods)		
PLAIN WRITING	ABBREVIATION	LENGTH
Item-description	-	18
Item-number	INO	8
Selection-code	SEL	3
LOT-/serial-number	BATCH	10
Data-code	COD	3 (YWW)
Plant-code	PTC	2
Quantity	QTY	8
Accepted by	ACC	-
Packed by	PCK	-
Mixed code indicator	MIXED CODE	-
Origin	xxxxxxx+	Company logo
LONG BAR CODE TOP	TYPE	LENGTH
Item-number	N	8
Plant-code	N	2
Sequence-number	X	3
Quantity	N	8
Total length	-	21
SHORT BAR CODE BOTTOM	TYPE	LENGTH
Selection-code	X	3
Data-code	N	3
Batch-number	X	10
Filter	-	1
Total length	-	17



DRY PACKING

The reel is packed in an anti-humidity bag to protect the devices from absorbing moisture during transportation and storage.

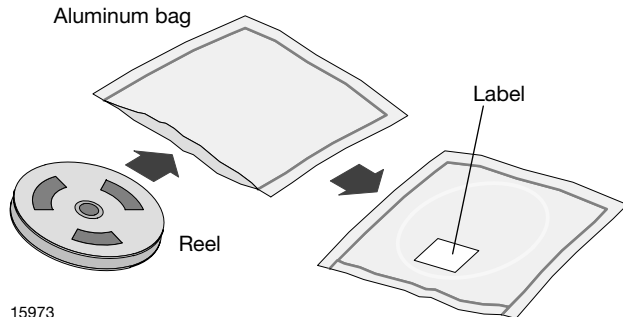

FINAL PACKING

The sealed reel is packed into a cardboard box.

RECOMMENDED METHOD OF STORAGE

Dry box storage is recommended as soon as the aluminum bag has been opened to prevent moisture absorption. The following conditions should be observed, if dry boxes are not available:

- Storage temperature 10 °C to 30 °C
- Storage humidity ≤ 60 % RH max.

After more than 72 h under these conditions moisture content will be too high for reflow soldering.

In case of moisture absorption, the devices will recover to the former condition by drying under the following condition:

- 192 h at 40 °C + 5 °C / - 0 °C and < 5 % RH (dry air / nitrogen) or
- 96 h at 60 °C + 5 °C and < 5 % RH for all device containers or
- 24 h at 125 °C + 5 °C not suitable for reel or tubes.

An EIA JEDEC® standard J-STD-020 level 4 label is included on all dry bags.

ESD PRECAUTION

Proper storage and handling procedures should be followed to prevent ESD damage to the devices especially when they are removed from the antistatic shielding bag. Electrostatic sensitive devices warning labels are on the packaging.

VISHAY SEMICONDUCTORS STANDARD BAR CODE LABELS

The Vishay Semiconductors standard bar code labels are printed at final packing areas. The labels are on each packing unit and contain Vishay Semiconductors specific data.

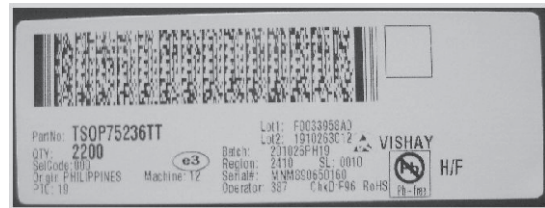

22178

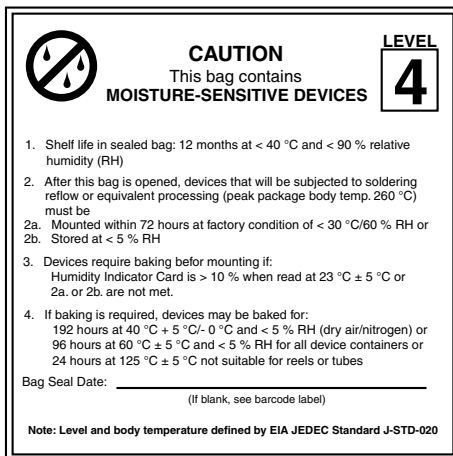

22522

EIA JEDEC standard J-STD-020 level 4 is included on all dry bags



Disclaimer

ALL PRODUCT, PRODUCT SPECIFICATIONS AND DATA ARE SUBJECT TO CHANGE WITHOUT NOTICE TO IMPROVE RELIABILITY, FUNCTION OR DESIGN OR OTHERWISE.

Vishay Intertechnology, Inc., its affiliates, agents, and employees, and all persons acting on its or their behalf (collectively, "Vishay"), disclaim any and all liability for any errors, inaccuracies or incompleteness contained in any datasheet or in any other disclosure relating to any product.

Vishay makes no warranty, representation or guarantee regarding the suitability of the products for any particular purpose or the continuing production of any product. To the maximum extent permitted by applicable law, Vishay disclaims (i) any and all liability arising out of the application or use of any product, (ii) any and all liability, including without limitation special, consequential or incidental damages, and (iii) any and all implied warranties, including warranties of fitness for particular purpose, non-infringement and merchantability.

Statements regarding the suitability of products for certain types of applications are based on Vishay's knowledge of typical requirements that are often placed on Vishay products in generic applications. Such statements are not binding statements about the suitability of products for a particular application. It is the customer's responsibility to validate that a particular product with the properties described in the product specification is suitable for use in a particular application. Parameters provided in datasheets and / or specifications may vary in different applications and performance may vary over time. All operating parameters, including typical parameters, must be validated for each customer application by the customer's technical experts. Product specifications do not expand or otherwise modify Vishay's terms and conditions of purchase, including but not limited to the warranty expressed therein.

Hyperlinks included in this datasheet may direct users to third-party websites. These links are provided as a convenience and for informational purposes only. Inclusion of these hyperlinks does not constitute an endorsement or an approval by Vishay of any of the products, services or opinions of the corporation, organization or individual associated with the third-party website. Vishay disclaims any and all liability and bears no responsibility for the accuracy, legality or content of the third-party website or for that of subsequent links.

Except as expressly indicated in writing, Vishay products are not designed for use in medical, life-saving, or life-sustaining applications or for any other application in which the failure of the Vishay product could result in personal injury or death. Customers using or selling Vishay products not expressly indicated for use in such applications do so at their own risk. Please contact authorized Vishay personnel to obtain written terms and conditions regarding products designed for such applications.

No license, express or implied, by estoppel or otherwise, to any intellectual property rights is granted by this document or by any conduct of Vishay. Product names and markings noted herein may be trademarks of their respective owners.