



Chip Beads

For signal line

MMZ-E series

MMZ0603-E	0603[0201 inch]*
MMZ1005-E	1005[0402 inch]

* Dimensions Code JIS[EIA]

REMINDERS FOR USING THESE PRODUCTS

Before using these products, be sure to request the delivery specifications.

SAFETY REMINDERS

Please pay sufficient attention to the warnings for safe designing when using these products.

REMINDERS

- The storage period is less than 12 months. Be sure to follow the storage conditions (Temperature: 5 to 40°C, Humidity: 10 to 75% RH or less).
If the storage period elapses, the soldering of the terminal electrodes may deteriorate.
- Do not use or store in locations where there are conditions such as gas corrosion (salt, acid, alkali, etc.).
- Before soldering, be sure to preheat components.
The preheating temperature should be set so that the temperature difference between the solder temperature and chip temperature does not exceed 150°C.
- Soldering corrections after mounting should be within the range of the conditions determined in the specifications.
If overheated, a short circuit, performance deterioration, or lifespan shortening may occur.
- When embedding a printed circuit board where a chip is mounted to a set, be sure that residual stress is not given to the chip due to the overall distortion of the printed circuit board and partial distortion such as at screw tightening portions.
- Self heating (temperature increase) occurs when the power is turned ON, so the tolerance should be sufficient for the set thermal design.
- Carefully lay out the coil for the circuit board design of the non-magnetic shield type.
A malfunction may occur due to magnetic interference.
- Use a wrist band to discharge static electricity in your body through the grounding wire.
- Do not expose the products to magnets or magnetic fields.
- Do not use for a purpose outside of the contents regulated in the delivery specifications.
- The products listed on this catalog are intended for use in general electronic equipment (AV equipment, telecommunications equipment, home appliances, amusement equipment, computer equipment, personal equipment, office equipment, measurement equipment, industrial robots) under a normal operation and use condition.
The products are not designed or warranted to meet the requirements of the applications listed below, whose performance and/or quality require a more stringent level of safety or reliability, or whose failure, malfunction or trouble could cause serious damage to society, person or property.
If you intend to use the products in the applications listed below or if you have special requirements exceeding the range or conditions set forth in the each catalog, please contact us.

- (1) Aerospace/Aviation equipment
- (2) Transportation equipment (cars, electric trains, ships, etc.)
- (3) Medical equipment
- (4) Power-generation control equipment
- (5) Atomic energy-related equipment
- (6) Seabed equipment
- (7) Transportation control equipment

- (8) Public information-processing equipment
- (9) Military equipment
- (10) Electric heating apparatus, burning equipment
- (11) Disaster prevention/crime prevention equipment
- (12) Safety equipment
- (13) Other applications that are not considered general-purpose applications

When designing your equipment even for general-purpose applications, you are kindly requested to take into consideration securing protection circuit/device or providing backup circuits in your equipment.

Chip Beads

For signal line

Product compatible with RoHS directive

Halogen-free

Compatible with lead-free solders

Overview of the MMZ-E Series

FEATURES

- Noise reduction solution for general signal lines.
- Compared to the conventional MMZ Series, has a wider frequency range impedance value up to a high frequency range.
- Lineup includes 2 sizes; 0603 and 1005.
- Achieves various frequency characteristics by using 4 materials with different features.
- Multilayer integration monolithic structure makes it highly reliable.
- There is no directivity.

APPLICATION

- Smart phones, tablets, portable memory audio devices, various modules, PCs, note PCs, TVs, STBs, Blu-ray recorders, DSCs, and DVCs
- Signal line noise removal for high frequency / wide frequency range devices such as game machines.

PART NUMBER CONSTRUCTION

Series name	L×W×T Dimensions (mm)		Material name	Impedance (Ω) at 100MHz		Characteristic type	Packaging style		Internal code
MMZ	0603	0.6×0.3×0.3	S	601	600	E	T	Taping	□□□
	1005	1.0×0.5×0.5	A	102	1000				
			D						
			F						

OPERATING TEMPERATURE RANGE, PACKAGE QUANTITY, PRODUCT WEIGHT

Type	Temperature range		Package quantity	Individual weight
	Operating temperature*	Storage temperature**		
	(°C)	(°C)	(pieces/reel)	(mg)
MMZ0603-E	-55 to +125	-55 to +125	15,000	0.3
MMZ1005-E	-55 to +125	-55 to +125	10,000	1

* Operating temperature range includes self-temperature rise.

** The Storage temperature range is for after the circuit board is mounted.

- RoHS Directive Compliant Product: See the following for more details related to RoHS Directive compliant products. <http://www.tdk.co.jp/rohs/>
- Halogen-free: Indicates that Cl content is less than 900ppm, Br content is less than 900ppm, and that the total Cl and Br content is less than 1500ppm.

• All specifications are subject to change without notice.

Overview of the MMZ-E Series

RECOMMENDED REFLOW PROFILE



Preheating			Soldering		Peak	
Temp.	Temp.	Time	Temp.	Time	Temp.	Time
T1	T2	t1	T3	t2	T4	t3
150°C	180°C	60 to 120s	230°C	30 to 60s	250 to 260°C	10s

MMZ-E series

MMZ0603-E Type



SHAPE & DIMENSIONS

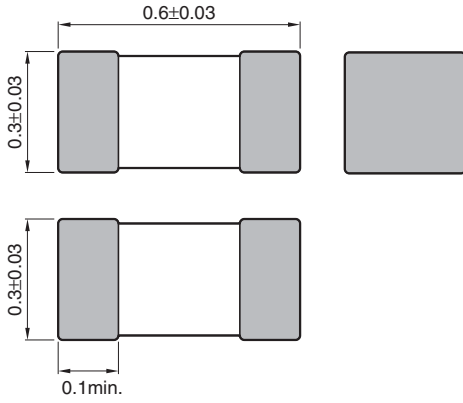

Dimensions in mm

RECOMMENDED LAND PATTERN

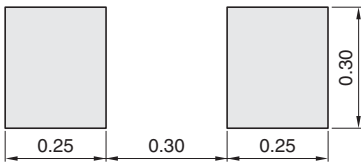

Dimensions in mm

• All specifications are subject to change without notice.

MMZ-E series **MMZ0603-E Type**

■ ELECTRICAL CHARACTERISTICS

□ CHARACTERISTICS SPECIFICATION TABLE

Impedance [100MHz]		[1GHz]		DC resistance (Ω)max.	Rated current (mA)max.	Part No.
(Ω)	Tolerance	(Ω)	Tolerance			
600	$\pm 25\%$	1000	$\pm 40\%$	1.60	150	MMZ0603S601ET□□□
1000	$\pm 25\%$	1800	$\pm 40\%$	2.60	125	MMZ0603S102ET□□□

○ Measurement equipment

Measurement item	Product No.	Manufacturer
Impedance	E4991A+16197	Agilent Technologies
DC resistance	Type-7556	Yokogawa

* Equivalent measurement equipment may be used.

MMZ-E series **MMZ0603-E Type**

■ ELECTRICAL CHARACTERISTICS

□ Z VS. FREQUENCY CHARACTERISTICS (BY SERIES)

MMZ0603S-E SERIES

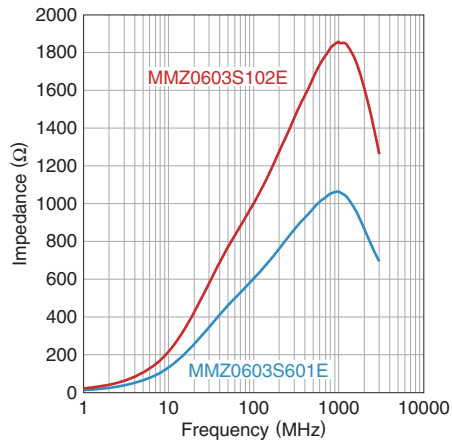

MMZ-E series **MMZ0603-E Type**

■ ELECTRICAL CHARACTERISTICS

□ Z, X, R VS. FREQUENCY CHARACTERISTICS

MMZ0603S601E

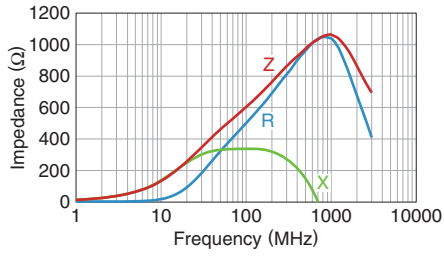

MMZ0603S102E

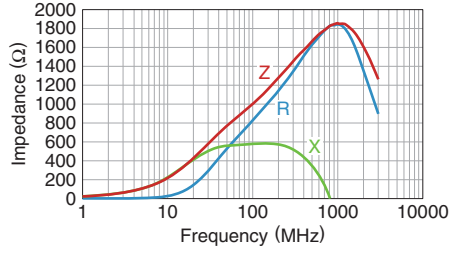

• All specifications are subject to change without notice.

MMZ-E series

MMZ1005-E Type



SHAPE & DIMENSIONS

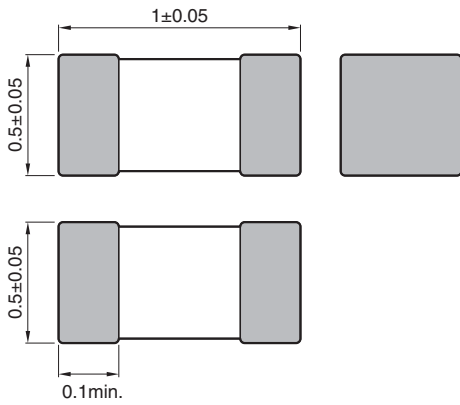

Dimensions in mm

RECOMMENDED LAND PATTERN

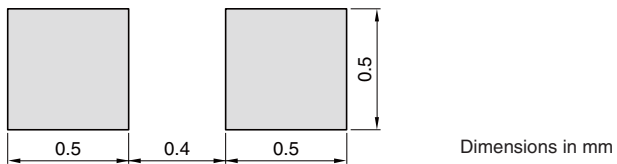

Dimensions in mm

• All specifications are subject to change without notice.

MMZ-E series MMZ1005-E Type

■ ELECTRICAL CHARACTERISTICS

□ CHARACTERISTICS SPECIFICATION TABLE

Impedance [100MHz]		[1GHz]		DC resistance (Ω)max.	Rated current (mA)max.	Part No.
(Ω)	Tolerance	(Ω)	Tolerance			
600	$\pm 25\%$	1000	$\pm 40\%$	0.65	300	MMZ1005S601ET□□□
1000	$\pm 25\%$	1400	$\pm 40\%$	1.00	250	MMZ1005S102ET□□□
1800	$\pm 25\%$	1800	$\pm 40\%$	1.50	200	MMZ1005S182ET□□□
600	$\pm 25\%$	1400	$\pm 40\%$	0.80	300	MMZ1005A601ET□□□
1000	$\pm 25\%$	2000	$\pm 40\%$	1.20	250	MMZ1005A102ET□□□
1500	$\pm 25\%$	2300	$\pm 40\%$	1.60	230	MMZ1005A152ET□□□
1800	$\pm 25\%$	2700	$\pm 40\%$	2.10	200	MMZ1005A182ET□□□
2200	$\pm 25\%$	3000	$\pm 40\%$	2.20	150	MMZ1005A222ET□□□
120	$\pm 25\%$	1000	$\pm 40\%$	0.70	300	MMZ1005D121ET□□□
220	$\pm 25\%$	1700	$\pm 40\%$	1.00	250	MMZ1005D221ET□□□
47	$\pm 25\%$	800	$\pm 40\%$	0.70	300	MMZ1005F470ET□□□
75	$\pm 25\%$	1500	$\pm 40\%$	1.00	250	MMZ1005F750ET□□□
120	$\pm 25\%$	2300	$\pm 40\%$	1.50	200	MMZ1005F121ET□□□

○ Measurement equipment

Measurement item	Product No.	Manufacturer
Impedance	E4991A+16192A	Agilent Technologies
DC resistance	Type-7556	Yokogawa

* Equivalent measurement equipment may be used.

MMZ-E series **MMZ1005-E Type**

■ ELECTRICAL CHARACTERISTICS

□ Z VS. FREQUENCY CHARACTERISTICS (BY SERIES)

MMZ1005S-E SERIES

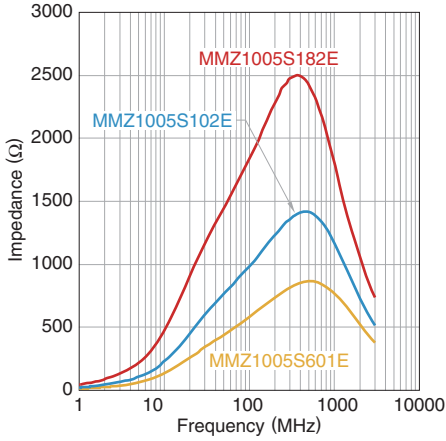

MMZ1005A-E SERIES

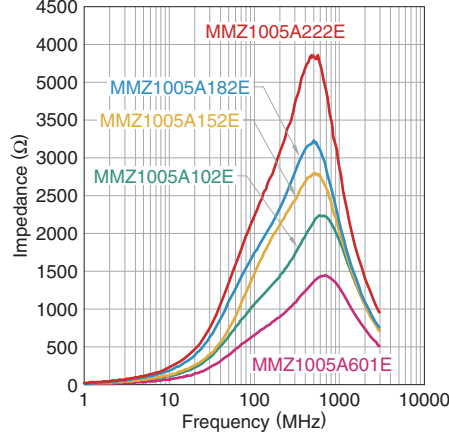

MMZ1005D-E SERIES

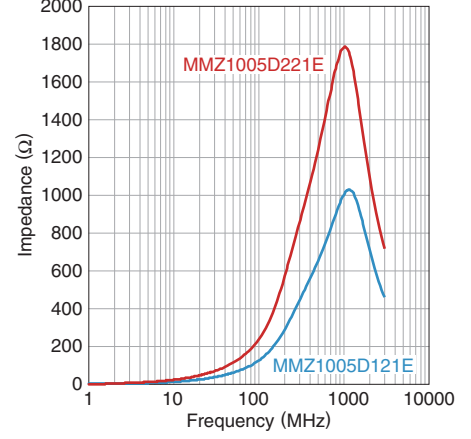

MMZ1005F-E SERIES

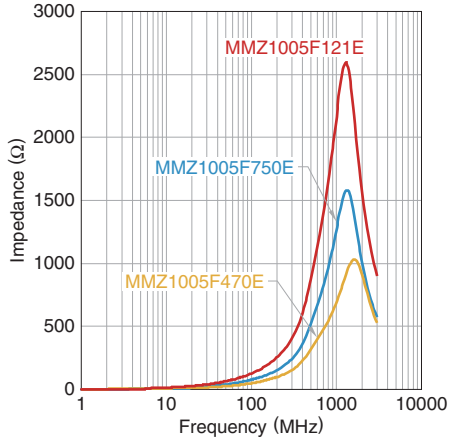

• All specifications are subject to change without notice.

MMZ-E series MMZ1005-E Type

ELECTRICAL CHARACTERISTICS

Z, X, R VS. FREQUENCY CHARACTERISTICS

MMZ1005S601E

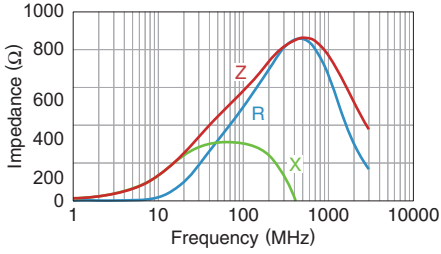

MMZ1005S102E

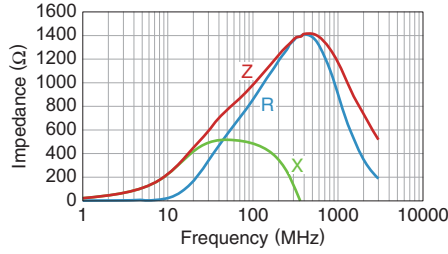

MMZ1005S182E

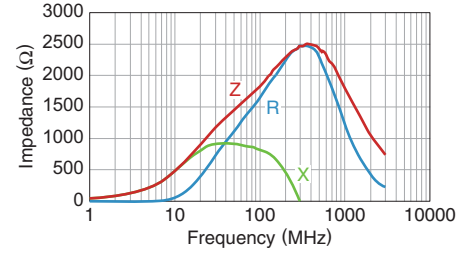

MMZ1005A601E

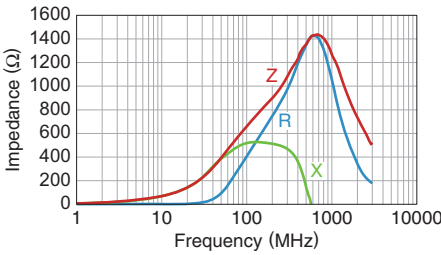

MMZ1005A102E

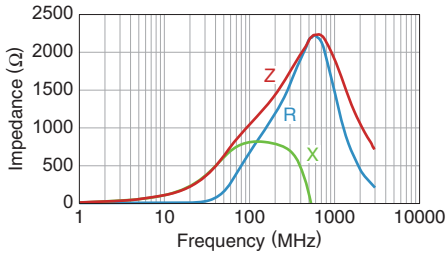

MMZ1005A152E

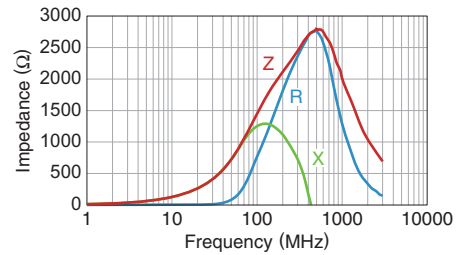

MMZ1005A182E

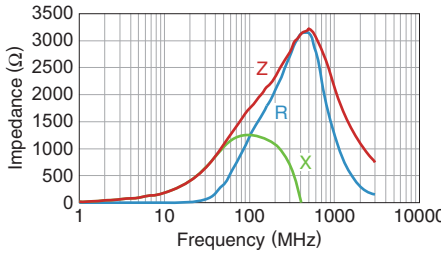

MMZ1005A222E

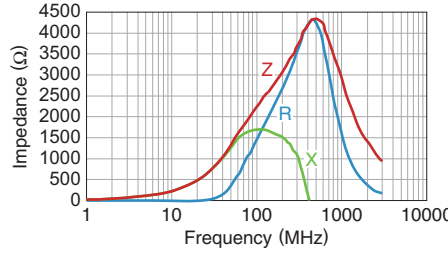

MMZ1005D121E

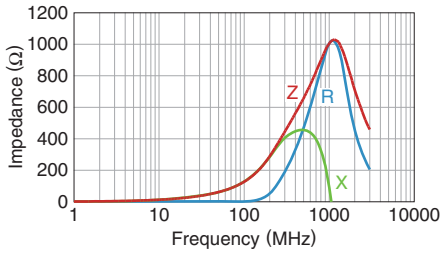

MMZ1005D221E

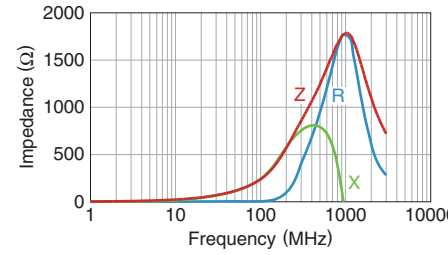

MMZ1005F470E

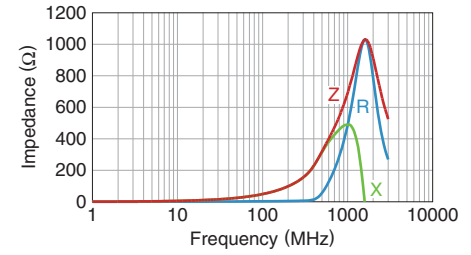

MMZ1005F750E

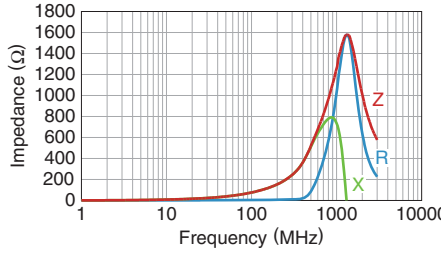

MMZ1005F121E

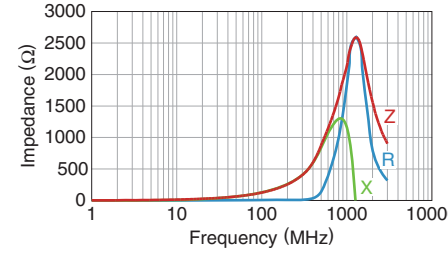

• All specifications are subject to change without notice.

MMZ-E series

Packaging style

REEL DIMENSIONS

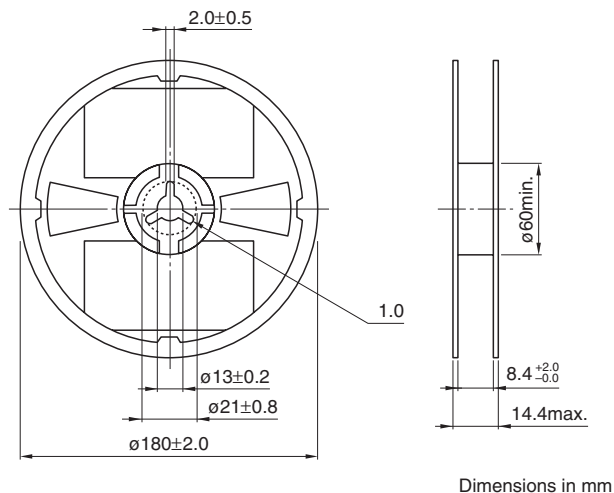

Dimensions in mm

TAPE DIMENSIONS

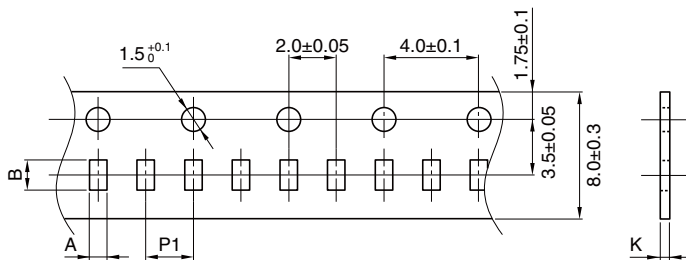

Dimensions in mm

Type	A	B	P1	K
MMZ0603-E	0.38 ± 0.05	0.68 ± 0.05	2.0 ± 0.05	0.5max.
MMZ1005-E	0.65 ± 0.1	1.15 ± 0.1	2.0 ± 0.05	0.8max.

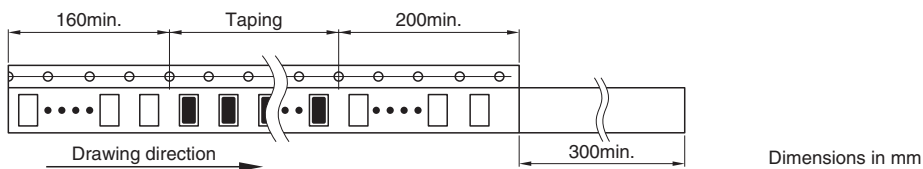

Dimensions in mm

• All specifications are subject to change without notice.