

**PLEASE CHECK WWW.MOLEX.COM FOR LATEST PART INFORMATION**

**Part Number:** [0355070400](#)  
**Status:** **Active**  
**Overview:** [Sherlock™ Connector System](#)  
**Description:** 2.00mm Pitch Sherlock™ Wire-to-Board Housing, Natural, 4 Circuits

**Documents:**

<a href="#">3D Model</a>	<a href="#">Product Specification PS-35507-003-001 (PDF)</a>
<a href="#">Drawing (PDF)</a>	<a href="#">Packaging Specification PK-35507-001 (PDF)</a>
<a href="#">Product Specification PS-35507-001-001 (PDF)</a>	<a href="#">RoHS Certificate of Compliance (PDF)</a>
<a href="#">Product Specification PS-35507-002-001 (PDF)</a>	

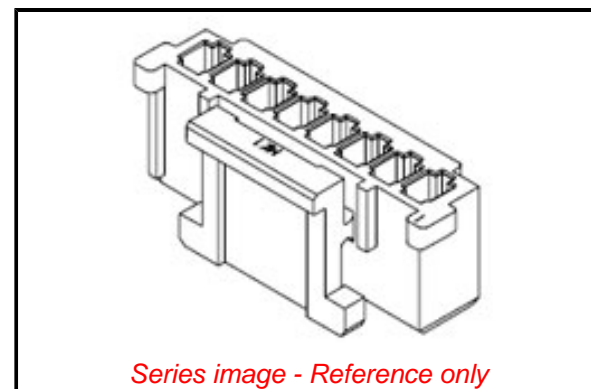

**Agency Certification**

CSA	LR19980
UL	E29179

**General**

Product Family	Crimp Housings
Series	<a href="#">35507</a>
Application	Signal, Wire-to-Board
MolexKits	Yes
Overview	<a href="#">Sherlock™ Connector System</a>
Product Name	Sherlock™
UPC	800754241861

**Physical**

Circuits (maximum)	4
Circuits Detail	4
Color - Resin	Natural
Flammability	94V-0
Gender	Female
Glow-Wire Compliant	No
Keying to Mating Part	None
Lock to Mating Part	Yes
Material - Resin	Polyester
Net Weight	0.206/g
Number of Rows	1
Packaging Type	Bag
Panel Mount	No
Pitch - Mating Interface	2.00mm
Polarized to Mating Part	Yes
Stackable	No
Temperature Range - Operating	-40°C to +105°C

**Electrical**

Current - Maximum per Contact	2.0A
-------------------------------	------

**Material Info**

**Reference - Drawing Numbers**

Packaging Specification	PK-35507-001
Product Specification	PS-35507-001-001, PS-35507-002-001, PS-35507-003-001
Sales Drawing	SD-35507-001

**EU ELV**

**Not Relevant**

**EU RoHS**

**Compliant**

**REACH SVHC**

Not Contained Per - ED/21/2016 (20 June 2016)

**Halogen-Free**

**Status**

**Not Low-Halogen**

**Need more information on product environmental compliance?**

Email [productcompliance@molex.com](mailto:productcompliance@molex.com)  
Please visit the [Contact Us](#) section for any non-product compliance questions.

China ROHS

ELV

RoHS Phthalates

Green Image

Not Relevant

Not Contained

**Search Parts in this Series**

[35507 Series](#)

**Mates With**

Sherlock™ Wire-to-Board Header [35362](#) , [35363](#)

**Use With**

2.00mm Pitch Crimp Terminal [50212](#)