

PLEASE CHECK WWW.MOLEX.COM FOR LATEST PART INFORMATION

Part Number: [0353621250](#)
Status: **Active**
Overview: [Sherlock™ Connector System](#)
Description: 2.00mm Pitch Sherlock™ Wire-to-Board Header, Vertical, with Positive Lock, 12 Circuits, with Kinked PC Tails, Natural

Documents:

[3D Model](#) [Packaging Specification PK-35362-001 \(PDF\)](#)
[Drawing \(PDF\)](#) [RoHS Certificate of Compliance \(PDF\)](#)
[Product Specification PS-35507-003-001 \(PDF\)](#)

Agency Certification

CSA LR19980
 UL E29179

General

Product Family PCB Headers
 Series [35362](#)
 Application Signal, Wire-to-Board
 Overview [Sherlock™ Connector System](#)
 Product Name Sherlock™
 UPC 822348259922

Physical

Breakaway No
 Circuits (Loaded) 12
 Circuits (maximum) 12
 Color - Resin Natural
 Durability (mating cycles max) 30
 First Mate / Last Break No
 Flammability 94V-0
 Glow-Wire Compliant No
 Guide to Mating Part No
 Keying to Mating Part None
 Lock to Mating Part Yes
 Mated Height 8.50mm
 Material - Plating Mating Tin
 Material - Plating Termination Tin
 Material - Resin Nylon
 Net Weight 685.200/mg
 Number of Rows 1
 Orientation Vertical
 PC Tail Length 3.30mm
 PCB Locator No
 PCB Retention Yes
 PCB Thickness - Recommended 1.60mm
 Packaging Type Bag
 Pitch - Mating Interface 2.00mm
 Pitch - Termination Interface 2.00mm
 Polarized to Mating Part Yes
 Polarized to PCB No
 Shrouded Partial
 Stackable No
 Surface Mount Compatible (SMC) No
 Temperature Range - Operating -40°C to +105°C
 Termination Interface: Style Through Hole

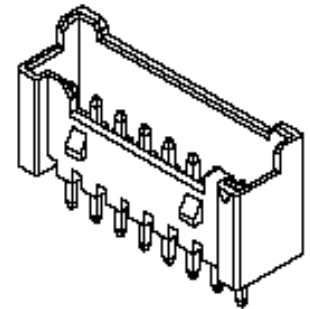

Series image - Reference only

EU ELV

Not Relevant

EU RoHS

Compliant

REACH SVHC

Not Contained Per -
 ED/21/2016 (20 June
 2016)

Halogen-Free

Status

Low-Halogen

Need more information on product environmental compliance?

Email productcompliance@molex.com
 Please visit the [Contact Us](#) section for any non-product compliance questions.

China ROHS	Green Image
ELV	Not Relevant
RoHS Phthalates	Not Contained

Search Parts in this Series

[35362](#) Series

Mates With

[35507](#) Sherlock™ Wire-to-Board Housing

Use With

[50212-8000](#) Terminal

Electrical

Current - Maximum per Contact	2.0A
Voltage - Maximum	125V

Material Info**Reference - Drawing Numbers**

Packaging Specification	PK-35362-001
Product Specification	PS-35507-003-001
Sales Drawing	SD-35362-002

This document was generated on 12/27/2016

PLEASE CHECK WWW.MOLEX.COM FOR LATEST PART INFORMATION