

## Description

The AZ2117 is a low dropout three-terminal regulator.

The AZ2117 has been optimized for low voltage where transient response and minimum input voltage are critical. It provides current limit and thermal shutdown. Its circuit includes a trimmed bandgap reference to assure output voltage accuracy to be within  $\pm 1\%$ . On-chip thermal shutdown provides protection against a combination of high current and ambient temperature that would create excessive junction temperature.

The AZ2117 is available in ADJ output voltage version. It is available in an adjustable version which can set the output voltage with two external resistors.

The AZ2117 is available in the industry-standard SOT223 Series power packages.

## Features

- Current Limit: 1.35A (Typ)
- Output Noise from 10Hz to 10kHz: 0.003% of  $V_{OUT}$
- PSRR at  $I_{OUT} = 300\text{mA}$  and  $f = 120\text{Hz}$ : 60dB
- Output Voltage Accuracy:  $\pm 1\%$
- On-chip Thermal Shutdown
- Maximum Quiescent Current:  $I_{QMAX} = 1\text{mA}$
- Compatible with Low ESR Ceramic Capacitor
- Operation Junction Temperature:  $-40^{\circ}\text{C}$  to  $+125^{\circ}\text{C}$
- **Totally Lead-Free & Fully RoHS Compliant (Notes 1 & 2)**
- **Halogen and Antimony Free. "Green" Device (Note 3)**

- Notes:
1. No purposely added lead. Fully EU Directive 2002/95/EC (RoHS) & 2011/65/EU (RoHS 2) compliant.
  2. See [http://www.diodes.com/quality/lead\\_free.html](http://www.diodes.com/quality/lead_free.html) for more information about Diodes Incorporated's definitions of Halogen- and Antimony-free, "Green" and Lead-free.
  3. Halogen- and Antimony-free "Green" products are defined as those which contain <900ppm bromine, <900ppm chlorine (<1500ppm total Br + Cl) and <1000ppm antimony compounds.

## Pin Assignments

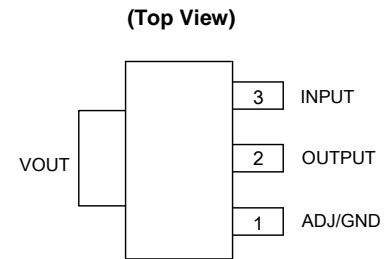

**SOT223**

## Applications

- USB Device
- Add-on Card
- DVD Player
- PC Motherboard

## Typical Applications Circuit (Note 4)

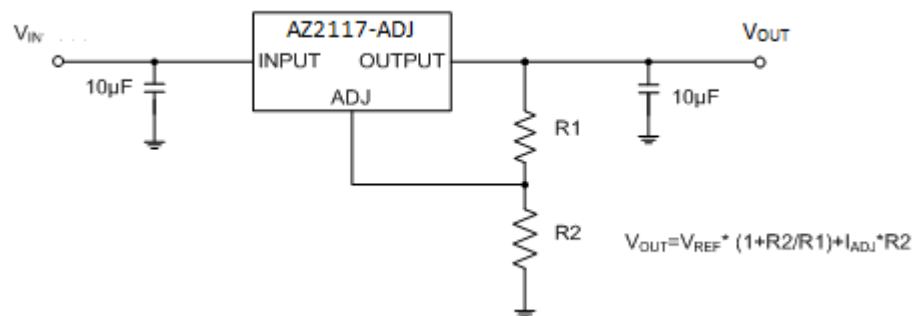

- Note 4: The AZ2117 is compatible with low ESR ceramic capacitor. The ESR of the output capacitors must be less than  $20\Omega$ . A minimum of  $1\mu\text{F}$  output capacitor is required.

**Functional Block Diagram**

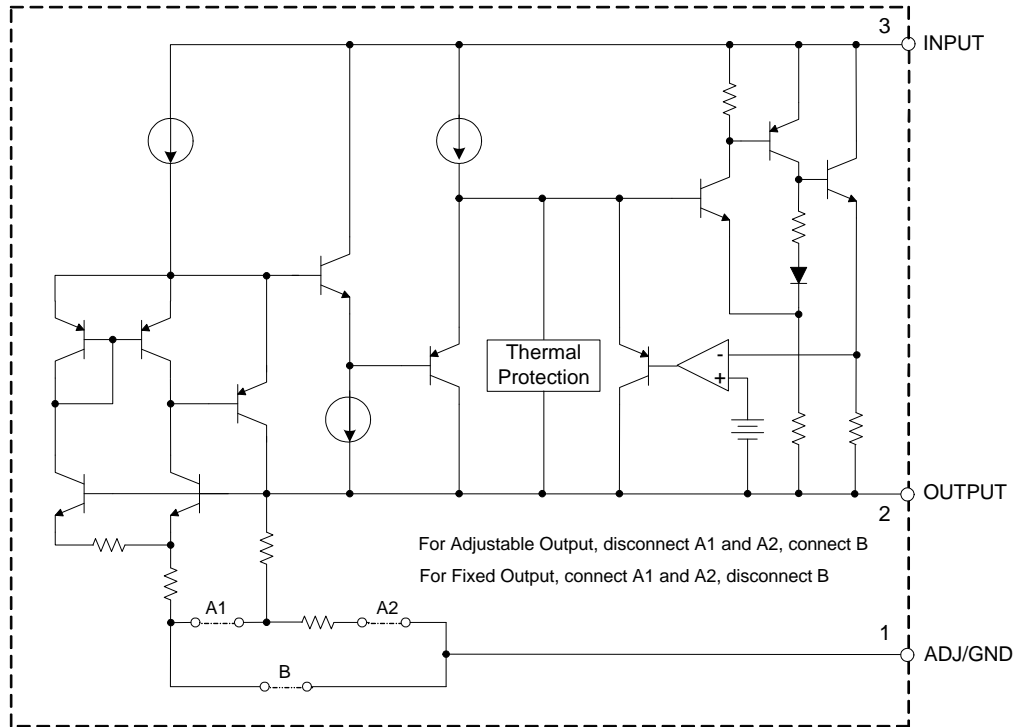

**Absolute Maximum Ratings** (Note 5)

Symbol	Parameter	Rating		Unit
$V_{IN}$	Input Voltage	18		V
$T_J$	Operating Junction Temperature Range	+150		°C
$T_{STG}$	Storage Temperature Range	-65 to +150		°C
$\theta_{JA}$	Thermal Resistance (Without Heatsink)	SOT223	125	°C/W
$\theta_{JA}$	Thermal Resistance (With Heatsink) (Note 6)	SOT223	100	°C/W
$T_{LEAD}$	Lead Temperature (Soldering, 10sec)	+260		°C

Notes: 5. Stresses greater than those listed under "Absolute Maximum Ratings" may cause permanent damage to the device. These are stress ratings only, and functional operation of the device at these or any other conditions beyond those indicated under "Recommended Operating Conditions" is not implied. Exposure to "Absolute Maximum Ratings" for extended periods may affect device reliability.

6. Chip is soldered to 100mm<sup>2</sup>(10mm\*10mm) copper (top side solder mask) on 2oz.2 layers FR-4 PCB with 8\*0.5mm vias.

**Recommended Operating Conditions**

Symbol	Parameter	Min	Max	Unit
$V_{IN}$	Input Voltage	—	15	V
$T_J$	Operating Junction Temperature Range	-40	+125	°C

## Electrical Characteristics

(Operating Conditions:  $V_{IN} \leq 10V$ ,  $I_{OUT} = 10mA$ ,  $T_J = +25^\circ C$ , unless otherwise specified. ( $P \leq$  maximum power dissipation). Limits appearing in **Boldface** type apply over the entire junction temperature range for operation,  $-40^\circ C$  to  $+125^\circ C$ .)

Symbol	Parameter	Conditions	Min	Typ	Max	Unit	
$V_{REF}$	Reference Voltage	$V_{OUT}+1.75V \leq V_{IN} \leq 12V$ , $I_{OUT} = 10mA$	1.238	1.250	1.262	V	
			<b>98%*<math>V_{OUT}</math></b>	$V_{OUT}$	<b>102%*<math>V_{OUT}</math></b>	V	
$V_{DROP}$	Dropout Voltage	$I_{OUT} = 1A$	—	1.3	1.5	V	
$I_{LIMIT}$ (Note 7)	Maximum Output Current	$1.75V \leq V_{IN}-V_{OUT}$	1.25	1.35	1.5	A	
$V_{RLOAD}$	Load Regulation	$V_{IN} = V_{OUT}+1.75V$ $1mA \leq I_{OUT} \leq 1A$	—	0.2	0.6	%/A	
$V_{RLINE}$	Line Regulation	$1.75V \leq V_{IN}-V_{OUT} \leq 10V$ , $I_{OUT} = 30mA$	—	0.001	0.04	%/V	
$I_Q$	Quiescent Current	$I_{OUT} = 0$	—	0.35	1	mA	
—	Minimum Load Current	For ADJ Version, $1.75V \leq V_{IN}-V_{OUT} \leq 10V$	—	0.3	1	mA	
$I_{ADJ}$	Adjustable Pin Current	—	—	7	10	$\mu A$	
—	Adjustable Pin Current Change	$1.75V \leq V_{IN}-V_{OUT} \leq 10V$	—	0.3	2	$\mu A$	
PSRR	Power Supply Rejection Ratio	Ripple 1.0 Vp-p $V_{IN} = V_{OUT}+2V$ , $I_{OUT} = 100mA$	f = 120Hz	—	60	—	dB
			f = 1kHz	—	60	—	
$\frac{\Delta V_{OUT}}{V_{OUT}} / \Delta T$	Output Voltage Temperature Coefficient	$I_{OUT} = 30mA$	—	$\pm 100$	—	ppm/ $^\circ C$	
$V_{NOISE}$	RMS Output Noise	$10Hz \leq f \leq 100kHz$ , No Load	—	0.003	—	%	
$T_{OTSD}$	Thermal Shutdown Temperature	—	—	+170	—	$^\circ C$	
$T_{HYOTSD}$	Thermal Shutdown Hysteresis	—	—	+20	—	$^\circ C$	
$\theta_{JC}$	Thermal Resistance (Junction to Case)	SOT223	—	40	—	$^\circ C/W$	

Note 7: Make the  $V_{OUT}$  down to about 98% of the test values,  $I_{OUT}$  value is set to  $I_{LIMIT}$  at this time.

**Performance Characteristics**

**Line Regulation vs. Temperature**

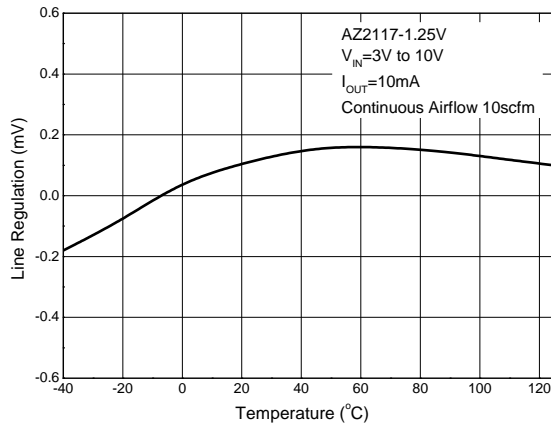

**Load Regulation vs. Temperature**

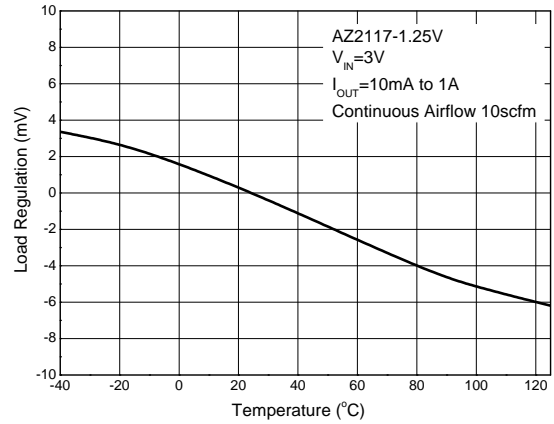

**Reference Voltage vs. Temperature**

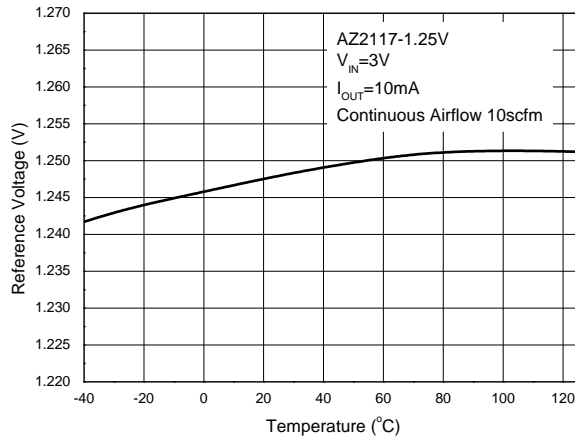

**Current Limit vs. Temperature**

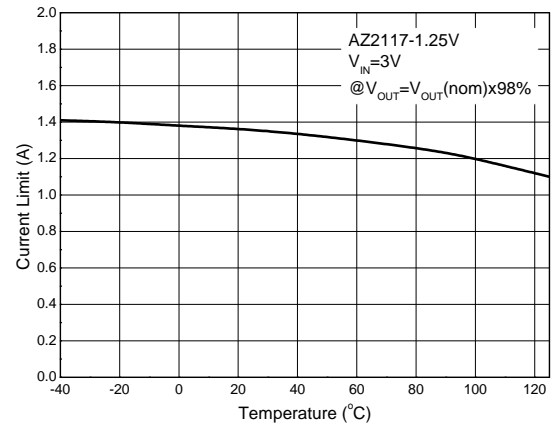

**Minimum Load Current vs. Temperature**

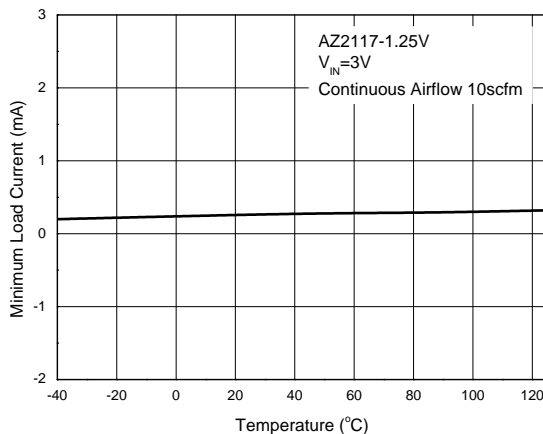

**Adjust Pin Current vs. Temperature**

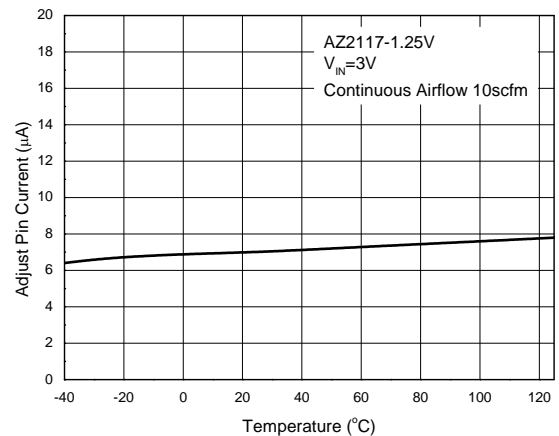

NEW PRODUCT

**Performance Characteristics (Cont.)**

**Dropout Voltage vs. Output Current**

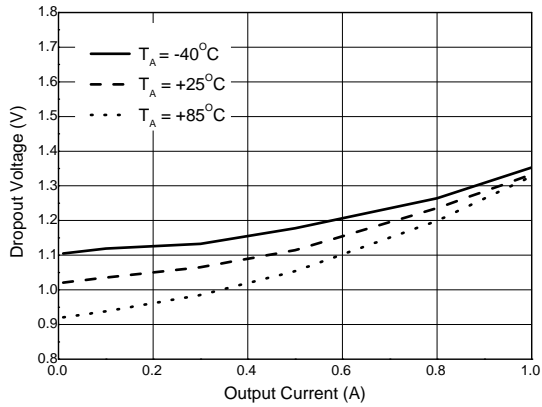

**Dropout Voltage vs. Temperature**

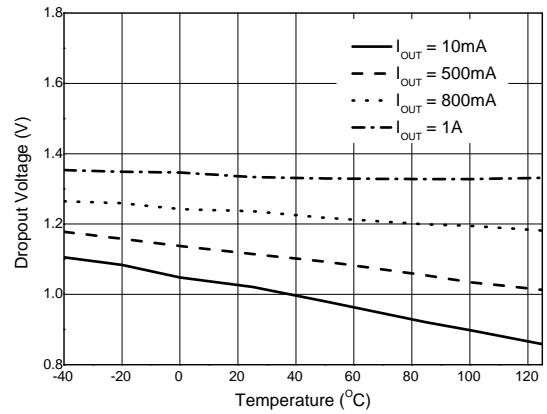

**PSRR vs. Frequency**

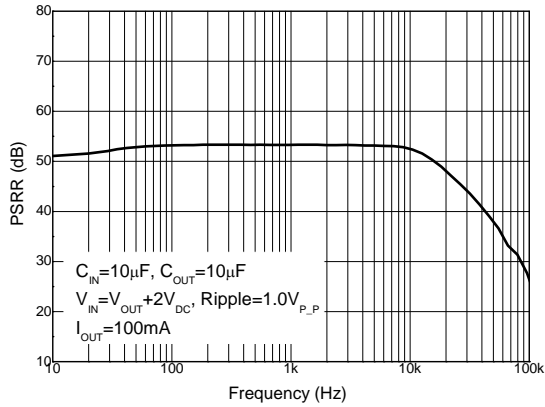

**Load Transient Response**

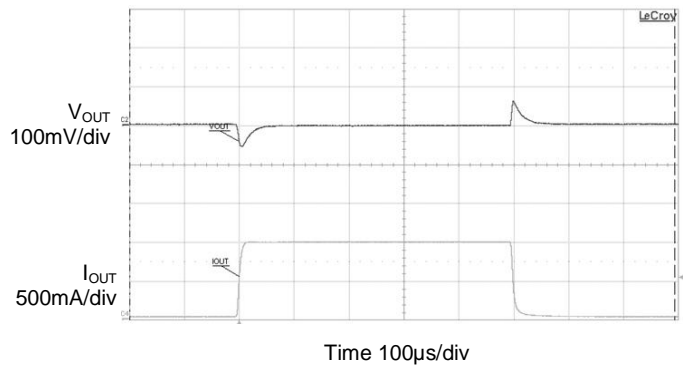

**Power Dissipation vs. Temperature**

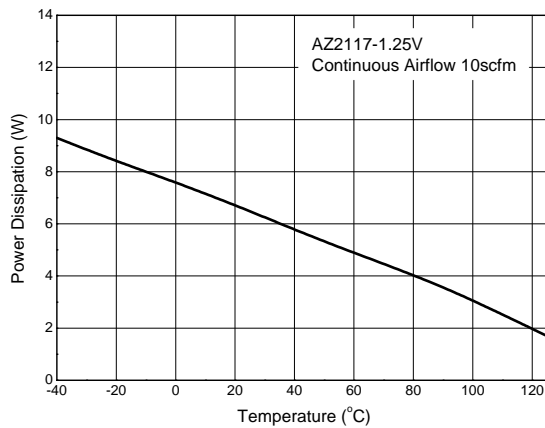

NEW PRODUCT

**Ordering Information**

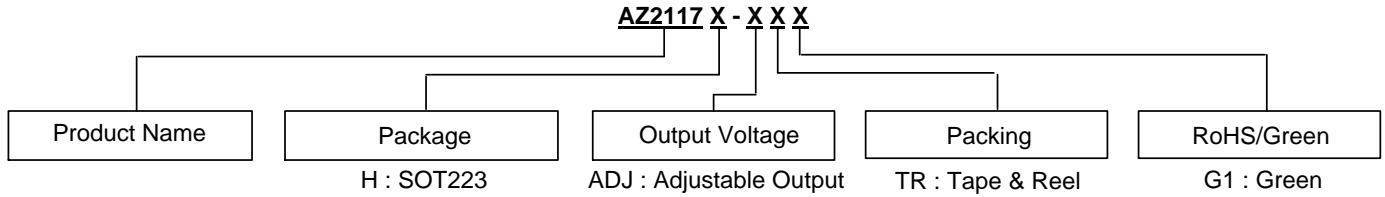

Package	Temperature Range	Part Number	Marking ID	Packing
SOT223	-40°C to +125°C	AZ2117H-ADJTRG1	GH15P	4000/Tape & Reel

**Marking Information**

(1) SOT223

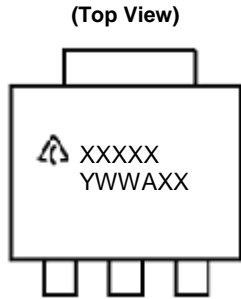

First Line: Logo and Marking ID  
(See Ordering Information)  
Second Line: Date Code  
Y: Year  
WW: Work Week of Molding  
A: Assembly House Code  
XX: 7<sup>th</sup> and 8<sup>th</sup> Digits of Batch Number

NEW PRODUCT

**Package Outline Dimensions** (All dimensions in mm (inch).)

(1) Package Type: SOT223

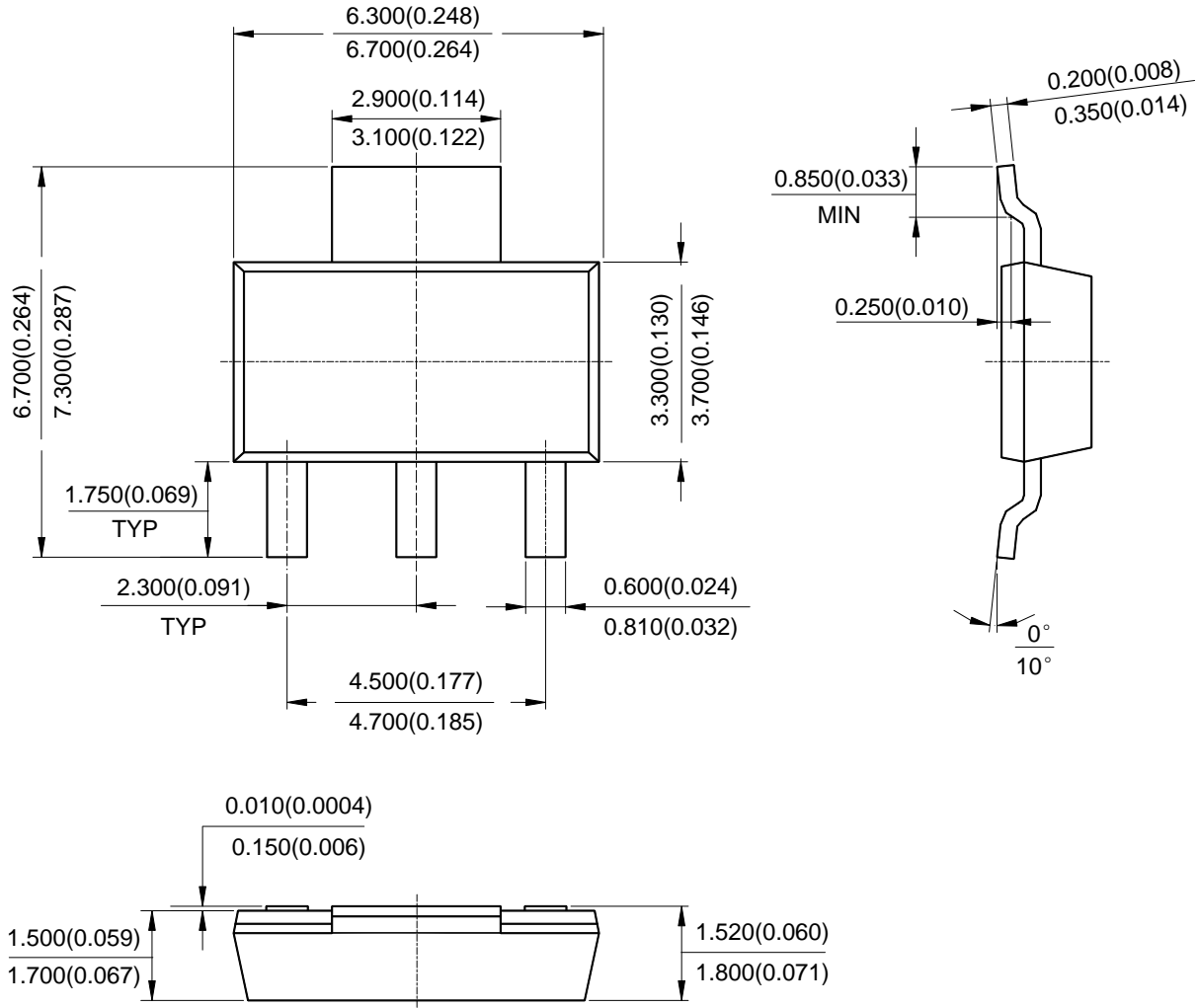

NEW PRODUCT

**Suggested Pad Layout**

(1) Package Type: SOT223

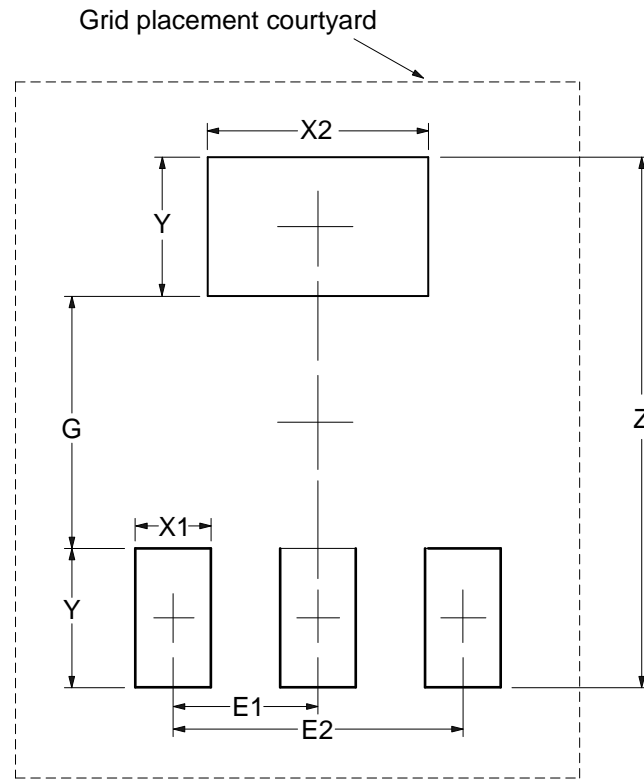

Dimensions	Z (mm)/(inch)	G (mm)/(inch)	X1 (mm)/(inch)	X2 (mm)/(inch)	Y (mm)/(inch)	E1 (mm)/(inch)	E2 (mm)/(inch)
Value	8.400/0.331	4.000/0.157	1.200/0.047	3.500/0.138	2.200/0.087	2.300/0.091	4.600/0.181



**IMPORTANT NOTICE**

DIODES INCORPORATED MAKES NO WARRANTY OF ANY KIND, EXPRESS OR IMPLIED, WITH REGARDS TO THIS DOCUMENT, INCLUDING, BUT NOT LIMITED TO, THE IMPLIED WARRANTIES OF MERCHANTABILITY AND FITNESS FOR A PARTICULAR PURPOSE (AND THEIR EQUIVALENTS UNDER THE LAWS OF ANY JURISDICTION).

Diodes Incorporated and its subsidiaries reserve the right to make modifications, enhancements, improvements, corrections or other changes without further notice to this document and any product described herein. Diodes Incorporated does not assume any liability arising out of the application or use of this document or any product described herein; neither does Diodes Incorporated convey any license under its patent or trademark rights, nor the rights of others. Any Customer or user of this document or products described herein in such applications shall assume all risks of such use and will agree to hold Diodes Incorporated and all the companies whose products are represented on Diodes Incorporated website, harmless against all damages.

Diodes Incorporated does not warrant or accept any liability whatsoever in respect of any products purchased through unauthorized sales channel. Should Customers purchase or use Diodes Incorporated products for any unintended or unauthorized application, Customers shall indemnify and hold Diodes Incorporated and its representatives harmless against all claims, damages, expenses, and attorney fees arising out of, directly or indirectly, any claim of personal injury or death associated with such unintended or unauthorized application.

Products described herein may be covered by one or more United States, international or foreign patents pending. Product names and markings noted herein may also be covered by one or more United States, international or foreign trademarks.

This document is written in English but may be translated into multiple languages for reference. Only the English version of this document is the final and determinative format released by Diodes Incorporated.

**LIFE SUPPORT**

Diodes Incorporated products are specifically not authorized for use as critical components in life support devices or systems without the express written approval of the Chief Executive Officer of Diodes Incorporated. As used herein:

A. Life support devices or systems are devices or systems which:

1. are intended to implant into the body, or
2. support or sustain life and whose failure to perform when properly used in accordance with instructions for use provided in the labeling can be reasonably expected to result in significant injury to the user.

B. A critical component is any component in a life support device or system whose failure to perform can be reasonably expected to cause the failure of the life support device or to affect its safety or effectiveness.

Customers represent that they have all necessary expertise in the safety and regulatory ramifications of their life support devices or systems, and acknowledge and agree that they are solely responsible for all legal, regulatory and safety-related requirements concerning their products and any use of Diodes Incorporated products in such safety-critical, life support devices or systems, notwithstanding any devices- or systems-related information or support that may be provided by Diodes Incorporated. Further, Customers must fully indemnify Diodes Incorporated and its representatives against any damages arising out of the use of Diodes Incorporated products in such safety-critical, life support devices or systems.

Copyright © 2017, Diodes Incorporated

[www.diodes.com](http://www.diodes.com)

# Mouser Electronics

Authorized Distributor

Click to View Pricing, Inventory, Delivery & Lifecycle Information:

[Diodes Incorporated:](#)

[AZ2117H-ADJTRG1](#)