

OPT-24DC/ 24DC/ 2 - Miniature solid-state relay



2966595

<https://www.phoenixcontact.com/us/products/2966595>

Please be informed that the data shown in this PDF document is generated from our Online Catalog. Please find the complete data in the user documentation. Our General Terms of Use for Downloads are valid.



Plug-in miniature solid-state relay, power solid-state relay, 1 N/O contact, input: 24 V DC, output: 3 ... 33 V DC/3 A

Your advantages

- Vibration and shock resistant
- RT III-proof (wash-proof)
- Wear-free and durable
- Can be soldered on PCB
- Switching capacity of up to 24 V DC/3 A

Commercial Data

Item number	2966595
Packing unit	1 pc
Minimum order quantity	10 pc
Sales Key	C460
Product Key	CK61F2
Catalog Page	Page 286 (C-5-2019)
GTIN	4017918130947
Weight per Piece (including packing)	5.26 g
Weight per Piece (excluding packing)	5.2 g
Customs tariff number	85364190
Country of origin	HU

OPT-24DC/ 24DC/ 2 - Miniature solid-state relay



2966595

<https://www.phoenixcontact.com/us/products/2966595>

Technical Data

Product properties

Product type	Single solid-state relay
Set comprises	2905293 RIF-0-OPT-24DC/24DC/2
	2905657 RIF-0-OSC-24DC/24DC/2
Operating mode	100% operating factor

Insulation characteristics

Insulation	Basic insulation
------------	------------------

Insulation characteristics: Standards/regulations

Insulation	Basic insulation
Overvoltage category	III
Pollution degree	2

Electrical properties

Maximum power dissipation for nominal condition	0.17 W
Test voltage (Input/output)	2.5 kV (50 Hz, 1 min., input/output)

Input data

Nominal input voltage U_N	24 V DC
Input voltage range in reference to U_N	0.8 ... 1.2
Input voltage range	19.2 V DC ... 28.8 V DC
Switching threshold "0" signal, voltage	≤ 10 V
Switching threshold "1" signal voltage	≥ 16 V
Typical input current at U_N	7 mA
Typical response time	20 μ s (at U_N)
Typical turn-off time	300 μ s (at U_N)
Transmission frequency	300 Hz

Output data

Contact type	1 N/O contact
Design of digital output	electronic
Output voltage range	3 V DC ... 33 V DC
Limiting continuous current	3 A (see derating curve)
Maximum inrush current	15 A (10 ms)
Voltage drop at max. limiting continuous current	≤ 150 mV
Output circuit	2-conductor, floating
Protective circuit	Reverse polarity protection
	Surge protection

Dimensions

OPT-24DC/ 24DC/ 2 - Miniature solid-state relay

2966595

<https://www.phoenixcontact.com/us/products/2966595>

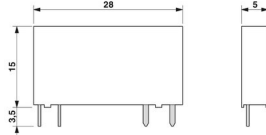
Dimensional drawing	
Width	5 mm
Height	28 mm
Depth	15 mm

Environmental and real-life conditions

Ambient conditions

Degree of protection	RT III
Ambient temperature (operation)	-25 °C ... 60 °C
Ambient temperature (storage/transport)	-25 °C ... 70 °C

Approval data

Corrosive gas test

Identification	ISA-S71.04. G3 Harsh Group
	EN 60068-2-60

Standards and regulations

Standards/regulations

Standards/regulations	IEC 60664
	EN 50178

Mounting

Assembly instructions	in rows with zero spacing
Mounting position	any

OPT-24DC/ 24DC/ 2 - Miniature solid-state relay



2966595

<https://www.phoenixcontact.com/us/products/2966595>

Drawings

Drilling plan/solder pad geometry

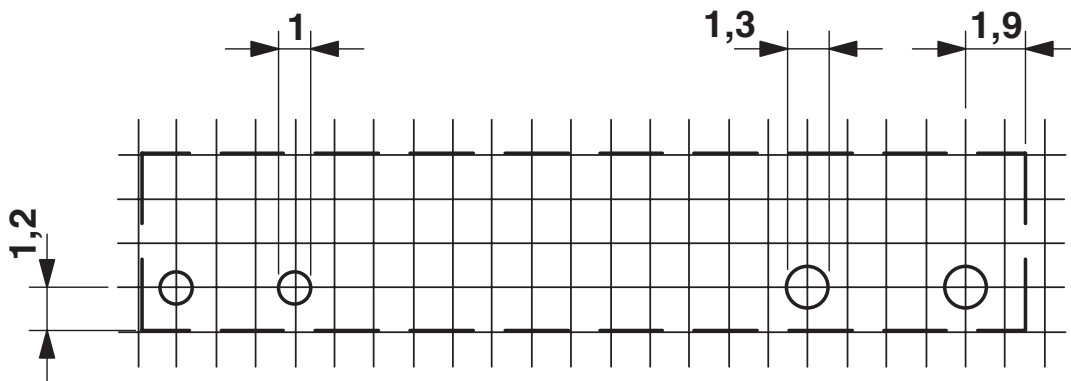

a = pitch division 1.25 mm and 1.27 mm

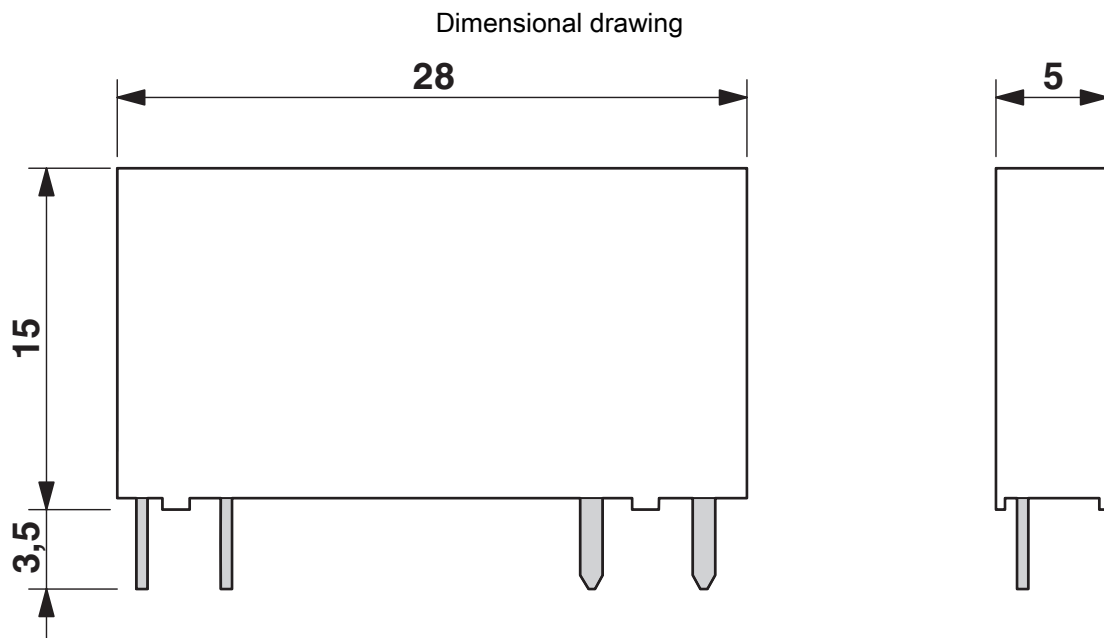

OPT-24DC/ 24DC/ 2 - Miniature solid-state relay

2966595

<https://www.phoenixcontact.com/us/products/2966595>

Diagram

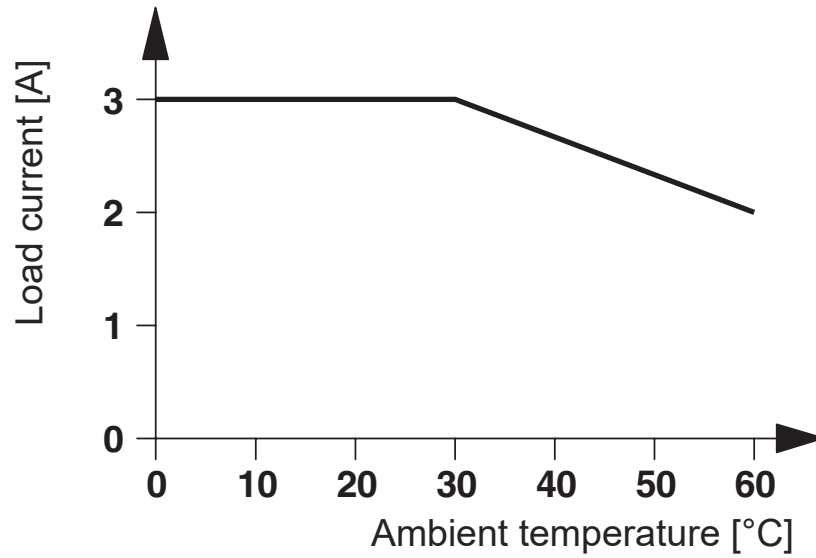

Circuit diagram

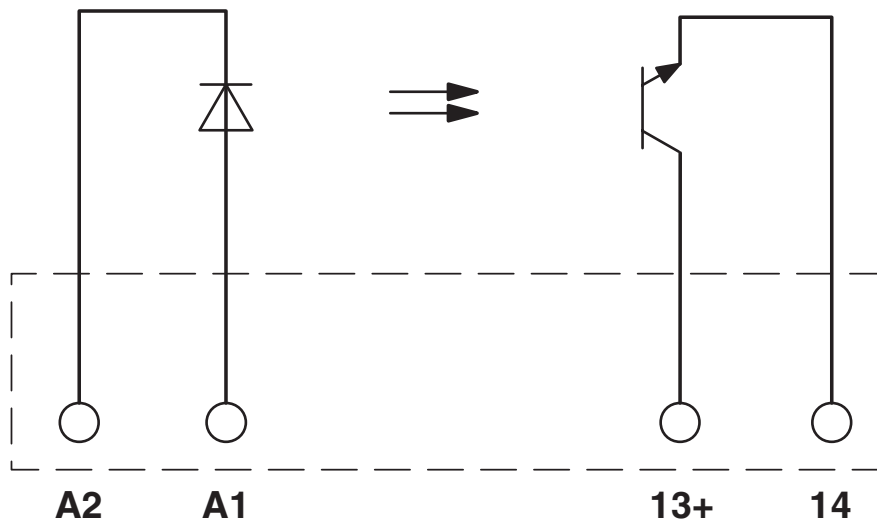

OPT-24DC/ 24DC/ 2 - Miniature solid-state relay



2966595

<https://www.phoenixcontact.com/us/products/2966595>

Approvals



cUL Recognized
Approval ID: FILE E 195083



UL Recognized
Approval ID: FILE E 195083



EAC
Approval ID: TR_TS_D_00573_c



UL Recognized
Approval ID: FILE E 195083



PRS
Approval ID: TE/2109/880590/16



cUL Recognized
Approval ID: FILE E 195083



GL
Approval ID: 46016-03 HH

Nominal Voltage U_N

Nominal Current I_N

Cross Section AWG

Cross Section mm^2

-

-

OPT-24DC/ 24DC/ 2 - Miniature solid-state relay



2966595

<https://www.phoenixcontact.com/us/products/2966595>

Classifications

ECLASS

ECLASS-9.0	27371604
ECLASS-10.0.1	27371604
ECLASS-11.0	27371604

ETIM

ETIM 8.0	EC001504
----------	----------

UNSPSC

UNSPSC 21.0	39122300
-------------	----------

OPT-24DC/ 24DC/ 2 - Miniature solid-state relay



2966595

<https://www.phoenixcontact.com/us/products/2966595>

Environmental Product Compliance

China RoHS	Environmentally friendly use period: unlimited = EFUP-e
	No hazardous substances above threshold values

OPT-24DC/ 24DC/ 2 - Miniature solid-state relay



2966595

<https://www.phoenixcontact.com/us/products/2966595>

Accessories

PLC-BPT- 24DC/21 - Relay base

2900445

<https://www.phoenixcontact.com/us/products/2900445>



6.2 mm PLC basic terminal block with Push-in connection, without relay or solid-state relay, for mounting on DIN rail NS 35/7,5, 1 changeover contact, input voltage 24 V DC

PLC-BSC- 24DC/21 - Relay base

2966016

<https://www.phoenixcontact.com/us/products/2966016>



6.2 mm PLC basic terminal block with screw connection, without relay or solid-state relay, for mounting on DIN rail NS 35/7,5, 1 changeover contact, input voltage 24 V DC

OPT-24DC/ 24DC/ 2 - Miniature solid-state relay



2966595

<https://www.phoenixcontact.com/us/products/2966595>

PLC-BPIT- 48DC/21 - Relay base

2900447

<https://www.phoenixcontact.com/us/products/2900447>



6.2 mm PLC basic terminal block with Push-in connection, without relay or solid-state relay, for mounting on DIN rail NS 35/7,5, 1 changeover contact, input voltage 48 V DC

PLC-BSC- 48DC/21 - Relay base

2966090

<https://www.phoenixcontact.com/us/products/2966090>



6.2 mm PLC basic terminal block with screw connection, without relay or solid-state relay, for mounting on DIN rail NS 35/7,5, 1 changeover contact, input voltage 48 V DC

OPT-24DC/ 24DC/ 2 - Miniature solid-state relay



2966595

<https://www.phoenixcontact.com/us/products/2966595>

PLC-BPT- 24DC/ 1/SEN - Relay base

2900262

<https://www.phoenixcontact.com/us/products/2900262>



6.2 mm PLC basic terminal block for input functions with push-in connection, without relay or solid-state relay, for mounting on DIN rail NS 35/7,5, with sensor supply voltage distribution (BB), 1 N/O contact, input voltage 24 V DC

PLC-BSC- 24DC/ 1/SEN - Relay base

2966061

<https://www.phoenixcontact.com/us/products/2966061>



6.2 mm PLC basic terminal block for input functions with screw connection, without relay or solid-state relay, for mounting on DIN rail NS 35/7,5, with sensor supply voltage distribution (BB), 1 N/O contact, input voltage 24 V DC

OPT-24DC/ 24DC/ 2 - Miniature solid-state relay



2966595

<https://www.phoenixcontact.com/us/products/2966595>

PLC-BPT- 24DC/ 1/ACT - Relay base

2900449

<https://www.phoenixcontact.com/us/products/2900449>



6.2 mm PLC basic terminal block for output functions with push-in connection, without relay or solid-state relay, for mounting on DIN rail NS 35/7,5, with load return line connection (BB), 1 N/O contact, input voltage 24 V DC

PLC-BSC- 24DC/ 1/ACT - Relay base

2966058

<https://www.phoenixcontact.com/us/products/2966058>



6.2 mm PLC basic terminal block for output functions with screw connection, without relay or solid-state relay, for mounting on DIN rail NS 35/7,5, with load return line connection (BB), 1 N/O contact, input voltage 24 V DC

OPT-24DC/ 24DC/ 2 - Miniature solid-state relay

2966595

<https://www.phoenixcontact.com/us/products/2966595>

PLC-BPT- 24UC/ 1/ACT - Relay base

2900450

<https://www.phoenixcontact.com/us/products/2900450>



6.2 mm PLC basic terminal block for output functions with push-in connection, without relay or solid-state relay, for mounting on DIN rail NS 35/7,5, with load return line connection (BB), 1 N/O contact, input voltage 24 V AC/DC

PLC-BSC- 24UC/ 1/ACT - Relay base

2982799

<https://www.phoenixcontact.com/us/products/2982799>



6.2 mm PLC basic terminal block for output functions with screw connection, without relay or solid-state relay, for mounting on DIN rail NS 35/7,5, with load return line connection (BB), 1 N/O contact, input voltage 24 V AC/DC

OPT-24DC/ 24DC/ 2 - Miniature solid-state relay



2966595

<https://www.phoenixcontact.com/us/products/2966595>

PLC-BSC- 24DC/21/SO46 - Relay base

2980458

<https://www.phoenixcontact.com/us/products/2980458>



6.2 mm PLC basic terminal block with protection against interference currents/voltages on the control side, with screw connection, without relay or solid-state relay, for mounting on DIN rail NS 35/7,5, with increased input current consumption, 1 changeover contact, input voltage 24 V DC

RIF-0-BPT/1 - Relay base

2901873

<https://www.phoenixcontact.com/us/products/2901873>

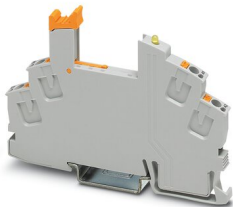

RIF-0... relay base, for miniature power relay with 1 N/O contact or solid-state relays of the same design, push-in connection, for mounting on NS 35/7,5

OPT-24DC/ 24DC/ 2 - Miniature solid-state relay



2966595

<https://www.phoenixcontact.com/us/products/2966595>

RIF-0-BSC/ 1 - Relay base

2901872

<https://www.phoenixcontact.com/us/products/2901872>

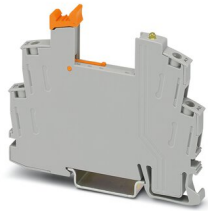

RIF-0... relay base, for miniature power relay with 1 N/O contact or identical solid-state relays, screw connection, for mounting on NS 35/7,5

Phoenix Contact 2023 © - all rights reserved

<https://www.phoenixcontact.com>

Phoenix Contact USA
586 Fulling Mill Road
Middletown, PA 17057, United States
(+717) 944-1300
info@phoenixcon.com