

P6SMB Series

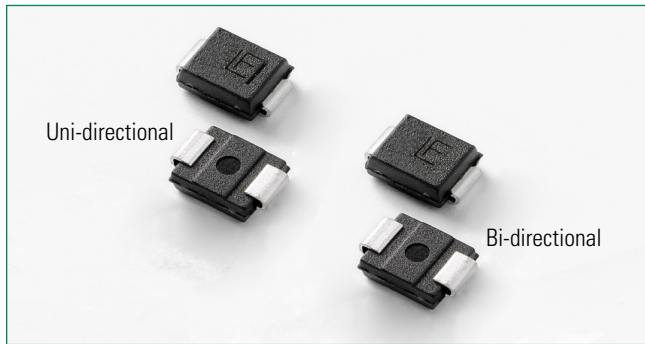

Agency Approvals

Agency	Agency File Number
	E230531

Maximum Ratings and Thermal Characteristics
(T_A = 25°C unless otherwise noted)

Parameter	Symbol	Value	Unit
Peak Pulse Power Dissipation ^(Fig.2) by 10/1000us Test Waveform ^(Fig.4) (Note 1),(Note 2)-Single Die Parts	P _{PPM}	600	W
Peak Pulse Power Dissipation ^(Fig.2) by 10/1000us Test Waveform ^(Fig.4) (Note 1, Note 2)-Stacked Die Parts (Note 5)	P _{PPM}	800	W
Power Dissipation on Infinite Heat Sink at T _L =50°C	P _D	5.0	W
Peak Forward Surge Current, 8.3ms Single Half Sine Wave (Note 3)	I _{FSM}	100	A
Maximum Instantaneous Forward Voltage at 50A for Unidirectional Only (Note 4)	V _F	3.5/5.0	V
Operating Temperature Range	T _J	-65 to 150	°C
Storage Temperature Range	T _{STG}	-65 to 175	°C
Typical Thermal Resistance Junction to Lead	R _{θJL}	20	°C/W
Typical Thermal Resistance Junction to Ambient	R _{θJA}	100	°C/W

- Notes:**
1. Non-repetitive current pulse, per Fig. 4 and derated above T_J (initial) = 25°C per Fig. 3.
 2. Mounted on copper pad area of 0.2x0.2" (5.0 x 5.0mm) to each terminal.
 3. Measured on 8.3ms single half sine wave or equivalent square wave for unidirectional device only, duty cycle=4 per minute maximum.
 4. V_F < 3.5V for single die parts and V_F < 5.0V for stacked-die parts.
 5. For stacked die component details, please refer to part numbers labeled by * in Electrical Characteristics.

Description

The P6SMB series is designed specifically to protect sensitive electronic equipment from voltage transients induced by lightning and other transient voltage events.

Features

- 600W peak pulse power capability at 10/1000µs waveform, repetition rate (duty cycles):0.01 %
- Excellent clamping capability
- Low incremental surge resistance
- Typical I_R less than 1µA when V_{BR} min > 12V
- Optimized surface mount footprint for minimal PCB space impact
- Low profile package
- Typical failure mode due to exceeding maximum ratings is a short circuit condition
- Whisker test conducted based on Table 4a and 4c of JEDEC JESD201A
- IEC 61000-4-2 ESD 30kV(Air), 30kV (Contact)
- EFT protection of data lines in accordance with IEC 61000-4-4
- Built-in strain relief
- Fast response time: typically less than 1.0ps from 0V to V_{BR} min
- High temperature to reflow soldering guaranteed: 260°C/30sec
- V_{BR} @ T_J = V_{BR} @ 25°C x (1 + α T (T_J - 25)) (α T: Temperature Coefficient, typical value is 0.1%)
- UL Recognized compound meeting flammability classification V-0
- Meet MSL level1, per J-STD-020, LF maximum peak of 260°C
- Matte tin lead-free plated
- Halogen free and RoHS compliant
- Pb-free E3 means 2ND level interconnect is Pb-free and the terminal finish material is tin(Sn) (IPC/ JEDEC J-STD-609A.01)
- UL Recognized to ANSI/UL 497B: Protectors for Data Communications and Fire-Alarm Circuits.

Applications

TVS devices are ideal for the protection of I/O Interfaces, V_{CC} bus and other vulnerable circuits used in Telecom, Computer, Industrial and Consumer electronic applications.

Functional Diagram

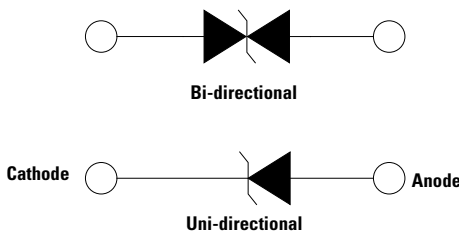

Additional Information



Electrical Characteristics (T_A=25°C unless otherwise noted)

Part Number (Uni)	Part Number (Bi)	Marking		Reverse Stand off Voltage V _R (Volts)	Breakdown Voltage V _{BR} (Volts) @ I _T		Test Current I _T (mA)	Maximum Clamping Voltage V _C @ I _{pp} (V)	Maximum Peak Pulse Current I _{pp} (A)	Maximum Reverse Leakage I _R @ V _R (µA)	Maximum Temperature coefficient of V _{BR} (%/°C)	Agency Approval 
		UNI	BI		MIN	MAX						
P6SMB6.8A	P6SMB6.8CA	6V8A	6V8C	5.80	6.45	7.14	10	10.5	58.1	1000	0.041	X
P6SMB7.5A	P6SMB7.5CA	7V5A	7V5C	6.40	7.13	7.88	10	11.3	54.0	500	0.054	X
P6SMB8.2A	P6SMB8.2CA	8V2A	8V2C	7.02	7.79	8.61	10	12.1	50.4	200	0.058	X
P6SMB9.1A	P6SMB9.1CA	9V1A	9V1C	7.78	8.65	9.55	1	13.4	45.5	50	0.063	X
P6SMB10A	P6SMB10CA	10A	10C	8.55	9.50	10.50	1	14.5	42.1	10	0.066	X
P6SMB11A	P6SMB11CA	11A	11C	9.40	10.50	11.60	1	15.6	39.1	5	0.069	X
P6SMB12A	P6SMB12CA	12A	12C	10.20	11.40	12.60	1	16.7	36.5	5	0.071	X
P6SMB13A	P6SMB13CA	13A	13C	11.10	12.40	13.70	1	18.2	33.5	1	0.074	X
P6SMB15A	P6SMB15CA	15A	15C	12.80	14.30	15.80	1	21.2	28.8	1	0.076	X
P6SMB16A	P6SMB16CA	16A	16C	13.60	15.20	16.80	1	22.5	27.1	1	0.080	X
P6SMB18A	P6SMB18CA	18A	18C	15.30	17.10	18.90	1	25.5	24.2	1	0.083	X
P6SMB20A	P6SMB20CA	20A	20C	17.10	19.00	21.00	1	27.7	22.0	1	0.085	X
P6SMB22A	P6SMB22CA	22A	22C	18.80	20.90	23.10	1	30.6	19.9	1	0.088	X
P6SMB24A	P6SMB24CA	24A	24C	20.50	22.80	25.20	1	33.2	18.4	1	0.091	X
P6SMB27A	P6SMB27CA	27A	27C	23.10	25.70	28.40	1	37.5	16.3	1	0.092	X
P6SMB30A	P6SMB30CA	30A	30C	25.60	28.50	31.50	1	41.4	14.7	1	0.093	X
P6SMB33A	P6SMB33CA	33A	33C	28.20	31.40	34.70	1	45.7	13.3	1	0.094	X
P6SMB36A	P6SMB36CA	36A	36C	30.80	34.20	37.80	1	49.9	12.2	1	0.096	X
P6SMB39A	P6SMB39CA	39A	39C	33.30	37.10	41.00	1	53.9	11.3	1	0.097	X
P6SMB43A	P6SMB43CA	43A	43C	36.80	40.90	45.20	1	59.3	10.3	1	0.098	X
P6SMB47A	P6SMB47CA	47A	47C	40.20	44.70	49.40	1	64.8	9.4	1	0.099	X
P6SMB51A	P6SMB51CA	51A	51C	43.60	48.50	53.60	1	70.1	8.7	1	0.100	X
P6SMB56A	P6SMB56CA	56A	56C	47.80	53.20	58.80	1	77.0	7.9	1	0.101	X
P6SMB58A	P6SMB58CA	58A	58C	52.78	55.10	60.90	1	79.8	7.7	1	0.101	-
P6SMB62A	P6SMB62CA	62A	62C	53.00	58.90	65.10	1	85.0	7.2	1	0.102	X
P6SMB68A	P6SMB68CA	68A	68C	58.10	64.60	71.40	1	92.0	6.6	1	0.103	X
P6SMB75A	P6SMB75CA	75A	75C	64.10	71.30	78.80	1	103.0	5.9	1	0.104	X
P6SMB82A	P6SMB82CA	82A	82C	70.10	77.90	86.10	1	113.0	5.4	1	0.105	X
P6SMB91A	P6SMB91CA	91A	91C	77.80	86.50	95.50	1	125.0	4.9	1	0.106	X
P6SMB100A	P6SMB100CA	100A	100C	85.50	95.00	105.00	1	137.0	4.5	1	0.106	X
P6SMB110A	P6SMB110CA	110A	110C	94.00	105.00	116.00	1	152.0	4.0	1	0.107	X
P6SMB120A	P6SMB120CA	120A	120C	102.00	114.00	126.00	1	165.0	3.7	1	0.107	X
P6SMB130A	P6SMB130CA	130A	130C	111.00	124.00	137.00	1	179.0	3.4	1	0.107	X
P6SMB150A	P6SMB150CA	150A	150C	128.00	143.00	158.00	1	207.0	2.9	1	0.108	X
P6SMB160A	P6SMB160CA	160A	160C	136.00	152.00	168.00	1	219.0	2.8	1	0.108	X
P6SMB170A	P6SMB170CA	170A	170C	145.00	162.00	179.00	1	234.0	2.6	1	0.108	X
P6SMB180A	P6SMB180CA	180A	180C	154.00	171.00	189.00	1	246.0	2.5	1	0.108	X
P6SMB200A	P6SMB200CA	200A	200C	171.00	190.00	210.00	1	274.0	2.2	1	0.108	X
P6SMB220A	P6SMB220CA	220A	220C	185.00	209.00	231.00	1	328.0	1.9	1	0.110	X
P6SMB250A	P6SMB250CA	250A	250C	214.00	237.00	263.00	1	344.0	1.8	1	0.110	X
P6SMB300A	P6SMB300CA	300A	300C	256.00	285.00	315.00	1	414.0	1.5	1	0.110	X
P6SMB350A*	P6SMB350CA*	350A	350C	300.00	332.00	368.00	1	482.0	1.7	1	0.112	X
P6SMB400A*	P6SMB400CA*	400A	400C	342.00	380.00	420.00	1	548.0	1.5	1	0.112	X
P6SMB440A*	P6SMB440CA*	440A	440C	376.00	418.00	462.00	1	602.0	1.4	1	0.112	X
P6SMB480A*	P6SMB480CA*	480A	480C	408.00	456.00	504.00	1	658.0	1.3	1	0.112	X
P6SMB510A*	P6SMB510CA*	510A	510C	434.00	485.00	535.00	1	698.0	1.2	1	0.112	X
P6SMB530A*	P6SMB530CA*	530A	530C	451.00	503.50	556.50	1	725.0	1.2	1	0.112	X
P6SMB540A*	P6SMB540CA*	540A	540C	460.00	513.00	567.00	1	740.0	1.1	1	0.112	X
P6SMB550A*	P6SMB550CA*	550A	550C	468.00	522.50	577.50	1	760.0	1.1	1	0.112	X
P6SMB600A*	P6SMB600CA*	600A	600C	512.00	570.00	630.00	1	828.0	1.0	1	0.112	-

For bidirectional type having V_R of 10 volts and less, the I_R limit is double.
 For stack-die parts, use * to label the part number.

I-V Curve Characteristics

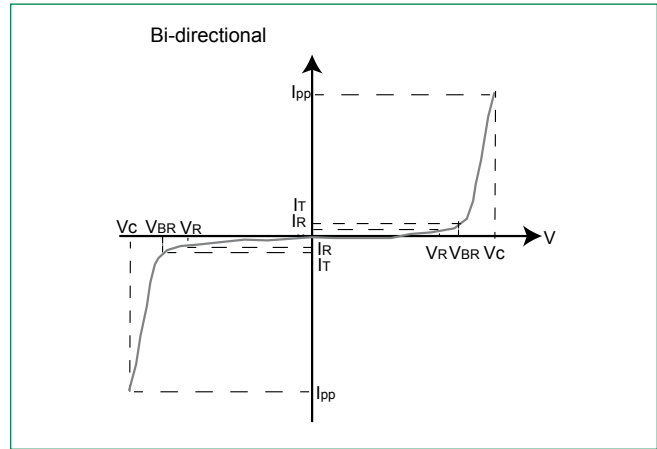
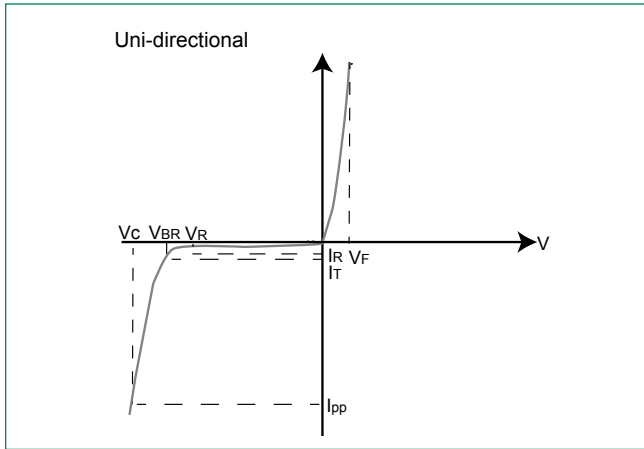

- P_{PPM} Peak Pulse Power Dissipation** – Max power dissipation ($V_C * I_{pp}$)
- V_R Stand-off Voltage** – Maximum voltage that can be applied to the TVS without operation
- V_{BR} Breakdown Voltage** – Maximum voltage that flows through the TVS at a specified test current (I_T)
- V_C Clamping Voltage** – Peak voltage measured across the TVS at a specified I_{ppm} (peak impulse current)
- I_R Reverse Leakage Current** – Current measured at V_R
- V_F Forward Voltage Drop for Uni-directional**

Ratings and Characteristic Curves ($T_A=25^\circ\text{C}$ unless otherwise noted)

Figure 1 - TVS Transients Clamping Waveform

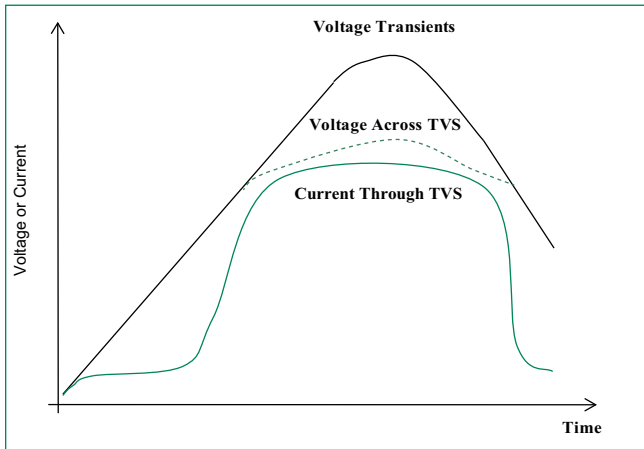
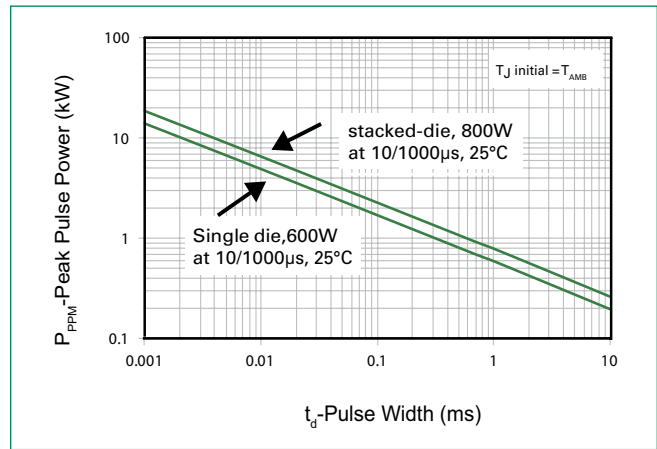

Figure 2 - Peak Pulse Power Rating



Ratings and Characteristic Curves ($T_A=25^\circ\text{C}$ unless otherwise noted) (Continued)

Figure 3 - Peak Pulse Power Derating Curve

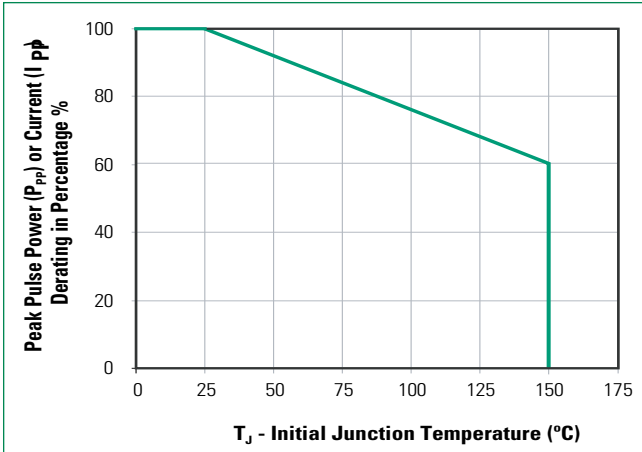

Figure 4 - Pulse Waveform

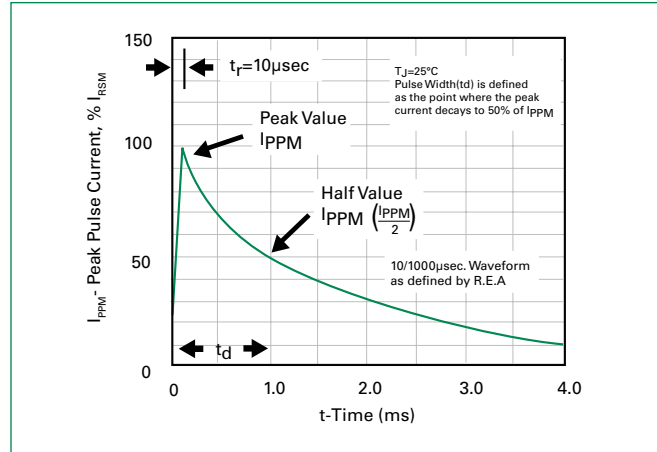

Figure 5 - Typical Junction Capacitance

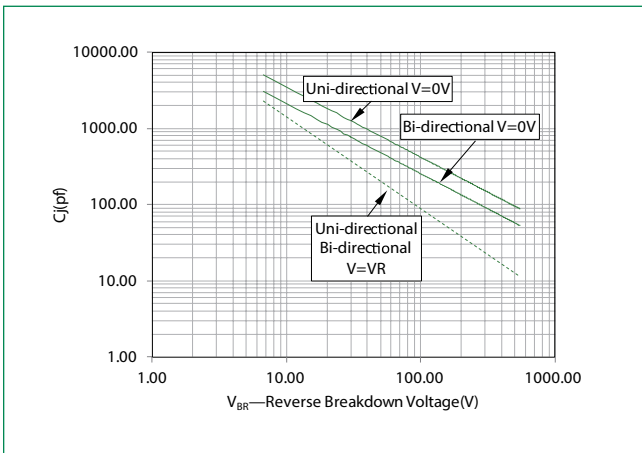

Figure 6 - Typical Transient Thermal Impedance

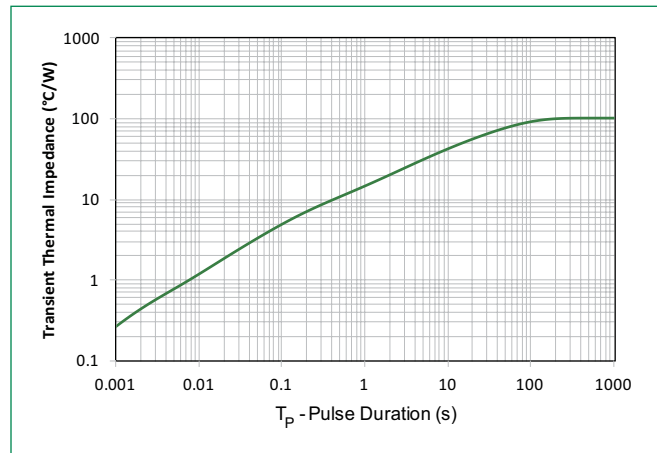

Figure 7 - Maximum Non-Repetitive Peak Forward Surge Current Uni-Directional Only

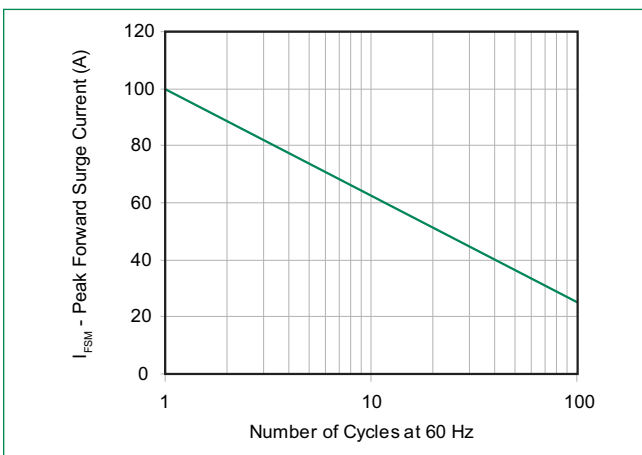
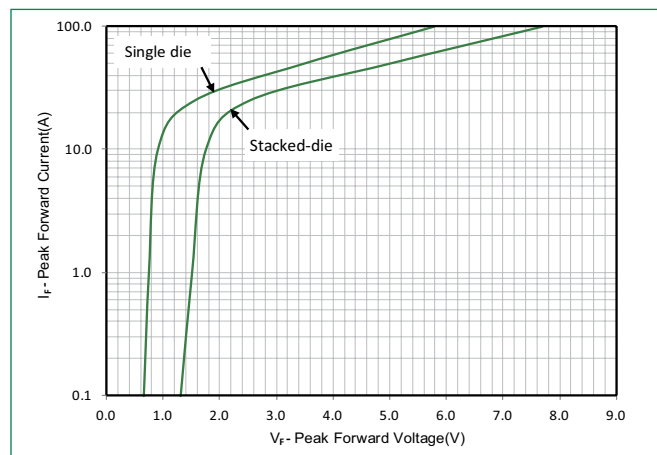
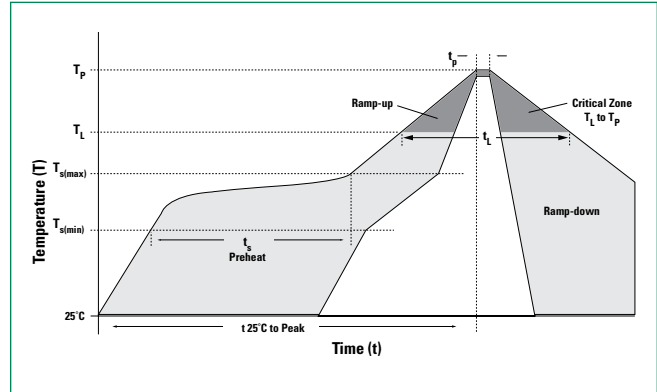

Figure 8 - Peak Forward Voltage Drop vs Peak Forward Current (Typical Values)



Soldering Parameters

Reflow Condition		Pb-Free assembly
Pre Heat	- Temperature Min ($T_{s(min)}$)	150°C
	- Temperature Max ($T_{s(max)}$)	200°C
	- Time (min to max) (t_s)	60 – 120 secs
Average ramp up rate (Liquidus Temp (T_L) to peak)		3°C/second max
$T_{s(max)}$ to T_L - Ramp-up Rate		3°C/second max
Reflow	- Temperature (T_L) (Liquidus)	217°C
	- Time (min to max) (t_L)	60 – 150 seconds
Peak Temperature (T_p)		260 ^{+0/-5} °C
Time within 5°C of actual peak Temperature (t_p)		30 seconds Max
Ramp-down Rate		6°C/second Max
Time 25°C to peak Temperature (T_p)		8 minutes Max.
Do not exceed		260°C



Physical Specifications

Weight	0.003 ounce, 0.093 grams
Case	JEDEC DO214AA. Molded plastic body over glass passivated junction
Polarity	Color band denotes cathode except for bidirectional versions
Terminal	Matte Tin-plated leads, Solderable per JESD22-B102

Environmental Specifications

High Temp. Storage	JESD22-A103
HTRB	JESD22-A108
Temperature Cycling	JESD22-A104
MSL	JEDEC-J-STD-020, Level 1
H3TRB	JESD22-A101
RSH	JESD22-A111

Dimensions

DO-214AA (SMB J-Bend)

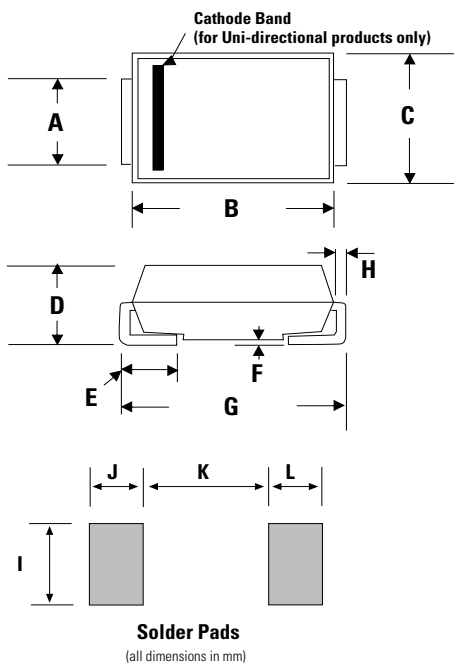

Dimensions	Inches		Millimeters	
	Min	Max	Min	Max
A	0.076	0.086	1.930	2.200
B	0.160	0.187	4.060	4.750
C	0.130	0.155	3.300	3.940
D	0.078	0.103	1.990	2.610
E	0.030	0.060	0.760	1.520
F	-	0.008	-	0.203
G	0.205	0.220	5.210	5.590
H	0.006	0.012	0.152	0.305
I	0.089	-	2.260	-
J	0.085	-	2.160	-
K	-	0.107	-	2.740
L	0.085	-	2.160	-

Part Numbering System

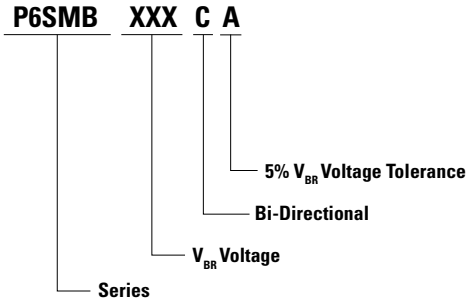

Part Marking System

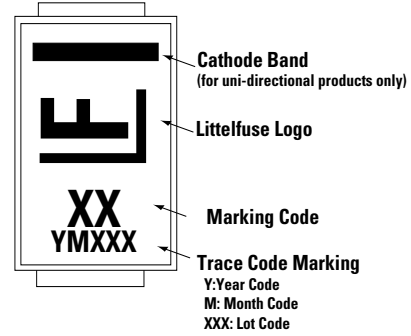

Packaging

Part number	Component Package	Quantity	Packaging Option	Packaging Specification
P6SMBxxxXX	DO-214AA	3000	Tape & Reel - 12mm tape/13" reel	EIA STD RS-481

Tape and Reel Specification

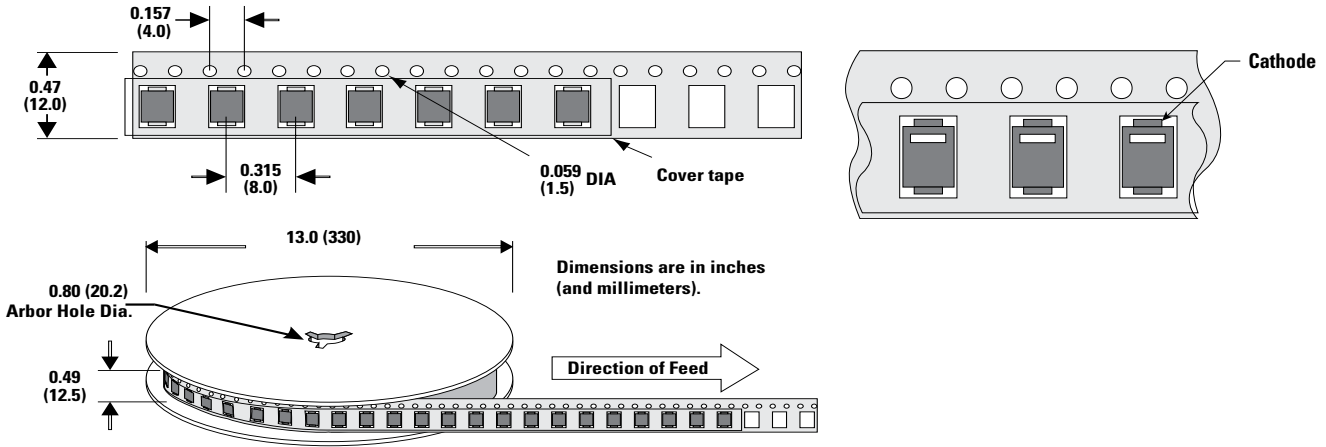

Mouser Electronics

Authorized Distributor

Click to View Pricing, Inventory, Delivery & Lifecycle Information:

Littelfuse:

[P6SMB540](#) [P6SMB300](#) [P6SMB170A](#) [P6SMB400C](#) [P6SMB68A](#) [P6SMB13A](#) [P6SMB350C](#) [P6SMB24CA](#)
[P6SMB10C](#) [P6SMB56C](#) [P6SMB220](#) [P6SMB62C](#) [P6SMB75CA](#) [P6SMB39CA](#) [P6SMB47](#) [P6SMB250C](#) [P6SMB120C](#)
[P6SMB51A](#) [P6SMB91](#) [P6SMB110CA](#) [P6SMB20A](#) [P6SMB220CA](#) [P6SMB6.8C](#) [P6SMB27A](#) [P6SMB15](#) [P6SMB530](#)
[P6SMB18](#) [P6SMB82](#) [P6SMB36A](#) [P6SMB120CA](#) [P6SMB22A](#) [P6SMB480](#) [P6SMB56CA](#) [P6SMB68C](#) [P6SMB30A](#)
[P6SMB10](#) [P6SMB180](#) [P6SMB16](#) [P6SMB510A](#) [P6SMB8.2](#) [P6SMB15CA](#) [P6SMB300CA](#) [P6SMB9.1A](#) [P6SMB110](#)
[P6SMB400CA](#) [P6SMB56](#) [P6SMB18CA](#) [P6SMB150CA](#) [P6SMB180CA](#) [P6SMB8.2CA](#) [P6SMB75](#) [P6SMB27C](#)
[P6SMB12CA](#) [P6SMB30CA](#) [P6SMB39A](#) [P6SMB12](#) [P6SMB550](#) [P6SMB47CA](#) [P6SMB12C](#) [P6SMB180C](#)
[P6SMB530A](#) [P6SMB150](#) [P6SMB36C](#) [P6SMB200A](#) [P6SMB6.8CA](#) [P6SMB100C](#) [P6SMB82A](#) [P6SMB8.2C](#)
[P6SMB43A](#) [P6SMB22CA](#) [P6SMB100A](#) [P6SMB480A](#) [P6SMB100CA](#) [P6SMB540CA](#) [P6SMB160A](#) [P6SMB160CA](#)
[P6SMB200CA](#) [P6SMB7.5](#) [P6SMB170C](#) [P6SMB160C](#) [P6SMB350CA](#) [P6SMB43CA](#) [P6SMB24A](#) [P6SMB13](#)
[P6SMB200C](#) [P6SMB13C](#) [P6SMB6.8](#) [P6SMB7.5C](#) [P6SMB68CA](#) [P6SMB47A](#) [P6SMB43C](#) [P6SMB33A](#) [P6SMB110C](#)
[P6SMB550C](#) [P6SMB9.1C](#) [P6SMB110A](#) [P6SMB250CA](#) [P6SMB18A](#) [P6SMB540A](#) [P6SMB51C](#)