

30V N-CHANNEL ENHANCEMENT MODE MOSFET IN SOT89 PACKAGE

Product Summary

$V_{(BR)DSS}$	$R_{DS(on)}$ Max	I_D max $T_A = 25^\circ C$ (Note 5)
30V	120m Ω @ $V_{GS} = 10V$	3.3A
	180m Ω @ $V_{GS} = 4.5V$	2.7A

Features and Benefits

- Low On-Resistance
- Low Threshold
- Fast Switching Speed
- Low Gate Drive
- **Lead Free/RoHS Compliant (Note 1)**
- **"Green" Device (Note 2)**
- **Qualified to AEC-Q101 Standards for High Reliability**

Description and Applications

This MOSFET has been designed to minimize the on-state resistance ($R_{DS(on)}$) and yet maintain superior switching performance, making it ideal for high efficiency power management applications.

- DC-DC Converters
- Power Management functions
- Motor control

Mechanical Data

- Case: SOT89
- Case Material: Molded Plastic, "Green" Molding Compound. UL Flammability Classification Rating 94V-0
- Moisture Sensitivity: Level 1 per J-STD-020
- Terminals: Matte Tin Finish
- Weight: 0.052 grams (approximate)



Top View

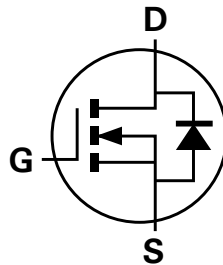

Device symbol

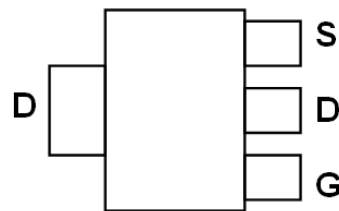

Pin-out Top

Ordering Information (Note 3)

Product	Marking	Reel size (inches)	Tape width (mm)	Quantity per reel
ZXMN3A01ZTA	1S8	7	12	1,000

- Notes:
1. No purposefully added lead.
 2. Diodes Inc's "Green" Policy can be found on our website at <http://www.diodes.com>
 3. For packaging details, go to our website at <http://www.diodes.com>

Marking Information

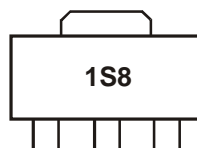

1S8 = Product type Marking Code

Maximum Ratings @T_A = 25°C unless otherwise specified

Characteristic		Symbol	Value	Unit
Drain-Source Voltage		V _{DSS}	30	V
Gate-Source Voltage		V _{GSS}	±20	V
Continuous Drain Current	Steady State	@ V _{GS} = 10V ; T _A = 25°C (Note 5)	3.3	A
		@ V _{GS} = 10V ; T _A = 75°C (Note 5)	2.7	
		@ V _{GS} = 10V ; T _A = 75°C (Note 4)	2.2	
Pulsed Drain Current (Note 6)		I _{DM}	20	A
Continuous Source Current (Body Diode) (Note 5)		I _S	3.3	A
Pulsed Source Current (Body Diode) (Note 6)		I _{SM}	20	A

Thermal Characteristics @T_A = 25°C unless otherwise specified

Characteristic		Symbol	Value	Unit
Power Dissipation	(Note 4)	P _D	0.97	W
	(Note 5)		2.12	W
Thermal Resistance, Junction to Ambient	(Note 4)	R _{θJA}	129	°C/W
	(Note 5)		59	°C/W
Operating and Storage Temperature Range		T _J , T _{STG}	-55 to +150	°C

- Notes: 4. Device mounted on FR-4 substrate PC board, 2oz copper, with minimum recommended pad layout
 5. Device mounted on 25mm X 25mm FR-4 substrate PC board with 2oz copper
 6. Single pulse rating - 25mm x 25mm FR4 PCB, D=0.02, pulse width 300us – pulse width limited by maximum junction temperature.

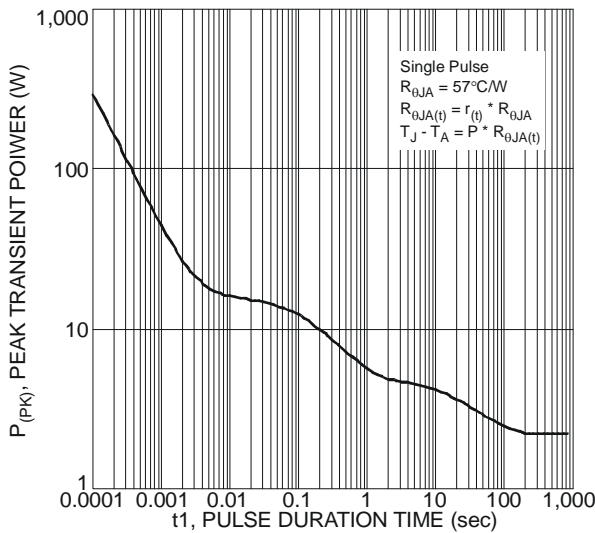

Fig. 1 Single Pulse Maximum Power Dissipation

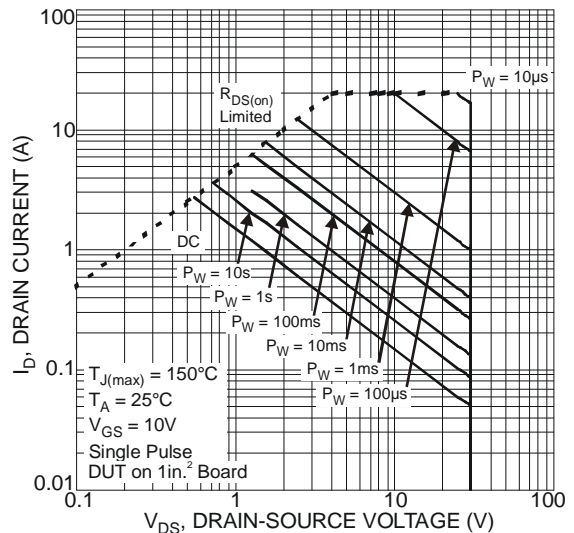

Fig. 2 SOA, Safe Operation Area

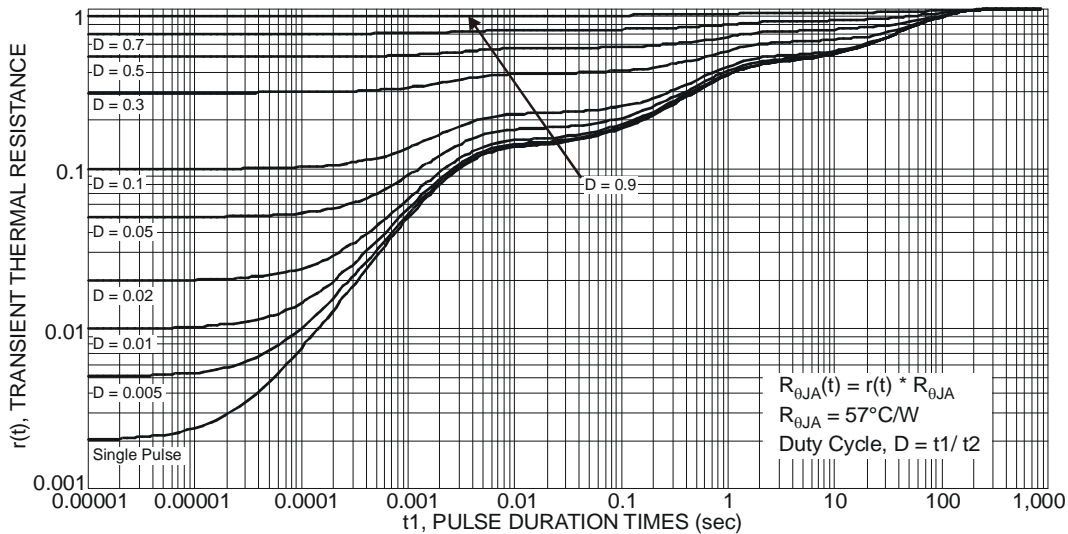

Fig. 3 Transient Thermal Resistance

Electrical Characteristics @T_A = 25°C unless otherwise specified

Characteristic	Symbol	Min	Typ	Max	Unit	Test Condition
OFF CHARACTERISTICS						
Drain-Source Breakdown Voltage	BV _{DSS}	30	-	-	V	V _{GS} = 0V, I _D = 250μA
Zero Gate Voltage Drain Current T _J = 25°C	I _{DSS}	-	-	0.5	μA	V _{DS} = 30V, V _{GS} = 0V
Gate-Source Leakage	I _{GSS}	-	-	100	nA	V _{GS} = ±20V, V _{DS} = 0V
ON CHARACTERISTICS						
Gate Threshold Voltage	V _{GS(th)}	1	-	-	V	V _{DS} = V _{GS} , I _D = 250μA
Static Drain-Source On-Resistance (Note 7)	R _{DS(on)}	-	0.106	120	mΩ	V _{GS} = 10V, I _D = 2.5A
			-	180		V _{GS} = 4.5V, I _D = 2A
Forward Transconductance (Note 7 & 9)	g _{FS}	-	3.5	-	S	V _{DS} = 4.5V, I _D = 2.5A
Diodes Forward Voltage (Note 7)	V _{SD}	-	0.85	0.95	V	T _J = 25°C, I _S = 1.7A, V _{GS} = 0V
DYNAMIC CHARACTERISTICS						
Input Capacitance (Note 8 & 9)	C _{iss}	-	186	-	pF	V _{DS} = 25V, V _{GS} = 0V, f = 1.0MHz
Output Capacitance (Note 8 & 9)	C _{oss}	-	48	-	pF	
Reverse Transfer Capacitance (Note 8 & 9)	C _{rss}	-	29	-	pF	
Gate Charge (Note 8 & 9)	Q _g	-	2.6	-	nC	V _{GS} = 4.5V, V _{DS} = 15V, I _D = 2.5A
Total Gate Charge (Note 8 & 9)	Q _g	-	5.0	-	nC	V _{GS} = 10V, V _{DS} = 15V, I _D = 2.5A
Gate-Source Charge (Note 8 & 9)	Q _{gs}	-	0.8	-	nC	
Gate-Drain Charge (Note 8 & 9)	Q _{gd}	-	1.2	-	nC	
Reverse Recovery Time (Note 9)	t _{rr}		17.7		ns	T _J = 25°C, I _S = 2.5A, di/dt = 100A/μs
Reverse Recovery Charge (Note 9)	Q _{rr}		13.0		nC	
Turn-On Delay Time (Note 8 & 9)	t _{D(on)}	-	2.6	-	ns	V _{GS} = 10V, V _{DD} = 15V, R _G = 6Ω, I _D = 2.5A
Turn-On Rise Time (Note 8 & 9)	t _r	-	4.1	-	ns	
Turn-Off Delay Time (Note 8 & 9)	t _{D(off)}	-	13.5	-	ns	
Turn-Off Fall Time (Note 8 & 9)	t _f	-	3.6	-	ns	

Notes: 7. Measured under pulsed conditions. Pulse width ≤ 300μs; duty cycle ≤ 2%.
8. Switching characteristics are independent of operating junction temperature.
9. For design aid only, not subject to production testing.

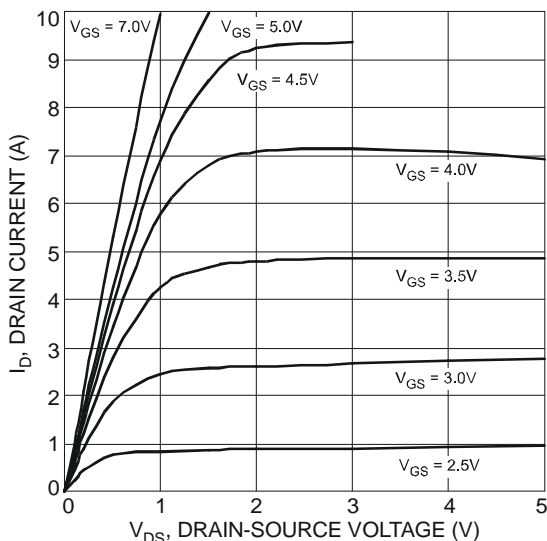

Fig. 4 Typical Output Characteristic, T_A = 25°C

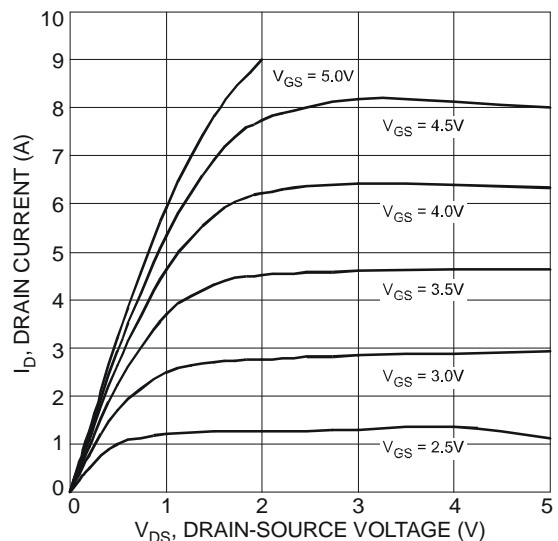

Fig. 5 Typical Output Characteristic, T_A = 150°C

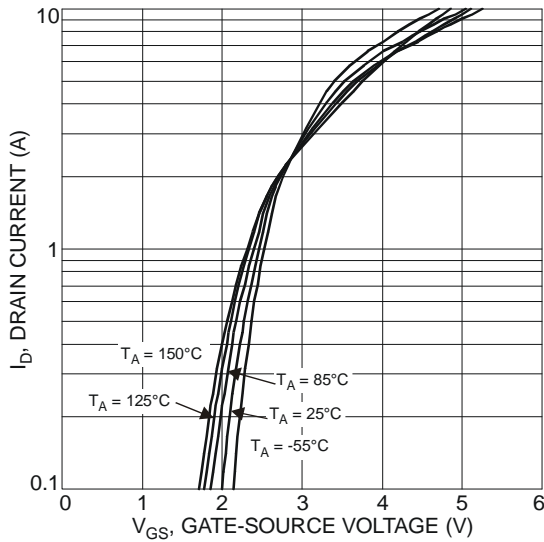

Fig. 6 Typical Transfer Characteristics

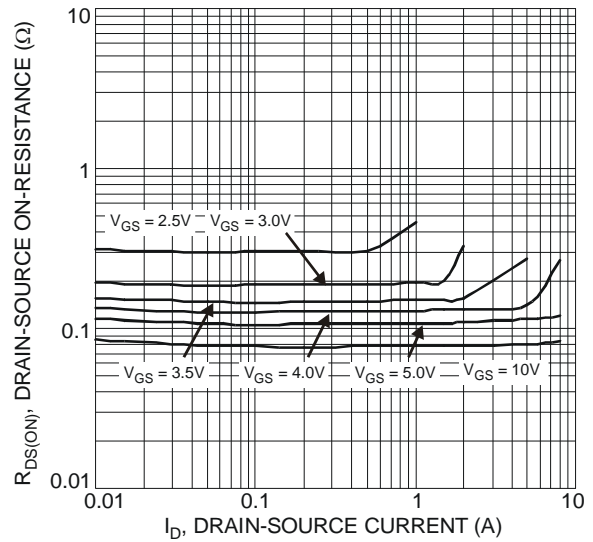

Fig. 7 Typical On-Resistance vs. Drain Current and Gate Voltage

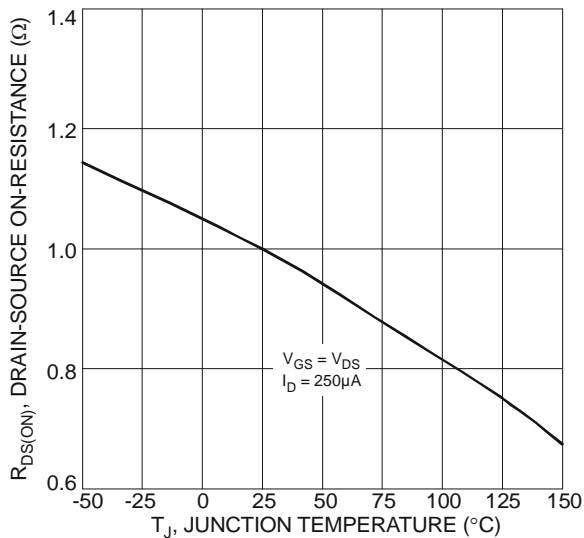

Fig. 8 On-Resistance Variation with Temperature

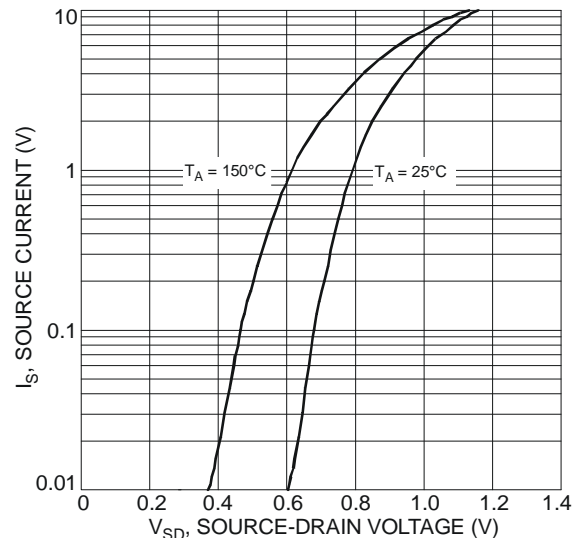

Fig. 9 Diode Forward Voltage vs. Current

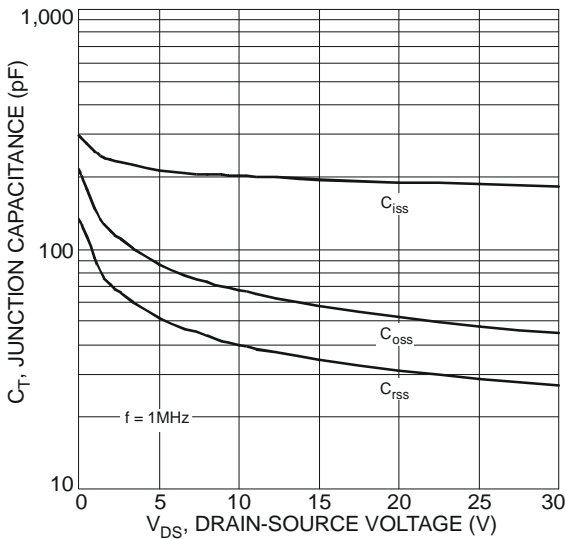

Fig. 10 Typical Junction Capacitance

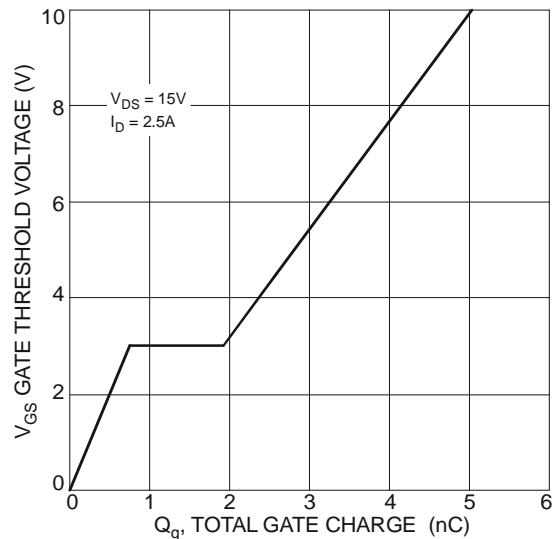
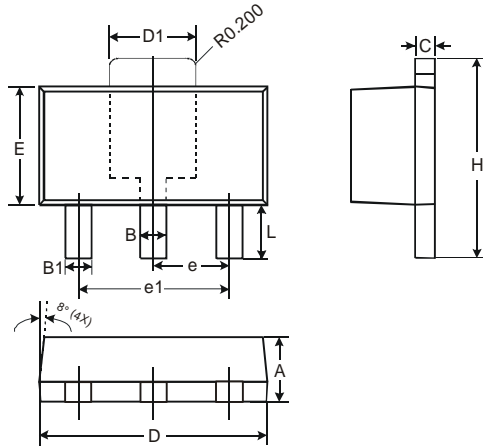

Fig. 11 Gate Charge

Package Outline Dimensions



SOT89		
Dim	Min	Max
A	1.40	1.60
B	0.44	0.62
B1	0.35	0.54
C	0.35	0.43
D	4.40	4.60
D1	1.52	1.83
E	2.29	2.60
e	1.50 Typ	
e1	3.00 Typ	
H	3.94	4.25
L	0.89	1.20
All Dimensions in mm		

Suggested Pad Layout

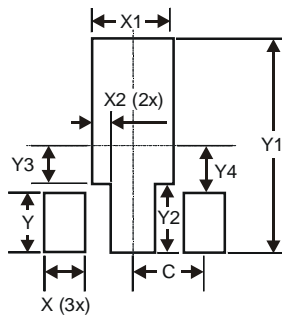

Dimensions	Value (in mm)
X	0.900
X1	1.733
X2	0.416
Y	1.300
Y1	4.600
Y2	1.475
Y3	0.950
Y4	1.125
C	1.500

IMPORTANT NOTICE

DIODES INCORPORATED MAKES NO WARRANTY OF ANY KIND, EXPRESS OR IMPLIED, WITH REGARDS TO THIS DOCUMENT, INCLUDING, BUT NOT LIMITED TO, THE IMPLIED WARRANTIES OF MERCHANTABILITY AND FITNESS FOR A PARTICULAR PURPOSE (AND THEIR EQUIVALENTS UNDER THE LAWS OF ANY JURISDICTION).

Diodes Incorporated and its subsidiaries reserve the right to make modifications, enhancements, improvements, corrections or other changes without further notice to this document and any product described herein. Diodes Incorporated does not assume any liability arising out of the application or use of this document or any product described herein; neither does Diodes Incorporated convey any license under its patent or trademark rights, nor the rights of others. Any Customer or user of this document or products described herein in such applications shall assume all risks of such use and will agree to hold Diodes Incorporated and all the companies whose products are represented on Diodes Incorporated website, harmless against all damages.

Diodes Incorporated does not warrant or accept any liability whatsoever in respect of any products purchased through unauthorized sales channel. Should Customers purchase or use Diodes Incorporated products for any unintended or unauthorized application, Customers shall indemnify and hold Diodes Incorporated and its representatives harmless against all claims, damages, expenses, and attorney fees arising out of, directly or indirectly, any claim of personal injury or death associated with such unintended or unauthorized application.

Products described herein may be covered by one or more United States, international or foreign patents pending. Product names and markings noted herein may also be covered by one or more United States, international or foreign trademarks.

LIFE SUPPORT

Diodes Incorporated products are specifically not authorized for use as critical components in life support devices or systems without the express written approval of the Chief Executive Officer of Diodes Incorporated. As used herein:

A. Life support devices or systems are devices or systems which:

1. are intended to implant into the body, or
2. support or sustain life and whose failure to perform when properly used in accordance with instructions for use provided in the labeling can be reasonably expected to result in significant injury to the user.

B. A critical component is any component in a life support device or system whose failure to perform can be reasonably expected to cause the failure of the life support device or to affect its safety or effectiveness.

Customers represent that they have all necessary expertise in the safety and regulatory ramifications of their life support devices or systems, and acknowledge and agree that they are solely responsible for all legal, regulatory and safety-related requirements concerning their products and any use of Diodes Incorporated products in such safety-critical, life support devices or systems, notwithstanding any devices- or systems-related information or support that may be provided by Diodes Incorporated. Further, Customers must fully indemnify Diodes Incorporated and its representatives against any damages arising out of the use of Diodes Incorporated products in such safety-critical, life support devices or systems.

Copyright © 2012, Diodes Incorporated

www.diodes.com