

10 - Terminal blocks

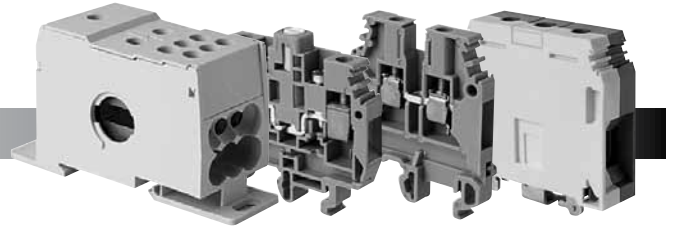

10

SNK terminal blocks..... 10.1 – 10.72

General information	
Features and benefits	10.1 - 10.3
Accessories	10.4
Marking solutions	10.5
Panorama.....	10.6 - 10.7
Ordering details	
ZS4 Screw clamp terminal blocks.....	10.8
ZS6 Screw clamp terminal blocks.....	10.9
ZS10 Screw clamp terminal blocks.....	10.10
ZS16 Screw clamp terminal blocks.....	10.11
ZS35 Screw clamp terminal blocks.....	10.12
ZS70 Screw clamp terminal blocks.....	10.13
ZS95 Screw clamp terminal blocks.....	10.14
ZS4-R1 Screw clamp terminal blocks.....	10.15
ZS4-D2 Screw clamp terminal blocks.....	10.16
ZS4-D1 Screw clamp terminal blocks.....	10.17
ZS6-D2 Screw clamp terminal blocks.....	10.18
ZS6-D1 Screw clamp terminal blocks.....	10.19
ZS4-PE Screw clamp terminal blocks.....	10.20
ZS6-PE Screw clamp terminal blocks.....	10.21
ZS10-PE Screw clamp terminal blocks.....	10.22
ZS16-PE Screw clamp terminal blocks.....	10.23
ZS35-PE Screw clamp terminal blocks.....	10.24
ZS70-PE Screw clamp terminal blocks.....	10.25
ZS95-PE Screw clamp terminal blocks.....	10.26
ZS6-D1-PE Screw clamp terminal blocks.....	10.27
ZS6-D2-PE Screw clamp terminal blocks.....	10.28
ZS4-S Screw clamp terminal blocks.....	10.29
ZS6-S Screw clamp terminal blocks.....	10.30
ZS10-S Screw clamp terminal blocks.....	10.31
ZS4-S-T Screw clamp terminal blocks.....	10.32
ZS4-S-R1 Screw clamp terminal blocks.....	10.33
ZS4-S-T-R1 Screw clamp terminal blocks.....	10.34
ZS4-SP Screw clamp terminal blocks.....	10.35
ZS10-SP Screw clamp terminal blocks.....	10.36
ZS4-SP-T2 Screw clamp terminal blocks.....	10.37
ZS4-SP-R1 Screw clamp terminal blocks.....	10.38
ZS4-SP-T2-R1 Screw clamp terminal blocks.....	10.39
ZS4-S-R2 Screw clamp terminal blocks.....	10.40
ZS4-S-R3 Screw clamp terminal blocks.....	10.41
ZS4-SF Screw clamp terminal blocks.....	10.42
ZS4-SF-T Screw clamp terminal blocks.....	10.43
ZS4-SF-R Screw clamp terminal blocks.....	10.44
ZS4-SF-R Screw clamp terminals blocks.....	10.45
ZS4-SF1 Screw clamp terminal blocks.....	10.46
ZS4-SF1-T Screw clamp terminal blocks.....	10.47
ZS4-SF1-R Screw clamp terminal blocks.....	10.48
ZS4-SF1-R Screw clamp terminal blocks.....	10.49
PR30 Mounting rail.....	10.50

PR3.Z2 Mounting rail.....	10.50
PR50 Mounting rail.....	10.51
PR5 Mounting rail.....	10.51
PR4 Mounting rail.....	10.52
AMS 500 Marking table.....	10.53
Marking systems	10.54
MC512 Terminal block markers.....	10.55
MC512PA Terminal block markers.....	10.55
MC512PA Terminal block markers.....	10.56 - 10.59
MC612PA Terminal block markers.....	10.60 - 10.64
MC812 Terminal block markers.....	10.65 - 10.69
SAT Terminal block markers.....	10.70
UMH Universal wire markers holder.....	10.71
MCLH Labels.....	10.71

SNA terminal blocks..... 10.73 – 10.124

Features and benefits		10.73
Ordering details		
Feed through and ground terminal blocks, screw clamp.....	10.74 - 10.82	
Multi level feed through terminal blocks, screw clamp.....	10.83 - 10.84	
Three level sensor.....	10.85	
Heavy duty switch terminal blocks.....	10.86	
Heavy duty switch and fuse holder terminal blocks.....	10.87	
Fuse holder terminal blocks.....	10.88 - 10.89	
Fuse holder terminal blocks & heavy duty switch.....	10.90	
Fuse holder terminal blocks, screw clamp.....	10.91, 10.101	
Feed through and ground terminal blocks, spring clamp.....	10.92 - 10.94	
Feed through terminal blocks - 3 level.....	10.95	
Feed through and ground terminal blocks - 4 level.....	10.96	
Fuse holder terminal blocks, spring clamp.....	10.97	
Feed through and ground terminal blocks, ADO-Screw.....	10.98 - 10.100	
Fuse holder terminal blocks, ADO-Screw.....	10.101	
Feed through and ground terminal blocks, ADO-ADO.....	10.102 - 10.104	
Fuse holder terminal blocks, ADO-ADO.....	10.105	
Accessories.....	10.106, 10.114 - 10.116	
Power terminal blocks.....	10.107 - 10.108	
Distribution blocks.....	10.109 - 10.113	
Marking		
Marking for terminal blocks.....	10.117 - 10.121	
Marking systems.....	10.122 - 10.123	
Custom top marker continuous strips.....	10.121	
Marking systems, AMS 500.....	10.122	
Marking systems, HTP500.....	10.123	

Interfast terminal blocks..... 10.125 – 10.130





Features and benefits		10.125
Make your PLC wiring easy!.....	10.126	
Choose flexibility.....	10.127	
Interfast series.....	10.128	
Tools ready to use and ready to "click".....	10.129	

Glossary for accessories





Product names (cont.)

M 4/6

High density blocks :

-  M 4/6.D2 : Two level blocks (levels are independent)
-  M 4/6.D1 : Two level blocks (levels are interconnected)
-  D 4/6.T3 : 3 level blocks (3 independent levels)
-  D 4/6.T1 : all 3 levels are interconnected





Switch blocks :

-  M 4/6.S... : Switch blocks
-  M 4/6.SNB... : Blade switch blocks
-  M 4/6.SB... : Plug type switch blocks
-  M 4/6.ST... : Test and measurement switch blocks

Product names (cont.)

M 4/8

Fuse blocks :

-  M 4/8.SF... : Switch fuse blocks
-  M 4/8.SFD : With LED fusion indicator
-  M 4/8.SFL : With neon lamp indicator
-  M 4/8.SF..T : With test socket screws
-  M 4/8.SN : With neutral bar in place on fuse (neutral switching)

Product names (cont.)

Spring clamp terminal blocks

- D 4/6. (2L) • Feed-through blocks : 2 spring clamps
- D 4/6. (3L) • Feed-through blocks : 3 spring clamps
- D 4/6. (4L) • Feed-through blocks : 4 spring clamps
- D 4/6. (2L.2L) • Terminal block with 4 spring clamps on 2 separate circuits

HOW TO READ CARTON LABELS

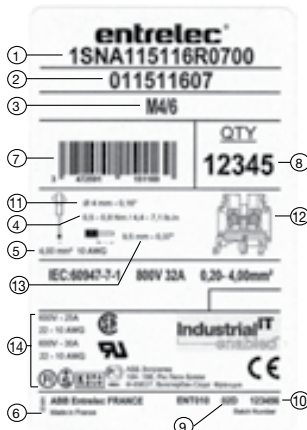

LEGEND FOR CARTON LABEL

- | | |
|------------------------|----------------------------|
| 1 15 digit part number | 8 Quantity |
| 2 9 digit part number | 9 Manufacturing date code |
| 3 Description | 10 Batch number |
| 4 Recommended torque | 11 Recommended screwdriver |
| 5 Rated wire size | 12 Pole of the product |
| 6 "Made in France" | 13 Wire stripping length |
| 7 Bar code | 14 Approvals |

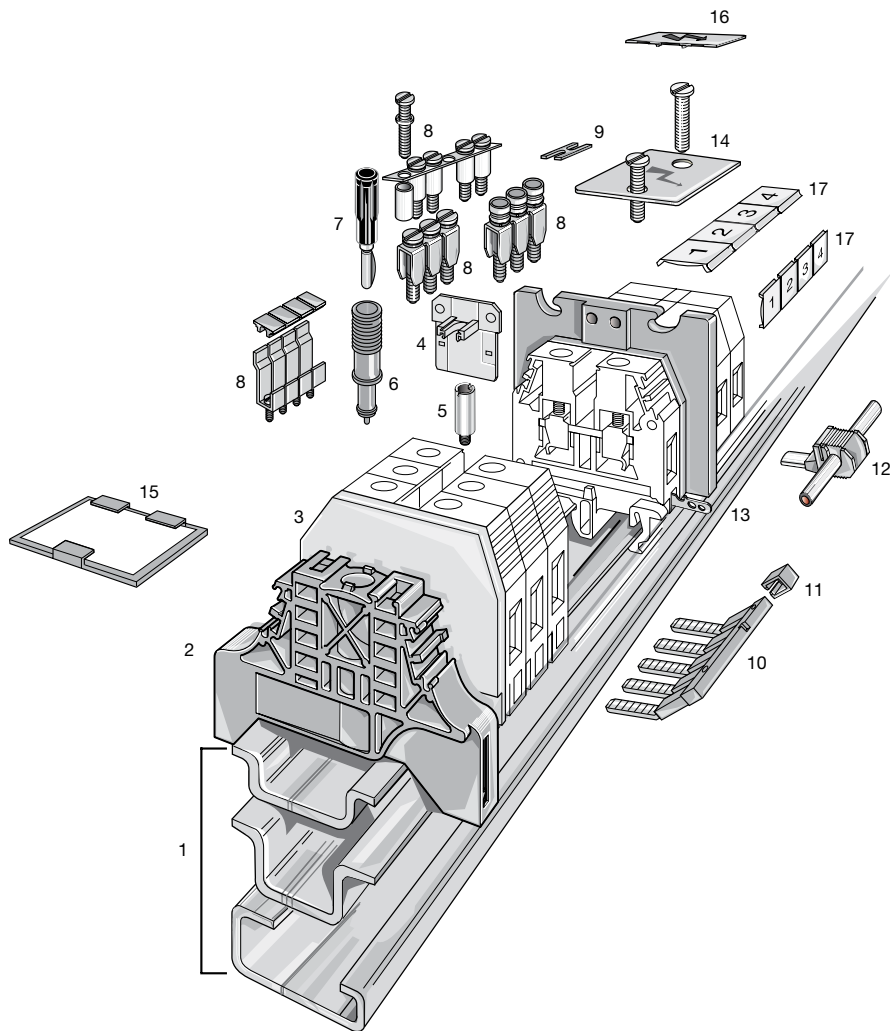

- | | | | |
|--------------------------|----|--------------------------------------|-----|
| 1 Rail..... | PR | 10 Comb type jumper bar | PC |
| 2 End stop | BA | 11 Insulating comb tip..... | EIP |
| 3 End section..... | FE | 12 IDC jumper | AD |
| 4 Circuit separator..... | SC | 13 Shield connector | CB |
| 5 Test socket | AL | 14 Protection label | EP |
| 6 Test device | DC | 15 Marker-holder for end stop | PEB |
| 7 Test plug | FC | 16 Single pole protection label..... | EPU |
| 8 Jumper bar | BJ | 17 Markers | RC |
| 9 Connector plate..... | EL | | |

Type SNK Terminal blocks

ABB Terminal blocks Type SNK

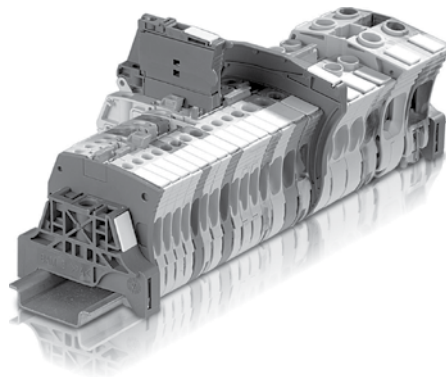

A smart design to support your daily connection challenges

- Marking visible from any direction
- Rail assembly process facilitated
- Facilitated maintenance operations

Rely on our expertise

- UL and worldwide certifications
- Innovation with new patented design
- Reliability: Over 50 years of expertise with screw clamp terminal blocks

Generate savings where it counts

- 1 identical end plate for most of the SNK terminal blocks
- Less terminal blocks and accessories required for a complete electrical installation

Find your preferred marking solution from our universal product offering

- SNK terminal blocks and accessories accept markers cards, self-adhesive paper strips or universal wire marker holders
- Complete marking system choice: ABB automatic printing solutions or manual marking solutions

10

General information

Features and benefits

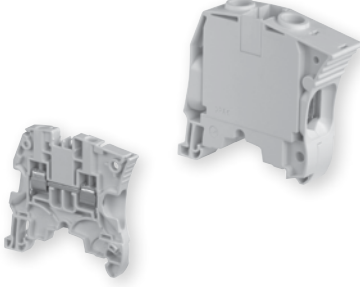
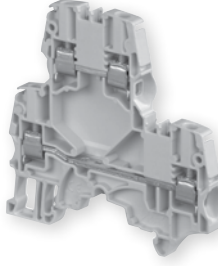
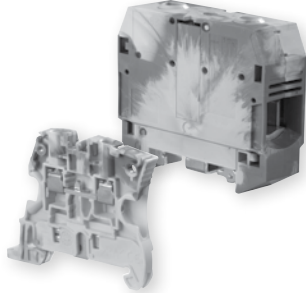
Feed-through Smart Design	Double deck High wiring density for space savings	Ground Reliable rail connection
		
<p>A unique profile for smart use Easy and ergonomic mounting thanks to the unique profile of the terminal blocks:</p> <ul style="list-style-type: none"> - Easy to handle, - Reversed terminals are obvious, eliminating short circuits. <p>Clear marking areas Marking surfaces can be read clearly from any angle in an enclosure and are larger than standard markers in the market.</p> <p>Maximized flexibility The two terminal blocks central channels-aligned from 4 mm² 12 AWG up to 16 mm² 4 AWG terminal blocks-offer flexibility of use:</p> <ul style="list-style-type: none"> - Common and polarity distribution with JB screwless jumper bars, - Power distribution with JB85-3 cross-spacing jumpers, - Continuity control with TP4 or TP2 test adapters, - Advanced testing (simulation, dielectric control, etc.) prior customer acceptance with TC test connectors, - Overvoltage protection and temperature control with PG5-R2 components holder. <p>Reduce use of accessories</p> <ul style="list-style-type: none"> - One unique end section and circuit separator fits all feed-through terminal blocks. 	<p>Offers efficient space reduction for switchgears with space constraints or sensors with multiple connection constraints.</p> <p>All Double Deck terminal blocks have two marking areas as well as two central channels per deck for:</p> <ul style="list-style-type: none"> - Common and polarity distribution with JB screwless jumper bars. - Continuity control or Advanced testing (simulation, dielectric control, etc.) with TP4, TP2 test adapters and TC test connectors, on the upper deck only. 	<p>Snap-in rail connection for rapid installation and removal for 4 mm² 10 AWG up to 16 mm² 4 AWG ground terminal blocks.</p> <p>Simply snap it on the DIN3-TH35 rail for a secure connection.</p> <p>Strict qualification tests, in addition to those required in IEC standard 60947-7-2, have been performed to guarantee the reliability of the snap-in rail connection in mechanical endurance and lifetime performance.</p> <p>Our smart design enables block removal without any risk of damaging the rail connection part.</p> <p>Robust screw rail connection for higher rated sections 35 mm² 0 AWG up to 95 mm² 0000 AWG ground terminal blocks.</p>





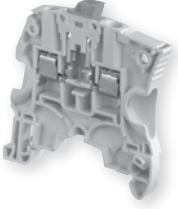
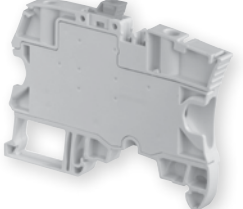
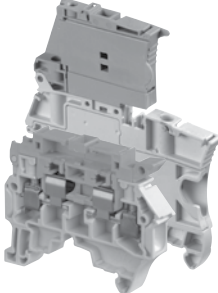
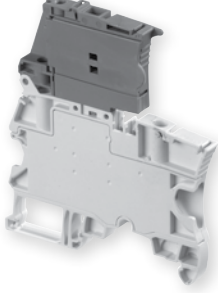
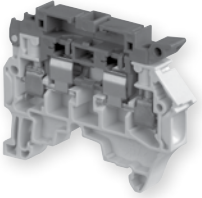

10

General information

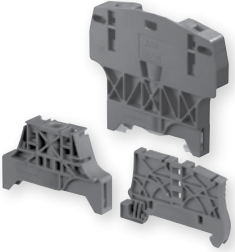
Features and benefits

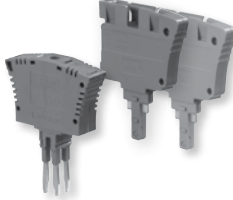

Disconnect			Fuse	
Time saving for test circuit operations			Optimized circuit protection	
Compact	Expert	Aligned with fuse		
				
<p>The ZS4-S compact version has an identical profile to the ZS4 feed-through terminal block for many benefits such as identical end section use</p>	<p>The ZS4-S-R1 expert version has two central jumper channels aligned with the ZS6 feed-through terminal block for convenient alternated distribution</p>	<p>Perfectly adapted for use with fuse terminal blocks</p>	<p>The ZS4-SF fits 5x20 mm fuses for circuit protection</p> <p>It has two central jumper channels for convenient common distribution and it is aligned with ZS4-S-R1 and ZS4-S-R2 disconnect terminal blocks, as well as the ZS6 feed-through terminal block for convenient alternated distribution and reduced wiring.</p>	<p>The ZS4-SF1 fits 5 x 20 mm and 5 x 25 mm fuses for circuit protection</p>
<p>Available with blade or plug for easy circuit opening without disconnecting the wiring.</p> <p>Also available with built-in test socket screws convenient direct connection to the test equipment for the following operations:</p> <ul style="list-style-type: none"> - Voltage control, voltage continuity control or dielectric tests. - Total or partial equipment testing. - Maintenance. 			<p>The ZS4-SF and ZS4-SF1 are based on the latest version of the IEC60947-7-3 standard.</p> <p>The wiring of the terminal block is facilitated and can be done when the fuse holder is in closed position.</p> <ul style="list-style-type: none"> - Easy blown fuse control with the ZS4-SF-R1 and ZS4-SF-R3 available with blown fuse indicator 24-60 V or 115-250 V for quick identification of fuse failures, with low leakage current (< 0.5 mA). This feature enables use on high impedance PLC inputs. - Also available with built-in test socket screws for convenient direct connection to the test equipment for test operations such as voltage control, voltage continuity control or maintenance. 	

General information Accessories

End stops	Jumpers	End sections	Circuit separators
			
<p>Choose between the new compact screwless BAZ1, the robust BAM3 and the high BAZH1 for double deck and blocks up to 35 mm² 0 AWG. All compatible with SNK label holders LH.</p>	<p>Simplify the block interconnection with the isolated screwless jumper with the JB... available for 4 to 16 mm² 10 to 4 AWG terminal blocks.</p>	<p>One end section ES4 for the core feed-through range from 4 mm² to 95 mm² 10 to 000 AWG. Just three ends sections needed for the entire SNK series range.</p>	<p>Separate and easily visualize different parts of your assembly with the universal circuit separator CS-R1.</p>
10			
Testing solutions	Shielding	Covers	Plugs
			
<p>Test your assembly up to 15 poles with the test connector TC... or simply control the voltage with the test adaptor TP for 2, 2.3 or 4 mm test plug diameter.</p>	<p>Ensure the continuity of your shield connection with the SHB... shield connectors providing rapid and convenient installation.</p>	<p>PL... individual terminal block protective covers allow the rapid identification of live circuits. They also limit access to the screw clamp.</p> <p>KCO mounting kit protective covers reliably restrict access to your terminal assembly with the possibility of sealing.</p>	<p>PG5 component plugs ease the component installation (resistors or diodes) with a quick plug-in mounting system which avoids any soldering.</p> <p>PG5-R2 plugs fit into the terminal block's jumper channel for component insertion (resistors, diodes, etc.) between two terminal blocks.</p>

General information

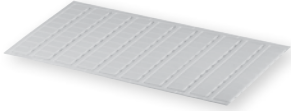
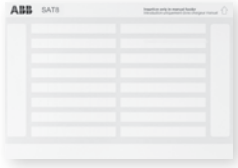
Marking solutions

Blank marker cards for industrial use	Self adhesive strips for moderate use	Universal marker holders for moderate use
		
<p>Identify your terminal blocks with blank marker cards MC... printable with ABB marking systems</p>	<p>Identify your terminal blocks with Self Adhesive sTrips SAT... printable on all desktop printers.</p>	<p>Identify your terminal blocks with Universal Marker Holders UMH compatible with most of the wire markers available on the market.</p>

Marking systems

HTP 500 Thermal Printer

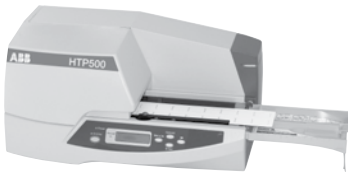

Automatic printing solutions:
AMS 500 Plotter

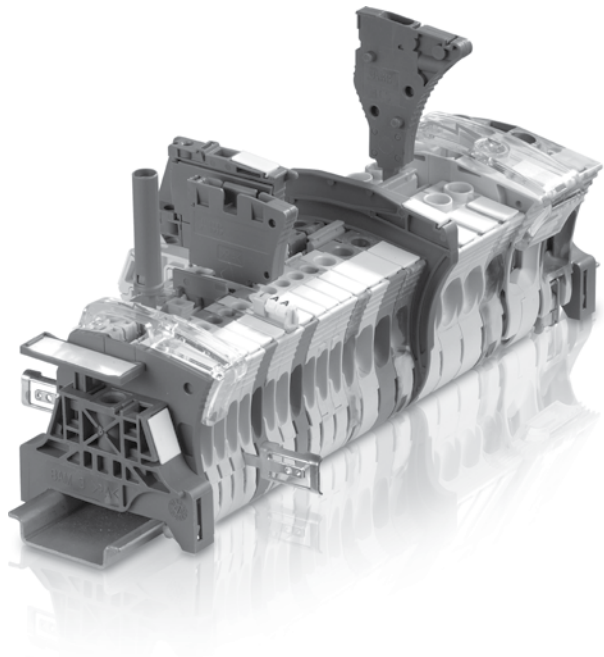
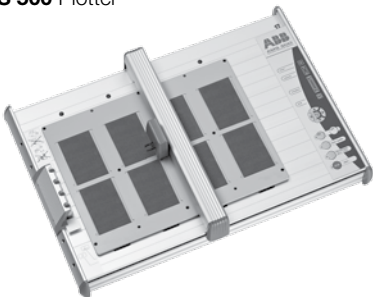

General information

Panorama

Feed-through

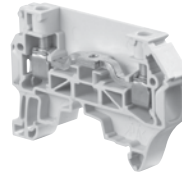
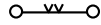

Section	
4 mm ²	12 AWG
6 mm ²	10 AWG
10 mm ²	6 AWG
16 mm ²	4 AWG
35 mm ²	0 AWG
70 mm ²	00 AWG
95 mm ²	0000 AWG

Spacing		
mm	in	
5.2	0.205	ZS4
6	0.236	ZS6
8	0.315	ZS10
10	0.394	ZS16

Spacing		
mm	in	
16	0.630	ZS35
22	0.866	ZS70
26	1.020	ZS95

Spacing		
mm	in	
8	0.315	ZS4-R1

10

Disconnect - with blade

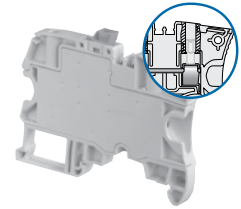
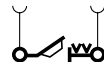
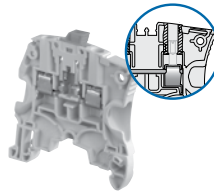
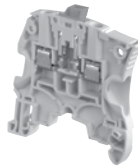

Section	
4 mm ²	10 AWG
4 mm ²	10 AWG
6 mm ²	10 AWG
10 mm ²	6 AWG

Spacing		
mm	in	
5.2	0.205	ZS4-S
6	0.236	ZS6-S
8	0.315	ZS10-S

Spacing		
mm	in	
5.2	0.205	ZS4-S-T2
5.2	0.205	ZS4-S-T2.3

Spacing		
mm	in	
6	0.236	ZS4-S-R1

Spacing		
mm	in	
6	0.236	ZS4-S-T2-R1
6	0.236	ZS4-S-T2.3-R1

For 5 x 20 mm fuses (0.197" x 0.787")

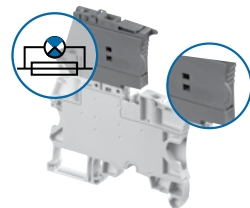
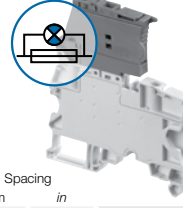
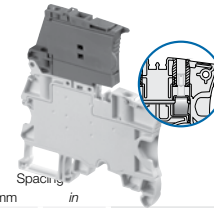
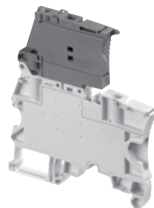

Section	
4 mm ²	10 AWG
4 mm ²	10 AWG

Spacing		
mm	in	
6	0.236	ZS4-SF

Spacing		
mm	in	
6	0.236	ZS4-SF-T2

Spacing		
mm	in	
6	0.236	ZS4-SF-R1
6	0.236	ZS4-SF-R3

Spacing		
mm	in	
6	0.236	ZS4-SF-R2
6	0.236	ZS4-SF-R4

General information Panorama

Double Deck

Ground

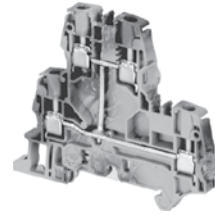
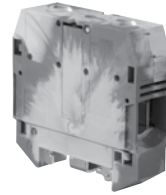
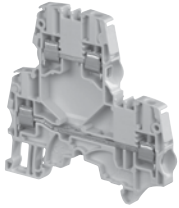
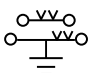
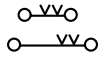

Spacing		
mm	in	
5.2	0.205	ZS4-D2
6	0.236	ZS6-D2

Spacing		
mm	in	
5.2	0.205	ZS4-D1
6	0.236	ZS6-D1

Spacing		
mm	in	
5.2	0.205	ZS4-PE
6	0.236	ZS6-PE
8	0.315	ZS10-PE
10	0.394	ZS16-PE

Spacing		
mm	in	
16	0.630	ZS35-PE
22	0.866	ZS70-PE
26	1.020	ZS95-PE

Spacing		
mm	in	
6	0.236	ZS6-D1-PE

Spacing		
mm	in	
6	0.236	ZS6-D2-PE

Disconnect - with plug

Disconnect - with lever

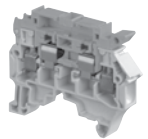
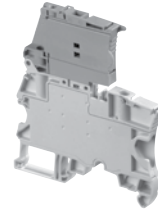
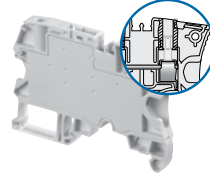
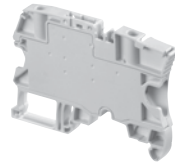
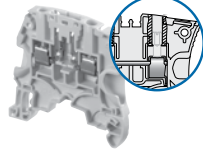
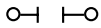

Spacing		
mm	in	
5.2	0.205	ZS4-SP
8	0.315	ZS10-SP

Spacing		
mm	in	
5.2	0.205	ZS4-SP-T2

Spacing		
mm	in	
6	0.236	ZS4-SP-R1

Spacing		
mm	in	
6	0.236	ZS4-SP-T2-R1

Spacing		
mm	in	
6	0.236	ZS4-S-R2

Spacing		
mm	in	
8	0.315	ZS4-S-R3

For 5 x 20 mm and 5 x 25 mm fuses (0.197" x .787" and 0.197" x 0.984")

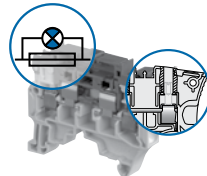
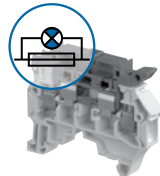
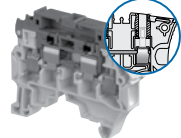
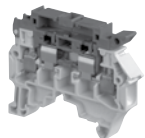

Spacing		
mm	in	
8	0.315	ZS4-SF1

Spacing		
mm	in	
8	0.315	ZS4-SF1-T2

Spacing		
mm	in	
8	0.315	ZS4-SF1-R1
8	0.315	ZS4-SF1-R3

Spacing		
mm	in	
8	0.315	ZS4-SF1-R2
8	0.315	ZS4-SF1-R4

ZS4 Screw clamp terminal blocks

Feed-through



Technical Datasheet 1SNK 161 001 D0201

5.2 mm 0.205 in spacing

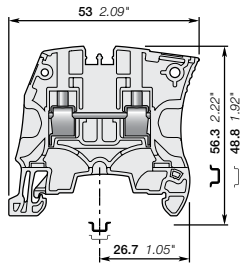
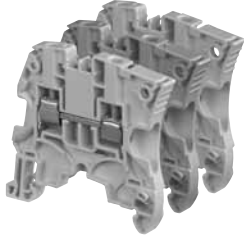

Features and Benefits

Save space by connecting conductors up to 4 mm² 12 AWG in just 5.2 mm 0.205 in spacing.

Ordering Details

Description	Color	Type	Catalog number	Packing pieces	Weight 1 pc (g)
Feed-through	Grey	ZS4	1SNK505010R0000	50	8.77
	Blue	ZS4-BL	1SNK505020R0000	50	8.77
	Orange	ZS4-OR	1SNK505030R0000	50	8.77
	Yellow	ZS4-YL	1SNK505060R0000	50	8.77
	Green	ZS4-GN	1SNK505061R0000	50	8.77
	Red	ZS4-RD	1SNK505062R0000	50	8.77
	Purple	ZS4-PR	1SNK505063R0000	50	8.77
	Brown	ZS4-BR	1SNK505064R0000	50	8.77
	White	ZS4-WH	1SNK505065R0000	50	8.77
	Black	ZS4-BK	1SNK505066R0000	50	8.77

Main Technical Data

Connecting capacity		IEC	cULus - CSA	
1 conductor per clamp	Rigid	0.2-4 mm ²	24-12 AWG	
	Flexible	0.22-4 mm ²	24-12 AWG	
		with non insulated ferrule	0.22-4 mm ²	24-12 AWG
		with insulated ferrule	0.22-2.5 mm ²	24-14 AWG
	Gauge	A3-B3		
2 conductors per clamp	Rigid	0.2-1.5 mm ²	24-16 AWG	
	Flexible	0.2-1.5 mm ²	24-16 AWG	
		with twin ferrule	0.22-1.5 mm ²	24-16 AWG
Rated cross section	4 mm ²	12 AWG		
Rated current	32 A	20 A		
Rated short-time withstand current (1s)	480 A			
Short circuit current rating (with specific conditions)		100 kA		
Rated voltage	1000 V	600 V		
Impulse withstand voltage	8000 V			
Protection	IP20	NEMA 1		

Mounting Instructions

Rail		TH 35-7.5, TH 35-15
Wire stripping length		10.5 mm 0.413 in
Tool		Flat screwdriver Ø 3.5 mm Ø 0.138 in
Torque		0.6 Nm ± 0.1 5.31 lb.in ± 0.885

Accessories

Description		Color	Type	Catalog number	Packing pieces	Weight 1 pc (g)
1 End Stops	Screw; 10mm 0.394 in	Dark Grey	BAM3	1SNK900001R0000	50	13.80
	Screwless; 5.2mm 0.205 in	Dark Grey	BAZ1	1SNK900002R0000	50	5.30
2 End Sections	2.2 mm 0.087 in	Dark Grey	ES4	1SNK505910R0000	20	2.18
	3 poles	Orange	JB5-2	1SNK905302R0000	50	1.30
3 Jumper Bars	4 poles		JB5-3	1SNK905303R0000	50	2.00
	5 poles		JB5-4	1SNK905304R0000	50	2.70
	10 poles		JB5-5	1SNK905305R0000	50	3.50
	50 poles		JB5-10	1SNK905310R0000	30	7.10
	50 poles		JB5-50	1SNK905350R0000	10	36.10
4 Cross Spacing Jumpers	8 mm 0.315 in to 5.2 mm 0.205 in spacing	Orange	JB85-3	1SNK900603R0000	10	2.80
5 Circuit Separators	0 mm 0 in	Dark Grey	CS	1SNK900101R0000	20	0.20
	3 mm 0.118 in		CS-R1	1SNK900103R0000	20	5.20
6 Test Adapters	For test plugs DIA 2 mm 0.079 in	Dark Grey	TP2	1SNK900203R0000	20	1.73
	For test plugs DIA 4 mm 0.160 in		TP4	1SNK900205R0000	20	2.42
7 Test Connectors	5.2 mm 0.205 in spacing	Dark Grey	TC5	1SNK900200R0000	10	5.23
	End module; 5.2 mm 0.205 in		TC5-R1	1SNK900201R0000	10	5.23
8 Shield Connectors			SHBS	1SNK900600R0000	20	3.50
9 Protecting Covers	5.2 mm 0.205 in spacing	Transparent	PL5	1SNK900618R0000	10	1.50
10 Terminal Block Markers	Blank card	White	MC512	1SNK140000R0000	22	9.00
	Universal wire markers holder	Grey	MC512PA	1SNK149999R0000	20	10.00
	Self adhesive strip	White	UMH	1SNK900611R0000	10	0.20
			SAT5	1SNK900614R0000	5	6.00

Some accessories may modify the terminal block's ratings. See complete information in "Technical Datasheet".

Ground Screw Clamp Terminal Blocks

Description		Color	Type	Catalog number	Packing pieces	Weight 1 pc (g)
Ground	Profile aligned with ZS4	Green-Yellow	ZS4-PE	1SNK505150R0000	20	12.10

Technical Datasheet 1SNK 161 002 D0201
Catalogue Page 1SNK 161 002 S0201



ZS6 Screw clamp terminal blocks

Feed-through



Technical Datasheet 1SNK 161 008 D0201

6 mm 0.236 in spacing

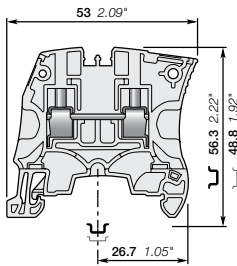
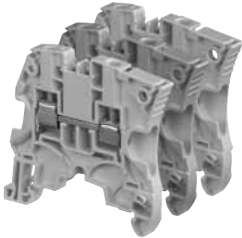

Features and Benefits

Save space by connecting conductors up to 6 mm² 10 AWG in just 6 mm 0.236 in spacing.

Ordering Details

Description	Color	Type	Catalog number	Packing pieces	Weight 1 pc (g)
Feed-through	Grey	ZS6	1SNK506010R0000	50	10.64
	Blue	ZS6-BL	1SNK506020R0000	50	10.64
	Orange	ZS6-OR	1SNK506030R0000	50	10.64
	Yellow	ZS6-YL	1SNK506060R0000	50	10.64
	Green	ZS6-GN	1SNK506061R0000	50	10.64
	Red	ZS6-RD	1SNK506062R0000	50	10.64
	Purple	ZS6-PR	1SNK506063R0000	50	10.64
	Brown	ZS6-BR	1SNK506064R0000	50	10.64
	White	ZS6-WH	1SNK506065R0000	50	10.64
	Black	ZS6-BK	1SNK506066R0000	50	10.64

Main Technical Data

Connecting capacity	IEC	cULus - CSA
1 conductor per clamp	Rigid	0.2-6 mm ² 24-10 AWG
	Flexible	0.22-6 mm ² 24-10 AWG
	with non insulated ferrule	0.22-4 mm ² 24-12 AWG
	with insulated ferrule	0.22-4 mm ² 24-12 AWG
2 conductors per clamp	Gauge	A4-B3
	Rigid	0.2-2.5 mm ² 24-14 AWG
	Flexible	0.2-2.5 mm ² 24-14 AWG
with twin ferrule		0.22-2.5 mm ² 24-14 AWG
	Rated cross section	6 mm ² 10 AWG
Rated current	41 A	30 A
Rated short-time withstand current (1s)	720 A	
Short circuit current rating (with specific conditions)		100 kA
Rated voltage	1000 V	600 V
Impulse withstand voltage	8000 V	
Protection	IP20	NEMA 1
Rated voltage Ex e	630 V IEC/EN 60079-7 IM2 II 2 GD Ex e I/II	

Mounting Instructions

Rail		TH 35-7.5, TH 35-15
Wire stripping length		10.5 mm 0.413 in
Tool		Flat screwdriver Ø 4 mm Ø 0.157 in
Torque		0.85 Nm ± 0.15 7.52 lb.in ± 1.33

10

Accessories

Description	Color	Type	Catalog number	Packing pieces	Weight 1 pc (g)	
1 End Stops	Screw; 10mm 0.394 in	BAM3	1SNK900001R0000	50	13.80	
	Screwless; 5.2mm 0.205 in	BAZ1	1SNK900002R0000	50	5.30	
2 End Sections	2.2 mm 0.087 in	ES4	1SNK505910R0000	20	2.18	
	3 Jumper Bars	2 poles 41 A 30 A	JB6-2	1SNK906302R0000	50	1.30
		3 poles	JB6-3	1SNK906303R0000	50	2.10
		4 poles	JB6-4	1SNK906304R0000	50	2.90
		5 poles	JB6-5	1SNK906305R0000	50	3.60
4 Circuit Separators	10 poles	JB6-10	1SNK906310R0000	20	7.40	
	50 poles	JB6-50	1SNK906350R0000	10	38.10	
	0 mm 0 in	CS	1SNK900101R0000	20	0.20	
5 Test Adapters	3 mm 0.118 in	CS-R1	1SNK900103R0000	20	5.20	
	For test plugs DIA 2 mm 0.079 in	TP2	1SNK900203R0000	20	1.73	
	For test plugs DIA 4 mm 0.160 in	TP4	1SNK900205R0000	20	2.42	
6 Test Connectors	End module, 5.2 mm 0.205 in	TC5-R1	1SNK900201R0000	10	5.23	
7 Spacers	0.8 mm 0.031 in spacing	ES-TC6	1SNK900105R0000	10	0.80	
8 Shield Connectors		SHBS	1SNK900600R0000	20	3.50	
9 Protecting Covers	6 mm 0.236 in spacing	PL6	1SNK900619R0000	10	1.84	
10 Terminal Block Markers	Blank card	MC612	1SNK150000R0000	22	10.00	
	Universal wire markers holder	UMH	1SNK900611R0000	10	0.20	
	Self adhesive strip	SAT6	1SNK900615R0000	5	6.00	

Some accessories may modify the terminal block's ratings. See complete information in "Technical Datasheet".

Ground Screw Clamp Terminal Blocks

Technical Datasheet 1SNK 161 002 D0201
Catalogue Page 1SNK 161 002 S0201

Description	Color	Type	Catalog number	Packing pieces	Weight 1 pc (g)
Ground Profile aligned with ZS6	Green-Yellow	ZS6-PE	1SNK506150R0000	20	13.70

ZS10 Screw clamp terminal blocks

Feed-through

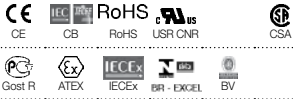

Technical Datasheet 1SNK 161 004 D0201

8 mm 0.315 in spacing

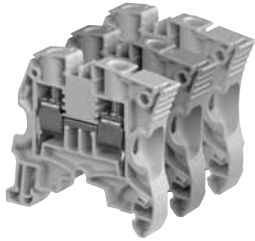

10

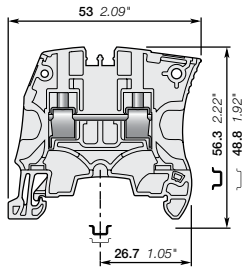

Features and Benefits

Save space by connecting conductors up to 10 mm² 6 AWG in just 8 mm 0.315 in spacing.

Ordering Details

Description	Color	Type	Catalog number	Packing pieces	Weight 1 pc (g)
Feed-through	Grey	ZS10	1SNK508010R0000	50	14.10
	Blue	ZS10-BL	1SNK508020R0000	50	14.10
	Orange	ZS10-OR	1SNK508030R0000	50	14.10
	Yellow	ZS10-YL	1SNK508060R0000	50	14.10
	Green	ZS10-GN	1SNK508061R0000	50	14.10
	Red	ZS10-RD	1SNK508062R0000	50	14.10
	Purple	ZS10-PR	1SNK508063R0000	50	14.10
	Brown	ZS10-BR	1SNK508064R0000	50	14.10
	White	ZS10-WH	1SNK508065R0000	50	14.10
	Black	ZS10-BK	1SNK508066R0000	50	14.10

Main Technical Data

Connecting capacity	IEC	cULus - CSA
1 conductor per clamp	Rigid	0.5-10 mm ² 24-6 AWG
	Flexible	0.5-10 mm ² 24-6 AWG
	with non insulated ferrule	0.5-10 mm ² 24-8 AWG
	with insulated ferrule	0.5-6 mm ² 24-8 AWG
2 conductors per clamp	Gauge	A5-B5
	Rigid	0.5-4 mm ² 20-12 AWG
	Flexible	0.5-4 mm ² 20-12 AWG
	with twin ferrule	0.5-4 mm ² 20-12 AWG
Rated cross section	10 mm ²	6 AWG
Rated current	57 A	42 A
Rated short-time withstand current (1s)	1200 A	
Short circuit current rating (with specific conditions)		100 kA
Rated voltage	1000 V	600 V
Impulse withstand voltage	8000 V	
Protection	IP20	NEMA 1
Rated voltage Ex e	630 V IEC/EN 60079-7 IM2 II 2 GD Ex e I/II	

Mounting Instructions

Rail		TH 35-7.5, TH 35-15
Wire stripping length		12 mm 0.472 in
Tool		Flat screwdriver Ø 4 mm Ø .157 in
Torque		1.3 Nm ± 0.3 11.5 lb.in ± 2.65

Accessories

Description	Color	Type	Catalog number	Packing pieces	Weight 1 pc (g)
1 End Stops	Dark Grey	Screw; 10mm 0.394 in	BAM3	1SNK900001R0000	50 13.80
		Screwless; 5.2mm 0.205 in	BAZ1	1SNK900002R0000	50 5.30
2 End Sections	Dark Grey	2.2 mm 0.087 in	ES4	1SNK505910R0000	20 2.18
		3 poles	JB8-2	1SNK908302R0000	50 2.70
3 Jumper Bars	Orange	4 poles	JB8-3	1SNK908303R0000	50 4.10
		5 poles	JB8-4	1SNK908304R0000	50 5.60
		10 poles	JB8-5	1SNK908305R0000	40 7.00
			JB8-10	1SNK908310R0000	20 14.20
			JB85-3	1SNK900603R0000	10 2.80
4 Cross Spacing Jumpers	Orange	8 mm 0.315 in to 5.2 mm 0.205 in spacing	JB85-3	1SNK900603R0000	10 2.80
5 Circuit Separators	Dark Grey	0 mm 0 in	CS	1SNK900101R0000	20 0.20
		3 mm 0.118 in	CS-R1	1SNK900103R0000	20 5.20
6 Test Adapters	Dark Grey	For test plugs DIA 2 mm 0.079 in	TP2	1SNK900203R0000	20 1.73
		For test plugs DIA 4 mm 0.160 in	TP4	1SNK900205R0000	20 2.42
7 Test Connectors	Dark Grey	5.2 mm 0.205 in spacing	TC5	1SNK900200R0000	10 5.23
		End module, 5.2 mm 0.205 in	TC5-R1	1SNK900201R0000	10 5.23
8 Spacers	Dark Grey	2.8 mm 0.110 in spacing	ES-TC8	1SNK900104R0000	10 1.35
9 Protecting Covers	Transparent	8 mm 0.315 in spacing	PL8	1SNK900620R0000	10 2.55
10 Terminal Block Markers	White	Blank card	MC812	1SNK160000R0000	22 10.00
	Grey	Universal wire markers holder	UMH	1SNK900611R0000	10 0.20
	White	Self adhesive strip	SAT8	1SNK900616R0000	5 6.00

Some accessories may modify the terminal block's ratings. See complete information in "Technical Datasheet".

Ground Screw Clamp Terminal Blocks

Description	Color	Type	Catalog number	Packing pieces	Weight 1 pc (g)
Ground Profile aligned with ZS10	Green-Yellow	ZS10-PE	1SNK508150R0000	20	22.50

Technical Datasheet 1SNK 161 002 D0201
Catalogue Page 1SNK 161 002 S0201

ZS16 Screw clamp terminal blocks

Feed-through

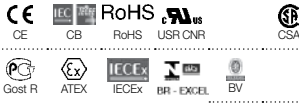

Technical Datasheet 1SNK 161 017 D0201

10 mm 0.394 in spacing

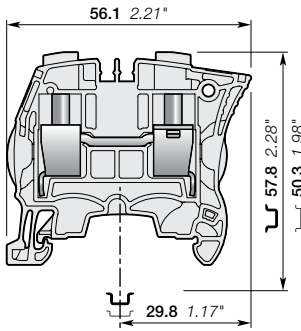

Features and Benefits

Save space by connecting conductors up to 16 mm² 4 AWG in just 10 mm 0.394 in spacing.

Ordering Details

Description	Color	Type	Catalog number	Packing pieces	Weight 1 pc (g)
Feed-through	Grey	ZS16	1SNK510010R0000	25	20.20
	Blue	ZS16-BL	1SNK510020R0000	25	20.20
	Orange	ZS16-OR	1SNK510030R0000	25	20.20

Main Technical Data

Connecting capacity	IEC	cULus - CSA
1 conductor per clamp	Rigid	0.5-16 mm ² 24-4 AWG
	Flexible	0.5-16 mm ² 24-4 AWG
	with non insulated ferrule	0.5-10 mm ² 24-8 AWG
	with insulated ferrule	0.5-10 mm ² 24-8 AWG
Gauge	A6-B6	
2 conductors per clamp	Rigid	0.5-6 mm ² 20-10 AWG
	Flexible	0.5-6 mm ² 20-10 AWG
	with twin ferrule	0.5-6 mm ² 20-10 AWG
Rated cross section	16 mm ²	4 AWG
Rated current	76 A	67 A
Rated short-time withstand current (1s)	1920 A	
Short circuit current rating (with specific conditions)		100 kA
Rated voltage	1000 V	600 V
Impulse withstand voltage	8000 V	
Protection	IP20	NEMA 1
Rated voltage Ex e	630 V IEC/EN 60079-7 IM2 II 2 GD Ex e I/II	

Mounting Instructions

Rail		TH 35-7.5, TH 35-15
Wire stripping length		13.5 mm 0.531 in
Tool		Flat screwdriver Ø 5.5 mm Ø 0.217 in
Torque		1.8 Nm ± 0.2 15.93 lb.in ± 1.77

10

Accessories

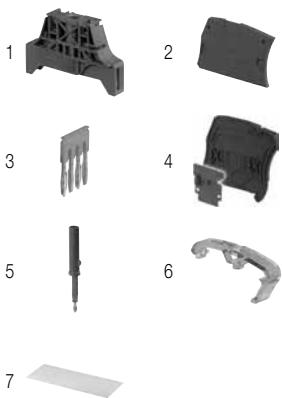

Description	Color	Type	Catalog number	Packing pieces	Weight 1 pc (g)	
1 End Stops	Dark Grey	BAM3	Screw; 10mm 0.394 in	1SNK900001R0000	50 13.80	
			Screwless; 5.2mm 0.205 in	BAZ1	1SNK900002R0000	50 5.30
2 End Sections	Dark Grey	ES4	2.2 mm 0.087 in	1SNK505910R0000	20 2.18	
			3 poles	JB10-2	1SNK910302R0000	50 4.60
3 Jumper Bars	Orange	JB10-2	2 poles 76 A 67 A	1SNK910302R0000	50 4.60	
			3 poles	JB10-3	1SNK910303R0000	50 7.10
			4 poles	JB10-4	1SNK910304R0000	40 9.40
			5 poles	JB10-5	1SNK910305R0000	30 12.00
			10 poles	JB10-10	1SNK910310R0000	20 24.00
4 Circuit Separators	Dark Grey	CS	0 mm 0 in	1SNK900101R0000	20 0.20	
			3 mm 0.118 in	CS-R1	1SNK900103R0000	20 5.20
			For test plugs DIA 2 mm 0.079 in	TP2	1SNK900203R0000	20 1.73
5 Test Adapters	Dark Grey	TP4	For test plugs DIA 4 mm 0.160 in	1SNK900205R0000	20 2.42	
			6 Protecting Covers	10 mm 0.394 in spacing	Transparent	PL10
7 Terminal Block Markers	White	MC812	Blank card	1SNK160000R0000	22 10.00	
				MC812PA	1SNK169999R0000	20 14.00
	Grey	UMH	1SNK900611R0000	10 0.20		
	White	SAT8	1SNK900616R0000	5 6.00		

Some accessories may modify the terminal block's ratings. See complete information in *Technical Datasheet*.

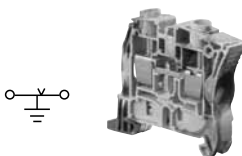

Ground Screw Clamp Terminal Blocks

Technical Datasheet 1SNK 161 002 D0201
Catalogue Page 1SNK 161 002 S0201

Description	Color	Type	Catalog number	Packing pieces	Weight 1 pc (g)
Ground	Green-Yellow	ZS16-PE	1SNK510150R0000	20	32.00

ZS35 Screw clamp terminal blocks

Feed-through



Features and Benefits

- Closed terminal block:
- No end section needed,
 - Optimized rigidity.

Ordering Details

Technical Datasheet 1SNK 161 019 D0201

16 mm 0.630 in spacing

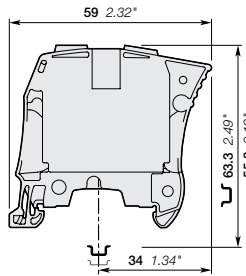

Description	Color	Type	Catalog number	Packing pieces	Weight 1 pc (g)
Feed-through Closed block	Grey	ZS35	1SNK516010R0000	20	53.40
	Blue	ZS35-BL	1SNK516020R0000	20	53.40
	Orange	ZS35-OR	1SNK516030R0000	20	53.40

Main Technical Data

Connecting capacity	IEC	cULus - CSA
1 conductor per clamp	Rigid	6-35 mm ²
	Flexible	6-35 mm ²
	with non insulated ferrule	6-35 mm ²
	with insulated ferrule	6-35 mm ²
2 conductors per clamp	Gauge	A9-B9
	Rigid	6-16 mm ²
	Flexible	6-16 mm ²
	with twin ferrule	6-10 mm ²
Rated cross section	35 mm ²	0 AWG
Rated current	125 A	150 A
Rated short-time withstand current (1s)	4200 A	
Short circuit current rating (with specific conditions)		100 kA
Rated voltage	1000 V	600 V
Impulse withstand voltage	8000 V	
Protection	IP20	NEMA 1
Rated voltage Ex e	630 V IEC/EN 60079-7 IM2 II 2 GD Ex e I/II	

Mounting Instructions

Rail		TH 35-7.5, TH 35-15
Wire stripping length		17 mm 0.669 in
Tool		Flat screwdriver Ø 6.5 mm Ø 0.256 in
Torque		2.9 Nm ± 0.1 25.7 lb.in ± 0.885

Accessories

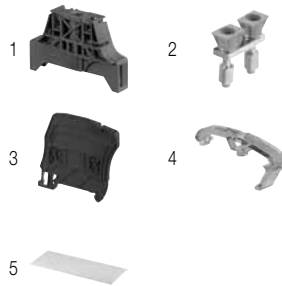

Description	Color	Type	Catalog number	Packing pieces	Weight 1 pc (g)
1 End Stops 10 mm 0.394 in	Dark Grey	BAZH1	1SNK900102R0000	20	23.90
2 Jumper Bars 2 poles 125 A 150 A	Orange	JB16-2	1SNK916302R0000	10	10.20
		JB16-3	1SNK916303R0000	10	16.00
		JB16-4	1SNK916304R0000	10	21.80
		JB16-5	1SNK916305R0000	10	27.60
		JB16-10	1SNK916310R0000	10	56.60
3 Circuit Separators 3 mm 0.118 in spacing	Dark Grey	CS-R1	1SNK900103R0000	20	5.20
4 Protecting Covers 16 mm 0.630 in spacing	Transparent	PL16	1SNK900622R0000	10	4.60
5 Terminal Block Markers	White	MC812	1SNK160000R0000	22	10.00
		MC812PA	1SNK169999R0000	20	14.00
	Universal wire markers holder	Grey	UMH	1SNK900611R0000	10
Self adhesive strip	White	SAT8	1SNK900616R0000	5	6.00

Some accessories may modify the terminal block's ratings. See complete information in "Technical Datasheet".

Ground Screw Clamp Terminal Blocks

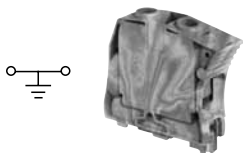

Description	Color	Type	Catalog number	Packing pieces	Weight 1 pc (g)
Ground Profile aligned with ZS35	Green-Yellow	ZS35-PE	1SNK516150R0000	20	81.80

Technical Datasheet 1SNK 161 002 D0201
Catalogue Page 1SNK 161 002 S0201

ZS70 Screw clamp terminal blocks

Feed-through

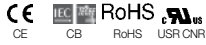

Technical Datasheet 1SNK 161 021 D0201

22 mm 0.866 in spacing

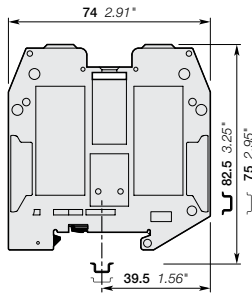

Features and Benefits

- Closed terminal block:
- No end section needed,
- Optimized rigidity.

Ordering Details

Description	Color	Type	Catalog number	Packing pieces	Weight 1 pc (g)
Feed-through Closed block	Grey	ZS70	1SNK522010R0000	10	158.10
	Blue	ZS70-BL	1SNK522020R0000	10	158.10
	Yellow	ZS70-YL	1SNK522060R0000	10	158.10

Main Technical Data

Connecting capacity	IEC	cULus - CSA
1 conductor per clamp	Rigid	16-95 mm ²
	Flexible	16-70 mm ²
	with non insulated ferrule	16-50 mm ²
	with insulated ferrule	16-50 mm ²
Gauge	B11	
2 conductors per clamp	Rigid	16-35 mm ²
	Flexible	16-35 mm ²
	with twin ferrule	16 mm ²
Rated cross section	70 mm ²	00 AWG
Rated current	192 A	159 A
Rated short-time withstand current (1s)	8400 A	
Short circuit current rating (with specific conditions)		100 kA
Rated voltage	1000 V	600 V
Impulse withstand voltage	8000 V	
Protection	IP10	NEMA 1
Rated voltage Ex e	630 V IEC/EN 60079-7 IM2 II 2 GD Ex e I/II	

Mounting Instructions

Rail		TH 35-7.5, TH 35-15
Wire stripping length		25 mm 0.984 in
Tool		Allen Key Ø 6 mm Ø 0.236 in
Torque		6.5 Nm ± 0.5 57.5 lb.in ± 4.4

10

Accessories

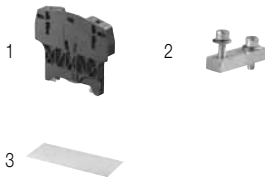

Description	Color	Type	Catalog number	Packing pieces	Weight 1 pc (g)	
1 End Stops 10 mm 0.394 in	Dark Grey	BAZH1	1SNK900102R0000	20	23.90	
2 Jumper Bars 2 poles 192 A 175 A		JB22-2	1SNK922302R0000	5	27.00	
		JB22-3	1SNK922303R0000	5	43.30	
		JB22-5	1SNK922305R0000	5	76.10	
		JB22-10	1SNK922310R0000	5	157.40	
3 Terminal Block Markers		MC812	1SNK160000R0000	22	10.00	
		MC812PA	1SNK169999R0000	20	14.00	
	Universal wire markers holder	Grey	UMH	1SNK900611R0000	10	0.20
	Self adhesive strip	White	SAT8	1SNK900616R0000	5	6.00

Some accessories may modify the terminal block's ratings. See complete information in "Technical Datasheet".

Ground Screw Clamp Terminal Blocks

Technical Datasheet 1SNK 161 002 D0201
Catalogue Page 1SNK 161 002 S0201



Description	Color	Type	Catalog number	Packing pieces	Weight 1 pc (g)
Ground Profile aligned with ZS70	Green-Yellow	ZS70-PE	1SNK522150R0000	10	222.00

ZS95 Screw clamp terminal blocks

Feed-through



Technical Datasheet 1SNK 161 023 D0201

26 mm 1.02 in spacing

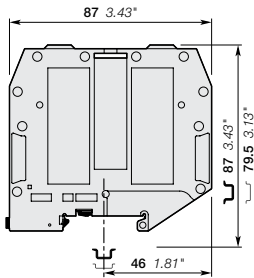

Features and Benefits

- Closed terminal block:
- No end section needed,
- Optimized rigidity.

Ordering Details

Description	Color	Type	Catalog number	Packing pieces	Weight 1 pc (g)
Feed-through Closed block	Grey	ZS95	1SNK526010R0000	10	215.10
	Blue	ZS95-BL	1SNK526020R0000	10	215.10
	Yellow	ZS95-YL	1SNK526060R0000	10	215.10

Main Technical Data

Connecting capacity	IEC	cULus - CSA
1 conductor per clamp	Rigid	35-120 mm ²
	Flexible	35-95 mm ² 2-0000 AWG
	with non insulated ferrule	35-50 mm ²
with insulated ferrule	35-50 mm ²	
2 conductors per clamp	Gauge	B12
	Rigid	25-35 mm ² 4-2 AWG
	Flexible	25-35 mm ² 4-2 AWG
with twin ferrule	16 mm ²	
Rated cross section	95 mm ²	0000 AWG
Rated current	232 A	230 A
Rated short-time withstand current (1s)	11400 A	
Short circuit current rating (with specific conditions)		100 kA
Rated voltage	1000 V	600 V
Impulse withstand voltage	8000 V	
Protection	IP10	NEMA 1
Rated voltage Ex e	630 V IEC/EN 60079-7 IM2 II 2 GD Ex e I/II	

Mounting Instructions

Rail		TH 35-7.5, TH 35-15
Wire stripping length		26 mm 1.023 in
Tool		Allen Key Ø 6 mm Ø 0.236 in
Torque		9.25 Nm ± 0.25 81.7 lb.in ± 2.2

10

Accessories

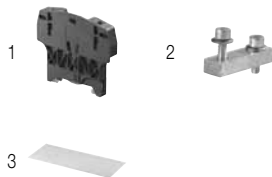

Description	Color	Type	Catalog number	Packing pieces	Weight 1 pc (g)	
1 End Stops 10 mm 0.394 in	Dark Grey	BAZH1	1SNK900102R0000	20	23.90	
2 Jumper Bars		2 poles 232 A 230 A	JB26-2	1SNK926302R0000	5	41.20
		3 poles	JB26-3	1SNK926303R0000	5	65.70
		5 poles	JB26-5	1SNK926305R0000	5	115.70
		10 poles	JB26-10	1SNK926310R0000	5	241.50
3 Terminal Block Markers	White	Blank card	MC812	1SNK160000R0000	22	10.00
			MC812PA	1SNK169999R0000	20	14.00
	Universal wire markers holder	Grey	UMH	1SNK900611R0000	10	0.20
Self adhesive strip	White	SAT8	1SNK900616R0000	5	6.00	

Some accessories may modify the terminal block's ratings. See complete information in "Technical Datasheet".

Ground Screw Clamp Terminal Blocks

Technical Datasheet 1SNK 161 002 D0201
Catalogue Page 1SNK 161 002 S0201

Description	Color	Type	Catalog number	Packing pieces	Weight 1 pc (g)
Ground Profile aligned with ZS95	Green-Yellow	ZS95-PE	1SNK526150R0000	10	278.00



ZS4-R1 Screw clamp terminal blocks

Feed-through



Technical Datasheet 1SNK 161 009 D0201

8 mm 0.315 in spacing

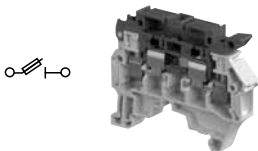
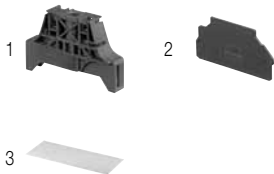
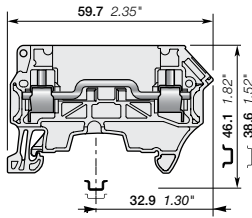

Features and Benefits

Simplify the alternated feed-through and fuse circuits operations:

- With the same profile as the ZS4-SF1, the wiring of the alternated feed-through and fuse circuits is easier.

Ordering Details

Description	Color	Type	Catalog number	Packing pieces	Weight 1 pc (g)
Feed-through Profile aligned with ZS4-SF1	Grey	ZS4-R1	1SNK508013R0000	50	11.00

Main Technical Data

Connecting capacity	IEC	cULus - CSA
1 conductor per clamp	Rigid	0.2-4 mm ²
	Flexible	0.22-4 mm ²
	with non insulated ferrule	0.22-4 mm ²
	with insulated ferrule	0.22-4 mm ²
	Gauge	A3-B3
2 conductors per clamp	Rigid	0.2-1.5 mm ²
	Flexible	0.2-1.5 mm ²
	with twin ferrule	0.22-1.5 mm ²
Maximum cross section	4 mm ²	10 AWG
Max. current / Max. cross section	28 A	26 A
Rated short-time withstand current (1s)	480 A	
Rated voltage	800 V	300 V
Impulse withstand voltage	8000 V	
Protection	IP20	NEMA 1
Rated voltage Ex e	IEC/EN 60079-7	

Mounting Instructions

Rail		TH 35-7.5, TH 35-15
Wire stripping length		11 mm 0.433 in
Tool		Flat screwdriver Ø 3.5 mm Ø 0.138 in
Torque		0.6 Nm ± 0.1 5.31 lb.in ± 0.885

10

Accessories

Description	Color	Type	Catalog number	Packing pieces	Weight 1 pc (g)
1 End Stops	Screw; 10mm 0.394 in	BAM3	1SNK900001R0000	50	13.80
	Screwless; 5.2mm 0.205 in	BAZ1	1SNK900002R0000	50	5.30
2 End Sections	1.5 mm 0.059 in	ES4-SF	1SNK508960R0000	20	1.82
3 Terminal Block Markers	Blank card	MC812	1SNK160000R0000	22	10.00
	Universal wire markers holder	MC812PA	1SNK169999R0000	20	14.00
	Self adhesive strip	UMH	1SNK900611R0000	10	0.20
		SAT8	1SNK900616R0000	5	6.00

Some accessories may modify the terminal block's ratings. See complete information in "Technical Datasheet".

Fuse Screw Clamp Terminal Blocks

Description	Color	Type	Catalog number	Packing pieces	Weight 1 pc (g)
	Grey-Dark Grey	ZS4-SF1	1SNK508410R0000	50	13.30

Technical Datasheet 1SNK 161 002 D0201
Catalogue Page 1SNK 161 002 S0201

ZS4-D2 Screw clamp terminal blocks

Double deck with 2 feed-through circuits

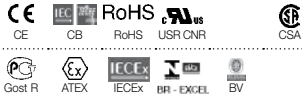

Technical Datasheet 1SNK 161 003 D0201

5.2 mm 0.205 in spacing



10

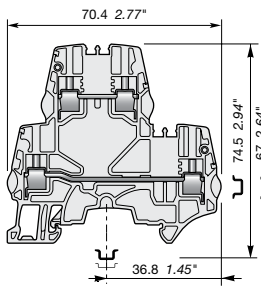

Features and Benefits

- Save space with double deck terminal blocks: 2 independent circuits connected in just 5.2 mm 0.205 in spacing ;
- Customize yourself the double deck terminal blocks by soldering electronic components (up to 8.8 mm x 3.2 mm 0.346 in x 0.125 in) in the existing linking bars punching.

Ordering Details

Description	Color	Type	Catalog number	Packing pieces	Weight 1 pc (g)
Double deck 2 Feed-through Circuits	Grey	ZS4-D2	1SNK505210R0000	50	15.25
	Blue	ZS4-D2-BL	1SNK505220R0000	50	15.25
	Orange	ZS4-D2-OR	1SNK505230R0000	50	15.25

Main Technical Data

Connecting capacity	IEC	cULus - CSA
1 conductor per clamp	Rigid	0.2-4 mm ²
	Flexible	0.22-4 mm ²
	with non insulated ferrule	0.22-4 mm ²
	with insulated ferrule	0.22-2.5 mm ²
	Gauge	A3-B3
2 conductors per clamp	Rigid	0.2-1.5 mm ²
	Flexible	0.2-1.5 mm ²
	with twin ferrule	0.22-1.5 mm ²
Rated cross section	4 mm ²	12 AWG
Rated current	29 A	20 A
Rated short-time withstand current (1s)	480 A	
Short circuit current rating (with specific conditions)		100 kA
Rated voltage	800 V	300 V
Impulse withstand voltage	8000 V	
Protection	IP20	NEMA 1
Rated voltage Ex e	400 V IEC/EN 60079-7 IM2 II 2 GD Ex e I/II	

Mounting Instructions

Rail		TH 35-7.5, TH 35-15
Wire stripping length		10 mm 0.394 in
Tool		Flat screwdriver Ø 3.5 mm Ø 0.138 in
Torque		0.6 Nm ± 0.1 5.31 lb.in ± 0.885

Accessories

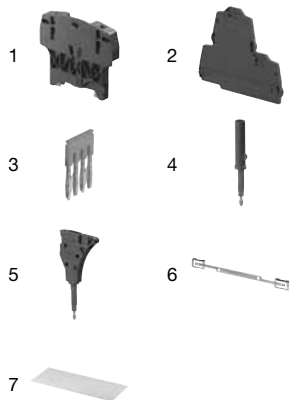

Description	Color	Type	Catalog number	Packing pieces	Weight 1 pc (g)
1 End Stops 10 mm 0.394 in	Dark Grey	BAZH1	1SNK900102R0000	20	23.90
2 End Sections 2.55 mm 0.100 in	Dark Grey	ES4-D2	1SNK505960R0000	20	4.10
3 Jumper Bars 2 poles 32 A 30 A	Orange	JB5-2	1SNK905302R0000	50	1.30
		JB5-3	1SNK905303R0000	50	2.00
		JB5-4	1SNK905304R0000	50	2.70
		JB5-5	1SNK905305R0000	50	3.50
		JB5-10	1SNK905310R0000	30	7.10
4 Test Adapters For test plugs DIA 2 mm 0.079 in	Dark Grey	TP2	1SNK900203R0000	20	1.73
		TP4	1SNK900205R0000	20	2.42
5 Test Connectors 5.2 mm 0.205 in spacing	Dark Grey	TC5	1SNK900200R0000	10	5.23
		TC5-R1	1SNK900201R0000	10	5.23
6 Shield Connectors	Dark Grey	SHB	1SNK900602R0000	20	4.90
		MC512	1SNK140000R0000	22	9.00
7 Terminal Block Markers	White	MC512PA	1SNK149999R0000	20	10.00
		UMH	1SNK900611R0000	10	0.20
		SAT5	1SNK900614R0000	5	6.00

Some accessories may modify the terminal block's ratings. See complete information in "Technical Datasheet".

ZS4-D1 Screw clamp terminal blocks

Double deck with 1 feed-through circuit



Technical Datasheet 1SNK 161 007 D0201

5.2 mm 0.205 in spacing

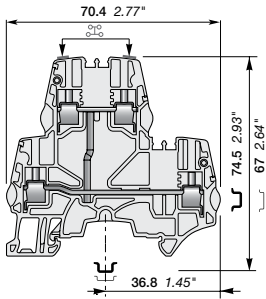

Features and Benefits

- Ease one potential distribution on 4 independent screw clamps,
- Save space by connecting conductors up to 4 mm² 12 AWG in just 5.2 mm 0.205 in spacing.

Ordering Details

Description	Color	Type	Catalog number	Packing pieces	Weight 1 pc (g)
Double deck 1 Feed-through Circuit	Grey	ZS4-D1	1SNK505211R0000	50	15.25

Main Technical Data

Connecting capacity	IEC	cULus - CSA
1 conductor per clamp	Rigid	0.2-4 mm ² 24-12 AWG
	Flexible	0.22-4 mm ² 24-12 AWG
	with non insulated ferrule	0.22-4 mm ² 24-12 AWG
	with insulated ferrule	0.22-2.5 mm ² 24-14 AWG
Gauge	A3-B3	
2 conductors per clamp	Rigid	0.2-1.5 mm ² 24-16 AWG
	Flexible	0.2-1.5 mm ² 24-16 AWG
	with twin ferrule	0.22-1.5 mm ² 24-16 AWG
Rated cross section	4 mm ²	12 AWG
Rated current	29 A	20 A
Rated short-time withstand current (1s)	480 A	
Short circuit current rating (with specific conditions)		100 kA
Rated voltage	800 V	300 V
Impulse withstand voltage	8000 V	
Protection	IP20	NEMA 1
Rated voltage Ex e	400 V IEC/EN 60079-7 IM2 II 2 GD Ex e I/II	

Mounting Instructions

Rail		TH 35-7.5, TH 35-15
Wire stripping length		10 mm 0.394 in
Tool		Flat screwdriver Ø 3.5 mm Ø 0.138 in
Torque		0.6 Nm ± 0.1 5.31 lb.in ± 0.885

10

Accessories

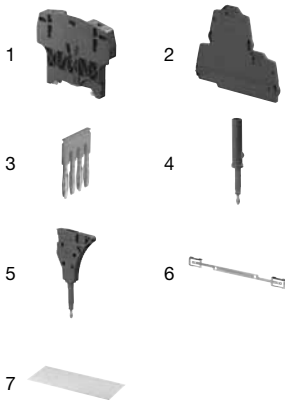

Description	Color	Type	Catalog number	Packing pieces	Weight 1 pc (g)
1 End Stops 10 mm 0.394 in	Dark Grey	BAZH1	1SNK900102R0000	20	23.90
2 End Sections 2.55 mm 0.100 in	Dark Grey	ES4-D2	1SNK505960R0000	20	4.10
3 Jumper Bars 2 poles 32 A 30 A	Orange	JB5-2	1SNK905302R0000	50	1.30
		JB5-3	1SNK905303R0000	50	2.00
		JB5-4	1SNK905304R0000	50	2.70
		JB5-5	1SNK905305R0000	50	3.50
		JB5-10	1SNK905310R0000	30	7.10
4 Test Adapters For test plugs DIA 2 mm 0.079 in For test plugs DIA 4 mm 0.160 in	Dark Grey	TP2	1SNK900203R0000	20	1.73
		TP4	1SNK900205R0000	20	2.42
5 Test Connectors 5.2 mm 0.205 in spacing End module, 5.2 mm 0.205 in	Dark Grey	TC5	1SNK900200R0000	10	5.23
		TC5-R1	1SNK900201R0000	10	5.23
		SHB	1SNK900602R0000	20	4.90
6 Shield Connectors	White	MC512	1SNK140000R0000	22	9.00
		MC512PA	1SNK149999R0000	20	10.00
		UMH	1SNK900611R0000	10	0.20
7 Terminal Block Markers Universal wire markers holder Self adhesive strip	Grey	SAT5	1SNK900614R0000	5	6.00

Some accessories may modify the terminal block's ratings. See complete information in "Technical Datasheet".

ZS6-D2 Screw clamp terminal blocks

Double deck with 2 feed-through circuits



Technical Datasheet 1SNK 161 014 D0201

6 mm 0.236 in spacing

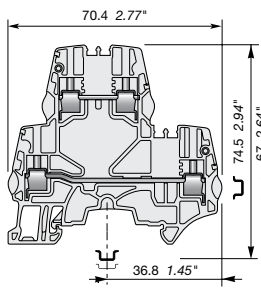

Features and Benefits

- Save space with double deck terminal blocks: 2 independent circuits connected in 6 mm 0.236 in spacing ;
- Customize yourself the double deck terminal blocks by soldering electronic components (up to 8.8 mm x 3.2 mm 0.346 in x 0.125 in) in the existing linking bars punching.

Ordering Details

Description	Color	Type	Catalog number	Packing pieces	Weight 1 pc (g)
Double deck 2 Feed-through Circuits	Grey	ZS6-D2	1SNK506210R0000	50	18.41
	Blue	ZS6-D2-BL	1SNK506220R0000	50	18.41
	Orange	ZS6-D2-OR	1SNK506230R0000	50	18.41

Main Technical Data

Connecting capacity	IEC	cULus - CSA
1 conductor per clamp	Rigid	0.2-6 mm ² 24-10 AWG
	Flexible	0.22-6 mm ² 24-10 AWG
	with non insulated ferrule	0.22-4 mm ² 24-12 AWG
	with insulated ferrule	0.22-4 mm ² 24-12 AWG
Gauge	A4-B3	
2 conductors per clamp	Rigid	0.2-2.5 mm ² 24-14 AWG
	Flexible	0.2-2.5 mm ² 24-14 AWG
	with twin ferrule	0.22-2.5 mm ² 24-14 AWG
Rated cross section	6 mm ²	10 AWG
Rated current	41 A	30 A
Rated short-time withstand current (1s)	720 A	
Short circuit current rating (with specific conditions)		100 kA
Rated voltage	800 V	300 V
Impulse withstand voltage	8000 V	
Protection	IP20	NEMA 1
Rated voltage Ex e	400 V IEC/EN 60079-7 IM2 II 2 GD Ex e I/II	

Mounting Instructions

Rail		TH 35-7.5, TH 35-15
Wire stripping length		10 mm 0.394 in
Tool		Flat screwdriver Ø 4 mm Ø 0.157 in
Torque		0.85 Nm ± 0.15 7.52 lb.in ± 1.33

Accessories

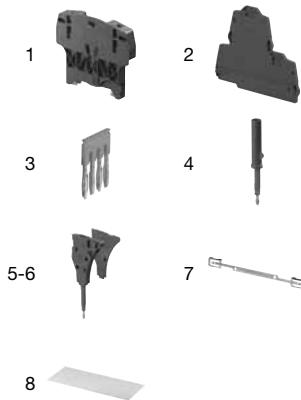

Description	Color	Type	Catalog number	Packing pieces	Weight 1 pc (g)
1 End Stops 10 mm 0.394 in	Dark Grey	BAZH1	1SNK900102R0000	20	23.90
2 End Sections 2.55 mm 0.100 in	Dark Grey	ES4-D2	1SNK505960R0000	20	4.10
3 Jumper Bars 2 poles 41 A 30 A	Orange	JB6-2	1SNK906302R0000	50	1.30
		JB6-3	1SNK906303R0000	50	2.10
		JB6-4	1SNK906304R0000	50	2.90
		JB6-5	1SNK906305R0000	50	3.60
		JB6-10	1SNK906310R0000	20	7.40
4 Test Adapters For test plugs DIA 2 mm 0.079 in	Dark Grey	TP2	1SNK900203R0000	20	1.73
		TP4	1SNK900205R0000	20	2.42
5 Test Connectors End module, 5.2 mm 0.205 in	Dark Grey	TC5-R1	1SNK900201R0000	10	5.23
6 Spacers 0.8 mm 0.031 in spacing	Dark Grey	ES-TC6	1SNK900105R0000	10	0.80
7 Shield Connectors		SHB	1SNK900602R0000	20	4.90
8 Terminal Block Markers	White	MC612	1SNK150000R0000	22	10.00
		MC612PA	1SNK159999R0000	20	11.00
	Universal wire markers holder	Grey	UMH	1SNK900611R0000	10
Self adhesive strip	White	SAT6	1SNK900615R0000	5	6.00

Some accessories may modify the terminal block's ratings. See complete information in "Technical Datasheet".

ZS6-D1 Screw clamp terminal blocks

Double deck with 1 feed-through circuit

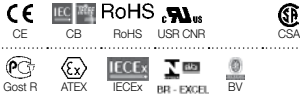

Features and Benefits

- Ease one potential distribution on 4 independent screw clamps,
- Save space by connecting conductors up to 6 mm² 10 AWG in just 6 mm 0.236 in spacing.

Ordering Details

Description		Color	Type	Catalog number	Packing pieces	Weight 1 pc (g)
Double deck 1 Feed-through Circuit		Grey	ZS6-D1	1SNK506211R0000	50	18.41

6 mm 0.236 in spacing

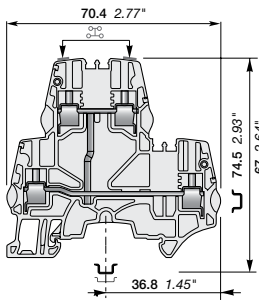

Main Technical Data

Connecting capacity		IEC	cULus - CSA
1 conductor per clamp	Rigid	0.2-6 mm ²	24-10 AWG
	Flexible	0.22-6 mm ²	24-10 AWG
	with non insulated ferrule	0.22-4 mm ²	24-12 AWG
	with insulated ferrule	0.22-4 mm ²	24-12 AWG
Gauge		A4-B3	
2 conductors per clamp	Rigid	0.2-2.5 mm ²	24-14 AWG
	Flexible	0.2-2.5 mm ²	24-14 AWG
	with twin ferrule	0.22-2.5 mm ²	24-14 AWG
Rated cross section		6 mm ²	10 AWG
Rated current		41 A	30 A
Rated short-time withstand current (1s)		720 A	
Short circuit current rating (with specific conditions)			100 kA
Rated voltage		800 V	300 V
Impulse withstand voltage		8000 V	
Protection		IP20	NEMA 1
Rated voltage Ex e		400 V IEC/EN 60079-7 IM2 II 2 GD Ex e I/II	

Mounting Instructions

Rail		TH 35-7.5, TH 35-15
Wire stripping length		10 mm 0.394 in
Tool		Flat screwdriver Ø 4 mm Ø 0.157 in
Torque		0.85 Nm ± 0.15 7.52 lb.in ± 1.33

10

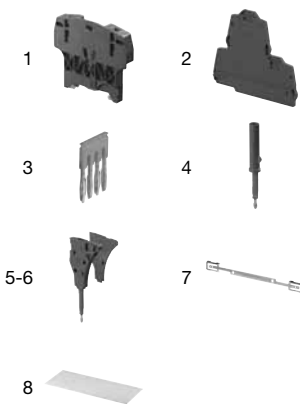

Accessories

Description		Color	Type	Catalog number	Packing pieces	Weight 1 pc (g)
1	End Stops 10 mm 0.394 in	Dark Grey	BAZH1	1SNK900102R0000	20	23.90
2	End Sections 2.55 mm 0.100 in	Dark Grey	ES4-D2	1SNK505960R0000	20	4.10
3	Jumper Bars 2 poles 41 A 30 A	Orange	JB6-2	1SNK906302R0000	50	1.30
	3 poles		JB6-3	1SNK906303R0000	50	2.10
	4 poles		JB6-4	1SNK906304R0000	50	2.90
	5 poles		JB6-5	1SNK906305R0000	50	3.60
	10 poles		JB6-10	1SNK906310R0000	20	7.40
4	Test Adapters For test plugs DIA 2 mm 0.079 in	Dark Grey	TP2	1SNK900203R0000	20	1.73
	For test plugs DIA 4 mm 0.160 in		TP4	1SNK900205R0000	20	2.42
5	Test Connectors End module, 5.2 mm 0.205 in	Dark Grey	TC5-R1	1SNK900201R0000	10	5.23
6	Spacers 0.8 mm 0.031 in spacing	Dark Grey	ES-TC6	1SNK900105R0000	10	0.80
7	Shield Connectors		SHB	1SNK900602R0000	20	4.90
8	Terminal Block Markers	White	MC612	1SNK150000R0000	22	10.00
	Universal wire markers holder	Grey	UMH	1SNK900611R0000	10	0.20
	Self adhesive strip	White	SAT6	1SNK900615R0000	5	6.00

Some accessories may modify the terminal block's ratings. See complete information in "Technical Datasheet".

ZS4-PE Screw clamp terminal blocks

Ground



Technical Datasheet 1SNK 161 002 D0201

5.2 mm 0.205 in spacing

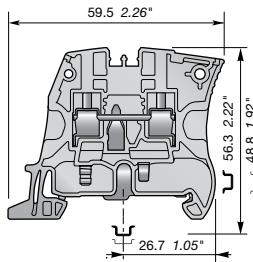

Features and Benefits

Improve the safety of your installation in the event of a short-circuit thanks to our screwless rail contact:

- Rail contact non operator dependent,
- Performances above the requirements of IEC 60947-7-2 terminal block standard,
- Secured snap on or remove from the rail.

Ordering Details

Description	Color	Type	Catalog number	Packing pieces	Weight 1 pc (g)
Ground Screwless rail connection	Green-Yellow	ZS4-PE	1SNK505150R0000	20	12.10

Main Technical Data

Connecting capacity	IEC	cULus - CSA
1 conductor per clamp	Rigid	0.2-4 mm ²
	Flexible	0.22-4 mm ²
	with non insulated ferrule	0.22-4 mm ²
	with insulated ferrule	0.22-2.5 mm ²
Gauge	A3-B3	
Rated cross section	4 mm ²	12 AWG
Rated short-time withstand current (1s)	480 A	396 A
Protection	IP20	NEMA 1
Explosive atmosphere classification	IM2 II 2 GD Ex e I/II	

Mounting Instructions

Rail		TH 35-7.5, TH 35-15
Wire stripping length		10.5 mm 0.413 in
Tool		Flat screwdriver Ø 3.5 mm Ø 0.138 in
Torque		0.6 Nm ± 0.1 5.31 lb.in ± 0.885

Accessories

Description	Color	Type	Catalog number	Packing pieces	Weight 1 pc (g)	
1 End Stops	Screw; 10mm 0.394 in	BAM3	1SNK900001R0000	50	13.80	
	Screwless; 5.2mm 0.205 in	BAZ1	1SNK900002R0000	50	5.30	
2 End Sections	2.2 mm 0.087 in	ES4	1SNK505910R0000	20	2.18	
3 Circuit Separators	3 mm 0.118 in	CS-R1	1SNK900103R0000	20	5.20	
4 Terminal Block Markers	Blank card	MC512	1SNK140000R0000	22	9.00	
		MC512PA	1SNK149999R0000	20	10.00	
	Universal wire markers holder	Grey	UMH	1SNK900611R0000	10	0.20
	Self adhesive strip	White	SAT5	1SNK900614R0000	5	6.00

Some accessories may modify the terminal block's ratings. See complete information in "Technical Datasheet".

ZS6-PE Screw clamp terminal blocks

Ground



Technical Datasheet 1SNK 161 015 D0201

6 mm 0.236 in spacing

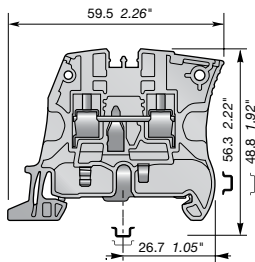
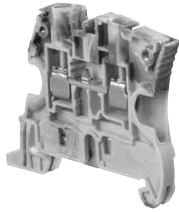

Features and Benefits

Improve the safety of your installation in the event of a short-circuit thanks to our screwless rail contact:

- Rail contact non operator dependent,
- Performances above the requirements of IEC 60947-7-2 terminal block standard,
- Secured snap on or remove from the rail.

Ordering Details

Description	Color	Type	Catalog number	Packing pieces	Weight 1 pc (g)
Ground Screwless rail connection	Green-Yellow	ZS6-PE	1SNK506150R0000	20	13.70

Main Technical Data

Connecting capacity	IEC	cULus - CSA
1 conductor per clamp	Rigid	0.2-6 mm ²
	Flexible	0.22-6 mm ²
	with non insulated ferrule	0.22-4 mm ²
	with insulated ferrule	0.22-4 mm ²
Gauge	A4-B3	
Rated cross section	6 mm ²	10 AWG
Rated short-time withstand current (1s)	720 A	636 A
Protection	IP20	NEMA 1
Explosive atmosphere classification	IM2 II 2 GD Ex e I/II	

Mounting Instructions

Rail		TH 35-7.5, TH 35-15
Wire stripping length		10.5 mm 0.413 in
Tool		Flat screwdriver Ø 4 mm Ø 0.157 in
Torque		0.85 Nm ± 0.15 7.52 lb.in ± 1.33

10

Accessories

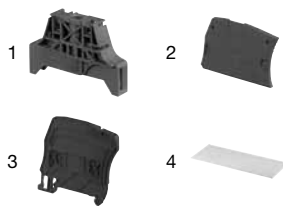

Description	Color	Type	Catalog number	Packing pieces	Weight 1 pc (g)
1 End Stops	Dark Grey	BAM3	1SNK900001R0000	50	13.80
	Dark Grey	BAZ1	1SNK900002R0000	50	5.30
2 End Sections	Dark Grey	ES4	1SNK505910R0000	20	2.18
3 Circuit Separators	Dark Grey	CS-R1	1SNK900103R0000	20	5.20
4 Terminal Block Markers	White	MC612	1SNK150000R0000	22	10.00
	White	MC612PA	1SNK159999R0000	20	11.00
	Grey	UMH	1SNK900611R0000	10	0.20
Self adhesive strip	White	SAT6	1SNK900615R0000	5	6.00

Some accessories may modify the terminal block's ratings. See complete information in "Technical Datasheet".

ZS10-PE Screw clamp terminal blocks

Ground

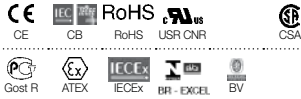

Technical Datasheet 1SNK 161 016 D0201

8 mm 0.315 in spacing

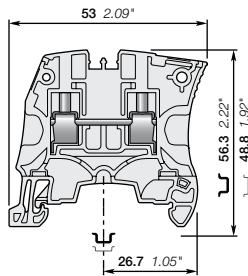

Features and Benefits

Improve the safety of your installation in the event of a short-circuit thanks to our screwless rail contact:

- Rail contact non operator dependent,
- Performances above the requirements of IEC 60947-7-2 terminal block standard,
- Secured snap on or remove from the rail,
- PE.N function available by combining ZS10-PE with ZS10-BL and 2 poles jumper bar JB8-2.

Ordering Details

Description	Color	Type	Catalog number	Packing pieces	Weight 1 pc (g)
Ground Screwless rail connection	Green-Yellow	ZS10-PE	1SNK508150R0000	20	22.50

Main Technical Data

Connecting capacity	IEC	cULus - CSA
1 conductor per clamp	Rigid	0.5-10 mm ²
	Flexible	0.5-10 mm ²
	with non insulated ferrule	0.5-10 mm ²
	with insulated ferrule	0.5-6 mm ²
Gauge	A5-B5	
Rated cross section	10 mm ²	6 AWG
Rated short-time withstand current (1s)	1200 A	1596 A
Protection	IP20	NEMA 1
Explosive atmosphere classification	IM2 II 2 GD Ex e I/II	

Mounting Instructions

Rail		TH 35-15
Wire stripping length		12 mm 0.472 in
Tool		Flat screwdriver Ø 4 mm Ø 0.157 in
Torque		1.3 Nm ± 0.3 11.5 lb.in ± 2.65

Accessories

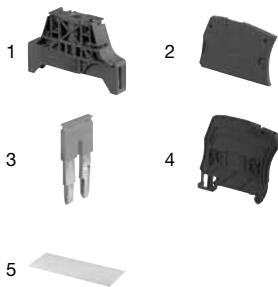

Description	Color	Type	Catalog number	Packing pieces	Weight 1 pc (g)
1 End Stops	Dark Grey	BAM3	1SNK900001R0000	50	13.80
			Screwless; 5.2mm 0.205 in	BAZ1	1SNK900002R0000
2 End Sections	Dark Grey	ES4	1SNK505910R0000	20	2.18
3 Jumper Bars	Orange	JB8-2	1SNK908302R0000	50	2.70
4 Circuit Separators	Dark Grey	CS-R1	1SNK900103R0000	20	5.20
5 Terminal Block Markers	White	MC812	1SNK160000R0000	22	10.00
			MC812PA	1SNK169999R0000	20
		Universal wire markers holder	Grey	UMH	1SNK900611R0000
Self adhesive strip	White	SAT8	1SNK900616R0000	5	6.00

Some accessories may modify the terminal block's ratings. See complete information in "Technical Datasheet".

ZS16-PE Screw clamp terminal blocks

Ground



Technical Datasheet 1SNK 161 018 D0201

10 mm 0.394 in spacing

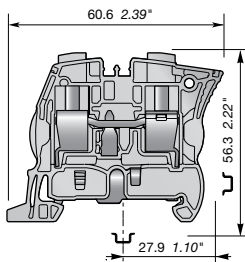
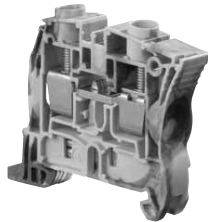

Features and Benefits

Improve the safety of your installation in the event of a short-circuit thanks to our screwless rail contact:

- Rail contact non operator dependent,
- Performances above the requirements of IEC 60947-7-2 terminal block standard,
- Secured snap on or remove from the rail,
- PE.N function available by combining ZS16-PE with ZS16-BL and 2 poles jumper bar JB10-2.

Ordering Details

Description	Color	Type	Catalog number	Packing pieces	Weight 1 pc (g)
Ground Screwless rail connection	Green-Yellow	ZS16-PE	1SNK510150R0000	20	32.00

Main Technical Data

Connecting capacity	IEC	cULus - CSA
1 conductor per clamp	Rigid	0.5-16 mm ² 24-4 AWG
	Flexible	0.5-16 mm ² 24-4 AWG
	with non insulated ferrule	0.5-10 mm ² 24-8 AWG
	with insulated ferrule	0.5-10 mm ² 24-8 AWG
Gauge	A6-B6	
Rated cross section	16 mm ²	4 AWG
Rated short-time withstand current (1s)	1920 A	2544 A
Protection	IP20	NEMA 1
Explosive atmosphere classification	IM2 II 2 GD Ex e I/II	

Mounting Instructions

Rail		TH 35-15
Wire stripping length		13.5 mm 0.531 in
Tool		Flat screwdriver Ø 5.5 mm Ø 0.217 in
Torque		1.8 Nm ± 0.2 15.93 lb.in ± 1.77

10

Accessories

Description	Color	Type	Catalog number	Packing pieces	Weight 1 pc (g)	
1 End Stops	Screw; 10mm 0.394 in	Dark Grey	BAM3	1SNK900001R0000	50	13.80
	Screwless; 5,2mm 0.205 in	Dark Grey	BAZ1	1SNK900002R0000	50	5.30
2 End Sections	2.2 mm 0.087 in	Dark Grey	ES4	1SNK505910R0000	20	2.18
3 Jumper Bars	2 poles 76 A 67 A	Orange	JB10-2	1SNK910302R0000	50	4.60
4 Circuit Separators	3 mm 0.118 in	Dark Grey	CS-R1	1SNK900103R0000	20	5.20
5 Terminal Block Markers	Blank card	White	MC812	1SNK160000R0000	22	10.00
	Universal wire markers holder	Grey	UMH	1SNK900611R0000	10	0.20
	Self adhesive strip	White	SAT8	1SNK900616R0000	5	6.00

Some accessories may modify the terminal block's ratings. See complete information in "Technical Datasheet".

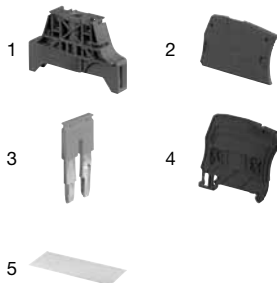

ZS35-PE Screw clamp terminal blocks

Ground



Technical Datasheet 1SNK 161 020 D0201

16 mm 0.630 in spacing

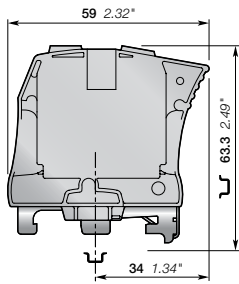

10

Features and Benefits

Reliable electrical and mechanical contact with the rail that exceeds the requirements of IEC 60947-7-2 terminal block standard.

Ordering Details

Description	Color	Type	Catalog number	Packing pieces	Weight 1 pc (g)
Ground Screw rail connection	Green-Yellow	ZS35-PE	1SNK516150R0000	20	81.80

Main Technical Data

Connecting capacity	IEC	cULus - CSA
1 conductor per clamp	Rigid	6-35 mm ²
	Flexible	6-35 mm ²
	with non insulated ferrule	6-35 mm ²
	with insulated ferrule	6-35 mm ²
Gauge	A9	
Rated cross section	35 mm ²	2 AWG
Rated short-time withstand current (1s)	4200 A	4032 A
Protection	IP20	NEMA 1
Explosive atmosphere classification	IM2 II 2 GD Ex e I/II	

Mounting Instructions

Rail		TH 35-15
Wire stripping length		17 mm 0.669 in
Tool		Flat screwdriver
Screw clamp		Ø 6.5 mm Ø 0.256 in
Rail connection screw		Ø 5.5 mm Ø 0.217 in
Torque		2.65 Nm ± 0.15 23.5 lb.in ± 1.33
Screw clamp		1.6 Nm ± 0.15 14.2 lb.in ± 1.33
Rail connection screw		1.6 Nm ± 0.15 14.2 lb.in ± 1.33

Accessories

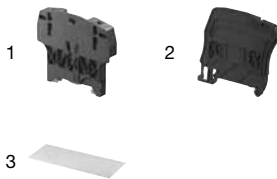

Description	Color	Type	Catalog number	Packing pieces	Weight 1 pc (g)
1 End Stops 10 mm 0.394 in	Dark Grey	BAZH1	1SNK900102R0000	20	23.90
2 Circuit Separators 3 mm 0.118 in	Dark Grey	CS-R1	1SNK900103R0000	20	5.20
3 Terminal Block Markers	White	MC812	1SNK160000R0000	22	10.00
	White	MC812PA	1SNK169999R0000	20	14.00
	Grey	UMH	1SNK900611R0000	10	0.20
Self adhesive strip	White	SAT8	1SNK900616R0000	5	6.00

Some accessories may modify the terminal block's ratings. See complete information in "Technical Datasheet".

ZS70-PE Screw clamp terminal blocks

Ground

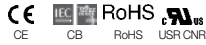

Technical Datasheet 1SNK 161 022 D0201

22 mm 0.866 in spacing

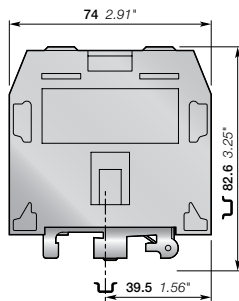

Features and Benefits

Reliable electrical and mechanical contact with the rail that exceeds the requirements of IEC 60947-7-2 terminal block standard.

Ordering Details

Description	Color	Type	Catalog number	Packing pieces	Weight 1 pc (g)
Ground Screw rail connection	Green-Yellow	ZS70-PE	1SNK522150R0000	10	222.00

Main Technical Data

Connecting capacity	IEC	cULus - CSA
1 conductor per clamp	Rigid	16-95 mm ²
	Flexible	16-70 mm ²
	with non insulated ferrule	16-50 mm ²
	with insulated ferrule	16-50 mm ²
Gauge	B11	
Rated cross section	70 mm ²	00 AWG
Rated short-time withstand current (1s)	8400 A	8088 A
Protection	IP10	NEMA 1
Explosive atmosphere classification	IM2 II 2 GD Ex e I/II	

Mounting Instructions

Rail		TH 35-15
Wire stripping length		25 mm 0.984 in
Tool		Allen Key Ø 6 mm Ø 0.236 in
Screw clamp		Ø 4 mm Ø 0.158 in
Rail connection screw		Ø 4 mm Ø 0.158 in
Torque		6.5 Nm ± 0.5 57.5 lb.in ± 4.4
Screw clamp		2 Nm ± 0.5 17.7 lb.in ± 4.4
Rail connection screw		2 Nm ± 0.5 17.7 lb.in ± 4.4

10

Accessories

Description	Color	Type	Catalog number	Packing pieces	Weight 1 pc (g)
1 End Stops	Dark Grey	BAZH1	1SNK900102R0000	20	23.90
2 Terminal Block Markers	White	MC812	1SNK160000R0000	22	10.00
		MC812PA	1SNK169999R0000	20	14.00
	Grey	UMH	1SNK900611R0000	10	0.20
	White	SAT8	1SNK900616R0000	5	6.00

Some accessories may modify the terminal block's ratings. See complete information in "Technical Datasheet".

ZS95-PE Screw clamp terminal blocks

Ground



Technical Datasheet 1SNK 161 024 D0201

26 mm 1.02 in spacing

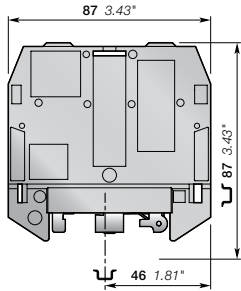
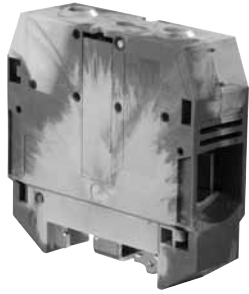

Features and Benefits

Reliable electrical and mechanical contact with the rail that exceeds the requirements of IEC 60947-7-2 terminal block standard.

Ordering Details

Description	Color	Type	Catalog number	Packing pieces	Weight 1 pc (g)
Ground Screw rail connection	Green-Yellow	ZS95-PE	1SNK526150R0000	10	278.00

Main Technical Data

Connecting capacity	IEC	cULus - CSA
1 conductor per clamp	Rigid 35-120 mm ² Flexible 35-95 mm ²	2-0000 AWG
	with non insulated ferrule 35-50 mm ² with insulated ferrule 35-50 mm ²	
Gauge		B12
Rated cross section	95 mm ²	0000 AWG
Rated short-time withstand current (1s)	11400 A	12840 A
Protection	IP10	NEMA 1
Explosive atmosphere classification	IM2 II 2 GD Ex e I/II	

Mounting Instructions

Rail		TH 35-15
Wire stripping length		26 mm 1.023 in
Tool		Allen Key Ø 6 mm Ø 0.236 in
Screw clamp		Ø 4 mm Ø 0.158 in
Rail connection screw		Ø 0.158 in
Torque		
Screw clamp		9.25 Nm ± 0.25 81.7 lb.in ± 2.2
Rail connection screw		2 Nm ± 0.25 17.7 lb.in ± 2.2

Accessories



Description	Color	Type	Catalog number	Packing pieces	Weight 1 pc (g)
1 End Stops 10 mm 0.394 in	Dark Grey	BAZH1	1SNK900102R0000	20	23.90
2 Terminal Block Markers	White	MC812	1SNK160000R0000	22	10.00
		MC812PA	1SNK169999R0000	20	14.00
	Universal wire markers holder	Grey	UMH	1SNK900611R0000	10
Self adhesive strip	White	SAT8	1SNK900616R0000	5	6.00

Some accessories may modify the terminal block's ratings. See complete information in "Technical Datasheet".

ZS6-D1-PE Screw clamp terminal blocks

Double deck with 2 ground circuits

6mm 0.236 in spacing



ZS6-D1-PE

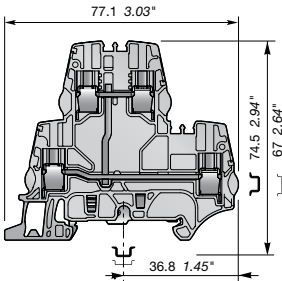

6 mm 0.236 in Spacing

Description

- Save space with double deck ground terminal blocks aligned with ZS6-D2 double deck terminal blocks for convenient cabling process and circuit configuration;
- Benefit from our screwless rail connection: non operator independant, secured snap on or remove from the rail, performances above the requirements of IEC 60947-7-2 standard

Ordering Details

Description	Color	Type	Catalog number	Pkg pce	Weight (1 pce) g
Double deck 2 ground circuits	Green-Yellow	ZS6-D1-PE	1SNK506250R0000	50	18,41

Main Technical Data

Connecting capacity		IEC	UL - CSA	Rail		
1 conductor per clamp	Rigid - Solid / Stranded	0.2-6 mm ²	24-10 AWG	Wire stripping length		TH 35-7.5, TH 35-15
	Flexible	0.22-6 mm ²				10 mm 0.394 in
	with non insulated ferrule	0.22-4 mm ²	24-12 AWG			
	with insulated ferrule	0.22-4 mm ²	24-12 AWG			
Gauge		A4-B3		Tool		Flat screwdriver Ø 4 mm Ø 0.157 in
Rated cross section		6 mm ²	10 AWG			
Rated short-time withstand current (1s)		720 A				
Protection		IP20	NEMA 1	Torque		0.85 N.m ± 0.15 7.52 lb.in ± 1.33
Explosive atmosphere classification						

The connecting capacity data for one Rigid - Solid / Stranded - Flexible conductor (when apply) is a mandatory information required by IEC, UL and CSA standards. All other data are provided as supplementary information only. For more details, please consult our CB, UL or CSA certificates and technical datasheet available on <http://www.ABB.com>

CE	IEC	RoHS	UL	CSA	Gost R														
CE	CB	RoHS	ULR	CSA	Gost R														

Accessories

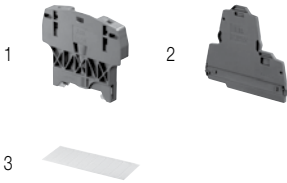

Description	Color	Type	Catalog number	Pkg pce	Weight (1 pce) g
1 End Stops	Dark Grey	BAZH1	1SNK900102R0000	20	23,90
2 End Sections	Dark Grey	ES4-D2	1SNK505960R0000	20	4,10
3 Terminal Block Markers	White	MC612	1SNK150000R0000	22	10,00
	Grey	MC612PA	1SNK159999R0000	20	11,00
Universal wire markers holder	Grey	UMH	1SNK900611R0000	10	0,20
Self adhesive strip	White	SAT6	1SNK900615R0000	5	6,00

Complete list of accessories is indicated in the terminal block datasheet. Some accessories such as jumper bars may modify the terminal block's ratings: complete information in the accessories catalogue pages.

ZS6-D2-PE Screw clamp terminal blocks

Double deck with 1 feed-through circuit and 1 ground circuit
6mm 0.236 in spacing

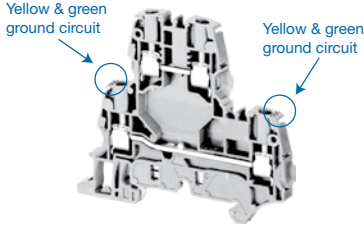

ZS6-D2-PE

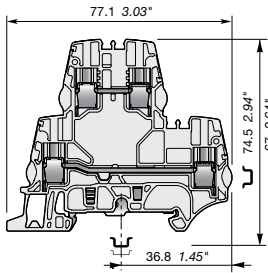

6 mm 0.236 in Spacing

Description

- Save space with ZS6-D2-PE terminal blocks: 1 feed-through circuit and 1 ground circuit in just 6 mm 0.236 in spacing;
- Customize yourself the ZS6-D2-PE terminal blocks by soldering electronic components (up to 8.8 mm x 3.2 mm 0.346 x 0.125 in) in the existing linking bars punching.

Ordering Details

Description	Color	Type	Catalog number	Pkg pce	Weight (1 pce) g
Double deck 1 Feed-through Circuit and 1 Ground circuit	Grey <input type="checkbox"/>	ZS6-D2-PE	1SNK506212R0000	50	18.41

Main Technical Data

Connecting capacity		IEC	UL - CSA
1 conductor per clamp	Rigid - Solid / Stranded	0.2-6 mm ²	24-10 AWG
	Flexible	0.22-6 mm ²	
	with non insulated ferrule	0.22-4 mm ²	24-12 AWG
	with insulated ferrule	0.22-4 mm ²	24-12 AWG
Gauge		A4-B3	
2 conductors per clamp	Rigid - Solid / Stranded	0.2-2.5 mm ²	24-14 AWG
	Flexible	0.2-2.5 mm ²	
	with twin ferrule	0.22-2.5 mm ²	24-14 AWG
Rated current / Rated cross section		41 A / 6 mm ²	30 A / 10 AWG
Rated short-time withstand current (1s)		720 A	
Short Circuit Current Rating (with specific conditions)			
Rated voltage		800 V	300 V
Impulse withstand voltage		8000 V	
Protection		IP20	NEMA 1

Mounting Instructions

Tool	Requirement
Rail	TH 35-7.5, TH 35-15
Wire stripping length	10 mm 0.394 in
Tool	Flat screwdriver Ø 4 mm Ø 0.157 in
Torque	0.85 N.m ± 0.15 7.52 lb.in ± 1.33

Rated voltage Ex e

The connecting capacity data for one Rigid - Solid / Stranded - Flexible conductor (when apply) is a mandatory information required by IEC, UL and CSA standards. All other data are provided as supplementary information only. For more details, please consult our CB, UL or CSA certificates and technical datasheet available on <http://www.ABB.com>

CE	IEC CB	RoHS	UL	CSA	Gost R
CE	CB	RoHS	UL	CSA	Gost R

Accessories

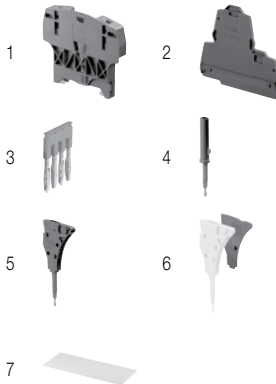

Description	Color	Type	Catalog number	Pkg pce	Weight (1 pce) g
1 End Stops 10 mm 0.394 in	Dark Grey	BAZH1	1SNK900102R0000	20	23.90
2 End Sections 2.55 mm 0.100 in	Dark Grey	ES4-D2	1SNK505960R0000	20	4.10
3 Jumper Bars 2 poles 41 A 30 A	Orange	JB6-2	1SNK906302R0000	50	1.30
		3 poles JB6-3	1SNK906303R0000	50	2.10
		4 poles JB6-4	1SNK906304R0000	50	2.90
		5 poles JB6-5	1SNK906305R0000	50	3.60
		10 poles JB6-10	1SNK906310R0000	20	7.40
4 Test Adapters For test plugs DIA 4 mm 0.160 in	Dark Grey	TP4	1SNK900205R0000	20	2.41
5 Test Connectors End module, 5.2 mm 0.205 in	Dark Grey	TC5-R1	1SNK900201R0000	10	5.23
6 Spacers	Dark Grey	ES-TC6	1SNK900105R0000	10	0.80
7 Terminal Block Markers	White	MC612	1SNK15000R0000	22	10.00
	White	MC612PA	1SNK15999R0000	20	11.00
	Grey	UMH	1SNK900611R0000	10	0.20
Self adhesive strip	White	SAT6	1SNK900615R0000	5	6.00

Complete list of accessories is indicated in the terminal block datasheet. Some accessories such as jumper bars may modify the terminal block's ratings: complete information in the accessories catalogue pages.

ZS4-S Screw clamp terminal blocks

Disconnect with blade



Technical Datasheet 1SNK 161 010 D0201

5.2 mm 0.205 in spacing

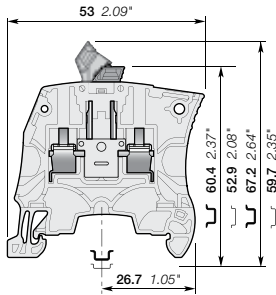

Features and Benefits

- Ease your disconnect operations with the disconnect blade operated by hand or with a screwdriver,
- Same profile as ZS4 feed-through terminal block for aligned marking and identical end section use.

Ordering Details

Description	Color	Type	Catalog number	Packing pieces	Weight 1 pc (g)
Profile aligned with ZS4	Grey	ZS4-S	1SNK505310R0000	50	8.60
	Blue	ZS4-S-BL	1SNK505320R0000	50	8.60
	Orange	ZS4-S-OR	1SNK505330R0000	50	8.60

Main Technical Data

Connecting capacity	IEC	cULus - CSA
1 conductor per clamp	Rigid	0.2-4 mm ²
	Flexible	0.22-4 mm ²
	with non insulated ferrule	0.22-4 mm ²
	with insulated ferrule	0.22-2.5 mm ²
	Gauge	A3-B3
2 conductors per clamp	Rigid	0.2-1.5 mm ²
	Flexible	0.2-1.5 mm ²
	with twin ferrule	0.22-1.5 mm ²
Rated cross section	4 mm ²	10 AWG
Rated current	25 A	25 A
Rated short-time withstand current (1s)	480 A	
Rated voltage	400 V	150 V
Impulse withstand voltage	6000 V	
Protection	IP20	NEMA 1

Mounting Instructions

Rail		TH 35-7.5, TH 35-15
Wire stripping length		10.5 mm 0.413 in
Tool		Flat screwdriver Ø 3.5 mm Ø 0.138 in
Torque		0.6 Nm ± 0.1 5.31 lb.in ± 0.885

10

Accessories

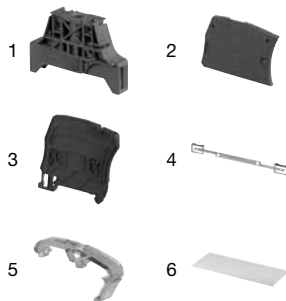

Description	Color	Type	Catalog number	Packing pieces	Weight 1 pc (g)	
1 End Stops	Screw; 10mm 0.394 in	BAM3	1SNK900001R0000	50	13.80	
	Screwless; 5.2mm 0.205 in	BAZ1	1SNK900002R0000	50	5.30	
2 End Sections	2.2 mm 0.087 in	ES4	1SNK505910R0000	20	2.18	
3 Circuit Separators	3 mm 0.118 in	CS-R1	1SNK900103R0000	20	5.20	
4 Shield Connectors		SHBS	1SNK900600R0000	20	3.50	
5 Protecting Covers	5.2 mm 0.205 in spacing	Transparent	PL5	1SNK900618R0000	10	1.50
		White	MC512	1SNK140000R0000	22	9.00
6 Terminal Block Markers	Blank card	Universal wire markers holder	UMH	1SNK900611R0000	10	0.20
		Self adhesive strip	SAT5	1SNK900614R0000	5	6.00

Some accessories may modify the terminal block's ratings. See complete information in "Technical Datasheet".

ZS6-S Screw clamp terminal blocks

Disconnect with blade
6mm 0.236 in spacing



Description

- Ease your disconnect operations with the disconnect blade operated by hand or with a screwdriver,
- Same profile as ZS6 feed-through terminal block for aligned marking and identical end section use.

Ordering Details

Description	Color	Type	Catalog number	Pkg pce	Weight (1 pce) g
Disconnect Profile aligned with ZS6	Grey	ZS6-S	1SNK506315R0000	50	8.60
	Blue	ZS6-S-BL	1SNK506322R0000	50	8.60

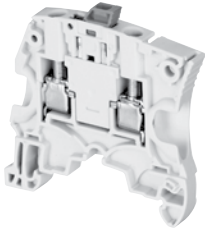

ZS6-S

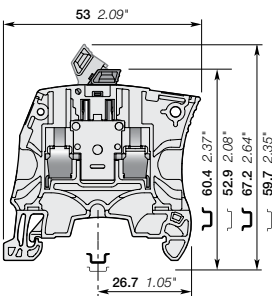

6 mm 0.236 in Spacing

Main Technical Data

Connecting capacity		IEC	UL - CSA	Rail	TH 35-7.5, TH 35-15
1 conductor per clamp	Rigid - Solid / Stranded	0.2-6 mm ²	24-10 AWG	Wire stripping length	10.5 mm 0.413 in
	Flexible	0.22-6 mm ²			
	with non insulated ferrule	0.22-6 mm ²	24-12 AWG		
	with insulated ferrule	0.22-4 mm ²	24-12 AWG		
	Gauge	A4-B3			
2 conductors per clamp	Rigid - Solid / Stranded	0.2-2.5 mm ²	24-14 AWG	Tool	Flat screwdriver Ø 4 mm Ø 0.157 in
	Flexible	0.22-2.5 mm ²			
	with twin ferrule	0.22-2.5 mm ²	24-14 AWG		
Rated current / Rated cross section		25 A / 4 mm ²	25 A / 10 AWG	Torque	0.85 N.m ± 0.15 7.52 lb.in ± 1.33
Maximum current / Maximum cross section		25 A / 6 mm ²			
Rated short-time withstand current (1s)		480 A			
Rated voltage		500 V	150 V		
Impulse withstand voltage		6000 V			
Protection		IP20	NEMA 1		

Mounting Instructions

Recommendation for best usage: in horizontal assemblies, disconnect terminal blocks should be mounted with fixed foot on top (power side) so that the disconnect knife does not partially close through gravity. Furthermore, as specified per IEC 60947-7-1, disconnect terminal blocks are intended to be used for temporary disconnection at zero potential and at no load.

The connecting capacity data for one Rigid - Solid / Stranded - Flexible conductor (when apply) is a mandatory information required by IEC, UL and CSA standards.

All other data are provided as supplementary information only. For more details, please consult our CB, UL or CSA certificates and technical datasheet available on <http://www.ABB.com>

CE	IEC CB	RoHS	USR	CSA	Gost R														
----	--------	------	-----	-----	--------	--	--	--	--	--	--	--	--	--	--	--	--	--	--

Accessories

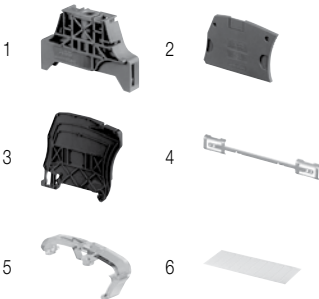

Description	Color	Type	Catalog number	Pkg pce	Weight (1 pce) g	
1 End Stops	Dark Grey	Screw; 10 mm 0.394 in	BAM3	1SNK900001R0000	50	13.80
		Screwless; 10 mm 0.394 in	BAZ1	1SNK900002R0000	50	5.30
2 End Sections	Dark Grey		ES4	1SNK505910R0000	20	2.18
3 Circuit Separators	Dark Grey		CS-R1	1SNK900103R0000	20	5.20
4 Shield Connectors			SHBS	1SNK900600R0000	20	3.50
5 Protecting Covers	Transparent		PL6	1SNK900619R0000	10	1.84
6 Terminal Block Markers	White	Blank card	MC612	1SNK150000R0000	22	10.00
			MC612PA	1SNK159999R0000	20	11.00
		Universal wire markers holder	UMH	1SNK900611R0000	10	0.20
	White		SAT6	1SNK900615R0000	5	6.00

Complete list of accessories is indicated in the terminal block datasheet.

Some accessories such as jumper bars may modify the terminal block's ratings: complete information in the accessories catalogue pages.

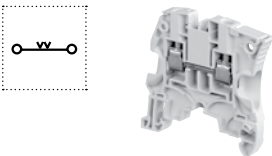

Feed-through Screw Clamp Terminal Blocks

Description	Color	Type	Catalog number	Pkg pce	Weight (1 pce) g
Feed-through	Grey	ZS6	1SNK506010R0000	50	10.64

All the technical data for UL/CSA standard and dimensions in inches are in *italics*.

ZS10-S Screw clamp terminal blocks

Disconnect with blade
8mm 0.0315 in spacing

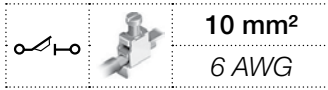

Description

- Ease your disconnect operations with the disconnect blade operated by hand or with a screwdriver,
- Same profile as ZS10 feed-through terminal block for aligned marking and identical end section use.

Ordering Details

Description	Color	Type	Catalog number	Pkg pce	Weight (1 pce) g
Disconnect Profile aligned with ZS10	Grey	ZS10-S	1SNK508315R0000	50	8.60
	Blue	ZS10-S-BL	1SNK508320R0000	50	8.60

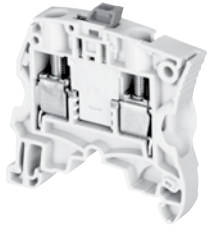

ZS10-S

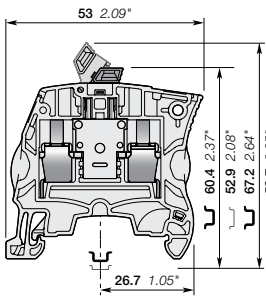

8 mm 0.315 in Spacing

Main Technical Data

Connecting capacity		IEC	UL - CSA	Rail		TH 35-7.5, TH 35-15
1 conductor per clamp	Rigid - Solid / Stranded	0.2-10 mm ²	24-6 AWG	Wire stripping length		12 mm 0.472 in
	Flexible	0.22-10 mm ²				
	with non insulated ferrule	0.22-10 mm ²	24-12 AWG			
	with insulated ferrule	0.22-6 mm ²	24-12 AWG			
2 conductors per clamp	Rigid - Solid / Stranded	0.5-4 mm ²	20-12 AWG	Tool		Flat screwdriver Ø 4 mm Ø 0.157 in
	Flexible	0.5-4 mm ²				
	with twin ferrule	0.5-4 mm ²	20-12 AWG			
Rated current / Rated cross section		25 A / 4 mm ²	25 A / 6 AWG	Torque		1.3 N.m ± 0.3 11.5 lb.in ± 2.65
Maximum current / Maximum cross section		25 A / 10 mm ²				
Rated short-time withstand current (1s)		480 A				
Rated voltage		630 V	150 V			
Impulse withstand voltage		6000 V				
Protection		IP20	NEMA 1			

10

Recommendation for best usage: in horizontal assemblies, disconnect terminal blocks should be mounted with fixed foot on top (power side) so that the disconnect knife does not partially close through gravity. Furthermore, as specified per IEC 60947-7-1, disconnect terminal blocks are intended to be used for temporary disconnection at zero potential and at no load.

The connecting capacity data for one Rigid - Solid / Stranded - Flexible conductor (when apply) is a mandatory information required by IEC, UL and CSA standards. All other data are provided as supplementary information only. For more details, please consult our CB, UL or CSA certificates and technical datasheet available on <http://www.ABB.com>

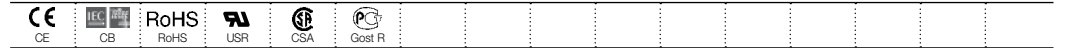

Accessories

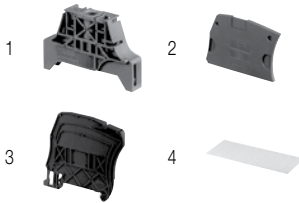

Description	Color	Type	Catalog number	Pkg pce	Weight (1 pce) g	
1 End Stops	Screw; 10 mm 0.394 in	Dark Grey	BAM3	1SNK900001R0000	50	13.80
	Screwless; 10 mm 0.394 in	Dark Grey	BAZ1	1SNK900002R0000	50	5.30
2 End Sections	2.2 mm 0.087 in	Dark Grey	ES4	1SNK505910R0000	20	2.18
3 Circuit Separators	3 mm 0.118 in	Dark Grey	CS-R1	1SNK900103R0000	20	5.20
4 Terminal Block Markers	Blank card	White	MC812	1SNK160000R0000	22	10.00
	Universal wire markers holder	Grey	UMH	1SNK900611R0000	10	0.20
	Self adhesive strip	White	SAT8	1SNK900616R0000	5	6.00

Complete list of accessories is indicated in the terminal block datasheet. Some accessories such as jumper bars may modify the terminal block's ratings: complete information in the accessories catalogue pages.

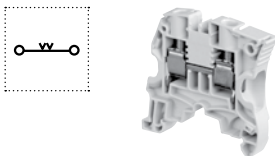

Feed-through Screw Clamp Terminal Blocks

Description	Color	Type	Catalog number	Pkg pce	Weight (1 pce) g
Feed-through	Grey	ZS10	1SNK508010R0000	50	14.10

All the technical data for UL/CSA standard and dimensions in inches are in *italics*.

ZS4-S-T Screw clamp terminal blocks

Disconnect with blade - with test socket screws

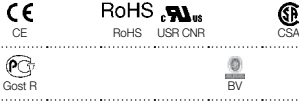

Technical Datasheet 1SNK 161 042 D0201

5.2 mm 0.205 in spacing

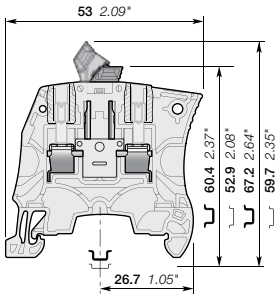
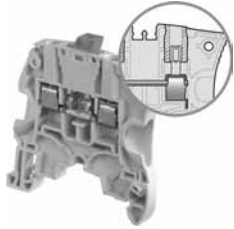

Features and Benefits

- Ease your test operations with the two built-in test socket screws,
- Screwdriver or hand operated disconnect blade,
- Same profile as ZS4 feed-through terminal block for aligned marking and identical end section use.

Ordering Details

Description	Color	Type	Catalog number	Packing pieces	Weight 1 pc (g)
Profile aligned with ZS4, with 2 test socket screws DIA 2 mm 0.079 in	Grey	ZS4-S-T2	1SNK505311R0000	50	8.90
	Blue	ZS4-S-T2-BL	1SNK505321R0000	50	8.90
	Orange	ZS4-S-T2-OR	1SNK505331R0000	50	8.90
Profile aligned with ZS4, with 2 test socket screws DIA 2.3 mm 0.091 in	Grey	ZS4-S-T2.3	1SNK505312R0000	50	8.80

Main Technical Data

Connecting capacity	IEC	cULus - CSA
1 conductor per clamp	Rigid	0.2-4 mm ²
	Flexible	0.22-4 mm ²
	with non insulated ferrule	0.22-4 mm ²
	with insulated ferrule	0.22-2.5 mm ²
	Gauge	A3-B3
2 conductors per clamp	Rigid	0.2-1.5 mm ²
	Flexible	0.2-1.5 mm ²
	with twin ferrule	0.22-1.5 mm ²
Rated cross section	4 mm ²	10 AWG
Rated current	25 A	25 A
Rated short-time withstand current (1s)	480 A	
Rated voltage	400 V	150 V
Impulse withstand voltage	6000 V	
Protection	IP20	NEMA 1

Mounting Instructions

Rail		TH 35-7.5, TH 35-15
Wire stripping length		10.5 mm 0.413 in
Tool		Flat screwdriver Ø 3.5 mm Ø 0.138 in
Torque		0.6 Nm ± 0.1 5.31 lb.in ± 0.885

Accessories

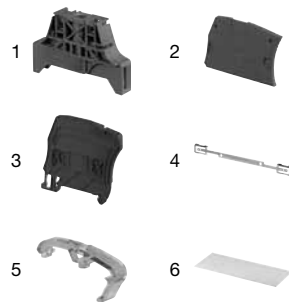

Description	Color	Type	Catalog number	Packing pieces	Weight 1 pc (g)
1 End Stops	Screw; 10mm 0.394 in	BAM3	1SNK900001R0000	50	13.80
	Screwless; 5.2mm 0.205 in	BAZ1	1SNK900002R0000	50	5.30
2 End Sections	2.2 mm 0.087 in	ES4	1SNK505910R0000	20	2.18
3 Circuit Separators	3 mm 0.118 in	CS-R1	1SNK900103R0000	20	5.20
4 Shield Connectors		SHBS	1SNK900600R0000	20	3.50
5 Protecting Covers	5.2 mm 0.205 in spacing	PL5	1SNK900618R0000	10	1.50
6 Terminal Block Markers	Blank card	MC512	1SNK140000R0000	22	9.00
	Universal wire markers holder	UMH	1SNK900611R0000	10	0.20
	Self adhesive strip	SAT5	1SNK900614R0000	5	6.00

Some accessories may modify the terminal block's ratings. See complete information in "Technical Datasheet".

ZS4-S-R1 Screw clamp terminal blocks

Disconnect with blade



Technical Datasheet 1SNK 161 012 D0201

6 mm 0.236 in spacing

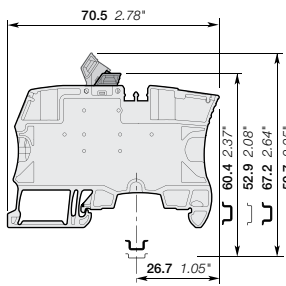

Features and Benefits

- Simplify the alternated distribution thanks to the two jumper channels aligned with ZS4 feed-through terminal blocks,
- Ease your disconnect operations with the disconnect blade operated by hand or with a screwdriver.

Ordering Details

Description	Color	Type	Catalog number	Packing pieces	Weight 1 pc (g)
Profile aligned with ZS4-SF	Grey	ZS4-S-R1	1SNK506310R0000	50	13.20
	Blue	ZS4-S-R1-BL	1SNK506320R0000	50	13.20
	Orange	ZS4-S-R1-OR	1SNK506330R0000	50	13.20

Main Technical Data

Connecting capacity	IEC	cULus - CSA
1 conductor per clamp	Rigid	0.2-4 mm ²
	Flexible	0.22-4 mm ²
	with non insulated ferrule	0.22-4 mm ²
	with insulated ferrule	0.22-4 mm ²
	Gauge	A3-B3
2 conductors per clamp	Rigid	0.2-1.5 mm ²
	Flexible	0.2-1.5 mm ²
	with twin ferrule	0.22-1.5 mm ²
Rated cross section	4 mm ²	10 AWG
Rated current	26 A	26 A
Rated short-time withstand current (1s)	480 A	
Rated voltage	400 V	150 V
Impulse withstand voltage	6000 V	
Protection	IP20	NEMA 1

Mounting Instructions

Rail		TH 35-7.5, TH 35-15
Wire stripping length		10.5 mm 0.413 in
Tool		Flat screwdriver Ø 3.5 mm Ø 0.138 in
Torque		0.6 Nm ± 0.1 5.31 lb.in ± 0.885

10

Accessories

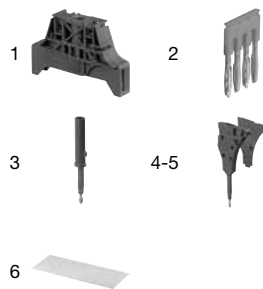

Description	Color	Type	Catalog number	Packing pieces	Weight 1 pc (g)			
1 End Stops	Dark Grey	BAM3	1SNK900001R0000	50	13.80			
	Dark Grey	BAZ1	1SNK900002R0000	50	5.30			
2 Jumper Bars	Orange	2 poles	41 A	30 A	JB6-2	1SNK906302R0000	50	1.30
		3 poles	JB6-3	1SNK906303R0000	50	2.10		
		4 poles	JB6-4	1SNK906304R0000	50	2.90		
		5 poles	JB6-5	1SNK906305R0000	50	3.60		
		10 poles	JB6-10	1SNK906310R0000	20	7.40		
3 Test Adapters	Dark Grey	For test plugs DIA 2 mm 0.079 in	TP2	1SNK900203R0000	20	1.73		
		For test plugs DIA 4 mm 0.160 in	TP4	1SNK900205R0000	20	2.42		
4 Test Connectors	Dark Grey	TC5-R1	1SNK900201R0000	10	5.23			
5 Spacers	Dark Grey	ES-TC6	1SNK900105R0000	10	0.80			
6 Terminal Block Markers	White	MC612	1SNK150000R0000	22	10.00			
		MC612PA	1SNK159999R0000	20	11.00			
	Universal wire markers holder	Grey	UMH	1SNK900611R0000	10	0.20		
	Self adhesive strip	White	SAT6	1SNK900615R0000	5	6.00		

Some accessories may modify the terminal block's ratings. See complete information in "Technical Datasheet".

ZS4-S-T-R1 Screw clamp terminal blocks

Disconnect with blade - with test socket screws

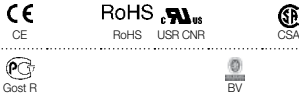

Technical Datasheet 1SNK 161 045 D0201

6 mm 0.236 in spacing

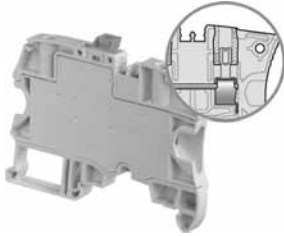

10

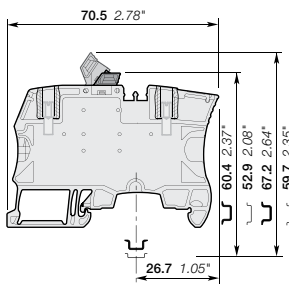

Features and Benefits

- Ease your test operations with the two built-in test socket screws,
- Screwdriver or hand operated disconnect blade,
- Simplify the alternated distribution thanks to the two jumper channels aligned with ZS4 feed-through terminal blocks.

Ordering Details

Description	Color	Type	Catalog number	Packing pieces	Weight 1 pc (g)
Profile aligned with ZS4-SF, with 2 test socket screws DIA 2 mm 0.079 in	Grey	ZS4-S-T2-R1	1SNK506311R0000	50	14.20
	Blue	ZS4-S-T2-R1-BL	1SNK506321R0000	50	14.20
	Orange	ZS4-S-T2-R1-OR	1SNK506331R0000	50	14.20
Profile aligned with ZS4-SF, with 2 test socket screws DIA 2.3 mm 0.091 in	Grey	ZS4-S-T2.3-R1	1SNK506312R0000	50	14.20

Main Technical Data

Connecting capacity	IEC	cULus - CSA
1 conductor per clamp	Rigid	0.2-4 mm ²
	Flexible	0.22-4 mm ²
	with non insulated ferrule	0.22-4 mm ²
	with insulated ferrule	0.22-4 mm ²
	Gauge	A3-B3
2 conductors per clamp	Rigid	0.2-1.5 mm ²
	Flexible	0.2-1.5 mm ²
	with twin ferrule	0.22-1.5 mm ²
Rated cross section	4 mm ²	10 AWG
Rated current	26 A	26 A
Rated short-time withstand current (1s)	480 A	
Rated voltage	400 V	150 V
Impulse withstand voltage	6000 V	
Protection	IP20	NEMA 1

Mounting Instructions

Rail		TH 35-7.5, TH 35-15
Wire stripping length		10.5 mm 0.413 in
Tool		Flat screwdriver Ø 3.5 mm Ø 0.138 in
Torque		0.6 Nm ± 0.1 5.31 lb.in ± 0.885

Accessories

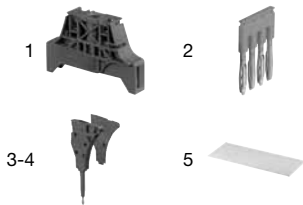

Description	Color	Type	Catalog number	Packing pieces	Weight 1 pc (g)	
1 End Stops	Screw; 10mm 0.394 in	BAM3	1SNK900001R0000	50	13.80	
	Screwless; 5.2mm 0.205 in	BAZ1	1SNK900002R0000	50	5.30	
2 Jumper Bars	2 poles	JB6-2	1SNK906302R0000	50	1.30	
	3 poles	JB6-3	1SNK906303R0000	50	2.10	
	4 poles	JB6-4	1SNK906304R0000	50	2.90	
	5 poles	JB6-5	1SNK906305R0000	50	3.60	
	10 poles	JB6-10	1SNK906310R0000	20	7.40	
3 Test Connectors	End module, 5.2 mm 0.205 in	TC5-R1	1SNK900201R0000	10	5.23	
4 Spacers	0.8 mm 0.031 in spacing	ES-TC6	1SNK900105R0000	10	0.80	
5 Terminal Block Markers	Blank card	MC612	1SNK150000R0000	22	10.00	
		MC612PA	1SNK159999R0000	20	11.00	
	Universal wire markers holder	Grey	UMH	1SNK900611R0000	10	0.20
	Self adhesive strip	White	SAT6	1SNK900615R0000	5	6.00

Some accessories may modify the terminal block's ratings. See complete information in "Technical Datasheet".

ZS4-SP Screw clamp terminal blocks

Disconnect with plug



Technical Datasheet 1SNK 161 033 D0201

5.2 mm 0.205 in spacing

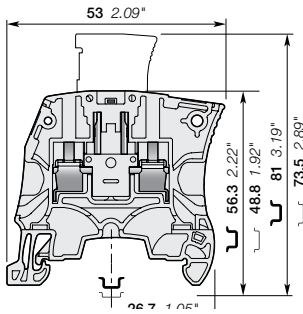

Features and Benefits

- Save time with our screwless component holder plug,
- Same profile as ZS4 feed-through terminal block for aligned marking and identical end section use.

Ordering Details

Description	Color	Type	Catalog number	Packing pieces	Weight 1 pc (g)
Profile aligned with ZS4, plug delivered separately	Grey	ZS4-SP	1SNK505313R0000	50	8.20

Main Technical Data

Connecting capacity	IEC	cULus - CSA
1 conductor per clamp	Rigid	0.2-4 mm ²
	Flexible	0.22-4 mm ²
	with non insulated ferrule	0.22-4 mm ²
	with insulated ferrule	0.22-2.5 mm ²
Gauge	A3-B3	
2 conductors per clamp	Rigid	0.2-1.5 mm ²
	Flexible	0.2-1.5 mm ²
	with twin ferrule	0.22-1.5 mm ²
Maximum cross section	4 mm ²	10 AWG
Max. current / Max. cross section	20 A	18 A
Rated short-time withstand current (1s)	480 A	
Rated voltage	400 V	150 V
Impulse withstand voltage	6000 V	
Protection	IP20	NEMA 1

Mounting Instructions

Rail		TH 35-7.5, TH 35-15
Wire stripping length		10.5 mm 0.413 in
Tool		Flat screwdriver Ø 3.5 mm Ø 0.138 in
Torque		0.6 Nm ± 0.1 5.31 lb.in ± 0.885

10

Accessories

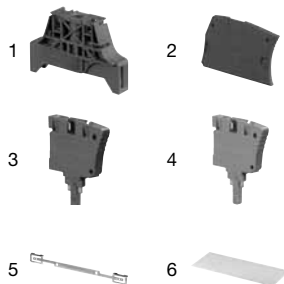

Description	Color	Type	Catalog number	Packing pieces	Weight 1 pc (g)
1 End Stops	Dark Grey	BAM3	1SNK900001R0000	50	13.80
	Dark Grey	BAZ1	1SNK900002R0000	50	5.30
2 End Sections	Dark Grey	ES4	1SNK505910R0000	20	2.18
3 Component Plugs	Dark Grey	PG5	1SNK900401R0000	20	3.45
4 Disconnect Plugs	Orange	PG5-R1	1SNK900402R0000	20	3.45
5 Shield Connectors		SHBS	1SNK900600R0000	20	3.50
6 Terminal Block Markers	White	MC512	1SNK140000R0000	22	9.00
	White	MC512PA	1SNK149999R0000	20	10.00
	Grey	UMH	1SNK900611R0000	10	0.20
	White	SAT5	1SNK900614R0000	5	6.00

Some accessories may modify the terminal block's ratings. See complete information in "Technical Datasheet".

ZS10-SP Screw clamp terminal blocks

Disconnect with plug
8mm 0.315 in spacing

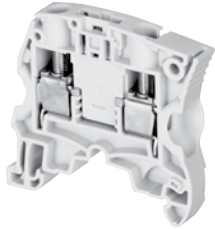

ZS10-SP

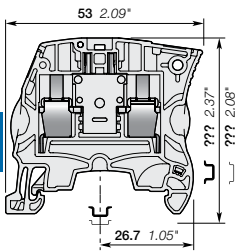

8 mm 0.315 in Spacing

Description

- Save time with our screwless component holder plug,
- Same profile as ZS10 feed-through terminal block for aligned marking and identical end section use.

Ordering Details

Description	Color	Type	Catalog number	Pkg pce	Weight (1 pce) g
Disconnect Profile aligned with ZS10	Grey	ZS10-SP	1SNK508316R0000	50	8.60

Main Technical Data

Connecting capacity	IEC	UL - CSA	Rail	TH 35-7.5, TH 35-15
1 conductor per clamp	Rigid - Solid / Stranded	0.2-10 mm ²	Wire stripping length	12 mm 0.472 in
	Flexible	0.22-10 mm ²		
	with non insulated ferrule	0.22-10 mm ²	Tool	Flat screwdriver Ø 4 mm Ø 0.157 in
	with insulated ferrule	0.22-6 mm ²		
Gauge	A5-B5		Torque	1.3 N.m ± 0.3 11.5 lb.in ± 2.65
2 conductors per clamp	Rigid - Solid / Stranded	0.5-4 mm ²		
	Flexible	0.5-4 mm ²		
	with twin ferrule	0.5-4 mm ²		
Rated current / Rated cross section	18 A / 2.5 mm ²	18 A / 6 AWG		
Maximum current / Maximum cross section	18 A / 10 mm ²			
Rated short-time withstand current (1s)	300 A			
Rated voltage	630 V	150 V		
Impulse withstand voltage	6000 V			
Protection	IP20	NEMA 1		

Mounting Instructions

The connecting capacity data for one Rigid - Solid / Stranded - Flexible conductor (when apply) is a mandatory information required by IEC, UL and CSA standards. All other data are provided as supplementary information only. For more details, please consult our CB, UL or CSA certificates and technical datasheet available on <http://www.ABB.com>

CE	RoHS	UR	CSA	Gost R
CE	RoHS	UR	CSA	Gost R

Accessories

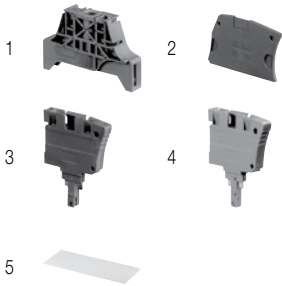

Description	Color	Type	Catalog number	Pkg pce	Weight (1 pce) g	
1 End Stops	Screw; 10 mm 0.394 in	Dark Grey	BAM3	1SNK900001R0000	50	13.80
	Screwless; 10 mm 0.394 in	Dark Grey	BAZ1	1SNK900002R0000	50	5.30
2 End Sections	2.2 mm 0.087 in	Dark Grey	ES4	1SNK505910R0000	20	2.18
3 Component Plugs	Components in series with circuit	Dark Grey	PG5	1SNK900401R0000	20	3.45
4 Disconnect Plugs	Equipped with linking bar	Orange	PG5-R1	1SNK900402R0000	20	3.45
5 Terminal Block Markers	Blank card	White	MC812	1SNK160000R0000	22	10.00
	Universal wire markers holder	Grey	UMH	1SNK900611R0000	10	0.20
	Self adhesive strip	White	SAT8	1SNK900616R0000	5	6.00

Complete list of accessories is indicated in the terminal block datasheet. Some accessories such as jumper bars may modify the terminal block's ratings: complete information in the accessories catalogue pages.

Feed-through Screw Clamp Terminal Blocks

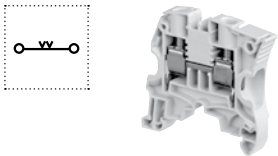

Description	Color	Type	Catalog number	Pkg pce	Weight (1 pce) g
Feed-through	Grey	ZS10	1SNK508010R0000	50	14.10

All the technical data for UL/CSA standard and dimensions in inches are in *italic*.

ZS4-SP-T2 Screw clamp terminal blocks

Disconnect with plug - with test socket screws

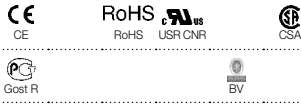

Technical Datasheet 1SNK 161 041 D0201

5.2 mm 0.205 in spacing

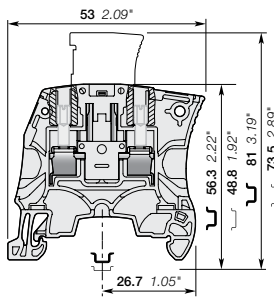
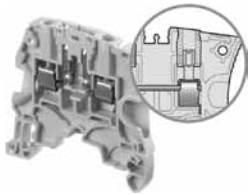

Features and Benefits

- Ease your test operations with the 2 built-in test socket screws DIA 2 mm 0.079 in,
- Save time with our screwless component holder plug,
- Same profile as ZS4 feed-through terminal block for aligned marking and identical end section use.

Ordering Details

Description	Color	Type	Catalog number	Packing pieces	Weight 1 pc (g)
Profile aligned with ZS4, with 2 test socket screws DIA 2 mm 0.079 in, plug delivered separately	Grey	ZS4-SP-T2	1SNK505314R0000	50	8.40

Main Technical Data

Connecting capacity	IEC	cULus - CSA
1 conductor per clamp	Rigid	0.2-4 mm ²
	Flexible	0.22-4 mm ²
	with non insulated ferrule	0.22-4 mm ²
	with insulated ferrule	0.22-2.5 mm ²
	Gauge	A3-B3
2 conductors per clamp	Rigid	0.2-1.5 mm ²
	Flexible	0.2-1.5 mm ²
	with twin ferrule	0.22-1.5 mm ²
Maximum cross section	4 mm ²	10 AWG
Max. current / Max. cross section	20 A	18 A
Rated short-time withstand current (1s)	480 A	
Rated voltage	400 V	150 V
Impulse withstand voltage	6000 V	
Protection	IP20	NEMA 1

Mounting Instructions

Rail		TH 35-7.5, TH 35-15
Wire stripping length		10.5 mm 0.413 in
Tool		Flat screwdriver Ø 3.5 mm Ø 0.138 in
Torque		0.6 Nm ± 0.1 5.31 lb.in ± 0.885

10

Accessories

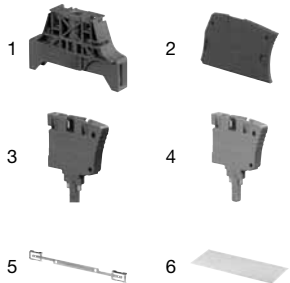

Description	Color	Type	Catalog number	Pack ^(ing) pieces	Weight (1 pc) g
1 End Stops	Dark Grey	BAM3	1SNK900001R0000	50	13.80
	Dark Grey	BAZ1	1SNK900002R0000	50	5.30
2 End Sections	Dark Grey	ES4	1SNK505910R0000	20	2.18
3 Component Plugs	Dark Grey	PG5	1SNK900401R0000	20	3.45
4 Disconnect Plugs	Orange	PG5-R1	1SNK900402R0000	20	3.45
5 Shield Connectors		SHBS	1SNK900600R0000	20	3.50
6 Terminal Block Markers	White	MC512	1SNK140000R0000	22	9.00
		MC512PA	1SNK149999R0000	20	10.00
	Grey	UMH	1SNK900611R0000	10	0.20
	White	SAT5	1SNK900614R0000	5	6.00

Some accessories may modify the terminal block's ratings. See complete information in "Technical Datasheet".

ZS4-SP-R1 Screw clamp terminal blocks

Disconnect with plug



Technical Datasheet 1SNK 161 039 D0201

6 mm 0.236 in spacing



10

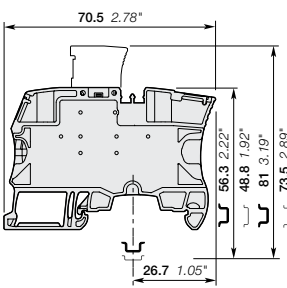

Features and Benefits

- Simplify the alternated distribution between feed-through and disconnect circuits thanks to the two aligned jumper channels,
- Save time with our screwless component holder plug.

Ordering Details

Description	Color	Type	Catalog number	Packing pieces	Weight 1 pc (g)
Profile aligned with ZS4-SF, plug delivered separately	Grey	ZS4-SP-R1	1SNK506313R0000	50	14.20

Main Technical Data

Connecting capacity	IEC	cULus - CSA
1 conductor per clamp	Rigid	24-10 AWG
	Flexible	24-10 AWG
	with non insulated ferrule	24-12 AWG
	with insulated ferrule	24-12 AWG
2 conductors per clamp	Gauge	A3-B3
	Rigid	24-16 AWG
	Flexible	24-16 AWG
	with twin ferrule	24-16 AWG
Maximum cross section	4 mm ²	10 AWG
Max. current / Max. cross section	20 A	20 A
Rated short-time withstand current (1s)	480 A	
Rated voltage	400 V	150 V
Impulse withstand voltage	6000 V	
Protection	IP20	NEMA 1

Mounting Instructions

Rail		TH 35-7.5, TH 35-15
Wire stripping length		10.5 mm 0.413 in
Tool		Flat screwdriver Ø 3.5 mm Ø 0.138 in
Torque		0.6 Nm ± 0.1 5.31 lb.in ± 0.885

Accessories

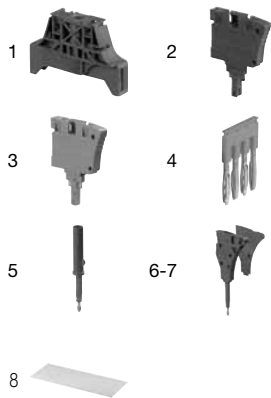

	Description	Color	Type	Catalog Number	Pack ⁽¹⁾ pieces	Weight (1 pce) g	
1	End Stops	Dark Grey	BAM3	1SNK900001R0000	50	13.80	
	Screwless; 5.2mm 0.205 in			BAZ1			1SNK900002R0000
2	Component Plugs	Dark Grey	PG5	1SNK900401R0000	20	3.45	
3	Disconnect Plugs	Orange	PG5-R1	1SNK900402R0000	20	3.45	
4	Jumper Bars	Orange	JB6-2	1SNK906302R0000	50	1.30	
				3 poles			1SNK906303R0000
				4 poles			1SNK906304R0000
				5 poles			1SNK906305R0000
				10 poles			1SNK906310R0000
5	Test Adapters	Dark Grey	TP2	1SNK900203R0000	20	1.73	
				TP4			1SNK900205R0000
6	Test Connectors	Dark Grey	TC5-R1	1SNK900201R0000	10	5.23	
7	Spacers	Dark Grey	ES-TC6	1SNK900105R0000	10	0.80	
8	Terminal Block Markers	White	MC612	1SNK150000R0000	22	10.00	
				MC612PA			1SNK159999R0000
		Grey	UMH	1SNK900611R0000	10	0.20	
		White	SAT6	1SNK900615R0000	5	6.00	

Some accessories may modify the terminal block's ratings. See complete information in "Technical Datasheet".

ZS4-SP-T2-R1 Screw clamp terminal blocks

Disconnect with plug – with test socket screws



Technical Datasheet 1SNK 161 040 D0201

6 mm 0.236 in spacing

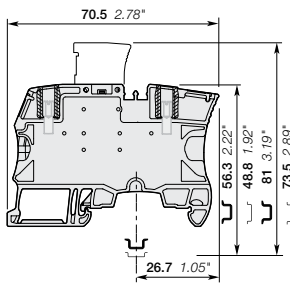
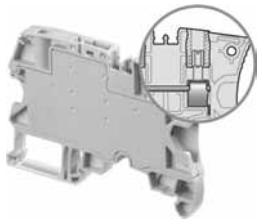

Features and Benefits

- Ease your test operations with the two built-in test socket screws DIA 2 mm 0.079 in,
- Save time with our screwless component holder plug,
- Simplify the distribution between feed-through and disconnect circuits thanks to the two aligned jumper channels.

Ordering Details

Description	Color	Type	Catalog number	Packing pieces	Weight 1 pc (g)
Profile aligned with ZS4-SF, with 2 test socket screws DIA 2 mm 0.079 in., plug delivered separately	Grey	ZS4-SP-T2-R1	1SNK506314R0000	50	14.20

Main Technical Data

Connecting capacity	IEC	cULus - CSA
1 conductor per clamp	Rigid	0.2-4 mm ²
	Flexible	0.22-4 mm ²
	with non insulated ferrule	0.22-4 mm ²
	with insulated ferrule	0.22-4 mm ²
2 conductors per clamp	Gauge	A3-B3
	Rigid	0.2-1.5 mm ²
	Flexible	0.2-1.5 mm ²
	with twin ferrule	0.22-1.5 mm ²
Maximum cross section	4 mm ²	10 AWG
Max. current / Max. cross section	20 A	20 A
Rated short-time withstand current (1s)	480 A	
Rated voltage	400 V	150 V
Impulse withstand voltage	6000 V	
Protection	IP20	NEMA 1

Mounting Instructions

Rail		TH 35-7.5, TH 35-15
Wire stripping length		10.5 mm 0.413 in
Tool		Flat screwdriver ∅ 3.5 mm ∅ 0.138 in
Torque		0.6 Nm ± 0.1 5.31 lb.in ± 0.885

10

Accessories

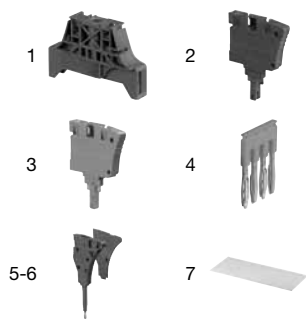

	Description	Color	Type	Catalog Number	Pack ^(ing) pieces	Weight (1 pce) g	
1	End Stops	Dark Grey	BAM3	1SNK900001R0000	50	13.80	
	Screw; 10mm 0.394 in						
2	Component Plugs	Dark Grey	PG5	1SNK900401R0000	20	3.45	
	Screwless; 5.2mm 0.205 in						
3	Disconnect Plugs	Orange	PG5-R1	1SNK900402R0000	20	3.45	
4	Jumper Bars	Orange	JB6-2	1SNK906302R0000	50	1.30	
							2 poles 41 A 30 A
							3 poles
							4 poles
							5 poles
10 poles							
5	Test Connectors	Dark Grey	TC5-R1	1SNK900201R0000	10	5.23	
6	Spacers	Dark Grey	ES-TC6	1SNK900105R0000	10	0.80	
7	Terminal Block Markers	White	MC612	1SNK150000R0000	22	10.00	
							Blank card
							Universal wire markers holder
	Self adhesive strip	Grey	UMH	1SNK900611R0000	10	0.20	
		White	SAT6	1SNK900615R0000	5	6.00	

Some accessories may modify the terminal block's ratings. See complete information in *Technical Datasheet*.

ZS4-S-R2 Screw clamp terminal blocks

Disconnect with lever

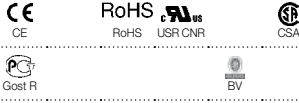

Technical Datasheet 1SNK 161 043 D0201

6 mm 0.236 in spacing

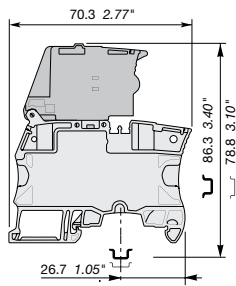
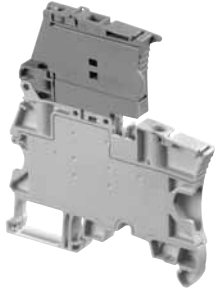

Features and Benefits

Simplify the disconnect operations for the disconnect terminal blocks installed next to fuse terminal blocks ZS4-SF:
 - With the same profile as ZS4-SF, the ZS4-S-R2 disconnect lever is easily operated by hand and the wiring of the alternated disconnect and fuse circuits is easier.

Ordering Details

Description	Color	Type	Catalog number	Packing pieces	Weight 1 pc (g)
Disconnect Profile aligned with ZS4-SF	Grey-Orange	ZS4-S-R2	1SNK506414R0000	50	21.60

Main Technical Data

Connecting capacity	IEC		cULus - CSA	
1 conductor per clamp	Rigid	0.2-4 mm ²	24-10 AWG	
	Flexible	0.22-4 mm ²	24-10 AWG	
	with non insulated ferrule	0.22-4 mm ²	24-12 AWG	
	with insulated ferrule	0.22-4 mm ²	24-12 AWG	
2 conductors per clamp	Gauge		A3-B3	
	Rigid	0.2-1.5 mm ²	24-16 AWG	
	Flexible	0.2-1.5 mm ²	24-16 AWG	
	with twin ferrule	0.22-1.5 mm ²	24-16 AWG	
Rated cross section	4 mm ²		10 AWG	
Rated current	22 A		13 A	
Rated short-time withstand current (1s)	480 A			
Rated voltage	400 V		150 V	
Impulse withstand voltage	6000 V			
Protection	IP20		NEMA 1	
Rated voltage Ex e	IEC/EN 60079-7			

Mounting Instructions

Rail		TH 35-7.5, TH 35-15
Wire stripping length		10.5 mm 0.413 in
Tool		Flat screwdriver Ø 3.5 mm Ø 0.138 in
Torque		0.6 Nm ± 0.1 5.31 lb.in ± 0.885

Accessories

Description	Color	Type	Catalog Number	Pack ^(ng) pieces	Weight (1 pce) g	
1 End Stops	Screw; 10mm 0.394 in	BAM3	1SNK90001R0000	50	13.80	
	Screwless; 5.2mm 0.205 in	BAZ1	1SNK900002R0000	50	5.30	
2 Jumper Bars	2 poles 41 A 30 A	JB6-2	1SNK906302R0000	50	1.30	
	3 poles	JB6-3	1SNK906303R0000	50	2.10	
	4 poles	JB6-4	1SNK906304R0000	50	2.90	
	5 poles	JB6-5	1SNK906305R0000	50	3.60	
	10 poles	JB6-10	1SNK906310R0000	20	7.40	
3 Test Adapters	For test plugs DIA 2 mm 0.079 in	TP2	1SNK900203R0000	20	1.73	
	For test plugs DIA 4 mm 0.160 in	TP4	1SNK900205R0000	20	2.42	
4 Test Connectors	End module, 5.2 mm 0.205 in	TC5-R1	1SNK900201R0000	10	5.23	
5 Spacers	0.8 mm 0.031 in spacing	ES-TC6	1SNK900105R0000	10	0.80	
6 Terminal Block Markers	Blank card	MC612	1SNK150000R0000	22	10.00	
		MC612PA	1SNK159999R0000	20	11.00	
	Universal wire markers holder	Grey	UMH	1SNK900611R0000	10	0.20
	Self adhesive strip	White	SAT6	1SNK900615 0000	5	6.00

Some accessories may modify the terminal block's ratings. See complete information in "Technical Datasheet".

Fuse Screw Clamp Terminal Blocks

Description	Color	Type	Catalog Number	Pack ^(ng) pieces	Weight (1 pce) g
	Grey-Dark Grey	ZS4-SF	1SNK506410R0000	50	18.60

Technical Datasheet 1SNK 161 002 D0201
 Catalogue Page 1SNK 161 002 S0201



ZS4-S-R3 Screw clamp terminal blocks

Disconnect with lever

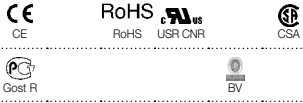

Technical Datasheet 1SNK 161 044 D0201

8 mm 0.315 in spacing

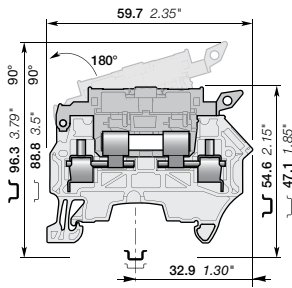
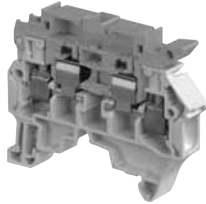

Features and Benefits

Simplify the disconnect operations for the disconnect terminal blocks installed next to fuse terminal blocks ZS4-SF1:
- With the same profile as ZS4-SF1, the ZS4-S-R3 disconnect lever is easily operated by hand and the wiring of the alternated disconnect and fuse circuits is easier.

Ordering Details

Description	Color	Type	Catalog number	Packing pieces	Weight 1 pc (g)
Disconnect Profile aligned with ZS4-SF1	Grey-Orange	ZS4-S-R3	1SNK508416R0000	50	13.30

Main Technical Data

Connecting capacity	IEC	cULus - CSA
1 conductor per clamp	Rigid	24-10 AWG
	Flexible	24-10 AWG
	with non insulated ferrule	24-12 AWG
	with insulated ferrule	24-12 AWG
2 conductors per clamp	Gauge	A3-B3
	Rigid	24-16 AWG
	Flexible	24-16 AWG
	with twin ferrule	24-16 AWG
Rated cross section	4 mm ²	10 AWG
Rated current	18 A	18 A
Rated short-time withstand current (1s)	480 A	
Rated voltage	500 V	300 V
Impulse withstand voltage	8000 V	
Protection	IP20	NEMA 1
Rated voltage Ex e	IEC/EN 60079-7	

Mounting Instructions

Rail		TH 35-7.5, TH 35-15
Wire stripping length		11 mm 0.433 in
Tool		Flat screwdriver Ø 3.5 mm Ø 0.138 in
Torque		0.6 Nm ± 0.1 5.31 lb.in ± 0.885

10

Accessories

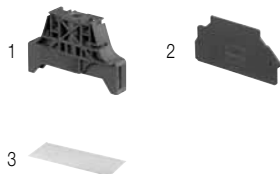

Description	Color	Type	Catalog Number	Pack ⁽ⁿ⁾ g pieces	Weight (1 pce) g
1 End Stops	Dark Grey	BAM3	1SNK900001R0000	50	13.80
	Dark Grey	BAZ1	1SNK900002R0000	50	5.30
2 End Sections	Dark Grey	ES4-SF	1SNK508960R0000	20	1.82
3 Terminal Block Markers	White	MC812	1SNK160000R0000	22	10.00
		MC812PA	1SNK169999R0000	20	14.00
	Grey	UMH	1SNK900611R0000	10	0.20
Self adhesive strip	White	SAT8	1SNK900616R0000	5	6.00

Some accessories may modify the terminal block's ratings. See complete information in "Technical Datasheet".

Fuse Screw Clamp Terminal Blocks

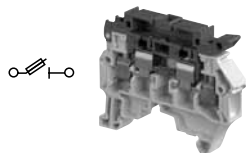

Description	Color	Type	Catalog Number	Pack ⁽ⁿ⁾ g pieces	Weight (1 pce) g
	Grey-Dark Grey	ZS4-SF1	1SNK508410R0000	50	13.30

Technical Datasheet 1SNK 161 002 D0201
Catalogue Page 1SNK 161 002 S0201

ZS4-SF Screw clamp terminal blocks for 5x20 fuses

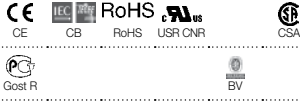

Technical Datasheet 1SNK 161 005 D0201

6 mm 0.236 in spacing

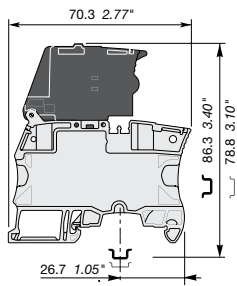

Features and Benefits

- Protect your circuits with 5x20 fuse terminal blocks compliant with IEC 60947-7-3 standard (fuse not supplied with the terminal blocks),
- Simplify the distribution thanks to the two jumper channels aligned with ZS4 feed-through and ZS4-S-R1 disconnect terminal blocks.

Ordering Details

Description	Color	Type	Catalog number	Packing pieces	Weight 1 pc (g)
	Grey-Dark Grey	ZS4-SF	1SNK506410R0000	50	18.60

Main Technical Data

Connecting capacity	IEC	cULus - CSA
1 conductor per clamp	Rigid	0.2-4 mm ²
	Flexible	0.22-4 mm ²
	with non insulated ferrule	0.22-4 mm ²
	with insulated ferrule	0.22-4 mm ²
	Gauge	A3-B3
2 conductors per clamp	Rigid	0.2-1.5 mm ²
	Flexible	0.2-1.5 mm ²
	with twin ferrule	0.22-1.5 mm ²
Rated cross section	4 mm ²	10 AWG
Rated current	6.3 A	6.3 A
Rated short-time withstand current (1s)	480 A	
Rated voltage	250 V	150 V
Impulse withstand voltage	6000 V	
Protection	IP20	NEMA 1
Rated power		
Separate arrangement/Overload and short-circuit protection	2.5 W	
Separate arrangement/Exclusive short-circuit protection	4 W	
Compound arrangement/Overload and short-circuit protection	2.5 W	
Compound arrangement/Exclusive short-circuit protection	4 W	

Mounting Instructions

Rail		TH 35-7.5, TH 35-15
Wire stripping length		10.5 mm 0.413 in
Tool		Flat screwdriver Ø 3.5 mm Ø 0.138 in
Torque		0.6 Nm ± 0.1 5.31 lb.in ± 0.885

Accessories

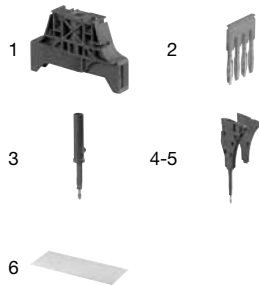

Description	Color	Type	Catalog number	Packing pieces	Weight 1 pc (g)	
1 End Stops	Screw; 10mm 0.394 in	BAM3	1SNK900001R0000	50	13.80	
	Screwless; 5.2mm 0.205 in	BAZ1	1SNK900002R0000	50	5.30	
2 Jumper Bars	2 poles 41 A 30 A	JB6-2	1SNK906302R0000	50	1.30	
	3 poles	JB6-3	1SNK906303R0000	50	2.10	
	4 poles	JB6-4	1SNK906304R0000	50	2.90	
	5 poles	JB6-5	1SNK906305R0000	50	3.60	
	10 poles	JB6-10	1SNK906310R0000	20	7.40	
3 Test Adapters	For test plugs DIA 2 mm 0.079 in	TP2	1SNK900203R0000	20	1.73	
	For test plugs DIA 4 mm 0.160 in	TP4	1SNK900205R0000	20	2.42	
4 Test Connectors	End module, 5.2 mm 0.205 in	TC5-R1	1SNK900201R0000	10	5.23	
5 Spacers	0.8 mm 0.031 in spacing	ES-TC6	1SNK900105R0000	10	0.80	
6 Terminal Block Markers	Blank card	MC612	1SNK150000R0000	22	10.00	
		MC612PA	1SNK159999R0000	20	11.00	
	Universal wire markers holder	Grey	UMH	1SNK900611R0000	10	0.20
	Self adhesive strip	White	SAT6	1SNK900615R0000	5	6.00

Some accessories may modify the terminal block's ratings. See complete information in "Technical Datasheet".

ZS4-SF-T Screw clamp terminal blocks for 5x20 fuses – with test socket screws



Technical Datasheet 1SNK 161 038 D0201

6 mm 0.236 in spacing

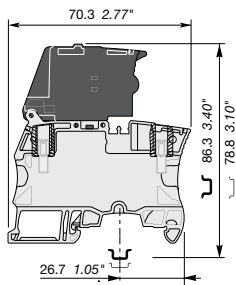

Features and Benefits

- Protect your circuits with 5x20 Fuse terminal blocks compliant with IEC 60947-7-3 standard (fuse not supplied with the terminal blocks),
- Simplify the distribution thanks to the two jumper channels aligned with ZS4 feed-through and ZS4-S-R1 disconnect terminal blocks,
- Ease the test with built-in test socket screws.

Ordering Details

Description	Color	Type	Catalog number	Packing pieces	Weight 1 pc (g)
With 2 test socket screws DIA 2 mm 0.079 in	Grey-Dark Grey	ZS4-SF-T2	1SNK506411R0000	50	18.60

Main Technical Data

Connecting capacity	IEC		cULus - CSA	
1 conductor per clamp	Rigid	0.2-4 mm ²	24-10 AWG	
	Flexible	0.22-4 mm ²	24-10 AWG	
	with non insulated ferrule	0.22-4 mm ²	24-12 AWG	
	with insulated ferrule	0.22-4 mm ²	24-12 AWG	
	Gauge		A3-B3	
2 conductors per clamp	Rigid	0.2-1.5 mm ²	24-16 AWG	
	Flexible	0.2-1.5 mm ²	24-16 AWG	
	with twin ferrule	0.22-1.5 mm ²	24-16 AWG	
Rated cross section		4 mm ²	10 AWG	
Rated current		6.3 A	6.3 A	
Rated short-time withstand current (1s)		480 A		
Rated voltage		250 V	150 V	
Impulse withstand voltage		6000 V		
Protection		IP20	NEMA 1	
Rated power				
Separate arrangement/Overload and short-circuit protection		2.5 W		
Separate arrangement/Exclusive short-circuit protection		4 W		
Compound arrangement/Overload and short-circuit protection		2.5 W		
Compound arrangement/Exclusive short-circuit protection		4 W		

Mounting Instructions

Rail		TH 35-7.5, TH 35-15
Wire stripping length		10.5 mm 0.413 in
Tool		Flat screwdriver Ø 3.5 mm Ø 0.138 in
Torque		0.6 Nm ± 0.1 5.31 lb.in ± 0.885

10

Accessories

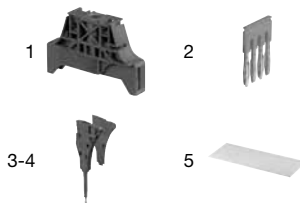

Description	Color	Type	Catalog number	Packing pieces	Weight 1 pc (g)			
1 End Stops	Dark Grey	BAM3	1SNK900001R0000	50	13.80			
	Dark Grey	BAZ1	1SNK900002R0000	50	5.30			
2 Jumper Bars	Orange	2 poles	41 A	30 A	JB6-2	1SNK906302R0000	50	1.30
		3 poles			JB6-3	1SNK906303R0000	50	2.10
		4 poles			JB6-4	1SNK906304R0000	50	2.90
		5 poles			JB6-5	1SNK906305R0000	50	3.60
		10 poles			JB6-10	1SNK906310R0000	20	7.40
3 Test Connectors	Dark Grey	TC5-R1	1SNK900201R0000	10	5.23			
4 Spacers	Dark Grey	ES-TC6	1SNK900105R0000	10	0.80			
5 Terminal Block Markers	White	MC612	1SNK150000R0000	22	10.00			
		MC612PA	1SNK159999R0000	20	11.00			
	Grey	UMH	1SNK900611R0000	10	0.20			
	White	SAT6	1SNK900615R0000	5	6.00			

Some accessories may modify the terminal block's ratings. See complete information in "Technical Datasheet".

ZS4-SF-R Screw clamp terminal blocks for 5x20 fuses – with blown fuse indicator



Technical Datasheet 1SNK 161 006 D0201

6 mm 0.236 in spacing

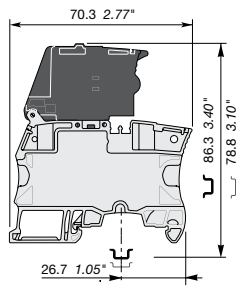

Features and Benefits

- Protect your circuits with 5x20 fuse terminal blocks compliant with IEC 60947-7-3 standard (fuse not supplied with the terminal blocks),
- Simplify the distribution thanks to the two jumper channels aligned with ZS4 feed-through and ZS4-S-R1 disconnect terminal blocks,
- Quickly identify the defective circuit thanks to the blown fuse indicator (with leakage current < 0.5 mA).

Ordering Details

Description	Color	Type	Catalog Number	Packing pieces	Weight 1 pc (g)
With blown fuse indicator by red LED 24-60V	Grey-Dark Grey	ZS4-SF-R1	1SNK506412R0000	50	18.60
With blown fuse indicator by red LED 115-250V	Grey-Dark Grey	ZS4-SF-R3	1SNK506415R0000	50	18.60

Main Technical Data

Connecting capacity	IEC	cULus - CSA
1 conductor per clamp	Rigid	0.2-4 mm ²
	Flexible	0.22-4 mm ²
	with non insulated ferrule	0.22-4 mm ²
	with insulated ferrule	0.22-4 mm ²
2 conductors per clamp	Gauge	A3-B3
	Rigid	0.2-1.5 mm ²
	Flexible	0.2-1.5 mm ²
	with twin ferrule	0.22-1.5 mm ²
Rated cross section	4 mm ²	10 AWG
Rated current	6.3 A	6.3 A
Rated short-time withstand current (1s)	480 A	
Rated voltage	250 V	150 V
Impulse withstand voltage	6000 V	
Protection	IP20	NEMA 1
Rated power		
Separate arrangement/Overload and short-circuit protection	2.5 W	
Separate arrangement/Exclusive short-circuit protection	4 W	
Compound arrangement/Overload and short-circuit protection	2.5 W	
Compound arrangement/Exclusive short-circuit protection	4 W	

Mounting Instructions

Rail		TH 35-7.5, TH 35-15
Wire stripping length		10.5 mm 0.413 in
Tool		Flat screwdriver Ø 3.5 mm Ø 0.138 in
Torque		0.6 Nm ± 0.1 5.31 lb.in ± 0.885

Accessories

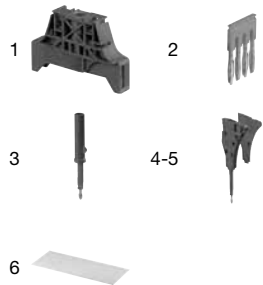

Description	Color	Type	Catalog Number	Pack(ing) pieces	Weight (1pc) g
1 End Stops	Screw; 10mm 0.394 in	BAM3	1SNK900001R0000	50	13.80
	Screwless; 5.2mm 0.205 in	BAZ1	1SNK900002R0000	50	5.30
2 Jumper Bars	2 poles 41 A 30 A	JB6-2	1SNK906302R0000	50	1.30
	3 poles	JB6-3	1SNK906303R0000	50	2.10
	4 poles	JB6-4	1SNK906304R0000	50	2.90
	5 poles	JB6-5	1SNK906305R0000	50	3.60
	10 poles	JB6-10	1SNK906310R0000	20	7.40
3 Test Adapters	For test plugs DIA 2 mm 0.079 in	TP2	1SNK900203R0000	20	1.73
	For test plugs DIA 4 mm 0.160 in	TP4	1SNK900205R0000	20	2.42
4 Test Connectors	End module, 5.2 mm 0.205 in	TC5-R1	1SNK900201R0000	10	5.23
5 Spacers	0.8 mm 0.031 in spacing	ES-TC6	1SNK900105R0000	10	0.80
6 Terminal Block Markers	Blank card	MC612	1SNK150000R0000	22	10.00
		MC612PA	1SNK159999R0000	20	11.00
	Universal wire markers holder	UMH	1SNK900611R0000	10	0.20
	Self adhesive strip	SAT6	1SNK900615R0000	5	6.00

Some accessories may modify the terminal block's ratings. See complete information in "Technical Datasheet".

ZS4-SF-R Screw clamp terminal blocks

for 5x20 fuses – with blown fuse indicator & test socket screws



Technical Datasheet 1SNK 161 037 D0201

6 mm 0.236 in spacing

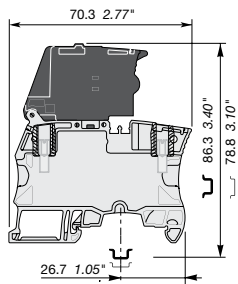
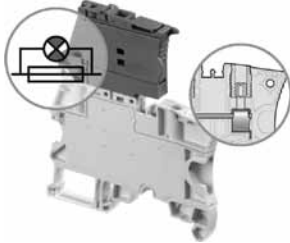

Features and Benefits

- Protect your circuits with 5x20 fuse terminal blocks compliant with IEC 60947-7-3 standard (fuse not supplied with the terminal blocks),
- Simplify the distribution thanks to the two jumper channels aligned with ZS4 feed-through and ZS4-S-R1 disconnect terminal blocks,
- Ease the test with built-in test socket screws,
- Quickly identify the defective circuit thanks to the blown fuse indicator (with leakage current < 0.5 mA).

Ordering Details

Description	Color	Type	Catalog Number	Packing pieces	Weight 1 pc (g)
With blown fuse indicator by red LED 24-60V and 2 test socket screws DIA 2 mm 0.079 in	Grey-Dark Grey	ZS4-SF-R2	1SNK506413R0000	50	18.60
With blown fuse indicator by red LED 115-250V and 2 test socket screws DIA 2 mm 0.079 in	Grey-Dark Grey	ZS4-SF-R4	1SNK506416R0000	50	18.60

Main Technical Data

Connecting capacity	IEC	cULus - CSA
1 conductor per clamp	Rigid	0.2-4 mm ²
	Flexible	0.22-4 mm ²
	with non insulated ferrule	0.22-4 mm ²
	with insulated ferrule	0.22-4 mm ²
	Gauge	A3-B3
2 conductors per clamp	Rigid	0.2-1.5 mm ²
	Flexible	0.2-1.5 mm ²
	with twin ferrule	0.22-1.5 mm ²
Rated cross section	4 mm ²	10 AWG
Rated current	6.3 A	6.3 A
Rated short-time withstand current (1s)	480 A	
Rated voltage	250 V	150 V
Impulse withstand voltage	6000 V	
Protection	IP20	NEMA 1
Rated power		
Separate arrangement/Overload and short-circuit protection	2.5 W	
Separate arrangement/Exclusive short-circuit protection	4 W	
Compound arrangement/Overload and short-circuit protection	2.5 W	
Compound arrangement/Exclusive short-circuit protection	4 W	

Mounting Instructions

Rail		TH 35-7,5, TH 35-15
Wire stripping length		10.5 mm 0.413 in
Tool		Flat screwdriver Ø 3.5 mm Ø 0.138 in
Torque		0.6 Nm ± 0.1 5.31 lb.in ± 0.885

10

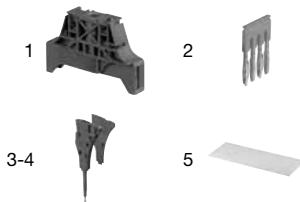

Accessories

Description	Color	Type	Catalog Number	Packing pieces	Weight 1 pc (g)	
1 End Stops	Screw; 10mm 0.394 in	BAM3	1SNK900001R0000	50	13.80	
	Screwless; 5.2mm 0.205 in	BAZ1	1SNK900002R0000	50	5.30	
2 Jumper Bars	2 poles 41 A 30 A	JB6-2	1SNK906302R0000	50	1.30	
	3 poles	JB6-3	1SNK906303R0000	50	2.10	
	4 poles	JB6-4	1SNK906304R0000	50	2.90	
	5 poles	JB6-5	1SNK906305R0000	50	3.60	
	10 poles	JB6-10	1SNK906310R0000	20	7.40	
	3 Test Connectors	End module, 5.2 mm 0.205 in	TC5-R1	1SNK900201R0000	10	5.23
4 Spacers	0.8 mm 0.031 in spacing	ES-TC6	1SNK900105R0000	10	0.80	
5 Terminal Block Markers	Blank card	White	MC612	1SNK150000R0000	22	10.00
			MC612PA	1SNK159999R0000	20	11.00
	Universal wire markers holder	Grey	UMH	1SNK900611R0000	10	0.20
	Self adhesive strip	White	SAT6	1SNK900615R0000	5	6.00

Some accessories may modify the terminal block's ratings. See complete information in "Technical Datasheet".

ZS4-SF1 Screw clamp terminal blocks for 5x20 & 5x25 fuses

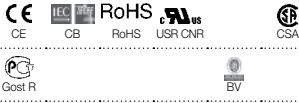

Features and Benefits

- Protect your circuit with 5x25 and 5x20 fuse terminal blocks, compliant with IEC 60947-7-3 standard (fuse not supplied with the terminal blocks).

Ordering Details

Technical Datasheet 1SNK 161 011 D0201

8 mm 0.315 in spacing

Description	Color	Type	Catalog Number	Packing pieces	Weight 1 pc (g)
	Grey-Dark Grey	ZS4-SF1	1SNK508410R0000	50	13.30

Main Technical Data

Connecting capacity	IEC	cULus - CSA
1 conductor per clamp	Rigid	0.2-4 mm ²
	Flexible	0.22-4 mm ²
	with non insulated ferrule	0.22-4 mm ²
	with insulated ferrule	0.22-4 mm ²
Gauge	A3-B3	
2 conductors per clamp	Rigid	0.2-1.5 mm ²
	Flexible	0.2-1.5 mm ²
	with twin ferrule	0.22-1.5 mm ²
Rated cross section	4 mm ²	10 AWG
Rated current	6.3 A	6.3 A
Rated short-time withstand current (1s)	480 A	
Rated voltage	250 V	300 V
Impulse withstand voltage	8000 V	
Protection	IP20	NEMA 1
Rated power		
Separate arrangement/Overload and short-circuit protection	2.5 W	
Separate arrangement/Exclusive short-circuit protection	4 W	
Compound arrangement/Overload and short-circuit protection	1.6 W	
Compound arrangement/Exclusive short-circuit protection	4 W	

Mounting Instructions

Rail		TH 35-7.5, TH 35-15
Wire stripping length		11 mm 0.433 in
Tool		Flat screwdriver Ø 3.5 mm Ø 0.138 in
Torque		0.6 Nm ± 0.1 5.31 lb.in ± 0.885

10

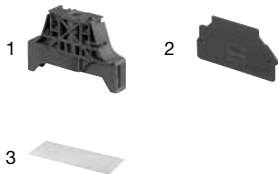
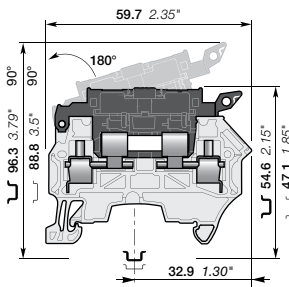
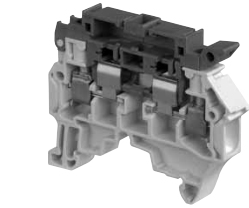

Accessories

Description	Color	Type	Catalog Number	Pack(ing) pieces	Weight (1 pc) g
1 End Stops	Screw; 10mm 0.394 in	BAM3	1SNK900001R0000	50	13.80
	Screwless; 5.2mm 0.205 in	BAZ1	1SNK900002R0000	50	5.30
2 End Sections	1.5 mm 0.059 in	ES4-SF	1SNK508960R0000	20	1.82
3 Terminal Block Markers Blank card		MC812	1SNK160000R0000	22	10.00
		MC812PA	1SNK169999R0000	20	14.00
	Universal wire markers holder	Grey	UMH	1SNK900611R0000	10
Self adhesive strip	White	SAT8	1SNK900616R0000	5	6.00

Some accessories may modify the terminal block's ratings. See complete information in "Technical Datasheet".

ZS4-SF1-T Screw clamp terminal blocks for 5x20 & 5x25 fuses – with test socket screws



Technical Datasheet 1SNK 161 036 D0201

8 mm 0.315 in spacing

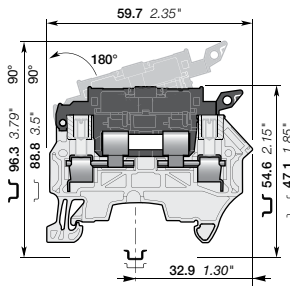
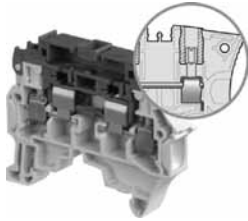

Features and Benefits

- Protect your circuit with 5x25 and 5x20 fuse terminal blocks (fuse not supplied with the terminal blocks),
- Compliant with IEC 60947-7-3 standard,
- With built in test socket screws.

Ordering Details

Description	Color	Type	Catalog Number	Packing pieces	Weight 1 pc (g)
With 2 test socket screws DIA 2 mm 0.079 in	Grey-Dark Grey	ZS4-SF1-T2	1SNK508411R0000	50	13.30

Main Technical Data

Connecting capacity	IEC	dULus - CSA
1 conductor per clamp	Rigid	0.2-4 mm ²
	Flexible	0.22-4 mm ²
	with non insulated ferrule	0.22-4 mm ²
	with insulated ferrule	0.22-4 mm ²
2 conductors per clamp	Gauge	A3-B3
	Rigid	0.2-1.5 mm ²
	Flexible	0.2-1.5 mm ²
	with twin ferrule	0.22-1.5 mm ²
Rated cross section	4 mm ²	10 AWG
Rated current	6.3 A	6.3 A
Rated short-time withstand current (1s)	480 A	
Rated voltage	250 V	300 V
Impulse withstand voltage	8000 V	
Protection	IP20	NEMA 1
Rated power		
Separate arrangement/Overload and short-circuit protection	2.5 W	
Separate arrangement/Exclusive short-circuit protection	4 W	
Compound arrangement/Overload and short-circuit protection	1.6 W	
Compound arrangement/Exclusive short-circuit protection	4 W	

Mounting Instructions

Rail		TH 35-7.5, TH 35-15
Wire stripping length		11 mm 0.433 in
Tool		Flat screwdriver Ø 3.5 mm Ø 0.138 in
Torque		0.6 Nm ± 0.1 5.31 lb.in ± 0.885

10

Accessories

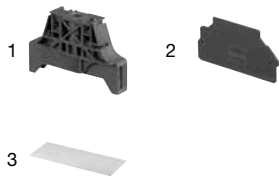

Description	Color	Type	Catalog Number	Pack ^{ing} pieces	Weight (1 pc)
1 Ed Stops	Dark Grey	BAM3	1SNK900001R0000	50	13.80
	Dark Grey	BAZ1	1SNK900002R0000	50	5.30
2 End Sections	Dark Grey	ES4-SF	1SNK508960R0000	20	1.82
3 Terminal Block Markers	White	MC812	1SNK160000R0000	22	10.00
	White	MC812PA	1SNK169999R0000	20	14.00
	Grey	UMH	1SNK900611R0000	10	0.20
Self adhesive strip	White	SAT8	1SNK900616R0000	5	6.00

Some accessories may modify the terminal block's ratings. See complete information in "Technical Datasheet".

ZS4-SF1-R Screw clamp terminal blocks for 5x20 & 5x25 fuses – with blown fuse indicator

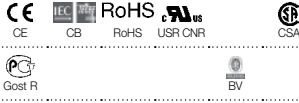

Technical Datasheet 1SNK 161 034 D0201

8 mm 0.315 in spacing

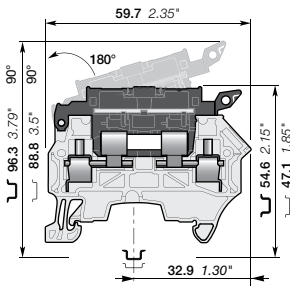
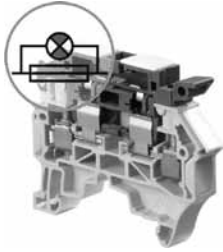

Features and Benefits

- Protect your circuit with 5x25 and 5x20 fuse terminal blocks (fuse not supplied with the terminal blocks),
- Compliant with IEC 60947-7-3 standard,
- Quickly identify the defective circuit thanks to the blown fuse indicator (with leakage current < 0.5 mA).

Ordering Details

Description	Color	Type	Catalog Number	Packing pieces	Weight 1 pc (g)
With blown fuse indicator by red LED 24-60V	Grey-Dark Grey	ZS4-SF1-R1	1SNK508412R0000	50	13.30
With blown fuse indicator by red LED 115-250V	Grey-Dark Grey	ZS4-SF1-R3	1SNK508414R0000	50	13.30

Main Technical Data

Connecting capacity	IEC		cULus - CSA		Rail	Wire stripping length	TH 35-7.5, TH 35-15
	Rigid	Flexible					
1 conductor per clamp	Rigid	0.2-4 mm ²	24-10 AWG		A3-B3	11 mm 0.433 in	
	Flexible	0.22-4 mm ²	24-10 AWG				
	with non insulated ferrule	0.22-4 mm ²	24-12 AWG				
	with insulated ferrule	0.22-4 mm ²	24-12 AWG				
2 conductors per clamp	Rigid	0.2-1.5 mm ²	24-16 AWG		Tool	Flat screwdriver Ø 3.5 mm Ø 0.138 in	
	Flexible	0.2-1.5 mm ²	24-16 AWG				
	with twin ferrule	0.22-1.5 mm ²	24-16 AWG				
Rated cross section	4 mm ²		10 AWG		Torque	0.6 Nm ± 0.1 5.31 lb.in ± 0.885	
Rated current	6.3 A		6.3 A				
Rated short-time withstand current (1s)	480 A						
Rated voltage	250 V		300 V				
Impulse withstand voltage	8000 V						
Protection	IP20		NEMA 1				
Rated power							
Separate arrangement/Overload and short-circuit protection	2.5 W						
Separate arrangement/Exclusive short-circuit protection	4 W						
Compound arrangement/Overload and short-circuit protection	1.6 W						
Compound arrangement/Exclusive short-circuit protection	4 W						

Mounting Instructions

Rail	Wire stripping length	Tool	Torque
TH 35-7.5, TH 35-15	11 mm 0.433 in	Flat screwdriver Ø 3.5 mm Ø 0.138 in	0.6 Nm ± 0.1 5.31 lb.in ± 0.885

10

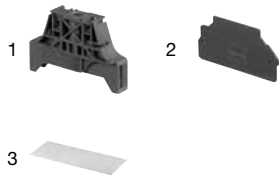

Accessories

Description	Color	Type	Catalog Number	Pack(ing) pieces	Weight 1pc (g)
1 End Stops	Dark Grey	BAM3	1SNK900001R0000	50	13.80
	Dark Grey	BAZ1	1SNK900002R0000	50	5.30
2 End Sections	Dark Grey	ES4-SF	1SNK508960R0000	20	1.82
3 Terminal Block Markers	White	MC812	1SNK160000R0000	22	10.00
	White	MC812PA	1SNK169999R0000	20	14.00
	Grey	UMH	1SNK900611R0000	10	0.20
	White	SAT8	1SNK900616R0000	5	6.00

Some accessories may modify the terminal block's ratings. See complete information in "Technical Datasheet".

ZS4-SF1-R Screw clamp terminal blocks for 5x20 & 5x25 fuses with blown fuse indicator & test socket screws

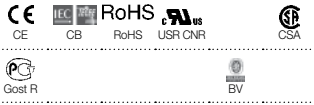

Features and Benefits

- Protect your circuit with 5x25 and 5x20 fuse terminal blocks (fuse not supplied with the terminal blocks),
- Compliant with IEC 60947-7-3 standard,
- Ease the test with built-in test socket screws,
- Quickly identify the defective circuit thanks to the blown fuse indicator (with leakage current < 0.5 mA).

Ordering Details

Description	Color	Type	Catalog Number	Packing pieces	Weight 1 pc (g)
With blown fuse indicator by red LED 24-60V and 2 test socket screws DIA 2 mm 0.079 in	Grey-Dark Grey	ZS4-SF1-R2	1SNK508413R0000	50	13.30
With blown fuse indicator by red LED 115-250V and 2 test socket screws DIA 2 mm 0.079 in	Grey-Dark Grey	ZS4-SF1-R4	1SNK508415R0000	50	13.30

8 mm 0.315 in spacing

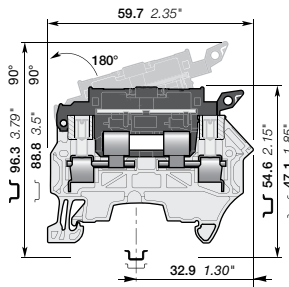
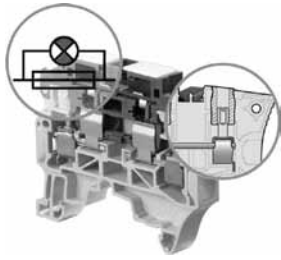

Main Technical Data

Connecting capacity	IEC	cULus - CSA
1 conductor per clamp	Rigid	0.2-4 mm ²
	Flexible	0.22-4 mm ²
	with non insulated ferrule	0.22-4 mm ²
	with insulated ferrule	0.22-4 mm ²
Gauge	A3-B3	
2 conductors per clamp	Rigid	0.2-1.5 mm ²
	Flexible	0.2-1.5 mm ²
	with twin ferrule	0.22-1.5 mm ²
Rated cross section	4 mm ²	10 AWG
Rated current	6.3 A	6.3 A
Rated short-time withstand current (1s)	480 A	
Rated voltage	250 V	300 V
Impulse withstand voltage	8000 V	
Protection	IP20	NEMA 1
Rated power		
Separate arrangement/Overload and short-circuit protection	2.5 W	
Separate arrangement/Exclusive short-circuit protection	4 W	
Compound arrangement/Overload and short-circuit protection	1.6 W	
Compound arrangement/Exclusive short-circuit protection	4 W	

Mounting Instructions

Rail		TH 35-7.5, TH 35-15
Wire stripping length		11 mm 0.433 in
Tool		Flat screwdriver Ø 3.5 mm Ø 0.138 in
Torque		0.6 Nm ± 0.1 5.31 lb.in ± 0.885

10

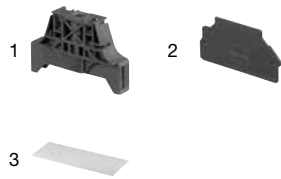

Accessories

Description	Color	Type	Catalog Number	Pack ^(ing) pieces	Weight (1 pce) g
1 End Stops		Screw; 10mm 0.394 in	BAM3	1SNK900001R0000	50 13.80
		Screwless; 5.2mm 0.205 in	BAZ1	1SNK900002R0000	50 5.30
2 End Sections	Dark Grey	1.5 mm 0.059 in	ES4-SF	1SNK508960R0000	20 1.82
3 Terminal Block Markers	White	Blank card	MC812	1SNK160000R0000	22 10.00
		Universal wire markers holder	MC812PA	1SNK169999R0000	20 14.00
	Grey		UMH	1SNK900611R0000	10 0.20
	White		SATB	1SNK900616R0000	5 6.00

Some accessories may modify the terminal block's ratings. See complete information in "Technical Datasheet".

PR30 Mounting rail

Terminal block accessories

RoHS
RoHS

2000 mm 78 in Length

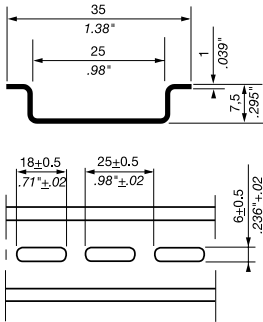

Features and Benefits

- Pre-punched symmetrical mounting rail;
- The oblong holes ease the mounting and allow to use existing and/or numerous fixings;
- Particularly well designed for fixing onto back-plates and for terminal assemblies of small dimensions

Ordering Details

Description	Color	Type	Catalog Number	Packing pieces	Weight 1 pc (g)
Prepunched rail		PR30	017322005	20	

Main Technical Data

Material	Zinc plating and passivation steel		
Rail			
	IEC	cULus - CSA	
Equivalent E-Cu cross section			

Mounting Instructions

- In order to guarantee the performances and security of your installation, please ensure the rail and its fixings can withstand the static and dynamic loads of the components mounted on it;
- To prevent the rail from flexing (1 mm 0.039 in rail thickness only), fixing is recommended every 250 mm 9.842 in;
- To prevent any issues during mounting, screw heads used for rail fixing should not protrude from the rail (7,5 mm 0.295 in rail height only).

PR3.Z2 Mounting rail

Terminal block accessories

RoHS
RoHS

2000 mm 78 in Length

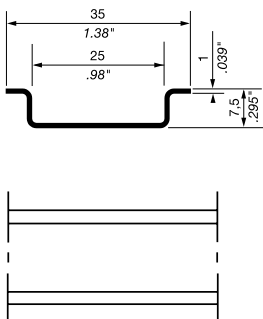

Features and Benefits

- Symmetrical mounting rail complying with IEC60715;
- Particularly well designed for fixing onto back-plates and for terminal assemblies of small dimensions

Ordering Details

Description	Color	Type	Catalog Number	Packing pieces	Weight 1 pc (g)
		PR3.Z2	017430017	20	

Main Technical Data

Material	Zinc plating and passivation steel		
Rail	TH 35-7.5		
	IEC	cULus - CSA	
Equivalent E-Cu cross section	16 mm ²	4 AWG	

Mounting Instructions

- In order to guarantee the performances and security of your installation, please ensure the rail and its fixings can withstand the static and dynamic loads of the components mounted on it;
- To prevent the rail from flexing (1 mm 0.039 in rail thickness only), fixing is recommended every 250 mm 9.842 in;
- To prevent any issues during mounting, screw heads used for rail fixing should not protrude from the rail (7,5 mm 0.295 in rail height only).

PR50 Mounting rail

Terminal block accessories

RoHS
RoHS

2000 mm 78 in Length

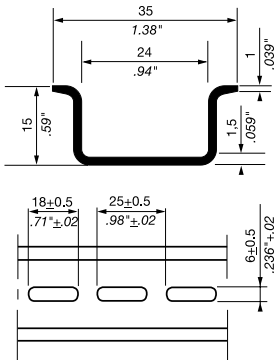

Features and Benefits

- Pre-punched symmetrical mounting rail;
- The oblong holes ease the mounting and allow to use existing and/or numerous fixings.

Ordering Details

Description	Color	Type	Catalog Number	Packing pieces	Weight 1 pc (g)
Prepunched rail		PR50	010159826	10	

Main Technical Data

Material	Zinc plating and passivation steel	
Rail		
	IEC	cULus - CSA
Equivalent E-Cu cross section		

Mounting Instructions

- In order to guarantee the performances and security of your installation, please ensure the rail and its fixings can withstand the static and dynamic loads of the components mounted on it;
- To prevent the rail from flexing, fixing is recommended every 500 mm 19.685 in;
- In order to increase the accessibility of your terminal assembly, we recommend the use of our rail offset brackets EM45 (Catalog Number 1SNA 008 521 R2600) for a 45° orientation of the rail.

10

PR5 Mounting rail

Terminal block accessories

RoHS
RoHS

2000 mm 78 in Length

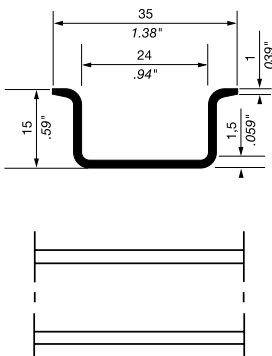

Features and Benefits

- Symmetrical mounting rail

Ordering Details

Description	Color	Type	Catalog Number	Packing pieces	Weight 1 pc (g)
		PR5	016870022	10	

Main Technical Data

Material	Zinc plating and passivation steel	
Rail		
	IEC	cULus - CSA
Equivalent E-Cu cross section		

Mounting Instructions

- In order to guarantee the performances and security of your installation, please ensure the rail and its fixings can withstand the static and dynamic loads of the components mounted on it;
- To prevent the rail from flexing, fixing is recommended every 500 mm 19.685 in;
- In order to increase the accessibility of your terminal assembly, we recommend the use of our rail offset brackets EM45 (Catalog Number 1SNA 008 521 R2600) for a 45° orientation of the rail.

PR4 Mounting rail

Terminal block accessories

RoHS
RoHS

2000 mm 78 in Length

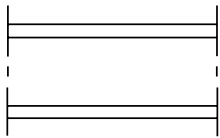
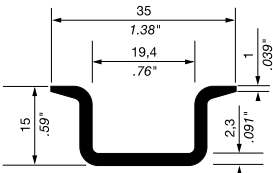

Features and Benefits

- Symmetrical mounting rail complying with IEC60715;
- The rigidity of the rail is maximised by the 2.3 mm 0.090 in thickness of the rail, and by its solid, non slotted construction
- PR4 TH35-15 is the most rigid mounting rail solution and it can support any electrical devices.

Ordering Details

Description	Color	Type	Catalog Number	Packing pieces	Weight 1 pc (g)
Recommended for SNK ground terminal blocks up to 35 mm ² 2 AWG.		PR4	016850012	10	

Main Technical Data

Material	Zinc plating and passivation steel		
Rail	TH 35-15		
	IEC	cULus - CSA	
Equivalent E-Cu cross section	50 mm ²	0 AWG	

Mounting Instructions

- In order to guarantee the performances and security of your installation, please ensure the rail and its fixings can withstand the static and dynamic loads of the components mounted on it;
- To prevent the rail from flexing, fixing is recommended every 700 mm 27.559 in;
- In order to increase the accessibility of your terminal assembly, we recommend the use of our rail offset brackets EM45 (Catalog Number 1SNA 008 521 R2600) for a 45° orientation of the rail.

10

AMS 500 Marking table Marking system

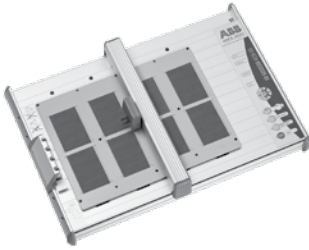

AMS 500

Features and Benefits

- Easy to use
- Compatible with most markers on the market
- Many possible character sizes.

Ordering Details

Description	Color	Type	Catalog Number	Packing pieces	Weight 1 pc (g)
Full kit including: 1 marking table 1 power supply cable, 1 USB cable, 1 software		AMS 500	XUSP02636	1	12600
1 support plate for 8 cards RC/MC/RCTT/WMTT/BA4/RCT - Full format		SPRC 1	XUSP02633	1	220
1 plotter pen Ø 0.25 mm .01 in	White	AMS PEN 0.25	XUSP01132	1	
1 plotter pen Ø 0.35 mm .014 in	Yellow	AMS PEN 0.35	XUSP01133	1	
5 ink cartridges		AMS INK CARTRIDGES	XUSP01134	1	
1 cleaner fluid		AMS CLEANER FLUID	XUSP01135	1	
1 cleaner kit		AMS CLEANER KIT	XUSP01139	1	



Support plates for ABB markers

Description	Color	Type	Catalog Number	Packing pieces	Weight 1 pc (g)
Support plates for RC/MC/RCTT/WMTT/BA4/RCT Full format		SPRC 1	XUSP02633	1	220
RB strips		SPRC 4	XUSP01550	1	
RTM7-9		SPRC 5	XUSP01138	1	
PIB		SPRC 13	XUSP02639	1	
BA5-50		SPRC 14	XUSP02640	1	
MC... PA (3 cards)		SPRC 30	XUSP03457	1	
A4 universal support plate		SPRC 21	XUSP02695	1	851



SPRC 21

Other available accessories

Description	Packaging	Catalog number
Ink cartridges (5)	1	XUSP01134
Plotter pen ink (30 ml bottle)	1	XUSP02530
Cleaning cartridge (2)	1	XUSP01135
Plotter pen cleaning fluid (50 ml bottle)	1	XUSP02531
Cleaner waste bottle	1	XUSP01139
Plotter pen (.18mm)	1	XUSP01551
Plotter pen (.25mm)	1	XUSP01132
Plotter pen (.35mm)	1	XUSP01133
Plotter pen (.50mm)	1	XUSP01552
Plotter pen (.70mm)	1	XUSP01548
Plotter pen (1.00mm)	1	XUSP01549
Disposable pen ED ink - Black (.18mm)	1	XUSP03511
Disposable pen ED ink - Blue (.18mm)	1	XUSP03512
Disposable pen ED ink - Red (.18mm)	1	XUSP03513
Disposable pen ED ink - Green (.18mm)	1	XUSP03514
Disposable pen ED ink - Black (.25mm)	1	XUSP03342
Disposable pen ED ink - Blue (.25mm)	1	XUSP03343
Disposable pen ED ink - Red (.25mm)	1	XUSP03344
Disposable pen ED ink - Green (.25mm)	1	XUSP03345
Disposable pen ED ink - Black (.35mm)	1	XUSP03346
Disposable pen ED ink - Blue (.35mm)	1	XUSP03347
Disposable pen ED ink - Red (.35mm)	1	XUSP03348
Disposable pen ED ink - Green (.35mm)	1	XUSP03349
Pen adaptor for permanent marker	1	XUSP03221
RC/RCT template (8 cards)	1	XUSP02633
RTM 7/9 template	1	XUSP01138
RPB-12 template (PCB strips)	1	XUSP01550
Pads for RC/RCT template	1	XUSP02629
Pads for RTM template	1	XUSP02630
Service kit for pen maintenance	1	XUSP02861

Plotter accessories:



Marking systems

HTP500 thermal transfer printer



HTP500

Description

- Excellent print quality, resolution: 300 dpi
- Fast printing: up to 5,000 markers per hour
- Excellent marking durability
- Ease and flexibility of use in automatic, semi-automatic or manual mode



HTP500-FEED



HTP500-FEED



HTP500-PL2



RIB-B



HTP500

Ordering details

Description	Type	Package	Catalog number
Full kit including:	HTP500 KIT	-	1SNA235700R1500
- 1 HTP500 thermal transfer printer	HTP500	-	-
- software for HTP500 thermal transfer printer	HTS500	1	1SNA235702R0300
- support table	HTP500-BAS	1	1SNA235706R0700
- universal feeder for marker cards	HTP500-FEED	1	1SNA235703R0400
- support plate for ABB terminal block markers	HTP500-PL2	1	1SNA235705R0600
- universal support plate for wire markers	HTP500-PL	1	1SNA235704R0500
- black ribbon cassette	RIB-B	3	1SNA235710R0600
- cleaning cassette	HTP500-CLEAN	1	1SNA235714R2600
- power supply cable	HTP500-PW	1	1SNA235709R1200
- parallel cable	HTP500-LPT	1	1SNA235708R1100
- USB/parallel adapter cable	HTP500-USB	1	1SNA235719R0300
- wooden box for HTP500 kit	HTP500-WB	1	1SNA235717R2100

Feeders and support plates

Description	Type	Package	Catalog number
Universal feeder for marker cards	HTP500-FEED	1	1SNA235703R0400
Support plate for ABB terminal block markers	HTP500-PL2	1	1SNA235705R0600

Accessories

Description	Type	Package	Catalog number
Black ribbon cassette	RIB-B	3	1SNA235710R0600
Red ribbon cassette for identification plates and adhesive labels	RIB-R	3	1SNA235711R2300
Red ribbon cassette for terminal blocks and wire markers	RIB-RS	3	1SNA235718R0200
Cleaning cassette	HTP500-CLEAN	1	1SNA235714R2600
Standard cleaning roll ø18	HTP500-ROLL	1	1SNA235715R2700
Printing head	HTP500-PRINT	1	1SNA235716R2000
Power supply cable	HTP500-PW	1	1SNA235709R1200
Parallel cable	HTP500-LPT	1	1SNA235708R1100
USB/parallel adapter cable	HTP500-USB	1	1SNA235719R0300
Dust cover for HTP500 and AMS 500 systems	DUST COVER	1	1SNA360161R1500
Wooden box for HTP500 kit	HTP500-WB	1	1SNA235717R2100

MC512 Terminal block markers

Blank card in polycarbonate

5.2 mm 0.205 in spacing



AMS 500



HTP500

Features and Benefits

- MC512 marker card in polycarbonate for high marking quality and durability.
- Excellent marking durability in the most severe environments,
- Improved marking visibility thanks to the increased marking surface +20% (12 mm 0.472 in)

Ordering Details

Description	Number of markers per unit	Color	Type	Catalog Number	Packing pieces	Weight 1 pc (g)
Blank card	45	White	MC512	1SNK140000R0000	22	9.00
		Yellow	MC512-YL	1SNK140004R0000	22	9.00

Main Technical Data

Material	Flammability	Maximum printed digits				Dimensions	
		Horizontal	3	Vertical	8	mm	inches
Polycarbonate	V0	Horizontal	3	Vertical	8	4.8 x 12	0.189 x 0.472

Marking Systems

Description	Type	Catalog Number	Packing pieces	Weight 1 pc (g)
Marking table	AMS 500 KIT	XUSP02636	1	12600.00
Thermal transfer printer	HTP500	1SNA235700R1500	1	16000.00

MC512PA Terminal block markers

Blank card in polyamide

5.2 mm 0.205 in spacing

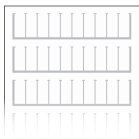

AMS 500

Features and Benefits

- MC512PA marker card in polyamide for standard industrial applications,
- Terminal blocks are directly independent after strip mounting,
- Improved marking visibility thanks to the increased marking surface +20% (12 mm 0.472 in)

Ordering Details

Description	Number of markers per unit	Color	Type	Catalog Number	Packing pieces	Weight 1 pc (g)
Blank card	100	White	MC512PA	1SNK149999R0000	20	10.00

Main Technical Data

Material	Flammability	Maximum printed digits				Dimensions	
		Horizontal	3	Vertical	8	mm	inches
Polyamide	V2	Horizontal	3	Vertical	8	4.8 x 12	0.189 x 0.472

Marking Systems

Description	Type	Catalog Number	Packing pieces	Weight 1 pc (g)
Marking table	AMS 500 KIT	XUSP02636	1	12600.00

MC512PA Terminal block markers

Pre-printed marker card for horizontal terminal block assembly

5.2 mm 0.205 in spacing

Features and Benefits

Save printing time with our large pre-printed cards offer with pre-printed numbers, letters or symbols.

Main Technical Data

Material	Flammability	Maximum printed digits			Dimensions	
		Horizontal	Vertical	mm	inches	
Polyamide	V2			4.8 x 12	0.189 x 0.472	

Ordering Details

Description	Number of markers per unit	Color	Type	Catalog Number	Pack ^(ing) pieces	Weight (1 pos) g
0->9 (x10)	100	White	MC512PA	1SNK140091R0000	10	10.00
1->10 (x10)	100	White	MC512PA	1SNK140011R0000	10	10.00
11->20 (x10)	100	White	MC512PA	1SNK140021R0000	10	10.00
21->30 (x10)	100	White	MC512PA	1SNK140031R0000	10	10.00
31->40 (x10)	100	White	MC512PA	1SNK140041R0000	10	10.00
41->50 (x10)	100	White	MC512PA	1SNK140051R0000	10	10.00
51->60 (x10)	100	White	MC512PA	1SNK140061R0000	10	10.00
61->70 (x10)	100	White	MC512PA	1SNK140071R0000	10	10.00
71->80 (x10)	100	White	MC512PA	1SNK140081R0000	10	10.00
81->90 (x10)	100	White	MC512PA	1SNK140083R0000	10	10.00
91->100 (x10)	100	White	MC512PA	1SNK140101R0000	10	10.00
101->110 (x10)	100	White	MC512PA	1SNK140111R0000	10	10.00
111->120 (x10)	100	White	MC512PA	1SNK140121R0000	10	10.00
121->130 (x10)	100	White	MC512PA	1SNK140131R0000	10	10.00
131->140 (x10)	100	White	MC512PA	1SNK140141R0000	10	10.00
141->150 (x10)	100	White	MC512PA	1SNK140151R0000	10	10.00
151->160 (x10)	100	White	MC512PA	1SNK140161R0000	10	10.00
161->170 (x10)	100	White	MC512PA	1SNK140171R0000	10	10.00
171->180 (x10)	100	White	MC512PA	1SNK140181R0000	10	10.00
181->190 (x10)	100	White	MC512PA	1SNK140191R0000	10	10.00
191->200 (x10)	100	White	MC512PA	1SNK140201R0000	10	10.00
1->100	100	White	MC512PA	1SNK145011R0000	10	10.00
101->200	100	White	MC512PA	1SNK145021R0000	10	10.00
201->300	100	White	MC512PA	1SNK145031R0000	10	10.00
301->400	100	White	MC512PA	1SNK145041R0000	10	10.00
401->500	100	White	MC512PA	1SNK145051R0000	10	10.00
501->600	100	White	MC512PA	1SNK145061R0000	10	10.00
601->700	100	White	MC512PA	1SNK145071R0000	10	10.00
701->800	100	White	MC512PA	1SNK145081R0000	10	10.00
801->900	100	White	MC512PA	1SNK145091R0000	10	10.00
A (x100)	100	White	MC512PA	1SNK146011R0000	10	10.00
B (x100)	100	White	MC512PA	1SNK146021R0000	10	10.00
C (x100)	100	White	MC512PA	1SNK146031R0000	10	10.00
D (x100)	100	White	MC512PA	1SNK146041R0000	10	10.00
E (x100)	100	White	MC512PA	1SNK146051R0000	10	10.00
F (x100)	100	White	MC512PA	1SNK146061R0000	10	10.00
G (x100)	100	White	MC512PA	1SNK146071R0000	10	10.00
H (x100)	100	White	MC512PA	1SNK146081R0000	10	10.00
I (x100)	100	White	MC512PA	1SNK146091R0000	10	10.00
J (x100)	100	White	MC512PA	1SNK146101R0000	10	10.00
K (x100)	100	White	MC512PA	1SNK146111R0000	10	10.00
L (x100)	100	White	MC512PA	1SNK146121R0000	10	10.00
M (x100)	100	White	MC512PA	1SNK146131R0000	10	10.00
N (x100)	100	White	MC512PA	1SNK146141R0000	10	10.00
O (x100)	100	White	MC512PA	1SNK146151R0000	10	10.00
P (x100)	100	White	MC512PA	1SNK146161R0000	10	10.00
Q (x100)	100	White	MC512PA	1SNK146171R0000	10	10.00
R (x100)	100	White	MC512PA	1SNK146181R0000	10	10.00
S (x100)	100	White	MC512PA	1SNK146191R0000	10	10.00
T (x100)	100	White	MC512PA	1SNK146201R0000	10	10.00
U (x100)	100	White	MC512PA	1SNK146211R0000	10	10.00
V (x100)	100	White	MC512PA	1SNK146221R0000	10	10.00
W (x100)	100	White	MC512PA	1SNK146231R0000	10	10.00



MC512PA Terminal block markers

Pre-printed marker card for horizontal terminal block assembly

5.2 mm 0.205 in spacing



Ordering Details

Description	Number of markers per unit	Color	Type	Catalog Number	Packing pieces	Weight 1 pc (g)
X (x100)	100	White	MC512PA	1SNK146241R0000	10	10.00
Y (x100)	100	White	MC512PA	1SNK146251R0000	10	10.00
Z (x100)	100	White	MC512PA	1SNK146261R0000	10	10.00
0 (x100)	100	White	MC512PA	1SNK147001R0000	10	10.00
1 (x100)	100	White	MC512PA	1SNK147011R0000	10	10.00
2 (x100)	100	White	MC512PA	1SNK147021R0000	10	10.00
3 (x100)	100	White	MC512PA	1SNK147031R0000	10	10.00
4 (x100)	100	White	MC512PA	1SNK147041R0000	10	10.00
5 (x100)	100	White	MC512PA	1SNK147051R0000	10	10.00
6 (x100)	100	White	MC512PA	1SNK147061R0000	10	10.00
7 (x100)	100	White	MC512PA	1SNK147071R0000	10	10.00
8 (x100)	100	White	MC512PA	1SNK147081R0000	10	10.00
9 (x100)	100	White	MC512PA	1SNK147091R0000	10	10.00
+ (x100)	100	White	MC512PA	1SNK148001R0000	10	10.00
- (x100)	100	White	MC512PA	1SNK148011R0000	10	10.00
~ (x100)	100	White	MC512PA	1SNK148021R0000	10	10.00
= (x100)	100	White	MC512PA	1SNK148031R0000	10	10.00
≠ (x100)	100	White	MC512PA	1SNK148041R0000	10	10.00
L1 (x100)	100	White	MC512PA	1SNK148051R0000	10	10.00
L2 (x100)	100	White	MC512PA	1SNK148061R0000	10	10.00
L3 (x100)	100	White	MC512PA	1SNK148071R0000	10	10.00
PE (x100)	100	White	MC512PA	1SNK148091R0000	10	10.00
U1 (x100)	100	White	MC512PA	1SNK148101R0000	10	10.00
U2 (x100)	100	White	MC512PA	1SNK148111R0000	10	10.00
U3 (x100)	100	White	MC512PA	1SNK148121R0000	10	10.00
V1 (x100)	100	White	MC512PA	1SNK148131R0000	10	10.00
V2 (x100)	100	White	MC512PA	1SNK148141R0000	10	10.00
V3 (x100)	100	White	MC512PA	1SNK148151R0000	10	10.00
W1 (x100)	100	White	MC512PA	1SNK148161R0000	10	10.00
W2 (x100)	100	White	MC512PA	1SNK148171R0000	10	10.00
W3 (x100)	100	White	MC512PA	1SNK148181R0000	10	10.00
L1-L2-L3-N-PE (x20)	100	White	MC512PA	1SNK149001R0000	10	10.00
U1-U2-U3-V1-V2-V3-W1-W2-W3 (x10) + U1 (x10)	100	White	MC512PA	1SNK149011R0000	10	10.00

10

MC512PA Terminal block markers

Pre-printed marker card for vertical terminal block assembly

5.2 mm 0.205 in spacing

Features and Benefits

Save printing time with our large pre-printed cards offer with pre-printed numbers, letters or symbols.

Main Technical Data

Material	Flammability	Maximum printed digits		Dimensions	
		Horizontal	Vertical	mm	inches
Polyamide	V2			4.8 x 12	0.189 x 0.472

Ordering Details

Description	Number of markers per unit	Color	Type	Catalog Number	Pack ⁽ⁿ⁾ pieces	Weight (1 pack) g
0->9 (x10)	100	White	MC512PA	1SNK140092R0000	10	10.00
1->10 (x10)	100	White	MC512PA	1SNK140012R0000	10	10.00
11->20 (x10)	100	White	MC512PA	1SNK140022R0000	10	10.00
21->30 (x10)	100	White	MC512PA	1SNK140032R0000	10	10.00
31->40 (x10)	100	White	MC512PA	1SNK140042R0000	10	10.00
41->50 (x10)	100	White	MC512PA	1SNK140052R0000	10	10.00
51->60 (x10)	100	White	MC512PA	1SNK140062R0000	10	10.00
61->70 (x10)	100	White	MC512PA	1SNK140072R0000	10	10.00
71->80 (x10)	100	White	MC512PA	1SNK140082R0000	10	10.00
81->90 (x10)	100	White	MC512PA	1SNK140084R0000	10	10.00
91->100 (x10)	100	White	MC512PA	1SNK140102R0000	10	10.00
101->110 (x10)	100	White	MC512PA	1SNK140112R0000	10	10.00
111->120 (x10)	100	White	MC512PA	1SNK140122R0000	10	10.00
121->130 (x10)	100	White	MC512PA	1SNK140132R0000	10	10.00
131->140 (x10)	100	White	MC512PA	1SNK140142R0000	10	10.00
141->150 (x10)	100	White	MC512PA	1SNK140152R0000	10	10.00
151->160 (x10)	100	White	MC512PA	1SNK140162R0000	10	10.00
161->170 (x10)	100	White	MC512PA	1SNK140172R0000	10	10.00
171->180 (x10)	100	White	MC512PA	1SNK140182R0000	10	10.00
181->190 (x10)	100	White	MC512PA	1SNK140192R0000	10	10.00
191->200 (x10)	100	White	MC512PA	1SNK140202R0000	10	10.00
1->100	100	White	MC512PA	1SNK145012R0000	10	10.00
101->200	100	White	MC512PA	1SNK145022R0000	10	10.00
201->300	100	White	MC512PA	1SNK145032R0000	10	10.00
301->400	100	White	MC512PA	1SNK145042R0000	10	10.00
401->500	100	White	MC512PA	1SNK145052R0000	10	10.00
501->600	100	White	MC512PA	1SNK145062R0000	10	10.00
601->700	100	White	MC512PA	1SNK145072R0000	10	10.00
701->800	100	White	MC512PA	1SNK145082R0000	10	10.00
801->900	100	White	MC512PA	1SNK145092R0000	10	10.00
901->1000	100	White	MC512PA	1SNK145102R0000	10	10.00
A (x100)	100	White	MC512PA	1SNK146012R0000	10	10.00
B (x100)	100	White	MC512PA	1SNK146022R0000	10	10.00
C (x100)	100	White	MC512PA	1SNK146032R0000	10	10.00
D (x100)	100	White	MC512PA	1SNK146042R0000	10	10.00
E (x100)	100	White	MC512PA	1SNK146052R0000	10	10.00
F (x100)	100	White	MC512PA	1SNK146062R0000	10	10.00
G (x100)	100	White	MC512PA	1SNK146072R0000	10	10.00
H (x100)	100	White	MC512PA	1SNK146082R0000	10	10.00
I (x100)	100	White	MC512PA	1SNK146092R0000	10	10.00
J (x100)	100	White	MC512PA	1SNK146102R0000	10	10.00
K (x100)	100	White	MC512PA	1SNK146112R0000	10	10.00
L (x100)	100	White	MC512PA	1SNK146122R0000	10	10.00
M (x100)	100	White	MC512PA	1SNK146132R0000	10	10.00
N (x100)	100	White	MC512PA	1SNK146142R0000	10	10.00
O (x100)	100	White	MC512PA	1SNK146152R0000	10	10.00
P (x100)	100	White	MC512PA	1SNK146162R0000	10	10.00
Q (x100)	100	White	MC512PA	1SNK146172R0000	10	10.00
R (x100)	100	White	MC512PA	1SNK146182R0000	10	10.00
S (x100)	100	White	MC512PA	1SNK146192R0000	10	10.00
T (x100)	100	White	MC512PA	1SNK146202R0000	10	10.00
U (x100)	100	White	MC512PA	1SNK146212R0000	10	10.00
V (x100)	100	White	MC512PA	1SNK146222R0000	10	10.00



MC512PA Terminal block markers

Pre-printed marker card for vertical terminal block assembly

5.2 mm 0.205 in spacing



Ordering Details

Description	Number of markers per unit	Color	Type	Catalog Number	Pack ^(n°) pieces	Weight (1 pcs) g
W (x100)	100	White	MC512PA	1SNK146232R0000	10	10.00
X (x100)	100	White	MC512PA	1SNK146242R0000	10	10.00
Y (x100)	100	White	MC512PA	1SNK146252R0000	10	10.00
Z (x100)	100	White	MC512PA	1SNK146262R0000	10	10.00
0 (x100)	100	White	MC512PA	1SNK147002R0000	10	10.00
1 (x100)	100	White	MC512PA	1SNK147012R0000	10	10.00
2 (x100)	100	White	MC512PA	1SNK147022R0000	10	10.00
3 (x100)	100	White	MC512PA	1SNK147032R0000	10	10.00
4 (x100)	100	White	MC512PA	1SNK147042R0000	10	10.00
5 (x100)	100	White	MC512PA	1SNK147052R0000	10	10.00
6 (x100)	100	White	MC512PA	1SNK147062R0000	10	10.00
7 (x100)	100	White	MC512PA	1SNK147072R0000	10	10.00
8 (x100)	100	White	MC512PA	1SNK147082R0000	10	10.00
9 (x100)	100	White	MC512PA	1SNK147092R0000	10	10.00
+ (x100)	100	White	MC512PA	1SNK148002R0000	10	10.00
- (x100)	100	White	MC512PA	1SNK148012R0000	10	10.00
~ (x100)	100	White	MC512PA	1SNK148022R0000	10	10.00
= (x100)	100	White	MC512PA	1SNK148032R0000	10	10.00
⊥ (x100)	100	White	MC512PA	1SNK148042R0000	10	10.00
L1 (x100)	100	White	MC512PA	1SNK148052R0000	10	10.00
L2 (x100)	100	White	MC512PA	1SNK148062R0000	10	10.00
L3 (x100)	100	White	MC512PA	1SNK148072R0000	10	10.00
PE (x100)	100	White	MC512PA	1SNK148092R0000	10	10.00
U1 (x100)	100	White	MC512PA	1SNK148102R0000	10	10.00
U2 (x100)	100	White	MC512PA	1SNK148112R0000	10	10.00
U3 (x100)	100	White	MC512PA	1SNK148122R0000	10	10.00
V1 (x100)	100	White	MC512PA	1SNK148132R0000	10	10.00
V2 (x100)	100	White	MC512PA	1SNK148142R0000	10	10.00
V3 (x100)	100	White	MC512PA	1SNK148152R0000	10	10.00
W1 (x100)	100	White	MC512PA	1SNK148162R0000	10	10.00
W2 (x100)	100	White	MC512PA	1SNK148172R0000	10	10.00
W3 (x100)	100	White	MC512PA	1SNK148182R0000	10	10.00
+24V (x100)	100	White	MC512PA	1SNK148192R0000	10	10.00
+48V (x100)	100	White	MC512PA	1SNK148202R0000	10	10.00
-24V (x100)	100	White	MC512PA	1SNK148212R0000	10	10.00
-48V (x100)	100	White	MC512PA	1SNK148222R0000	10	10.00
L1-L2-L3-N-PE (x20)	100	White	MC512PA	1SNK149002R0000	10	10.00
U1-U2-U3-V1-V2-V3-W1-W2-W3 (x10) + U1 (x10)	100	White	MC512PA	1SNK149012R0000	10	10.00

10

MC612 Terminal block markers

Blank card in polycarbonate

6 mm 0.236 in spacing

Features and Benefits

- MC612 marker card in polycarbonate for high marking quality and durability.
- Excellent marking durability in the most severe environments,
- Improved marking visibility thanks to the increased marking surface +20% (12 mm 0.472 in)

Ordering Details

Description	Number of markers per unit	Color	Type	Catalog Number	Pack ⁽ⁿ⁾ pieces	Weight (1 pce) g
Blank card	39	White	MC612	1SNK150000R0000	22	10.00
		Yellow	MC612-YL	1SNK150004R0000	22	10.00

Main Technical Data

Material	Flammability	Maximum printed digits				Dimensions	
		Horizontal	Vertical	mm	inches		
Polycarbonate	V0	3	8	5.6 x 12	0.220 x 0.472		

Marking Systems

Description	Type	Catalog Number	Pack ⁽ⁿ⁾ pieces	Weight (1 pce) g
Marking table	AMS 500 KIT	XUSP02636	1	12600.00
Thermal transfer printer	HTP500	1SNA235700R1500	1	16000.00



AMS 500



HTP500

10

MC612PA Terminal block markers

Blank card in polyamide

6 mm 0.236 in spacing

Features and Benefits

- MC612PA marker card in polyamide for standard industrial applications,
- Terminal blocks are directly independent after strip mounting,
- Improved marking visibility thanks to the increased marking surface +20% (12 mm 0.472 in)

Ordering Details

Description	Number of markers per unit	Color	Type	Catalog Number	Pack ⁽ⁿ⁾ pieces	Weight (1 pce) g
Blank card	100	White	MC612PA	1SNK159999R0000	20	11.00

Main Technical Data

Material	Flammability	Maximum printed digits				Dimensions	
		Horizontal	Vertical	mm	inches		
Polyamide	V2	3	8	5.6 x 12	0.220 x 0.472		

Marking Systems

Description	Type	Catalog Number	Pack ⁽ⁿ⁾ pieces	Weight (1 pce) g
Marking table	AMS 500 KIT	XUSP02636	1	12600.00

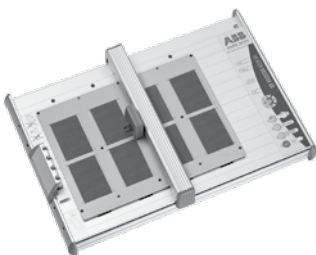
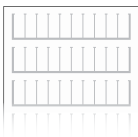

AMS 500

MC612PA Terminal block markers

Pre-printed marker card for horizontal terminal block assembly

6 mm 0.236 in spacing



Features and Benefits

Save printing time with our large pre-printed cards offer with pre-printed numbers, letters or symbols.

Main Technical Data

Material	Flammability	Maximum printed digits		Dimensions	
		Horizontal	Vertical	mm	inches
Polyamide	V2			5.6 x 12	0.220 x 0.472

Ordering Details

Description	Number of markers per unit	Color	Type	Catalog Number	Pack ⁽¹⁾ pieces	Weight (1 pcs) g
0->9 (x10)	100	White	MC612PA	1SNK150091R0000	10	11.00
1->10 (x10)	100	White	MC612PA	1SNK150011R0000	10	11.00
11->20 (x10)	100	White	MC612PA	1SNK150021R0000	10	11.00
21->30 (x10)	100	White	MC612PA	1SNK150031R0000	10	11.00
31->40 (x10)	100	White	MC612PA	1SNK150041R0000	10	11.00
41->50 (x10)	100	White	MC612PA	1SNK150051R0000	10	11.00
51->60 (x10)	100	White	MC612PA	1SNK150061R0000	10	11.00
61->70 (x10)	100	White	MC612PA	1SNK150071R0000	10	11.00
71->80 (x10)	100	White	MC612PA	1SNK150081R0000	10	11.00
81->90 (x10)	100	White	MC612PA	1SNK150083R0000	10	11.00
91->100 (x10)	100	White	MC612PA	1SNK150101R0000	10	11.00
101->110 (x10)	100	White	MC612PA	1SNK150111R0000	10	11.00
111->120 (x10)	100	White	MC612PA	1SNK150121R0000	10	11.00
121->130 (x10)	100	White	MC612PA	1SNK150131R0000	10	11.00
131->140 (x10)	100	White	MC612PA	1SNK150141R0000	10	11.00
141->150 (x10)	100	White	MC612PA	1SNK150151R0000	10	11.00
151->160 (x10)	100	White	MC612PA	1SNK150161R0000	10	11.00
161->170 (x10)	100	White	MC612PA	1SNK150171R0000	10	11.00
171->180 (x10)	100	White	MC612PA	1SNK150181R0000	10	11.00
181->190 (x10)	100	White	MC612PA	1SNK150191R0000	10	11.00
191->200 (x10)	100	White	MC612PA	1SNK150201R0000	10	11.00
1->100	100	White	MC612PA	1SNK155011R0000	10	11.00
101->200	100	White	MC612PA	1SNK155021R0000	10	11.00
201->300	100	White	MC612PA	1SNK155031R0000	10	11.00
301->400	100	White	MC612PA	1SNK155041R0000	10	11.00
401->500	100	White	MC612PA	1SNK155051R0000	10	11.00
501->600	100	White	MC612PA	1SNK155061R0000	10	11.00
601->700	100	White	MC612PA	1SNK155071R0000	10	11.00
701->800	100	White	MC612PA	1SNK155081R0000	10	11.00
801->900	100	White	MC612PA	1SNK155091R0000	10	11.00
A (x100)	100	White	MC612PA	1SNK156011R0000	10	11.00
B (x100)	100	White	MC612PA	1SNK156021R0000	10	11.00
C (x100)	100	White	MC612PA	1SNK156031R0000	10	11.00
D (x100)	100	White	MC612PA	1SNK156041R0000	10	11.00
E (x100)	100	White	MC612PA	1SNK156051R0000	10	11.00
F (x100)	100	White	MC612PA	1SNK156061R0000	10	11.00
G (x100)	100	White	MC612PA	1SNK156071R0000	10	11.00
H (x100)	100	White	MC612PA	1SNK156081R0000	10	11.00
I (x100)	100	White	MC612PA	1SNK156091R0000	10	11.00
J (x100)	100	White	MC612PA	1SNK156101R0000	10	11.00
K (x100)	100	White	MC612PA	1SNK156111R0000	10	11.00
L (x100)	100	White	MC612PA	1SNK156121R0000	10	11.00
M (x100)	100	White	MC612PA	1SNK156131R0000	10	11.00
N (x100)	100	White	MC612PA	1SNK156141R0000	10	11.00
O (x100)	100	White	MC612PA	1SNK156151R0000	10	11.00
P (x100)	100	White	MC612PA	1SNK156161R0000	10	11.00
Q (x100)	100	White	MC612PA	1SNK156171R0000	10	11.00
R (x100)	100	White	MC612PA	1SNK156181R0000	10	11.00
S (x100)	100	White	MC612PA	1SNK156191R0000	10	11.00
T (x100)	100	White	MC612PA	1SNK156201R0000	10	11.00
U (x100)	100	White	MC612PA	1SNK156211R0000	10	11.00
V (x100)	100	White	MC612PA	1SNK156221R0000	10	11.00
W (x100)	100	White	MC612PA	1SNK156231R0000	10	11.00

MC612PA Terminal block markers

Pre-printed marker card for horizontal terminal block assembly

6 mm 0.236 in spacing

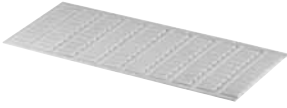

Ordering Details

Description	Number of markers per unit	Color	Type	Catalog Number	Pack ^(ng) pieces	Weight (1 pce) g
X (x100)	100	White	MC612PA	1SNK156241R0000	10	11.00
Y (x100)	100	White	MC612PA	1SNK156251R0000	10	11.00
Z (x100)	100	White	MC612PA	1SNK156261R0000	10	11.00
0 (x100)	100	White	MC612PA	1SNK157001R0000	10	11.00
1 (x100)	100	White	MC612PA	1SNK157011R0000	10	11.00
2 (x100)	100	White	MC612PA	1SNK157021R0000	10	11.00
3 (x100)	100	White	MC612PA	1SNK157031R0000	10	11.00
4 (x100)	100	White	MC612PA	1SNK157041R0000	10	11.00
5 (x100)	100	White	MC612PA	1SNK157051R0000	10	11.00
6 (x100)	100	White	MC612PA	1SNK157061R0000	10	11.00
7 (x100)	100	White	MC612PA	1SNK157071R0000	10	11.00
8 (x100)	100	White	MC612PA	1SNK157081R0000	10	11.00
9 (x100)	100	White	MC612PA	1SNK157091R0000	10	11.00
+ (x100)	100	White	MC612PA	1SNK158001R0000	10	11.00
- (x100)	100	White	MC612PA	1SNK158011R0000	10	11.00
~ (x100)	100	White	MC612PA	1SNK158021R0000	10	11.00
= (x100)	100	White	MC612PA	1SNK158031R0000	10	11.00
Ground (x100)	100	White	MC612PA	1SNK158041R0000	10	11.00
L1 (x100)	100	White	MC612PA	1SNK158051R0000	10	11.00
L2 (x100)	100	White	MC612PA	1SNK158061R0000	10	11.00
L3 (x100)	100	White	MC612PA	1SNK158071R0000	10	11.00
PE (x100)	100	White	MC612PA	1SNK158091R0000	10	11.00
U1 (x100)	100	White	MC612PA	1SNK158101R0000	10	11.00
U2 (x100)	100	White	MC612PA	1SNK158111R0000	10	11.00
U3 (x100)	100	White	MC612PA	1SNK158121R0000	10	11.00
V1 (x100)	100	White	MC612PA	1SNK158131R0000	10	11.00
V2 (x100)	100	White	MC612PA	1SNK158141R0000	10	11.00
V3 (x100)	100	White	MC612PA	1SNK158151R0000	10	11.00
W1 (x100)	100	White	MC612PA	1SNK158161R0000	10	11.00
W2 (x100)	100	White	MC612PA	1SNK158171R0000	10	11.00
W3 (x100)	100	White	MC612PA	1SNK158181R0000	10	11.00
L1-L2-L3-N-PE (x20)	100	White	MC612PA	1SNK159001R0000	10	11.00
U1-U2-U3-V1-V2-V3-W1-W2-W3 (x10) + U1 (x10)	100	White	MC612PA	1SNK159011R0000	10	11.00

MC612PA Terminal block markers

Pre-printed marker card for vertical terminal block assembly

6 mm 0.236 in spacing

Features and Benefits

Save printing time with our large pre-printed cards offer with pre-printed numbers, letters or symbols.

Main Technical Data

Material	Flammability	Maximum printed digits			Dimensions	
		Horizontal		Vertical	mm	inches
Polyamide	V2				5.6 x 12	0.220 x 0.472

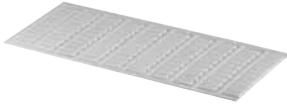

Ordering Details

Description	Number of markers per unit	Color	Type	Catalog Number	Pack ^(mg) pieces	Weight (1 pc) g
0->9 (x10)	100	White	MC612PA	1SNK150092R0000	10	11.00
1->10 (x10)	100	White	MC612PA	1SNK150012R0000	10	11.00
11->20 (x10)	100	White	MC612PA	1SNK150022R0000	10	11.00
21->30 (x10)	100	White	MC612PA	1SNK150032R0000	10	11.00
31->40 (x10)	100	White	MC612PA	1SNK150042R0000	10	11.00
41->50 (x10)	100	White	MC612PA	1SNK150052R0000	10	11.00
51->60 (x10)	100	White	MC612PA	1SNK150062R0000	10	11.00
61->70 (x10)	100	White	MC612PA	1SNK150072R0000	10	11.00
71->80 (x10)	100	White	MC612PA	1SNK150082R0000	10	11.00
81->90 (x10)	100	White	MC612PA	1SNK150084R0000	10	11.00
91->100 (x10)	100	White	MC612PA	1SNK150102R0000	10	11.00
101->110 (x10)	100	White	MC612PA	1SNK150112R0000	10	11.00
111->120 (x10)	100	White	MC612PA	1SNK150122R0000	10	11.00
121->130 (x10)	100	White	MC612PA	1SNK150132R0000	10	11.00
131->140 (x10)	100	White	MC612PA	1SNK150142R0000	10	11.00
141->150 (x10)	100	White	MC612PA	1SNK150152R0000	10	11.00
151->160 (x10)	100	White	MC612PA	1SNK150162R0000	10	11.00
161->170 (x10)	100	White	MC612PA	1SNK150172R0000	10	11.00
171->180 (x10)	100	White	MC612PA	1SNK150182R0000	10	11.00
181->190 (x10)	100	White	MC612PA	1SNK150192R0000	10	11.00
191->200 (x10)	100	White	MC612PA	1SNK150202R0000	10	11.00
1->100	100	White	MC612PA	1SNK155012R0000	10	11.00
101->200	100	White	MC612PA	1SNK155022R0000	10	11.00
201->300	100	White	MC612PA	1SNK155032R0000	10	11.00
301->400	100	White	MC612PA	1SNK155042R0000	10	11.00
401->500	100	White	MC612PA	1SNK155052R0000	10	11.00
501->600	100	White	MC612PA	1SNK155062R0000	10	11.00
601->700	100	White	MC612PA	1SNK155072R0000	10	11.00
701->800	100	White	MC612PA	1SNK155082R0000	10	11.00
801->900	100	White	MC612PA	1SNK155092R0000	10	11.00
901->1000	100	White	MC612PA	1SNK155102R0000	10	11.00
A (x100)	100	White	MC612PA	1SNK156012R0000	10	11.00
B (x100)	100	White	MC612PA	1SNK156022R0000	10	11.00
C (x100)	100	White	MC612PA	1SNK156032R0000	10	11.00
D (x100)	100	White	MC612PA	1SNK156042R0000	10	11.00
E (x100)	100	White	MC612PA	1SNK156052R0000	10	11.00
F (x100)	100	White	MC612PA	1SNK156062R0000	10	11.00
G (x100)	100	White	MC612PA	1SNK156072R0000	10	11.00
H (x100)	100	White	MC612PA	1SNK156082R0000	10	11.00
I (x100)	100	White	MC612PA	1SNK156092R0000	10	11.00
J (x100)	100	White	MC612PA	1SNK156102R0000	10	11.00
K (x100)	100	White	MC612PA	1SNK156112R0000	10	11.00
L (x100)	100	White	MC612PA	1SNK156122R0000	10	11.00
M (x100)	100	White	MC612PA	1SNK156132R0000	10	11.00
N (x100)	100	White	MC612PA	1SNK156142R0000	10	11.00
O (x100)	100	White	MC612PA	1SNK156152R0000	10	11.00
P (x100)	100	White	MC612PA	1SNK156162R0000	10	11.00
Q (x100)	100	White	MC612PA	1SNK156172R0000	10	11.00
R (x100)	100	White	MC612PA	1SNK156182R0000	10	11.00
S (x100)	100	White	MC612PA	1SNK156192R0000	10	11.00
T (x100)	100	White	MC612PA	1SNK156202R0000	10	11.00
U (x100)	100	White	MC612PA	1SNK156212R0000	10	11.00
V (x100)	100	White	MC612PA	1SNK156222R0000	10	11.00

MC612PA Terminal block markers

Pre-printed marker card for vertical terminal block assembly

6 mm 0.236 in spacing



Ordering Details

Description	Number of markers per unit	Color	Type	Catalog Number	Pack ⁽ⁿ⁾ pieces	Weight (1 pce) g
W (x100)	100	White	MC612PA	1SNK156232R0000	10	11.00
X (x100)	100	White	MC612PA	1SNK156242R0000	10	11.00
Y (x100)	100	White	MC612PA	1SNK156252R0000	10	11.00
Z (x100)	100	White	MC612PA	1SNK156262R0000	10	11.00
0 (x100)	100	White	MC612PA	1SNK157002R0000	10	11.00
1 (x100)	100	White	MC612PA	1SNK157012R0000	10	11.00
2 (x100)	100	White	MC612PA	1SNK157022R0000	10	11.00
3 (x100)	100	White	MC612PA	1SNK157032R0000	10	11.00
4 (x100)	100	White	MC612PA	1SNK157042R0000	10	11.00
5 (x100)	100	White	MC612PA	1SNK157052R0000	10	11.00
6 (x100)	100	White	MC612PA	1SNK157062R0000	10	11.00
7 (x100)	100	White	MC612PA	1SNK157072R0000	10	11.00
8 (x100)	100	White	MC612PA	1SNK157082R0000	10	11.00
9 (x100)	100	White	MC612PA	1SNK157092R0000	10	11.00
+ (x100)	100	White	MC612PA	1SNK158002R0000	10	11.00
- (x100)	100	White	MC612PA	1SNK158012R0000	10	11.00
~ (x100)	100	White	MC612PA	1SNK158022R0000	10	11.00
= (x100)	100	White	MC612PA	1SNK158032R0000	10	11.00
≠ (x100)	100	White	MC612PA	1SNK158042R0000	10	11.00
L1 (x100)	100	White	MC612PA	1SNK158052R0000	10	11.00
L2 (x100)	100	White	MC612PA	1SNK158062R0000	10	11.00
L3 (x100)	100	White	MC612PA	1SNK158072R0000	10	11.00
PE (x100)	100	White	MC612PA	1SNK158092R0000	10	11.00
U1 (x100)	100	White	MC612PA	1SNK158102R0000	10	11.00
U2 (x100)	100	White	MC612PA	1SNK158112R0000	10	11.00
U3 (x100)	100	White	MC612PA	1SNK158122R0000	10	11.00
V1 (x100)	100	White	MC612PA	1SNK158132R0000	10	11.00
V2 (x100)	100	White	MC612PA	1SNK158142R0000	10	11.00
V3 (x100)	100	White	MC612PA	1SNK158152R0000	10	11.00
W1 (x100)	100	White	MC612PA	1SNK158162R0000	10	11.00
W2 (x100)	100	White	MC612PA	1SNK158172R0000	10	11.00
W3 (x100)	100	White	MC612PA	1SNK158182R0000	10	11.00
+24V (x100)	100	White	MC612PA	1SNK158192R0000	10	11.00
+48V (x100)	100	White	MC612PA	1SNK158202R0000	10	11.00
-24V (x100)	100	White	MC612PA	1SNK158212R0000	10	11.00
-48V (x100)	100	White	MC612PA	1SNK158222R0000	10	11.00
L1-L2-L3-N-PE (x20)	100	White	MC612PA	1SNK159002R0000	10	11.00
U1-U2-U3-V1-V2-V3-W1-W2-W3 (x10) + U1 (x10)	100	White	MC612PA	1SNK159012R0000	10	11.00

MC812 Terminal block markers

Blank card in polycarbonate

8 mm 0.315 in spacing



AMS 500



HTP500

Features and Benefits

- MC812 marker card in polycarbonate for high marking quality and durability.
- Excellent marking durability in the most severe environments.
- Improved marking visibility thanks to the increased marking surface +20% (12 mm 0.472 in)

Ordering Details

Description	Number of markers per unit	Color	Type	Catalog Number	Pack ^(nsl) pieces	Weight (1 pce) g
Blank card	30	White	MC812	1SNK160000R0000	22	10.00
		Yellow	MC812-YL	1SNK160004R0000	22	10.00

Main Technical Data

Material	Flammability	Maximum printed digits				Dimensions	
		Horizontal	3	Vertical	8	mm	inches
Polycarbonate	V0	Horizontal	3	Vertical	8	7.6 x 12	0.299 x 0.472

Marking Systems

Description	Type	Catalog Number	Pack ^(nsl) pieces	Weight (1 pce) g
Marking table	AMS 500 KIT	XUSP02636	1	12600.00
Thermal transfer printer	HTP500	1SNA235700R1500	1	16000.00

MC812PA Terminal block markers

Blank card in polyamide

8 mm 0.315 in spacing

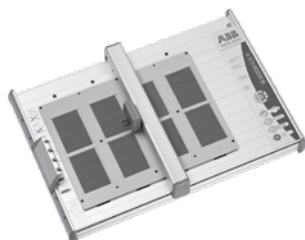
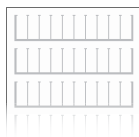

AMS 500

Features and Benefits

- MC812PA marker card in polyamide for standard industrial applications.
- Terminal blocks are directly independent after strip mounting.
- Improved marking visibility thanks to the increased marking surface +20% (12 mm 0.472 in)

Ordering Details

Description	Number of markers per unit	Color	Type	Catalog Number	Pack ^(nsl) pieces	Weight (1 pce) g
Blank card	100	White	MC812PA	1SNK169999R0000	20	14.00

Main Technical Data

Material	Flammability	Maximum printed digits				Dimensions	
		Horizontal	3	Vertical	8	mm	inches
Polyamide	V2	Horizontal	3	Vertical	8	7.6 x 12	0.299 x 0.472

Marking Systems

Description	Type	Catalog Number	Pack ^(nsl) pieces	Weight (1 pce) g
Marking table	AMS 500 KIT	XUSP02636	1	12600.00

MC812PA Terminal block markers

Pre-printed marker card for horizontal terminal block assembly

8 mm 0.315 in spacing



Features and Benefits

Save printing time with our large pre-printed cards offer with pre-printed numbers, letters or symbols.

Main Technical Data

Material	Flammability	Maximum printed digits			Dimensions	
		Horizontal		Vertical	mm	inches
Polyamide	V2				7.6 x 12	0.299 x 0.472

Ordering Details



Description	Number of markers per unit	Color	Type	Catalog Number	Pack ^(ng) pieces	Weight (1 pce) g
0->9 (x10)	100	White	MC812PA	1SNK160091R0000	10	14.00
1->10 (x10)	100	White	MC812PA	1SNK160011R0000	10	14.00
11->20 (x10)	100	White	MC812PA	1SNK160021R0000	10	14.00
21->30 (x10)	100	White	MC812PA	1SNK160031R0000	10	14.00
31->40 (x10)	100	White	MC812PA	1SNK160041R0000	10	14.00
41->50 (x10)	100	White	MC812PA	1SNK160051R0000	10	14.00
51->60 (x10)	100	White	MC812PA	1SNK160061R0000	10	14.00
61->70 (x10)	100	White	MC812PA	1SNK160071R0000	10	14.00
71->80 (x10)	100	White	MC812PA	1SNK160081R0000	10	14.00
81->90 (x10)	100	White	MC812PA	1SNK160083R0000	10	14.00
91->100 (x10)	100	White	MC812PA	1SNK160101R0000	10	14.00
101->110 (x10)	100	White	MC812PA	1SNK160111R0000	10	14.00
111->120 (x10)	100	White	MC812PA	1SNK160121R0000	10	14.00
121->130 (x10)	100	White	MC812PA	1SNK160131R0000	10	14.00
131->140 (x10)	100	White	MC812PA	1SNK160141R0000	10	14.00
141->150 (x10)	100	White	MC812PA	1SNK160151R0000	10	14.00
151->160 (x10)	100	White	MC812PA	1SNK160161R0000	10	14.00
161->170 (x10)	100	White	MC812PA	1SNK160171R0000	10	14.00
171->180 (x10)	100	White	MC812PA	1SNK160181R0000	10	14.00
181->190 (x10)	100	White	MC812PA	1SNK160191R0000	10	14.00
191->200 (x10)	100	White	MC812PA	1SNK160201R0000	10	14.00
1->100	100	White	MC812PA	1SNK165011R0000	10	14.00
101->200	100	White	MC812PA	1SNK165021R0000	10	14.00
201->300	100	White	MC812PA	1SNK165031R0000	10	14.00
301->400	100	White	MC812PA	1SNK165041R0000	10	14.00
401->500	100	White	MC812PA	1SNK165051R0000	10	14.00
501->600	100	White	MC812PA	1SNK165061R0000	10	14.00
601->700	100	White	MC812PA	1SNK165071R0000	10	14.00
701->800	100	White	MC812PA	1SNK165081R0000	10	14.00
801->900	100	White	MC812PA	1SNK165091R0000	10	14.00
A (x100)	100	White	MC812PA	1SNK166011R0000	10	14.00
B (x100)	100	White	MC812PA	1SNK166021R0000	10	14.00
C (x100)	100	White	MC812PA	1SNK166031R0000	10	14.00
D (x100)	100	White	MC812PA	1SNK166041R0000	10	14.00
E (x100)	100	White	MC812PA	1SNK166051R0000	10	14.00
F (x100)	100	White	MC812PA	1SNK166061R0000	10	14.00
G (x100)	100	White	MC812PA	1SNK166071R0000	10	14.00
H (x100)	100	White	MC812PA	1SNK166081R0000	10	14.00
I (x100)	100	White	MC812PA	1SNK166091R0000	10	14.00
J (x100)	100	White	MC812PA	1SNK166101R0000	10	14.00
K (x100)	100	White	MC812PA	1SNK166111R0000	10	14.00
L (x100)	100	White	MC812PA	1SNK166121R0000	10	14.00
M (x100)	100	White	MC812PA	1SNK166131R0000	10	14.00
N (x100)	100	White	MC812PA	1SNK166141R0000	10	14.00
O (x100)	100	White	MC812PA	1SNK166151R0000	10	14.00
P (x100)	100	White	MC812PA	1SNK166161R0000	10	14.00
Q (x100)	100	White	MC812PA	1SNK166171R0000	10	14.00
R (x100)	100	White	MC812PA	1SNK166181R0000	10	14.00
S (x100)	100	White	MC812PA	1SNK166191R0000	10	14.00
T (x100)	100	White	MC812PA	1SNK166201R0000	10	14.00
U (x100)	100	White	MC812PA	1SNK166211R0000	10	14.00
V (x100)	100	White	MC812PA	1SNK166221R0000	10	14.00
W (x100)	100	White	MC812PA	1SNK166231R0000	10	14.00

MC812PA Terminal block markers

Pre-printed marker card for horizontal terminal block assembly

8 mm 0.315 in spacing



Ordering Details

Description	Number of markers per unit	Color	Type	Catalog Number	Pack ^(ng) pieces	Weight (1 pce) g
X (x100)	100	White	MC812PA	1SNK166241R0000	10	14.00
Y (x100)	100	White	MC812PA	1SNK166251R0000	10	14.00
Z (x100)	100	White	MC812PA	1SNK166261R0000	10	14.00
0 (x100)	100	White	MC812PA	1SNK167001R0000	10	14.00
1 (x100)	100	White	MC812PA	1SNK167011R0000	10	14.00
2 (x100)	100	White	MC812PA	1SNK167021R0000	10	14.00
3 (x100)	100	White	MC812PA	1SNK167031R0000	10	14.00
4 (x100)	100	White	MC812PA	1SNK167041R0000	10	14.00
5 (x100)	100	White	MC812PA	1SNK167051R0000	10	14.00
6 (x100)	100	White	MC812PA	1SNK167061R0000	10	14.00
7 (x100)	100	White	MC812PA	1SNK167071R0000	10	14.00
8 (x100)	100	White	MC812PA	1SNK167081R0000	10	14.00
9 (x100)	100	White	MC812PA	1SNK167091R0000	10	14.00
+ (x100)	100	White	MC812PA	1SNK168001R0000	10	14.00
- (x100)	100	White	MC812PA	1SNK168011R0000	10	14.00
~ (x100)	100	White	MC812PA	1SNK168021R0000	10	14.00
= (x100)	100	White	MC812PA	1SNK168031R0000	10	14.00
≠ (x100)	100	White	MC812PA	1SNK168041R0000	10	14.00
L1 (x100)	100	White	MC812PA	1SNK168051R0000	10	14.00
L2 (x100)	100	White	MC812PA	1SNK168061R0000	10	14.00
L3 (x100)	100	White	MC812PA	1SNK168071R0000	10	14.00
PE (x100)	100	White	MC812PA	1SNK168091R0000	10	14.00
U1 (x100)	100	White	MC812PA	1SNK168101R0000	10	14.00
U2 (x100)	100	White	MC812PA	1SNK168111R0000	10	14.00
U3 (x100)	100	White	MC812PA	1SNK168121R0000	10	14.00
V1 (x100)	100	White	MC812PA	1SNK168131R0000	10	14.00
V2 (x100)	100	White	MC812PA	1SNK168141R0000	10	14.00
V3 (x100)	100	White	MC812PA	1SNK168151R0000	10	14.00
W1 (x100)	100	White	MC812PA	1SNK168161R0000	10	14.00
W2 (x100)	100	White	MC812PA	1SNK168171R0000	10	14.00
W3 (x100)	100	White	MC812PA	1SNK168181R0000	10	14.00
L1-L2-L3-N-PE (x20)	100	White	MC812PA	1SNK169001R0000	10	14.00
U1-U2-U3-V1-V2-V3-W1-W2-W3 (x10) + U1 (x10)	100	White	MC812PA	1SNK169011R0000	10	14.00

MC812PA Terminal block markers

Pre-printed marker card for vertical terminal block assembly

8 mm 0.315 in spacing

Features and Benefits

Save printing time with our large pre-printed cards offer with pre-printed numbers, letters or symbols.

Main Technical Data

Material	Flammability	Maximum printed digits		Dimensions	
		Horizontal	Vertical	mm	inches
Polyamide	V2			7.6 x 12	0.299 x 0.472

Ordering Details

Description	Number of markers per unit	Color	Type	Catalog Number	Pack ^(ng) pieces	Weight (1 pcs) g
0->9 (x10)	100	White	MC812PA	1SNK160092R0000	10	14.00
1->10 (x10)	100	White	MC812PA	1SNK160012R0000	10	14.00
11->20 (x10)	100	White	MC812PA	1SNK160022R0000	10	14.00
21->30 (x10)	100	White	MC812PA	1SNK160032R0000	10	14.00
31->40 (x10)	100	White	MC812PA	1SNK160042R0000	10	14.00
41->50 (x10)	100	White	MC812PA	1SNK160052R0000	10	14.00
51->60 (x10)	100	White	MC812PA	1SNK160062R0000	10	14.00
61->70 (x10)	100	White	MC812PA	1SNK160072R0000	10	14.00
71->80 (x10)	100	White	MC812PA	1SNK160082R0000	10	14.00
81->90 (x10)	100	White	MC812PA	1SNK160084R0000	10	14.00
91->100 (x10)	100	White	MC812PA	1SNK160102R0000	10	14.00
101->110 (x10)	100	White	MC812PA	1SNK160112R0000	10	14.00
111->120 (x10)	100	White	MC812PA	1SNK160122R0000	10	14.00
121->130 (x10)	100	White	MC812PA	1SNK160132R0000	10	14.00
131->140 (x10)	100	White	MC812PA	1SNK160142R0000	10	14.00
141->150 (x10)	100	White	MC812PA	1SNK160152R0000	10	14.00
151->160 (x10)	100	White	MC812PA	1SNK160162R0000	10	14.00
161->170 (x10)	100	White	MC812PA	1SNK160172R0000	10	14.00
171->180 (x10)	100	White	MC812PA	1SNK160182R0000	10	14.00
181->190 (x10)	100	White	MC812PA	1SNK160192R0000	10	14.00
191->200 (x10)	100	White	MC812PA	1SNK160202R0000	10	14.00
1->100	100	White	MC812PA	1SNK165012R0000	10	14.00
101->200	100	White	MC812PA	1SNK165022R0000	10	14.00
201->300	100	White	MC812PA	1SNK165032R0000	10	14.00
301->400	100	White	MC812PA	1SNK165042R0000	10	14.00
401->500	100	White	MC812PA	1SNK165052R0000	10	14.00
501->600	100	White	MC812PA	1SNK165062R0000	10	14.00
601->700	100	White	MC812PA	1SNK165072R0000	10	14.00
701->800	100	White	MC812PA	1SNK165082R0000	10	14.00
801->900	100	White	MC812PA	1SNK165092R0000	10	14.00
901->1000	100	White	MC812PA	1SNK165102R0000	10	14.00
A (x100)	100	White	MC812PA	1SNK166012R0000	10	14.00
B (x100)	100	White	MC812PA	1SNK166022R0000	10	14.00
C (x100)	100	White	MC812PA	1SNK166032R0000	10	14.00
D (x100)	100	White	MC812PA	1SNK166042R0000	10	14.00
E (x100)	100	White	MC812PA	1SNK166052R0000	10	14.00
F (x100)	100	White	MC812PA	1SNK166062R0000	10	14.00
G (x100)	100	White	MC812PA	1SNK166072R0000	10	14.00
H (x100)	100	White	MC812PA	1SNK166082R0000	10	14.00
I (x100)	100	White	MC812PA	1SNK166092R0000	10	14.00
J (x100)	100	White	MC812PA	1SNK166102R0000	10	14.00
K (x100)	100	White	MC812PA	1SNK166112R0000	10	14.00
L (x100)	100	White	MC812PA	1SNK166122R0000	10	14.00
M (x100)	100	White	MC812PA	1SNK166132R0000	10	14.00
N (x100)	100	White	MC812PA	1SNK166142R0000	10	14.00
O (x100)	100	White	MC812PA	1SNK166152R0000	10	14.00
P (x100)	100	White	MC812PA	1SNK166162R0000	10	14.00
Q (x100)	100	White	MC812PA	1SNK166172R0000	10	14.00
R (x100)	100	White	MC812PA	1SNK166182R0000	10	14.00
S (x100)	100	White	MC812PA	1SNK166192R0000	10	14.00
T (x100)	100	White	MC812PA	1SNK166202R0000	10	14.00
U (x100)	100	White	MC812PA	1SNK166212R0000	10	14.00
V (x100)	100	White	MC812PA	1SNK166222R0000	10	14.00



MC812PA Terminal block markers

Pre-printed marker card for vertical terminal block assembly

8 mm 0.315 in spacing



Ordering Details

Description	Number of markers per unit	Color	Type	Catalog Number	Pack ^(mg) pieces	Weight (1 pce) g
W (x100)	100	White	MC812PA	1SNK166232R0000	10	14.00
X (x100)	100	White	MC812PA	1SNK166242R0000	10	14.00
Y (x100)	100	White	MC812PA	1SNK166252R0000	10	14.00
Z (x100)	100	White	MC812PA	1SNK166262R0000	10	14.00
0 (x100)	100	White	MC812PA	1SNK167002R0000	10	14.00
1 (x100)	100	White	MC812PA	1SNK167012R0000	10	14.00
2 (x100)	100	White	MC812PA	1SNK167022R0000	10	14.00
3 (x100)	100	White	MC812PA	1SNK167032R0000	10	14.00
4 (x100)	100	White	MC812PA	1SNK167042R0000	10	14.00
5 (x100)	100	White	MC812PA	1SNK167052R0000	10	14.00
6 (x100)	100	White	MC812PA	1SNK167062R0000	10	14.00
7 (x100)	100	White	MC812PA	1SNK167072R0000	10	14.00
8 (x100)	100	White	MC812PA	1SNK167082R0000	10	14.00
9 (x100)	100	White	MC812PA	1SNK167092R0000	10	14.00
+ (x100)	100	White	MC812PA	1SNK168002R0000	10	14.00
- (x100)	100	White	MC812PA	1SNK168012R0000	10	14.00
~ (x100)	100	White	MC812PA	1SNK168022R0000	10	14.00
= (x100)	100	White	MC812PA	1SNK168032R0000	10	14.00
≡ (x100)	100	White	MC812PA	1SNK168042R0000	10	14.00
L1 (x100)	100	White	MC812PA	1SNK168052R0000	10	14.00
L2 (x100)	100	White	MC812PA	1SNK168062R0000	10	14.00
L3 (x100)	100	White	MC812PA	1SNK168072R0000	10	14.00
PE (x100)	100	White	MC812PA	1SNK168092R0000	10	14.00
U1 (x100)	100	White	MC812PA	1SNK168102R0000	10	14.00
U2 (x100)	100	White	MC812PA	1SNK168112R0000	10	14.00
U3 (x100)	100	White	MC812PA	1SNK168122R0000	10	14.00
V1 (x100)	100	White	MC812PA	1SNK168132R0000	10	14.00
V2 (x100)	100	White	MC812PA	1SNK168142R0000	10	14.00
V3 (x100)	100	White	MC812PA	1SNK168152R0000	10	14.00
W1 (x100)	100	White	MC812PA	1SNK168162R0000	10	14.00
W2 (x100)	100	White	MC812PA	1SNK168172R0000	10	14.00
W3 (x100)	100	White	MC812PA	1SNK168182R0000	10	14.00
+24V (x100)	100	White	MC812PA	1SNK168192R0000	10	14.00
+48V (x100)	100	White	MC812PA	1SNK168202R0000	10	14.00
-24V (x100)	100	White	MC812PA	1SNK168212R0000	10	14.00
-48V (x100)	100	White	MC812PA	1SNK168222R0000	10	14.00
L1-L2-L3-N-PE (x20)	100	White	MC812PA	1SNK169002R0000	10	14.00
U1-U2-U3-V1-V2-V3-W1-W2-W3 (x10) + U1 (x10)	100	White	MC812PA	1SNK169012R0000	10	14.00

10

SAT Terminal block markers

Self adhesive strip



Features and Benefits

- Quickly mark your terminal blocks with the pre-cut Self Adhesive strip SAT. Delivered 10 markers per strip.
- Easily print your self adhesive sheet in A5 format on any desktop printer: laser and inkjet,
- The SAT unique adhesive allows the terminal block label to be repositioned during the first few minutes.
- The excellent properties of SAT (adhesive and ink withstand) tested in our laboratories, offer an optimized resistance to severe environments (humidity, heat, oil, water, etc.).

Main Technical Data

Material	Flammability
Polyethylene	V0

Ordering Details

SAT5 Self adhesive strip for 5.2 mm 0.205 in spacing terminal blocks

Label dimensions		No markers per unit	Maximum printed digits		Color	Type	Catalog Number	Pack ⁽ⁿ⁾ pieces	Weight (1 pce) g
mm	inches		Horizontal	Vertical					
9 x 5.2	0.354 x 0.205	240	3	6	White	SAT5	1SNK900614R0000	5	6.00

Ordering Details

SAT6 Self adhesive strip for 6 mm 0.236 in spacing terminal blocks

Label dimensions		No markers per unit	Maximum printed digits		Color	Type	Catalog Number	Pack ⁽ⁿ⁾ pieces	Weight (1 pce) g
mm	inches		Horizontal	Vertical					
9 x 5.8	0.354 x 0.228	240	3	6	White	SAT6	1SNK900615R0000	5	6.00

Ordering Details

SAT8 Self adhesive strip for 8 mm 0.315 in spacing terminal blocks

Label dimensions		No markers per unit	Maximum printed digits		Color	Type	Catalog Number	Pack ⁽ⁿ⁾ pieces	Weight (1 pce) g
mm	inches		Horizontal	Vertical					
9 x 7.8	0.354 x 0.307	160	4	6	White	SAT8	1SNK900616R0000	5	6.00

Accessories

PROCAP Protecting cap

Description	No of caps per unit	Color	Type	Catalog Number	Pack ⁽ⁿ⁾ pieces	Weight (1 pce) g
for Self Adhesive sTrip SAT5	10	Transparent	PROCAP5	1SNK900609R0000	20	0.70
for Self Adhesive sTrip SAT6	10	Transparent	PROCAP6	1SNK900612R0000	20	0.79
for Self Adhesive sTrip SAT8	10	Transparent	PROCAP8	1SNK900613R0000	20	1.00



UMH Universal wire markers holder

Markers and marking systems

5.2 mm 0.205 in spacing



Mounting Instructions



Install the UMH on the terminal blocks (strip mounting) and slide on the wire markers.

Features and Benefits

- Compatible with most of the wire markers available on the market (wire markers not supplied with UMH);
- Quickly installs on any SNK terminal blocks: Mounts in strips of 10 for 5.2 mm (0.205 in) spacing, individual mounting for other terminal block spacings.

Ordering Details

Description	Color	Type	Catalog Number	Pack ^(ng) pieces	Weight (1 pce) g
5.2 mm 0.205 in spacing	Grey	UMH	1SNK900611R0000	10	0.20

Main Technical Data

Material Specifications	Insulating material	Polyamide	
	Flammability	V0	
	NF F 16 101	I2F2	
Ambient temperature min/max	Service IEC 60068-2-1	-55 +110 °C	-67 +230 F
	Storage	-55 +110 °C	-67 +230 F
	Installing	-5 +40 °C	-23 +104 F

MCLH Label

Markers and marking systems



Features and Benefits

Identify your terminal blocks assembly with the self adhesive label adapted to the LH label holders.

Ordering Details

Description	Color	Type	Catalog Number	Pack ^(ng) pieces	Weight (1 pce) g
for LH label holder	White	MCLH	1SNK900630R0000	25	10.00
	Yellow	MCLH-YL	1SNK900633R0000	25	10.00
for LH-R1 label holder	White	MCLH-R1	1SNK900631R0000	25	10.00
	Yellow	MCLH-R1-YL	1SNK900634R0000	25	10.00

Main Technical Data

Material Specifications	Insulating material	PVC + Adhesive acrylic	
	Flammability	V0	
	NF F 16 101		
Ambient temperature min/max	Service IEC 60068-2-1	-55 +110 °C	-67 +230 F
	Storage	-55 +110 °C	-67 +230 F
	Installing	-5 +40 °C	-23 +104 F

Marking Systems

Description	Type	Catalog Number	Pack ^(ng) pieces	Weight (1 pce) g
Marking table	AMS 500 KIT	XUSP02636	1	12600.00

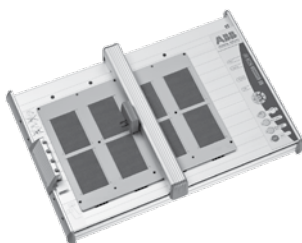

AMS 500

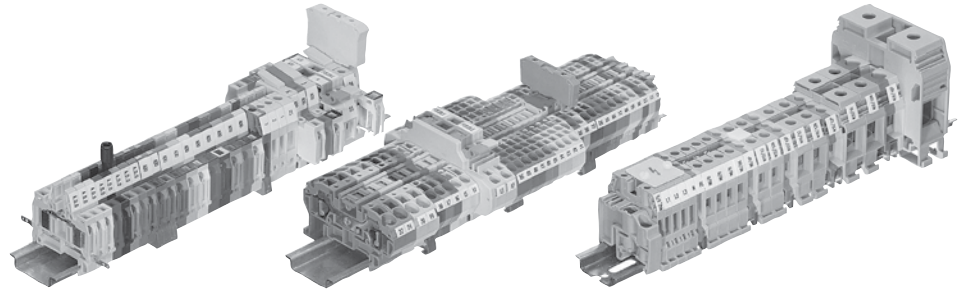

Screw technology

- The classic connection
- Multiple wires per connection
- Available in several colors
- 24 AWG to 600 MCM

Spring technology

- The top entry connection
- One wire per connection
- 26-2 AWG

IDC technology

- The fastest connection known
- Vibration and corrosion proof
- Multiple wires, 24-12 AWG

Multiple wire termination UL approved, basic blocks

Terminal block type	Terminal block thickness	1 wire AWG	2 wire AWG	3 wire AWG
MA 2.5/5	5mm	22 to 12	18	20
M 4/6	6mm	22 to 10	22 to 14	22 or 20
M 6/8	8mm	22 to 8	22 to 14	22 to 16
M 10/10	10mm	20 to 6	20 to 12	20 or 18
M 16/12	12mm	6 to 4	14 to 8	14
M 35/16	16mm	10 to 1/0	10 to 4	-
M 70/22	22mm	4 to 2/0	4 or 2	4

UL File Number E60645

10

Worldwide approvals

USA	DEMKO / Denmark	Great Britain	NEMKO, DNV / Norway
Canada	Electricity Inspectorate Finland	MEEI / Hungary	SEMKO / Sweden
Austria	Germany	Netherlands	Switzerland
Commonwealth of Independent States (Formerly USSR)	Germ. Lloyd / Germany		

Feed through and ground terminal blocks

Screw clamp, DIN 1-3

MA 2,5/5 - 2.5 mm² blocks - 5 mm .200" spacing

Characteristics

		IEC		UL	CSA
		NFC	DIN		
Wire size	Solid	0.2 - 4 mm ²		22-12 AWG	22-12 AWG
mm ² / AWG	Stranded	0.22 - 2.5 mm ²			
Voltage	V	800		600	600
Current	A	24		30	25
Short circuit current (MA 2,5/5.P)	A / s	300A/1s			
Rated wire size	mm ² / AWG	2.5 mm ²		12 AWG	12 AWG
Wire stripping length	mm / inches			10 mm / .39"	
Recommended torque	Nm / lb.in			0.4-0.6 Nm / 3.5-5.3 lb.in	

Selection

Description	Type	Packaging	Catalog number
Standard block grey	MA 2,5/5	50	011548603
Standard block white	MA 2,5/5	50	010505221
Standard block blue	MA 2,5/5.N	50	012548605
Standard block yellow	MA 2,5/5	50	010548612
Standard block orange	MA 2,5/5	50	010507520
Standard block black	MA 2,5/5	50	010507722
Standard block red	MA 2,5/5	50	040018427
Standard block beige	MA 2,5/5	50	019548604

Accessories

Description	Type	Packaging	Catalog number
End stop	BAM2 9.9 mm	50	020635116
End section	grey FEM6 2.8 mm	20	011836816
	blue FEM6 2.8 mm	20	012836810
	orange FEM6 2.8 mm	20	010312616
	yellow FEM6 2.8 mm	20	010306221
	green FEM6 2.8 mm	20	010312515
Separator end section	grey SCF6 3 mm	20	011870703
Assembled jumper bar (with IP20 protection)	2 poles BJMI5 24 A	10	017627816
	3 poles BJMI5 24 A	10	017627917
	4 poles BJMI5 24 A	10	017628005
	5 poles BJMI5 24 A	10	017628122
	10 poles BJMI5 24 A	10	017628223
Shield connector	CBM5 0.5 mm	20	017874514
	CBM8 0.8 mm	20	017874615

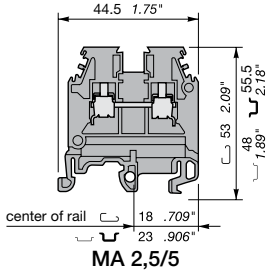

10

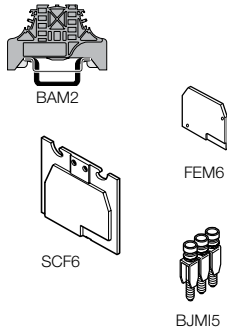

MA 2,5/5.P - 2.5 mm² ground block with rail contact - 5 mm .200" spacing

Characteristics

		IEC		UL	CSA
		NFC	DIN		
Wire size	Solid	0.2 - 4 mm ²		22-12 AWG	22-12 AWG
mm ² / AWG	Stranded	0.22 - 2.5 mm ²			
Short circuit current	A / s	300A/1s			
Rated wire size	mm ² / AWG	2.5 mm ²		12 AWG	12 AWG
Wire stripping length	mm / inches			10 mm / .39"	
Recommended torque	Nm / lb.in			0.4-0.6 Nm / 3.5-5.3 lb.in	

Selection

Description	Type	Packaging	Catalog number
Ground block green/yellow Mounting on DIN 3 rail without screw	MA 2,5/5.P	50	016548827
Separator end section	D 2,5/5.P	50	016590905

Accessories

Description	Type	Packaging	Catalog number
End section	yellow FEM6 2.8 mm	20	010306221
Separator end section	grey SCF6 3 mm	20	011870703

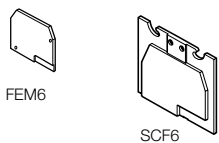
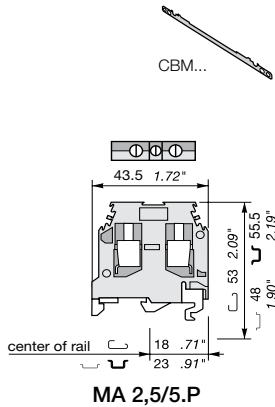

Feed through and ground terminal blocks

Screw clamp, U U DIN 1-3

M 4/6 - 4 mm² blocks - 6 mm .238" spacing

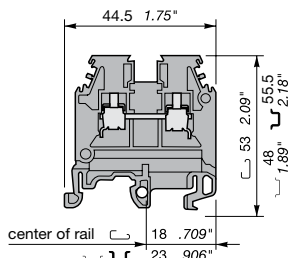

M 4/6

Characteristics		IEC		UL	CSA
		NFC	DIN		
Wire size	Solid	0.2 - 4 mm ²		22-10 AWG	22-10 AWG
mm ² / AWG	Stranded	0.22 - 4 mm ²			
Voltage	V	800		600	600
Current	A	32		30	25
Short circuit current (M 4/6.PI)	A / s	480A/1s			
Rated wire size	mm ² / AWG	4 mm ²		10 AWG	10 AWG
Wire stripping length	mm / inches	9.5 mm / .37"			
Recommended torque	Nm / lb.in	0.5-0.8 Nm / 4.4-7.1 lb.in			

Selection

Description	Type	Packaging	Catalog number
Standard block grey	M 4/6	50	011511607
Standard block blue	M 4/6.N	50	012511601
Standard block yellow	M 4/6	50	010511616
Standard block orange	M 4/6	50	010500220
Standard block red	M 4/6	50	010503215
Standard block black	M 4/6	50	010503114
Standard block beige	M 4/6	50	019511600
Standard block brown	M 4/6	50	010520914
Standard block white	M 4/6	50	010505120
Standard block green	M 4/6	50	010500127
Standard block violet	M 4/6	50	020640405

Accessories

Description	Type	Packaging	Catalog number
End stop	BAM2 9.9 mm	50	020635116
End section	grey FEM6 2.8 mm	20	011836816
	blue FEM6 2.8 mm	20	012836810
	orange FEM6 2.8 mm	20	010312616
	yellow FEM6 2.8 mm	20	010306221
	green FEM6 2.8 mm	20	010312515
	white FEM6 2.8 mm	20	010331220
	beige FEM6 2.8 mm	20	019836817
	black FEM6 2.8 mm	20	010700525
Separator end section	grey SCF6 3 mm	20	011870703
Assembled jumper bar	2 poles BJMI5 32 A	10	017666300
(with IP20 protection)	3 poles BJMI5 32 A	10	017666401
	4 poles BJMI5 32 A	10	017666502
	5 poles BJMI5 32 A	10	017666603
	10 poles BJMI5 32 A	10	017666704
Shield connector	CBM5 0.5 mm	20	017874514
	CBM5 0.5 mm	20	017874615

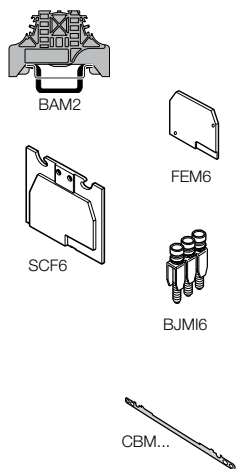

M 4/6.P - 4 mm² ground block with rail contact - 6 mm .238" spacing

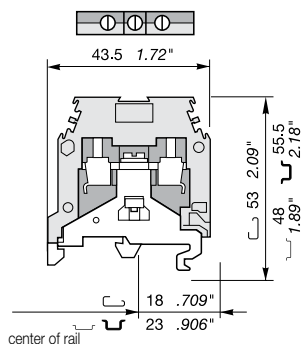

M 4/6.P

Characteristics		IEC		UL	CSA
		NFC	DIN		
Wire size	Solid	0.2 - 4 mm ²		22-10 AWG	24-10 AWG
mm ² / AWG	Stranded	0.22 - 4 mm ²			
Short circuit current	A / s	480A/1s			
Rated wire size	mm ² / AWG	4 mm ²		10 AWG	10 AWG
Wire stripping length	mm / inches	9.5 mm / .37"			
Recommended torque	Nm / lb.in	0.5-0.8 Nm / 4.4-7.1 lb.in			

Selection

Description	Type	Packaging	Catalog number
Ground block green/yellow	M 4/6.P	50	016511316
Mounting on DIN 3 rail without screw			
Ground block green/yellow	D 2,5/5.P	50	016580901

Accessories

Description	Type	Packaging	Catalog number
End section	yellow FEM6 2.8 mm	20	010306221
Separator end section	grey SCF6 3 mm	20	011870703

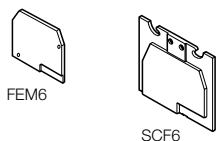

Feed through and ground terminal blocks

Single pole, multiclamp terminal blocks

Screw clamp, DIN 1-3

M 4/6.3A - 4 mm² blocks - 6 mm .238" spacing

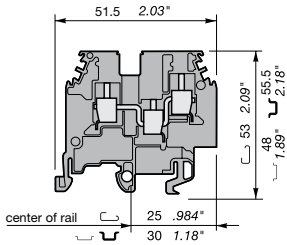

M 4/6.3A

Characteristics		IEC		UL	CSA
		NFC	DIN		
Wire size	Solid	0.2 - 4 mm ²		22-10 AWG	12 AWG
mm ² / AWG	Stranded	0.22 - 4 mm ²			
Voltage	V	800		600	600
Current	A	32		20	25
Rated wire size	mm ² / AWG	4 mm ²		10 AWG	12 AWG
Wire stripping length	mm / inches			9 mm / .37"	
Recommended torque	Nm / lb.in			0.5-0.8 Nm / 4.4-7.1 lb.in	

Selection

Description	Type	Packaging	Catalog number
Standard block grey	M 4/6.3A	50	011546820
Standard block blue	M 4/6.3A.N	50	012546822
Standard block beige	M 4/6.3A	50	019546821

Accessories

Description	Type	Packaging	Catalog number
End stop	BAM2 9.9 mm	50	020635116
End section	grey FEM3A 3 mm	20	011657615
	blue FEM3A 3 mm	20	012657617
	yellow FEM3A 3 mm	20	010386220
Assembled jumper bar (with IP20 protection)	2 poles BJMI6 32 A	10	017666300
	3 poles BJMI6 32 A	10	017666401
	4 poles BJMI6 32 A	10	017666502
	5 poles BJMI6 32 A	10	017666603
	10 poles BJMI6 32 A	10	017666704

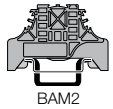

BAM2



FEM3A



BJMI6

M 4/6.4A - 4 mm² blocks - 6 mm .238" spacing

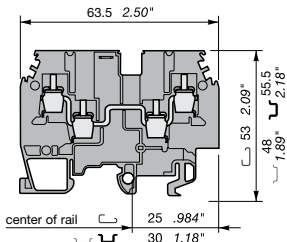

M 4/6.4A

Characteristics		IEC		UL	CSA
		NFC	DIN		
Wire size	Solid	0.2 - 4 mm ²		22-10 AWG	12 AWG max.
mm ² / AWG	Stranded	0.22 - 4 mm ²			
Voltage	V	800		600	600
Current	A	32		20	25
Rated wire size	mm ² / AWG	4 mm ²		10 AWG	12 AWG
Wire stripping length	mm / inches			9.5 mm / .37"	
Recommended torque	Nm / lb.in			0.5-0.8 Nm / 4.4-7.1 lb.in	

Selection

Description	Type	Packaging	Catalog number
Standard block grey	M 4/6.4A	50	011547923
Standard block blue	M 4/6.4A.N	50	012547925
Standard block beige	M 4/6.4A	50	019547924

Accessories

Description	Type	Packaging	Catalog number
End stop	BAM2 9.9 mm	50	020635116
End section	grey FEM4A 3 mm	20	011662922
	blue FEM4A 3 mm	20	012662924
	yellow FEM4A 3 mm	20	010386321
Assembled jumper bar (with IP20 protection)	2 poles BJMI6 32 A	10	017666300
	3 poles BJMI6 32 A	10	017666401
	4 poles BJMI6 32 A	10	017666502
	5 poles BJMI6 32 A	10	017666603
	10 poles BJMI6 32 A	10	017666704

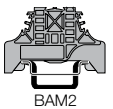

BAM2



FEM4A



BJMI6

Feed through and ground terminal blocks

Screw clamp, DIN 1-3

M 6/8 - 6 mm² blocks - 8 mm .315" spacing

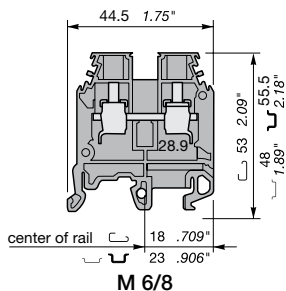

Characteristics		IEC		UL	CSA
		NFC	DIN		
Wire size	Solid	0.5 - 10 mm ²		22-8 AWG	24-8 AWG
mm ² / AWG	Stranded	0.5 - 6 mm ²			
Voltage	V	800		600	600
Current	A	41		50	55
Short circuit current (M 6/8.PI)	A / s	720A/1s			
Rated wire size	mm ² / AWG	6 mm ²		8 AWG	8 AWG
Wire stripping length	mm / inches			12mm / .47"	
Recommended torque	Nm / lb.in			0.8-1 Nm / 7.1-8.9 lb.in	

Selection

Description	Type	Packaging	Catalog number
Standard block grey	M 6/8	50	011511811
Standard block blue	M 6/8.N	50	012511813
Standard block orange	M 6/8	50	010500422
Standard block yellow	M 6/8	50	010511820
Standard block beige	M 6/8	50	019511812
Standard block black	M 6/8	50	040023915
Standard block red	M 6/8	50	040018621
Standard block white	M 6/8	50	040018722
Standard block green	M 6/8	50	010512822

Accessories

Description	Type	Packaging	Catalog number
End stop	BAM2 9.9 mm	50	020635116
End section	grey FEM6 2.8 mm	20	011836816
	blue FEM6 2.8 mm	20	012836810
	orange FEM6 2.8 mm	20	010312616
	yellow FEM6 2.8 mm	20	010306221
	green FEM6 2.8 mm	20	010312515
	white FEM6 2.8 mm	20	010331220
	beige FEM6 2.8 mm	20	019836817
	black FEM6 2.8 mm	20	010700525
Separator end section	grey SCF6 3 mm	20	011870703
Assembled jumper bar	2 poles BJMI8 41 A	10	017666916
(with IP20 protection)	3 poles BJMI8 41 A	10	017667013
	4 poles BJMI8 41 A	10	017667100
	5 poles BJMI8 41 A	10	017667201
	10 poles BJMI8 41 A	10	017667302

M 6/8.P - 6 mm² ground block with rail contact - 8 mm .315" spacing

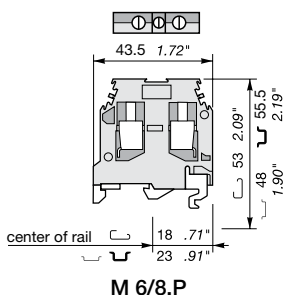

Characteristics		IEC		UL	CSA
		NFC	DIN		
Wire size	Solid	0.5 - 10 mm ²		22-8 AWG	24-8 AWG
mm ² / AWG	Stranded	0.5 - 6 mm ²			
Short circuit current (M 6/8.PI)	A / s	720A/1s			
Rated wire size	mm ² / AWG	6 mm ²		8 AWG	8 AWG
Wire stripping length	mm / inches			12mm / .47"	
Recommended torque	Nm / lb.in			0.8-1 Nm / 7.1-8.9 lb.in	

Selection

Description	Type	Packaging	Catalog number
Ground block green/yellow	M 6/8.P	50	016511417
Mounting on rail DIN 3 without screw			
Ground block green/yellow	D 6/8.P	50	016583021

Accessories

Description	Type	Packaging	Catalog number
End section	yellow FEM6 2.8 mm	20	010306221
Separator end section	grey SCF6 3 mm	20	011870703

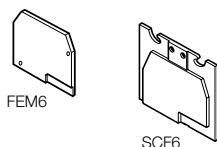
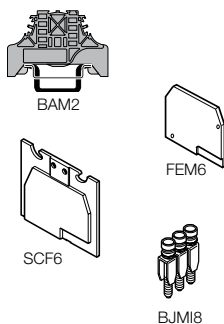

Feed through and ground terminal blocks

Screw clamp, DIN 1-3

M 10/10 - 10 mm² blocks - 10 mm .394" spacing

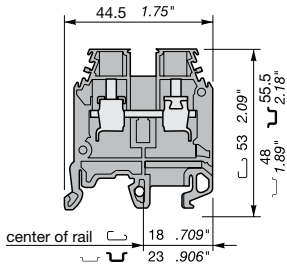

M 10/10

Characteristics	IEC		UL	CSA
	NFC	DIN		
Wire size	Solid	0.5 - 16 mm ²	20-6 AWG	18-6 AWG
mm ² / AWG	Stranded	0.5 - 10 mm ²		
Voltage	V	800	600	600
Current	A	57	65	70
Short circuit current (M 10/10.PI)	A / s	1200A/1s		
Rated wire size	mm ² / AWG	10mm ²	6 AWG	6 AWG
Wire stripping length	mm / inches		12 mm / .47"	
Recommended torque	Nm / lb.in	1.2-1.4 Nm / 10.6-12.4 lb.in		

Selection

Description	Type	Packaging	Catalog number
Standard block grey	M 10/10	50	011512017
Standard block blue	M 10/10.N	50	012512011
Standard block yellow	M 10/10	50	010512026
Standard block beige	M 10/10	50	019512010
Standard block black	M 10/10	50	040018803
Standard block red	M 10/10	50	040018904
Standard block white	M 10/10	50	040019001

Accessories

Description	Type	Packaging	Catalog number
End stop	BAM2 9.9 mm	50	020635116
End section	grey FEM6 2.8 mm	20	011836816
	blue FEM6 2.8 mm	20	012836810
	orange FEM6 2.8 mm	20	010312616
	yellow FEM6 2.8 mm	20	010306221
	green FEM6 2.8 mm	20	010312515
	white FEM6 2.8 mm	20	010331220
	black FEM6 2.8 mm	20	010700525
	beige FEM6 2.8 mm	20	019836817
Separator end section	grey SCF6 3 mm	20	011870703
Assembled jumper bar	2 poles BJMI10 57 A	10	017667504
(with IP20 protection)	3 poles BJMI10 57 A	10	017667605
	4 poles BJMI10 57 A	10	017667706
	5 poles BJMI10 57 A	10	017667817
	10 poles BJMI10 57 A	10	017667910

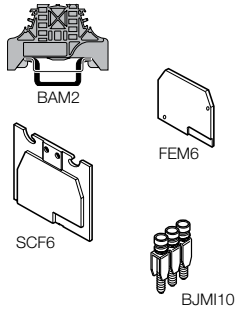

M 10/10.P - 10 mm² ground / block with rail contact - 10 mm .394" spacing

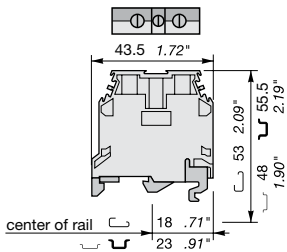

M 10/10.P

Characteristics	IEC		UL	CSA
	NFC	DIN		
Wire size	Solid	0.5 - 16 mm ²	20-6 AWG	18-6 AWG
mm ² / AWG	Stranded	0.5 - 10 mm ²		
Short circuit current	A / s	1200A/1s		
Rated wire size	mm ² / AWG	10mm ²	6 AWG	6 AWG
Wire stripping length	mm / inches		12 mm / .47"	
Recommended torque	Nm / lb.in	1.2-1.4 Nm / 10.6-12.4 lb.in		

Selection

Description	Type	Packaging	Catalog number
Ground block green/yellow	M 10/10.P	50	016511510

Accessories

Description	Type	Packaging	Catalog number
Separator end section	grey SCF6 3 mm	20	011870703

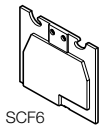

Feed through and ground terminal blocks

Screw clamp, DIN 1-3

M 16/12 - 16 mm² blocks - 12 mm .473" spacing

Characteristics

		IEC		UL	CSA
		NFC	DIN		
Wire size	Solid	0.5 - 25 mm ²		18-6 AWG	8-4 AWG
mm ² / AWG	Stranded	0.5 - 16 mm ²			
Voltage	V	800		600	600
Current	A	86		85	100
Short circuit current (M 16/12.PI)	A / s	1920A/1s			
Rated wire size	mm ² / AWG	16mm ²		6 AWG	4 AWG
Wire stripping length	mm / inches			14 mm / .55"	
Recommended torque	Nm / lb.in			1.2-1.4 Nm / 10.6-12.4 lb.in	

Selection

Description	Type	Packaging	Catalog number
Standard block grey	M 16/12	50	011512914
Standard block blue	M 16/12.N	50	012512916
Standard block yellow	M 16/12	50	010512923
Standard block beige	M 16/12	50	019512915
Standard block black	M 16/12	20	040019126
Standard block red	M 16/12	20	040019227
Standard block white	M 16/12	20	040019320

Accessories

Description	Type	Packaging	Catalog number
End stop	BAM2 9.9 mm	50	020635116
End section	grey FEM12 3 mm	20	011861801
	blue FEM12 3 mm	20	012861803
	yellow FEM12 3 mm	20	010306524
	beige FEM12 3 mm	20	019861802
Separator end section	grey SCF12 3 mm	20	011870703
Assembled jumper bar (with IP20 protection)	2 poles BJMI12 76 A	10	017962606
	3 poles BJMI12 76 A	10	017962810
	4 poles BJMI12 76 A	10	017962911
	5 poles BJMI12 76 A	10	017963016
	10 poles BJMI12 76 A	10	017963103

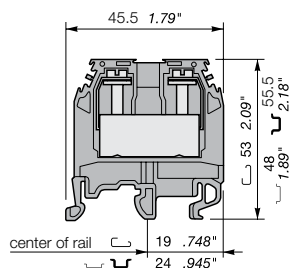

M 16/12

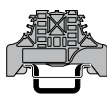

BAM2



FEM12

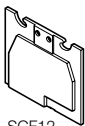

SCF12



BJMI12

M 16/12.P - 16 mm² ground block with rail contact - 12 mm .473" spacing

Characteristics

		IEC		UL	CSA
		NFC	DIN		
Wire size	Solid	4 - 25 mm ²		14-4 AWG	10-6 AWG
mm ² / AWG	Stranded	4 - 16 mm ²			
Short circuit current	A / s	1920A/1s			
Rated wire size	mm ² / AWG	16mm ²		4 AWG	6 AWG
Wire stripping length	mm / inches			14 mm / .55"	
Recommended torque	Nm / lb.in			1.2-1.4 Nm / 10.6-12.4 lb.in	

Selection

Description	Type	Packaging	Catalog number
Ground block green/yellow	M 16/12.P	20	016513023

Accessories

Description	Type	Packaging	Catalog number
Separator end section	grey SCFM6 3 mm	20	011482505

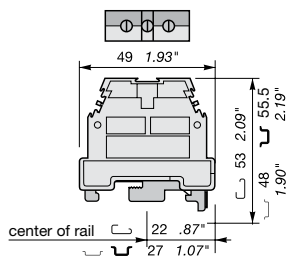

M 16/12.P

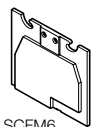

SCFM6

Feed through and ground terminal blocks

Screw clamp, DIN 1-3

M 35/16 - 35 mm² blocks - 16 mm .630" spacing

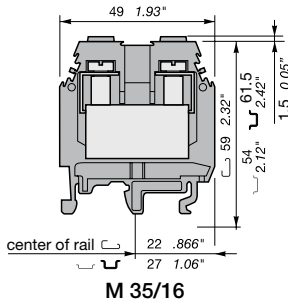

Characteristics		IEC		UL	CSA
		NFC	DIN		
Wire size	Solid	1 - 50 mm ²		10-0 AWG	10-0 AWG
mm ² / AWG	Stranded	1 - 35 mm ²			
Voltage	V	800		600	600
Current	A	125		150	140
Short circuit current (M 35/16.PI)	A / s	4200A/1s			
Rated wire size	mm ² / AWG	35 mm ²		0 AWG	0 AWG
Wire stripping length	mm / inches			17 mm / .669"	
Recommended torque	Nm / lb.in			2.8-3 Nm / 24.9-26.7 lb.in	

Selection

Description	Type	Packaging	Catalog number
Standard block grey	M 35/16	20	011512407
Standard block blue	M 35/16.N	20	012512401
Standard block yellow	M 35/16	20	010512416
Standard block beige	M 35/16	20	019512400
Standard block black	M 35/16	20	040019421
Standard block red	M 35/16	20	040019522
Standard block white	M 35/16	20	040019623

Accessories

Description	Type	Packaging	Catalog number
End stop	BAM2 9.9 mm	50	020635116
Assembled jumper bar 2 poles	BJMI16 110 A	10	020621700
(with IP20 protection) 3 poles	BJMI16 110 A	10	020621811
4 poles	BJMI16 110 A	10	020621912
5 poles	BJMI16 110 A	10	020622017
10 poles	BJMI16 110 A	10	020622104

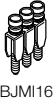
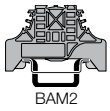

M 35/16.P - 35 mm² ground block with rail contact - 16 mm .630" spacing

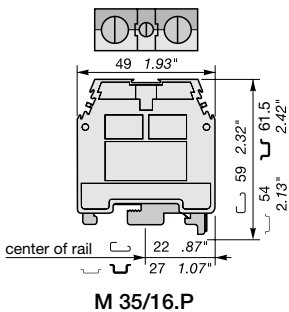

Characteristics		IEC		UL	CSA
		NFC	DIN		
Wire size	Solid	4 - 50 mm ²		10-0 AWG	10-0 AWG
mm ² / AWG	Stranded	4 - 35 mm ²			
Short circuit current	A / s	4200A/1s			
Rated wire size	mm ² / AWG	35 mm ²		0 AWG	0 AWG
Wire stripping length	mm / inches			17 mm / .67"	
Recommended torque	Nm / lb.in			2.8-3 Nm / 24.9-26.7 lb.in	

Selection

Description	Type	Packaging	Catalog number
Ground block green/yellow	M 35/16.P	20	016511114

Feed through and ground terminal blocks

Screw clamp, 𐀀 𐀁 DIN 1-3

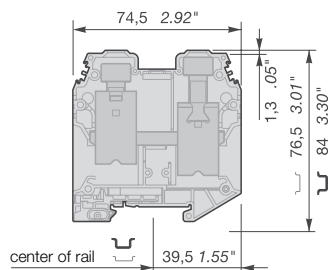

D 70/22 - 22 mm² blocks - 22 mm .868" spacing

Characteristics		IEC		UL	CSA
		NFC	DIN		
Wire size	Solid	16 - 95 mm ²			
mm ² / AWG	Stranded	16 - 70 mm ²		2-0000 AWG	2-0000 AWG
Voltage	V	1000		600	600
Current	A	192		159	159
Short circuit current (M 35/16.PI)	A / s	4200A/1s			
Rated wire size	mm ² / AWG	70 mm ²		0 AWG	0 AWG
Wire stripping length	mm / inches			25 mm ²	
Recommended torque	Nm / lb.in			6-7 Nm / 53.4-62.3 lb.in	

Selection

Description	Type	Packaging	Catalog number
Standard block grey	D 70/22	10	1SNA400305R1000
Standard block blue	D 70/22.N	10	1SNA400306R1100
Standard block yellow	D 70/22	10	1SNA400789R0000

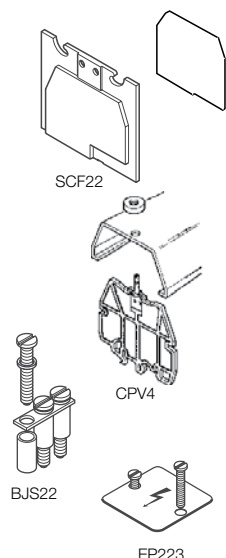

Accessories

Description	Type	Packaging	Catalog number		
End stop	Closed block	-	-		
grey	SCF22	th. 3.0 mm	20	011385116	
Separator end section	beige	SCF22 V0	th. 3.0 mm	20	1SNA193851R1700
Separator end section	grey	SCFCV4 ①	th. 3.0 mm	10	011679713
for cover CPV	beige	SCFCV4 V0 ①	th. 3.0 mm	10	1SNA196797R1400
Protective cover		CPV4 (for SCFCV4...)		1	017679121
Jumper bar not assembled	BJS22 ②	2 poles	10	017331621	
	BJS22 ②	3 poles	10	017331722	
	BJS22 ②	5 poles	10	017331803	
	BJS22 ②	10 poles	10	017331904	
Screw for BJS		VSJ51		20	017332001
Washer for BJS		RDJ51		20	017333120
Protection label	EP223	3 blocks	10	017332724	
	EP224	4 blocks	10	017332805	
Screw for protection label		VSP22		20	1SNA400252R1200

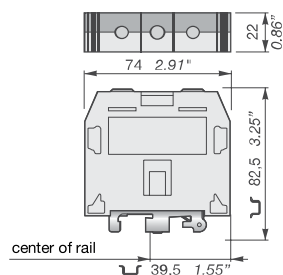

D 70/22.P - 22 mm² blocks - 22 mm .866" spacing

Characteristics		IEC		UL	CSA
		NFC	DIN		
Wire size	Solid	16 - 95 mm ²		4-00 AWG	4-00 AWG
mm ² / AWG	Stranded	16 - 70 mm ²			
Voltage	V	1000		600	600
Current	A	232			
Short circuit current (M 35/16.PI)	A / s	8400A/1s		8088 A / 1s	8088 A / 1s
Rated wire size	mm ² / AWG	70 mm ²		0 AWG	0 AWG
Wire stripping length	mm / inches			25 mm	
Recommended torque	Nm / lb.in			6-7 Nm / 52-61 lb.in	

Selection

Description	Type	Packaging	Catalog number
Green/yellow	D 70/22.P	10	1SNA400772R1300

Accessories

Description	Type	Packaging	Catalog number
End section	yellow	Closed block	-
Separator end section	grey	Closed block	-

① End sections and circuit separators snapped on rails.
 ② Use of these accessories requires the user to cut out the partition.

Feed through and ground terminal blocks

Screw clamp, DIN 1-3

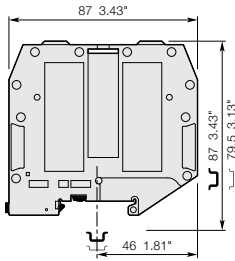

D 95/26 - 26 mm² blocks - 26 mm 1.02" spacing

Characteristics		IEC		UL	CSA
		NFC	DIN		
Wire size mm ² / AWG	Solid	35 - 120 mm ²		2-0000 AWG	2-0000 AWG
	Stranded	35 - 95 mm ²			
Voltage	V	1000		600	600
Current	A	232		230	230
Short circuit current (M 35/16.PI)	A / s	4200A/1s			
Rated wire size	mm ² / AWG	95 mm ²		0 AWG	0 AWG
Wire stripping length	mm / inches			26 mm	
Recommended torque	Nm / lb.in			9.25 Nm / 81.7 lb.in	

Selection

Description	Type	Packaging	Catalog number
Standard block grey	D95/26	10	1SNA400370R2400
Standard block blue	D95/26.N	10	1SNA400371R1100
Standard block yellow	D95/26.YL	10	1SNA400791R0000



JB26-2

Accessories

Description	Type	Packaging	Catalog number
End stop	Closed block	-	-
Jumper bar	JB26-2 ⊕ 2 poles	5	1SNK926302R0000
	JB26-3 ⊕ 3 poles	5	1SNK926303R0000
	JB26-5 ⊕ 5 poles	5	1SNK926305R0000
	JB26-10 ⊕ 10 poles	5	1SNK926310R0000

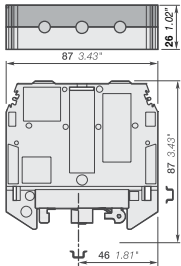

D 95/26.P - 26 mm² blocks - 26 mm 1.02" spacing

Characteristics		IEC		UL	CSA
		NFC	DIN		
Wire size mm ² / AWG	Solid	35 - 120 mm ²		2-0000 AWG	2-0000 AWG
	Stranded	35 - 95 mm ²			
Voltage	V	1000		600	600
Current	A	232			
Short circuit current (M 35/16.PI)	A / s	11400A/1s		12840 A/1s	12840 A/1s
Rated wire size	mm ² / AWG	95 mm ²		0 AWG	0 AWG
Wire stripping length	mm / inches			26 mm	
Recommended torque	Nm / lb.in			9.25 Nm / 81.7 lb.in	

Selection

Description	Type	Packaging	Catalog number
Green/yellow	D95/26.P	10	1SNA400620R1700

Accessories

Description	Type	Packaging	Catalog number
End section yellow	Closed block	-	-
Separator end section grey	Closed block	-	-

⊕ Use of these accessories requires the user to cut out the partition.

Feed through terminal blocks

Double-deck

Screw clamp, 2 1/2 DIN 1-3

MA 2,5/5.D2 - 2.5 mm² blocks - 5 mm .200" spacing

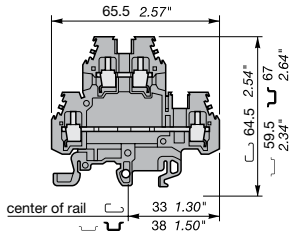

MA 2,5/5.D2

Characteristics	IEC		UL	CSA
	NFC	DIN		
Wire size	Solid	0.2 - 4 mm ²	22-12 AWG	20-12 AWG
mm ² / AWG	Stranded	0.22 - 2.5 mm ²		
Voltage	V	630	300	300
Current	A	24	20	25
Rated wire size	mm ² / AWG	2.5 mm ²	12 AWG	12 AWG
Wire stripping length	mm / inches	9 mm / .354"		
Recommended torque	Nm / lb.in	0.4-0.6 Nm / 3.5-5.3 lb.in		

M 4/6.D2 - 4 mm² blocks - 6 mm .238" spacing

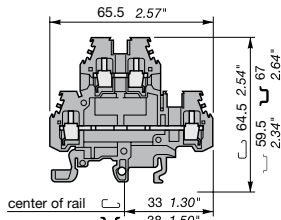

M 4/6.D2

Characteristics	IEC		UL	CSA
	NFC	DIN		
Wire size	Solid	0.2 - 4 mm ²	22-12 AWG	24-12 AWG
mm ² / AWG	Stranded	0.22 - 4 mm ²		
Voltage	V	800	600	300
Current	A	32	20	25
Rated wire size	mm ² / AWG	4 mm ²	12 AWG	12 AWG
Wire stripping length	mm / inches	8.5 mm / .33"		
Recommended torque	Nm / lb.in	0.5-0.8 Nm / 4.4-7.1 lb.in		

M 6/8.D2 - 6 mm² blocks - 8 mm .315" spacing

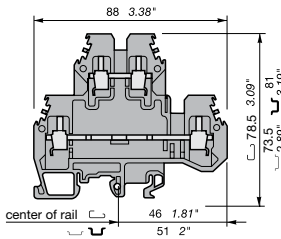

M 6/8.D2

Characteristics	IEC		UL	CSA
	NFC	DIN		
Wire size	Solid	0.5 - 10 mm ²	18-8 AWG	8 AWG
mm ² / AWG	Stranded	0.5 - 6 mm ²		
Voltage	V	800	600	600
Current	A	41	50	45
Rated wire size	mm ² / AWG	6 mm ²	8 AWG	8 AWG
Wire stripping length	mm / inches	12 mm / .47"		
Recommended torque	Nm / lb.in	0.8-1 Nm / 7.1-8.9 lb.in		

MA 2,5/5.D2 Selection

Description	Type	Packaging	Catalog number
Standard block grey	MA 2,5/5.D2	50	011549013
Standard block blue	MA 2,5/5.D2.N	50	012549015
Standard block beige	MA 2,5/5.D2	50	019549014

M 4/6.D2 Selection

Standard block grey	M 4/6.D2	50	011527122
Standard block beige	M 4/6.D2	50	019527123
Standard block green	M 4/6.D2	50	010504421
Standard block white	M 4/6.D2	50	010504623
Standard block black	M 4/6.D2	50	010504724
Standard block red	M 4/6.D2	50	010504805
Standard block orange	M 4/6.D2	50	010504906
Standard block yellow	M 4/6.D2	50	010504522

M 6/8.D2 Selection

Standard block grey	M 6/8.D2	50	011550112
Standard block beige	M 6/8.D2	50	019550113

Accessories

Description	Type	Packaging	Catalog number
End stop	BADH 12 mm	50	011690027
	BAMH 9.1 mm	50	011483600
End section	grey FEM6D 1 mm ⊕	20	011849923
	blue FEM6D 1 mm ⊕	20	012849925
	grey FEM8D1 1 mm ⊕	20	011665625
	grey FEM8D2 4 mm ⊕	20	011665726
Separator end section	grey SCF6D 1 mm ⊕	20	011849517
Assembled jumper bar (with IP20 protection)	2 poles BJMI5D 24 A ⊕	10	017673621
	3 poles BJMI5D 24 A ⊕	10	017673722
	4 poles BJMI5D 24 A ⊕	10	017673803
	5 poles BJMI5D 24 A ⊕	10	017673904
	10 poles BJMI5D 24 A ⊕	10	017674011
	Assembled jumper bar (with IP20 protection)	2 poles BJMI6D 32 A ⊕	10
3 poles BJMI6D 32 A ⊕		10	017966921
4 poles BJMI6D 32 A ⊕		10	017967026
5 poles BJMI6D 32 A ⊕		10	017967113
10 poles BJMI6D 32 A ⊕		10	017967214
Assembled jumper bar (with IP20 protection)		2 poles BJMI8 41 A ⊕	10
	3 poles BJMI8 41 A ⊕	10	017667013
	4 poles BJMI8 41 A ⊕	10	017667100
	5 poles BJMI8 41 A ⊕	10	017667201
	10 poles BJMI8 41 A ⊕	10	017667302
	Shield connector	CBM5D 0.5 mm ⊕	50

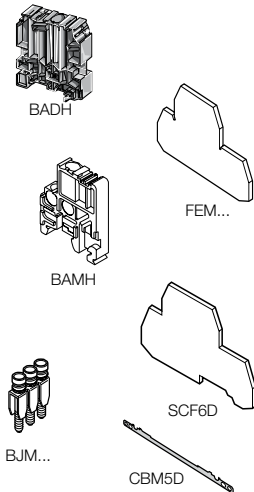

⊕ Only for MA 2,5/5.D2...
 ⊗ Only for M 4/6.D2...
 ⊙ Only for M 6/8.D2...

Feed through terminal blocks

Triple - deck

Screw clamp,  DIN 3

D 4/6.T3 - 4 mm² blocks - 6 mm .238" spacing

Characteristics

		IEC		UL	CSA
		NFC	DIN		
Wire size	Solid	0.2 - 4 mm ²		22-12 AWG	22-12 AWG
mm ² / AWG	Stranded	0.22 - 4 mm ²			
Voltage	V	500		300	300
Current	A	32		20	20
Rated wire size	mm ² / AWG	4 mm ²		12 AWG	12 AWG
Wire stripping length	mm / inches	9.5 mm / .37"			
Recommended torque	Nm / lb.in	0.5-0.8 Nm / 4.4-7.1 lb.in			

Selection – No end section needed (closed block)

Description	Type	Packaging	Catalog number
Standard block grey	D 4/6.T3	25	029968301

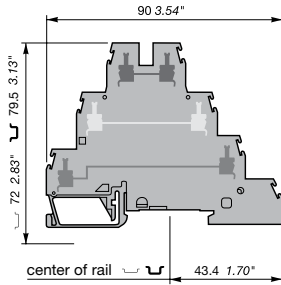

M 4/6.T3

M 4/6.T3.P - 4 mm² block - 6 mm .238" spacing

Characteristics

		IEC		UL	CSA
		NFC	DIN		
Wire size	Solid	0.2 - 4 mm ²		22-12 AWG	22-12 AWG
mm ² / AWG	Stranded	0.22 - 4 mm ²			
Voltage	V	500		300	300
Current	A	32		20	20
Short circuit current	A/s	480 A/1s			
Rated wire size	mm ² / AWG	4 mm ²		12 AWG	12 AWG
Wire stripping length	mm / inches	9.5 mm / .37"			
Recommended torque	Nm / lb.in	0.5-0.8 Nm / 4.4-7.1 lb.in			

Selection – No end section needed (closed block)

Description	Type	Packaging	Catalog number
Standard block grey	M 4/6.T3.P	25	029968402

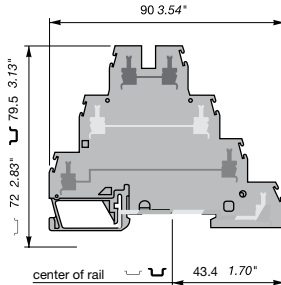

M 4/6.T3.P

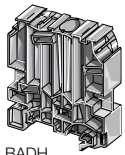

BADH



BJM62

Accessories

Description	Type	Packaging	Catalog number	
End stop	BADH 12 mm	50	011690027	
Assembled jumper bar (without IP20 protection)	2 poles 3 poles 4 poles 5 poles 10 poles	BJM62 41 A BJM62 41 A BJM62 41 A BJM62 41 A BJM62 41 A	10 10 10 10 10	017321726 017321807 017321900 017322122 017322627

Three level sensor

Terminal blocks without ground connection

Screw clamp, U DIN 3

D 2,5/6.D - 2.5 mm² blocks - 6 mm .238" spacing

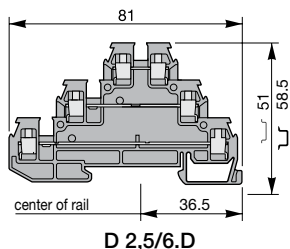

Characteristics		IEC		UL	CSA
		NFC	DIN		
Wire size	Solid	0.2 - 2.5 mm ²		20-12 AWG	22-14 AWG
mm ² / AWG	Stranded	0.22 - 2.5 mm ²			
Voltage	V	380 Gr.c		300	300
Current	A	22		26	20
Rated wire size	mm ² / AWG	2.5 mm ²		12 AWG	14 AWG
Wire stripping length	mm / inches	6 mm / .24"			
Recommended torque	Nm / lb.in	0.4-0.6 Nm / 3.5-5.3 lb.in			

Selection

Description	Type	Packaging	Catalog number
Three level block for sensor grey	D 2,5/6	25	011554111

Accessories

Description	Type	Packaging	Catalog number	
End stop	BAMH 9.1 mm	50	011483600	
End section grey	FED3E 3 mm	20	011677120	
Assembled jumper bar (without IP20 protection)	2 poles	BJD6 22 A	10	017802425
	3 poles	BJD6 22 A	10	017802526
	4 poles	BJD6 22 A	10	017802627
	5 poles	BJD6 22 A	10	017802720
	10 poles	BJD6 22 A	10	017803225

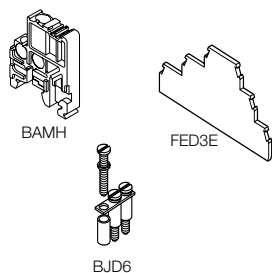

D 2,5/6.DL - 2.5 mm² blocks - 6 mm .238" spacing

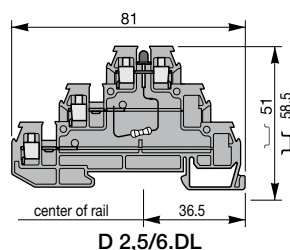

Characteristics		IEC		UL	CSA
		NFC	DIN		
Wire size	Solid	0.2 - 2.5 mm ²		20-12 AWG	22-14 AWG
mm ² / AWG	Stranded	0.22 - 2.5 mm ²			
Voltage	V	380 Gr.c		300 Ⓞ	300 Ⓞ
Current	A	22		26	20
Rated wire size	mm ² / AWG	2.5 mm ²		12 AWG	14 AWG
Wire stripping length	mm / inches	6 mm / .24"			
Recommended torque	Nm / lb.in	0.4-0.6 Nm / 3.5-5.3 lb.in			

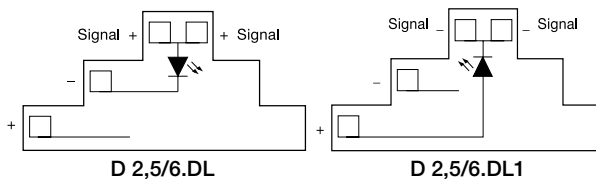
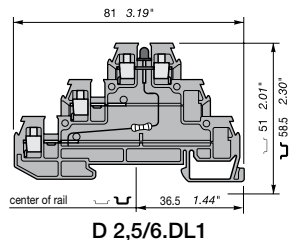

Selection

Description	Type	Packaging	Catalog number
Three level block for sensor with red LED indication grey	D 2,5/6.DL	25	011553705
LED indication grey	D 2,5/6.DL1	25	011553816

Accessories

Description	Type	Packaging	Catalog number	
End stop	BAMH 9.1 mm	50	011483600	
End section grey	FED3E 3 mm	20	011677120	
Assembled jumper bar (without IP20 protection)	2 poles	BJD6 22 A	10	017802425
	3 poles	BJD6 22 A	10	017802526
	4 poles	BJD6 22 A	10	017802627
	5 poles	BJD6 22 A	10	017802720
	10 poles	BJD6 22 A	10	017803225

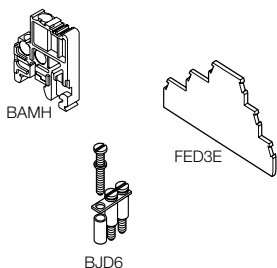

Ⓞ 24 VDC on LED circuit.

Heavy duty switch terminal blocks

Screw clamp,  DIN 1-3

M 6/8.SNB - 6 mm² blocks - 8 mm .315" spacing - blade switching

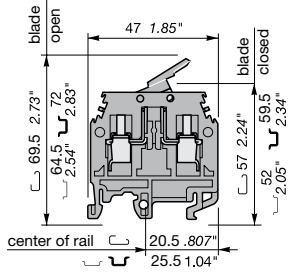

M 6/8.SNB

Characteristics		IEC		UL	CSA
		NFC	DIN		
Wire size mm ² / AWG	Solid	0.5 - 10 mm ²		22-8 AWG	20-12 AWG
	Stranded	0.5 - 6 mm ²			
Voltage	V	400		300	300
Current	A	15		20	10
Rated wire size	mm ² / AWG	6mm ²		10 AWG	12 AWG
Wire stripping length	mm / inches	12 mm / .47"			
Recommended torque	Nm / lb.in	0.8-1 Nm / 7.1-8.9 lb.in			

Selection

Description	Type	Packaging	Catalog number
Standard block grey	M 6/8.SNB	50	011568825

Accessories

Description	Type	Packaging	Catalog number
End stop	BAM2 9.9 mm	50	020635116
End section	grey FEM8 3 mm	20	011337326
	orange FEM8 3 mm	20	010323002
Separator end section	grey SCFM6 3 mm	20	011482505

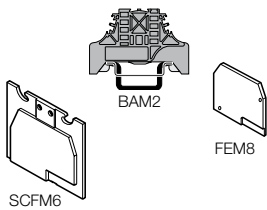

10

M 6/8.STP - 6 mm² blocks - 8 mm .315" spacing - push-turn knob switching

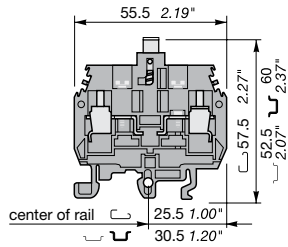

M 6/8.STP

Characteristics		IEC		UL	CSA
		NFC	DIN		
Wire size mm ² / AWG	Solid	0.5 - 10 mm ²		22-8 AWG	8 AWG
	Stranded	0.5 - 6 mm ²			
Voltage	V	500		600	600
Current	A	15		40	15
Rated wire size	mm ² / AWG	6mm ²		8 AWG	8 AWG
Wire stripping length	mm / inches	11 mm / .433"			
Recommended torque	Nm / lb.in	0.8-1 Nm / 7.1-8.9 lb.in			

Selection

Description	Type	Packaging	Catalog number
Yellow plunger	M 6/8.STP	25	011527720
Orange plunger	M 6/8.STP1	25	011552915

Accessories

Description	Type	Packaging	Catalog number
End stop	BAM2 9.9 mm	50	020635116
End section	grey FEMT1 2.8 mm	50	011313702

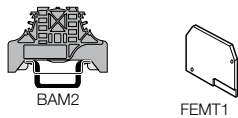

Heavy duty switch and fuse holder terminal blocks

Double-deck

Screw clamp, DIN 1 - DIN 3

M 4/6.D2.SNBT - 4 mm² blocks - 6 mm .238" spacing - blade switch

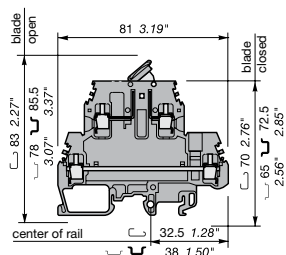

M 4/6.D2.SNBT

Characteristics		IEC		UL	CSA
		NFC	DIN		
Wire size mm ² / AWG	Solid	0.5 - 4 mm ²		24-12 AWG	22-12 AWG
	Stranded	0.5 - 4 mm ²			
Voltage	V	400		300	300
Current	A	10		15	15
Rated wire size	mm ² / AWG	4 mm ²		12 AWG	12 AWG
Wire stripping length	mm / inches	9.5 mm / .374"			
Recommended torque	Nm / lb.in	0.5-0.6 Nm / 4.4-5.3 lb.in			

Selection

Description	Type	Packaging	Catalog number
Standard block grey	M 4/6.D2.SNBT	50	011556115

Accessories

Description	Type	Packaging	Catalog number
End stop	BADH 12 mm	50	011690027
	BAMH 9.1 mm	50	011483600
End section grey	FEMS6D 1.5 mm	20	011659105
Assembled jumper bar (without IP20 protection)	2 poles BJM16D 32 A ⊕	10	017966820
	3 poles BJM16D 32 A ⊕	10	017966921
	4 poles BJM16D 32 A ⊕	10	017967026
	5 poles BJM16D 32 A ⊕	10	017967113
	10 poles BJM16D 32 A ⊕	10	017967214
Shield connector	CBD2S	50	017840814

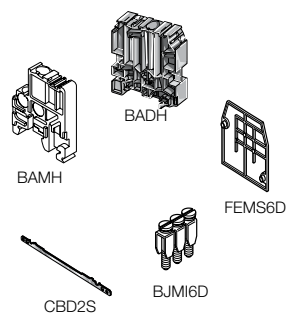

M 4/8.D2.SF - for fuses 5x20 mm .197x.787 in. and 5x25 mm .197x.984 in. - 4 mm² blocks - 8 mm .315" spacing

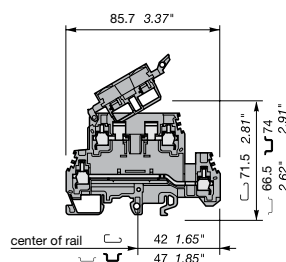

M 4/8.D2.SF

Characteristics		IEC		UL	CSA
		NFC	DIN		
Wire size mm ² / AWG	Solid	0.5 - 6 mm ²		24-12 AWG	24-12 AWG
	Stranded	0.5 - 4 mm ²			
Voltage	V	630 ⊕		300 ⊕	300 ⊕
Current	A	6.3		20	20
Rated wire size	mm ² / AWG	4 mm ²		12 AWG	12 AWG
Wire stripping length	mm / inches	9.5 mm / .37"			
Recommended torque	Nm / lb.in	0.5-0.8 Nm / 4.4-7.1 lb.in			

Selection

Description	Type	Packaging	Catalog number
Standard block grey	M 4/8.D2.SF	50	011560421
Standard block beige	M 4/8.D2.SF	50	019560422

Accessories

Description	Type	Packaging	Catalog number
End stop	BADH 12 mm	50	011690027
	BAMH 9.1 mm	50	011483600
End section grey	FEM8D2S 1.5 mm	20	011691307
Assembled jumper bar (without IP20 protection)	2 poles BJM8D 41 A ⊕	10	016852005
	3 poles BJM8D 41 A ⊕	10	016852122
	4 poles BJM8D 41 A ⊕	10	016852223
	5 poles BJM8D 41 A ⊕	10	016852824
	10 poles BJM8D 41 A ⊕	10	016897400
Shield connector	CBD2S	50	017840814

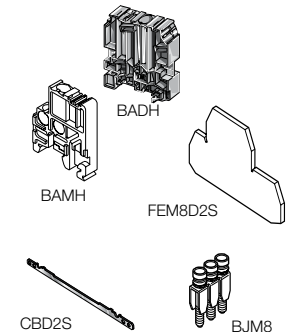

⊕ Lower deck only.
 ⊕ Insulation voltage of terminal block - operating voltage : according to fuse.

Fuse holder terminal blocks

5x20 mm .197x.787 in. and 5x25 mm .197x.984 in.

Screw clamp,  DIN 1 - DIN3

M 4/8.SF- 4 mm² blocks - 8 mm .315" spacing

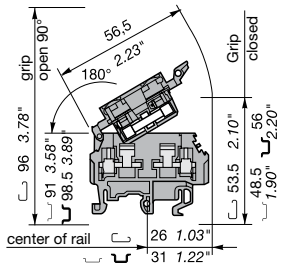

M 4/8.SF

Characteristics		IEC		UL	CSA
		NFC	DIN		
Wire size	Solid	0.5 - 6 mm ²		22-12 AWG	22-12 AWG
mm ² / AWG	Stranded	0.5 - 4 mm ²			
Voltage	V	630 ⊕		600 ⊕	250
Current	A	6.3		10	10
Rated wire size	mm ² / AWG	4 mm ²		12 AWG	12 AWG
Wire stripping length	mm / inches	9.5 mm / .37"			
Recommended torque	Nm / lb.in	0.5-0.8 Nm / 4.4-7.1 lb.in			

Selection

Description	Type	Packaging	Catalog number	
Standard block	grey	M 4/8.SF	50	011565725
Block with test socket Ø2 mm	grey	M 4/8.SF	50	011566222
Standard block	orange	M 4/8.SF2	50	010513511
Standard block	beige	M 4/8.SF	50	019565726

M 4/8.SFL - 4 mm² blocks - 8 mm .315" spacing

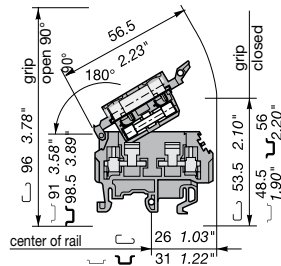

M 4/8.SFL

Characteristics		IEC		UL	CSA
		NFC	DIN		
Wire size	Solid	0.5 - 6 mm ²		22-12 AWG	22-12 AWG
mm ² / AWG	Stranded	0.5 - 4 mm ²			
Voltage	V	400		600	250
Current	A	6.3		10	10
Rated wire size	mm ² / AWG	4 mm ²		12 AWG	12 AWG
Wire stripping length	mm / inches	9.5 mm / .37"			
Recommended torque	Nm / lb.in	0.5-0.8 Nm / 4.4-7.1 lb.in			

Selection

Description	Type	Packaging	Catalog number	
Block w/ fusion indicator 110-230V neon	grey	M 4/8.SFL	50	011566121
Block with fusion indicator 24V LED	grey	M 4/8.SFD	50	011566323

M 4/8.SN - 4 mm² blocks - 8 mm .315" spacing

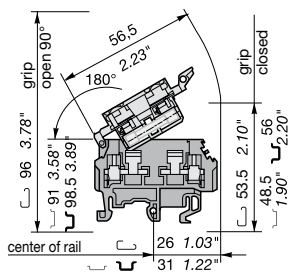

M 4/8.SN

Characteristics		IEC		UL	CSA
		NFC	DIN		
Wire size	Solid	0.5 - 6 mm ²		22-12 AWG	24-12 AWG
mm ² / AWG	Stranded	0.5 - 4 mm ²			
Voltage	V	630 ⊕		600	250
Current	A	6.3		10	10
Rated wire size	mm ² / AWG	4 mm ²		12 AWG	12 AWG
Wire stripping length	mm / inches	9.5 mm / .37"			
Recommended torque	Nm / lb.in	0.5-0.8 Nm / 4.4-7.1 lb.in			

Selection

Description	Type	Packaging	Catalog number
Standard block grey body/blue grip	M 4/8.SN	50	011565907

Accessories

Description	Type	Packaging	Catalog number		
End stop	BAM2	9.9 mm	50	020635116	
End section	grey	FEM8S	1.5 mm	20	011695115
	orange	FEM8S	1.5 mm	20	010392315

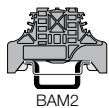

⊕ Insulation voltage of terminal block - operating voltage : according to fuse.
 ⊕ 400 V for block M 4/6.SFT

Fuse holder terminal blocks

Double deck for 5x20 and 5 x 25mm fuses

Screw clamp, DIN 1 - DIN3

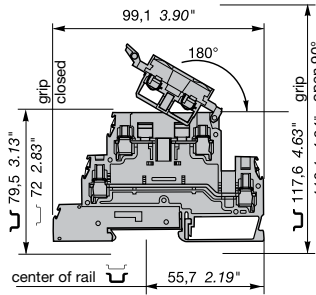

D 4/8.D2.P.SF

Characteristics		IEC		UL	CSA
		NFC	DIN		
Wire size mm ² / AWG	Comp. clamp feed through	Solid	0.5 - 6 mm ²	20-10 AWG	20-10 AWG
		Stranded	0.5 - 4 mm ²	20-12 AWG	20-12 AWG
Voltage	Comp. clamp ground	Solid	0.2 - 4 mm ²	20-10 AWG	20-10 AWG
		Stranded	0.22 - 4 mm ²	20-12 AWG	20-12 AWG
Current		V	300 Ⓞ	300 Ⓞ	300 Ⓞ
Rated wire size		A	6.3	6.3	6.3
Wire stripping length		mm ² / AWG	4 mm ²	12 AWG	12 AWG
Recommended torque		mm / inches	9,5 mm / .37"		
		Nm / lb.in	0.5-0.8 Nm / 4.4-7.1 lb.in		

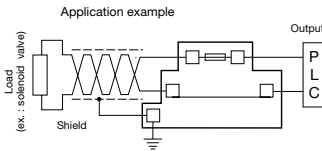

Selection

Description	Type	Packaging	Catalog number
Grey	D 4/8.D2.P.SF	25	040027020
Grey Neon 110-230 V	D 4/8.D2.P.SFL	25	040027115
Grey LED 24 V	D 4/8.D2.P.SFD	25	040027216

Accessories

Description	Type	Packaging	Catalog number
1 End section grey V0	FEM8D2S 1.5 mm	20	040027317
2 Test socket	AL2 Ⓞ DIA. 2mm	50	016304321
	AL3 Ⓞ DIA. 3mm	50	016326100
	AL4 Ⓞ DIA. 4mm	50	016326201
3 Test plug	FC2 DIA. 2mm	100	000786526
	FC4 DIA. 4mm	10	016786001
4 Assembled jumper bar (without IP20 protection)	2 poles BJM8 Ⓞ 41 A	10	016852005
	3 poles BJM8 Ⓞ 41 A	10	016852122
	4 poles BJM8 Ⓞ 41 A	10	016852223
	5 poles BJM8 Ⓞ 41 A	10	016852324
	10 poles BJM8 Ⓞ 41 A	10	016897400
5 Connector plate	EL6 35 A	10	017352721
6 Comb-type jumper bar 10 poles	PC81 35 A	10	017352311
7 IDC jumper	AD2,5 24 A	50	011420520
8 Assembly rod	2 poles TGA8	10	016867211
	3 poles TGA8	10	016867312
	4 poles TGA8	10	016867413
9 Assembly ring	ANT	10	016867514
10 Fuse 5 x 20	250 V FU520 0,5 A	10	000828815
	250 V FU520 1 A	10	000829013
	250 V FU520 2 A	10	000829100
	250 V FU520 3,15 A	10	000828916
	250 V FU520 5 A	10	000829201
	Fuse 5 x 25	250 V FU525 1,6 A	10
Fast acting HPC 1500 A	250 V FU525 2 A	10	016754723
	250 V FU525 2,5 A	10	016754804
	250 V FU525 4 A	10	016754905
	250 V FU525 6,3 A	10	016755002
	11 Disconnect link bar	CN5	10

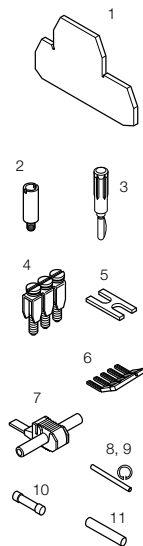

① Insulation voltage of terminal block - operating voltage : according to fuse.
 Ⓞ Only for lower deck.

Fuse holder terminal blocks & heavy duty switch

Terminal block with contact control pull lever

Screw clamp, C U DIN 1-3

ML 10/13.SF - for fuses 6.35x25.4 mm 1/4x1 in. and 6.35x32 mm 1/4x1 1/4 in. - 10 mm² blocks - 13 mm .512" spacing

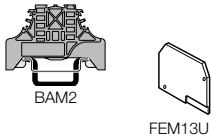
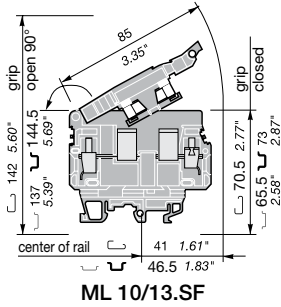

Characteristics		IEC		UL	CSA
		NFC	DIN		
Wire size	Solid	0.5 - 16 mm ²		22-10 AWG	22-8 AWG
mm ² / AWG	Stranded	0.5 - 10 mm ²			
Voltage	V	800 0		600	600
Current	A	16		25	25
Rated wire size	mm ² / AWG	10 mm ²		10 AWG	8 AWG
Wire stripping length	mm / inches	12 mm / .472"			
Recommended torque	Nm / lb.in	1.2-1.4 Nm / 10.6-12.3 lb.in			

Selection

Description	Type	Packaging	Catalog number	
Standard block (no indicator)	black	ML 10/13.SF	20	019909513
Block with fusion indicator (Neon, 110 - 230 V)			20	019916800

Other voltages available. Contact ABB.

Accessories

Description	Type	Packaging	Catalog number		
End stop	BAM2	9.9 mm	50	020635116	
End section	black	FEM13U	1.5 mm	10	019963524

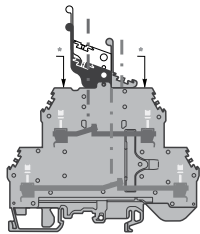
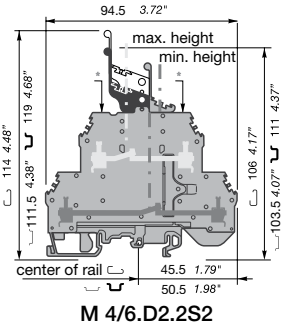

M 4/6.D2.2S2.T

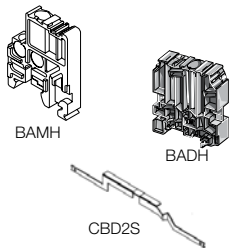

M 4/6.D2.2S2... - 4 mm² blocks - 6 mm .238" spacing

Characteristics		IEC		UL	CSA
		NFC	DIN		
Wire size	Solid	0.2 - 4 mm ²		24-10 AWG	24-10 AWG
mm ² / AWG	Stranded	0.2 - 4 mm ²			
Voltage	V	500		300	300
Current	A	10		10	10
Rated wire size	mm ² / AWG	4 mm ²		10 AWG	10 AWG
Wire stripping length	mm / inches	9.5 mm / .374"			
Recommended torque	Nm / lb.in	0.5-0.8 Nm / 4.4-7.1 lb.in			

Selection

Description	Type	Packaging	Catalog number
Standard block grey	M 4/6.D2.2S2	25	019944425
Block grey with 4 tests DIA. 2 mm)	M 4/6.D2.2S2.T	25	019944801

Accessories

Description	Type	Packaging	Catalog number	
End stop	BADH	12 mm	50	011690027
	BAMH	9.1 mm	50	011483600
Shield connector	CBD2S		50	017840814

Fuse holder terminal blocks

For 10x38mm and Class CC fuse
Screw clamp,  DIN 1-3



1SNA400728R1700

The new range of modular fuse holders provides:



- Safe operation,
- Fast and simple multiple pole assembly
- Quick fuse installation and replacement
- Blown fuse indicator for quick identification of fuse failures.

The Class CC fuse versions are rejection style with high breaking capacity (200 KA).

Modular fuse holders provide a wide fuse contact surface and have electrolytic silver plated copper contacts to ensure minimal contact resistance and reliable operation. The insulation material is UL94 V0.

Technical specifications

Wire size range	8-18 AWG
Class CC fuses	
Rated current	30 A
Rated voltage	600 V
10x38 fuses	
Rated current	32 A
Rated voltage	690 V
Blown fuse indicator	120-690 VAC

Designation	Catalog numbers	Description
For Class CC fuses		
DL16/17,5.SF.CC1	1SNA400728R1700	1 pole
DL16/17,5.SF.CC2	1SNA400729R1000	2 poles 
DL16/17,5.SF.CC3	1SNA400730R1500	3 poles
DL16/17,5.SFL.CC1	1SNA400731R0200	1 pole with blown fuse indicator
DL16/17,5.SFL.CC2	1SNA400747R1200	2 poles with blown fuse indicator
DL16/17,5.SFL.CC3	1SNA400748R2300	3 poles with blown fuse indicator
For 10x38 fuses ①		
DL16/17,5.SF	1SNA400732R0300	1 pole 
DL16/17,5.SF2	1SNA400739R1200	2 poles
DL16/17,5.SF3	1SNA400741R1400	3 poles
DL16/17,5.SN	1SNA400734R0500	Neutral pole
DL16/17,5.SFL	1SNA400733R0400	1 pole with blown fuse indicator
DL16/17,5.SFL2	XUST03370	2 poles with blown fuse indicator
DL16/17,5.SFL3	XUST03371	3 poles with blown fuse indicator
Accessories		
VRDL	1SNA400735R0600	Assembly clip
TGDL	1SNA400736R0700	Assembly rod

① This item will replace our current DL 10/17 (1SNA116438R1300 and 1SNA116439R1400)

Feed through and ground terminal blocks

Spring clamp, U DIN 3

D 2,5/5...L - 2.5 mm² blocks - 5 mm .198" spacing

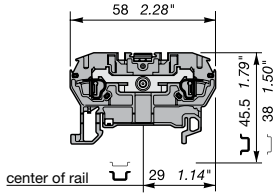

D 2,5/5.2L

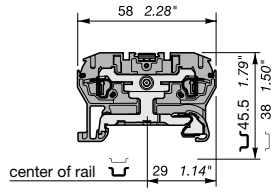

D 2,5/5.P.2L

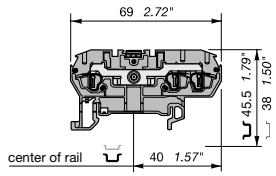

D 2,5/5.3L

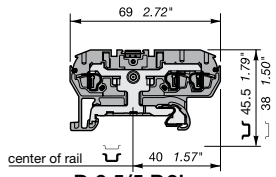

D 2,5/5.P.3L

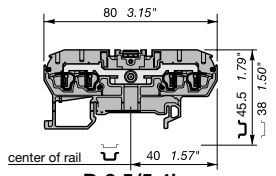

D 2,5/5.4L

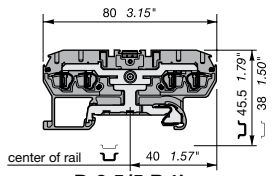

D 2,5/5.P.4L

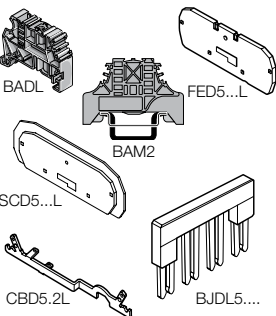

Characteristics		IEC		UL	CSA
		NFC	DIN		
Wire size mm ² / AWG	Solid	0.12 - 4 mm ²		26-12 AWG	26-12 AWG
	Stranded	0.12 - 2.5 mm ²			
	Isolated ferrules	0.5 - 2.5 mm ²			
Voltage	V	600		600	600
Current	A	24		15	15
Short circuit current (D 2,5/5.Pl...L)	A / s	300 A/1s			
Short circuit current (D 2,5/5.P...L)	A / s	300 A/1s			
Rated wire size	mm ² / AWG	2.5 mm ²		12 AWG	12 AWG
Wire stripping length	mm / inches			9.5 mm / .37"	

D 2,5/5.2L Selection

Description	Type	Packaging	Catalog number
Standard block grey	D 2,5/5.2L	50	029002127
Standard block blue	D 2,5/5.N.2L	50	029002321
Standard block yellow	D 2,5/5.2L	50	029002725
Standard block orange	D 2,5/5.2L	50	029002220
Standard block red	D 2,5/5.2L	50	029002422
Standard block black	D 2,5/5.2L	50	029002624
Standard block green	D 2,5/5.2L	50	029002806
Standard block white	D 2,5/5.2L	50	029002523
Standard block brown	D 2,5/5.2L	50	029046400
Standard block violet	D 2,5/5.2L	50	029046501
Ground block green/yellow	D 2,5/5.P.2L ①	50	029002907

D 2,5/5.3L Selection

Standard block grey	D 2,5/5.3L	50	029003121
Standard block blue	D 2,5/5.N.3L	50	029003323
Standard block orange	D 2,5/5.3L	50	029003222
Standard block red	D 2,5/5.3L	50	029003424
Standard block black	D 2,5/5.3L	50	029003626
Standard block brown	D 2,5/5.3L	50	1SNS43000Z1081
Standard block white	D 2,5/5.3L	50	029003525
Standard block yellow	D 2,5/5.3L	50	029003727
Ground block green/yellow	D 2,5/5.P.3L ①	50	029003901

D 2,5/5.4L Selection

Standard block grey	D 2,5/5.4L	50	029001125
Standard block blue	D 2,5/5.N.4L	50	029001327
Standard block orange	D 2,5/5.4L	50	029001226
Ground block green/yellow	D 2,5/5.P.4L ①	50	029001905

Accessories

Description	Type	Packaging	Catalog number	
End stop (light grey)	(screwless)	BADL 9 mm	50	039990302
	(with screw)	BAM2 9.9 mm	50	039996701
End section	grey	FED5.2L 2.5 mm ②	20	029106124
	orange	FED5.2L 2.5 mm ②	20	029106225
	grey	FED5.3L 2.5 mm ③	20	029105122
	orange	FED5.3L 2.5 mm ③	20	029105223
	grey	FED5.4L 2.5 mm ④	20	029104120
	orange	FED5.4L 2.5 mm ④	20	029104221
Separator	orange	SCD5.2L 2.5 mm ②	20	029135204
	grey	SCD5.2L 2.5 mm ③	20	029135103
	orange	SCD5.3L 2.5 mm ③	20	029136206
	orange	SCD5.4L 2.5 mm ④	20	029137200
	Jumper bar, IP20	2 poles	BJDL5.2 24 A	50
	3 poles	BJDL5.3 24 A	50	029110324
	4 poles	BJDL5.4 24 A	50	029110425
	5 poles	BJDL5.5 24 A	20	029110526
	10 poles	BJDL5.10 24 A	20	029111026
Shield connector		CBD5.2L 0.5 mm ④	50	029107724

① With rail contact.
 ② Only for D 2,5/5...2L
 ③ Only for D 2,5/5...3L
 ④ Only for D 2,5/5...4L

Feed through and ground terminal blocks

Spring clamp, DIN 3

D 4/6...L - 4 mm² blocks - 6 mm .238" spacing

Characteristics

		IEC		UL	CSA
		NFC	DIN		
Wire size mm ² / AWG	Solid	0.2 - 6 mm ²		24-10 AWG	24-10 AWG
	Stranded	0.2 - 4 mm ²			
	Isolated ferrules	0.5 - 4 mm ²			
Voltage	V	800		600	600
Current	A	32		25	25
Short circuit current (D 4/6.Pl...L)	A / s	480 A/1s			
Short circuit current (D 4/6.P...L)	A / s	480 A/1s			
Rated wire size	mm ² / AWG	4 mm ²		10 AWG	10 AWG
Wire stripping length	mm / inches			11 mm / .43"	

D 4/6.2L Selection

Description	Type	Packaging	Catalog number
Standard block grey	D 4/6.2L	50	029006107
Standard block blue	D 4/6.N.2L	50	029006301
Standard block orange	D 4/6.2L	50	029006200
Standard block black	D 4/6.2L	50	029006604
Standard block red	D 4/6.2L	50	029006402
Standard block yellow	D 4/6.2L	50	029006705
Standard block white	D 4/6.2L	50	1SNS430000Z0911
Standard block brown	D 4/6.2L	50	1SNS430000Z0912
Ground block green/yellow	D 4/6.P.2L ①	50	029006917

D 4/6.3L Selection

Description	Type	Packaging	Catalog number
Standard block grey	D 4/6.3L	50	029040506
Standard block blue	D 4/6.N.3L	50	029040700
Standard block orange	D 4/6.3L	50	029040607
Ground block green/yellow	D 4/6.P.3L ①	50	029040912

D 4/6.4L Selection

Description	Type	Packaging	Catalog number
Standard block grey	D 4/6.4L	50	029041006
Standard block blue	D 4/6.N.4	50	029041224
Standard block orange	D 4/6.4L	50	029041123
Ground block green/yellow	D 4/6.P.4L ①	50	029041426

Accessories

Description	Type	Packaging	Catalog number	
End stop (light grey)	(screwless)	BADL 9 mm	50	039990302
	(with screw)	BAM2 9.9 mm	50	039996701
End section	grey	FED5.2L 2.5 mm ②	20	029106124
	orange	FED5.2L 2.5 mm ②	20	029106225
	grey	FED6.3L 2.5 mm ③	20	029169424
	orange	FED6.3L 2.5 mm ③	20	029169525
	grey	FED6.4L 2.5 mm ④	20	029169626
	orange	FED6.4L 2.5 mm ④	20	029169727
Separator	orange	SCD5.2L 2.5 mm ②	20	029135204
	grey	SCD5.2L 2.5 mm ②	20	029135103
Jumper bar, IP20	2 poles	BJDL6.2 32 A	50	029112824
	3 poles	BJDL6.3 32 A	50	029112925
	4 poles	BJDL6.4 32 A	50	029119417
	5 poles	BJDL6.5 32 A	20	029119510

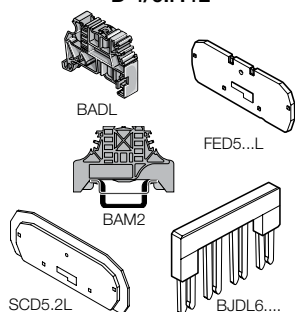
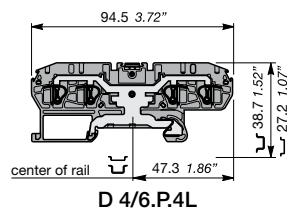
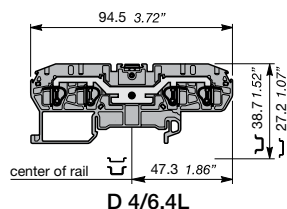
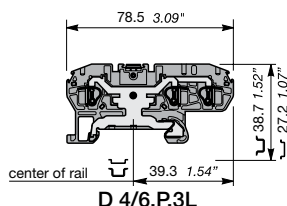
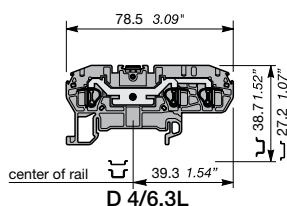
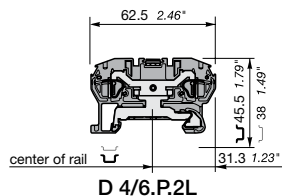
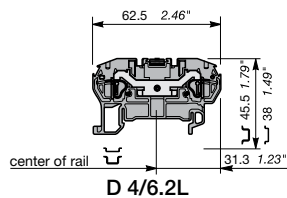

① With rail contact.
 ② Only for D 4/6...2L
 ③ Only for D 4/6...3L
 ④ Only for D 4/6...4L

Feed through and ground terminal blocks

Spring clamp, U DIN 3

D 6/8.2L - 6 mm² blocks - 8 mm .315" spacing

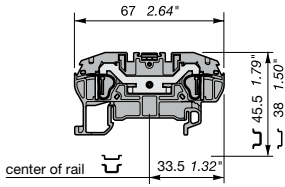

D 6/8.2L

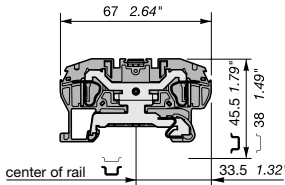

D 6/8.P.2L

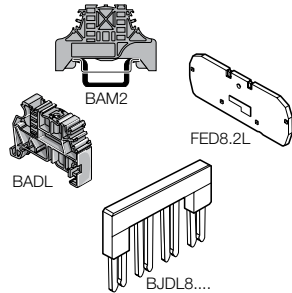

Characteristics		IEC		UL	CSA
		NFC	DIN		
Wire size mm ² / AWG	Solid	0.5 - 10 mm ²		22-8 AWG	22-8 AWG
	Stranded	0.5 - 6 mm ²			
	Isolated ferrules	0.5 - 6 mm ²			
Voltage	V	800		600	600
Current	A	41		40	40
Short circuit current (D6/8.PI.2L)	A / s	720 A/1s			
Short circuit current (D6/8.P.2L)	A / s	720 A/1s			
Rated wire size	mm ² / AWG	6 mm ²		8 AWG	8 AWG
Wire stripping length	mm / inches	12.5 mm / .49"			

Selection

Description	Type	Packaging	Catalog number
Standard block grey	D 6/8.2L	50	029008124
Standard block blue	D 6/8.N.2L	50	029008326
Standard block orange	D 6/8.2L	50	029008225
Standard block black	D 6/8.2L	50	029008621
Standard block red	D 6/8.2L	50	029008427
Standard block yellow	D 6/8.2L	50	029008722
Ground block green/yellow	D 6/8.P.2L ⊕	50	029008904

Accessories

Description	Type	Packaging	Catalog number	
End stop (light grey)	(screwless)	BADL 9 mm	50	039990302
	(with screw)	BAM2 9.9 mm	50	039996701
End section	grey	FED8.2L 2.5 mm	20	029116125
	orange	FED8.2L 2.5 mm	20	029116226
Assembled jumper bar (with IP20 protection)	2 poles	BJDL8.2 41 A ⊕	50	029112216
	3 poles	BJDL8.3 41 A ⊕	50	029112317
	4 poles	BJDL8.4 41 A ⊕	50	029114424
	5 poles	BJDL8.5 41 A ⊕	20	029114525

D 10/10.2L - 10 mm² blocks - 10 mm .394" spacing

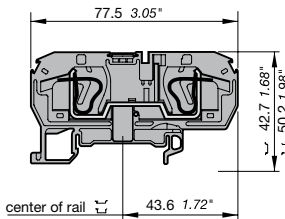

D 10/10.2L

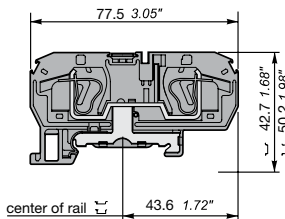

D 10/10.P.2L

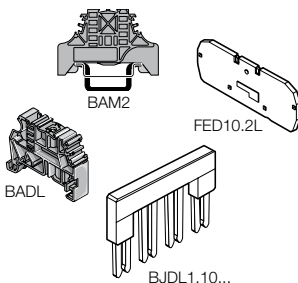

Characteristics		IEC		UL	CSA
		NFC	DIN		
Wire size mm ² / AWG	Solid	0.5 - 16 mm ²		20-6 AWG	20-6 AWG
	Stranded	0.5 - 10 mm ²			
	Isolated ferrules	0.5 - 10 mm ²			
Voltage	V	1000		600	600
Current	A	57		50	50
Short circuit current (D 10/10.PI.2L)	A / s	1200 A/1s			
Short circuit current (D 10/10.P.2L)	A / s	1200 A/1s			
Rated wire size	mm ² / AWG	10 mm ²		6 AWG	6 AWG
Wire stripping length	mm / inches	12 mm / .47"			

Selection

Description	Type	Packaging	Catalog number
Standard block grey	D 10/10.2L	50	029029103
Standard block blue	D 10/10.N.2L	50	029029305
Standard block orange	D 10/10.2L	50	029029204
Standard block black	D 10/10.2L	50	029029600
Standard block red	D 10/10.2L	50	029029406
Standard block yellow	D 10/10.2L	50	029029701
Ground block green/yellow	D 10/10.P.2L ⊕	50	029029913

Accessories

Description	Type	Packaging	Catalog number	
End stop (light grey)	(screwless)	BADL 9 mm	50	039990302
	(with screw)	BAM2 9.9 mm	50	039996701
End section	grey	FED10.2L 2.5 mm	20	029146122
	orange	FED10.2L 2.5 mm	20	029146223
Assembled jumper bar (with IP20 protection)	2 poles	BJDL1.10.2 57 A ⊕	50	029147225
	3 poles	BJDL1.10.3 57 A ⊕	50	029147427
	4 poles	BJDL1.10.4 57 A ⊕	50	029147621
	5 poles	BJDL1.10.5 57 A ⊕	50	029147803

⊕ With rail contact.
⊗ Except for D 6/8.P.2L
⊙ Except for D 10/10.P.2L

Feed through terminal blocks - 3 level

Spring clamp, DIN 3

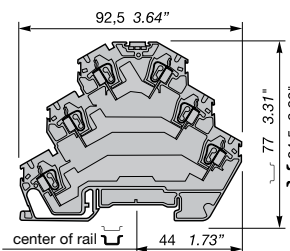

D 2,5/5.T3.L

D 2,5/5.T3.L

Characteristics		IEC		UL	CSA
		NFC	DIN		
Wire size	Solid	0.14 - 4 mm ²	24-12 AWG	24-12 AWG	
mm ² / AWG	Stranded	0.14 - 2.5 mm ²	24-14 AWG	24-14 AWG	
Voltage	V	500	150	150	
Current	A	20	16	16	
Rated wire size	mm ² / AWG	2.5 mm ²	12	12	
Wire stripping length	mm / inches	9.5 mm / .37"			

Selection

Description	Type	Packaging	Catalog number
Grey	D 2,5/5.T3.L	25	1SNA290456R0000

Accessories

Description	Type	Packaging	Catalog number
1 End section	grey FED5.T3.L V0 th. 2.5 mm	20	1SNA291817R1700
2 Test plug	black FC2.MC \odot V2 DIA 2.0 mm	10	1SNA107239R0300
3 Assembled jumper bar (IP 20-24 A)	orange BJD5.2 V0 2 poles	50	029110223
	BJDL5.3 V0 3 poles	50	029110324
	BJDL5.4 V0 4 poles	50	029110425
	BJDL5.5 V0 5 poles	20	029110526
	BJDL5.6 V0 6 poles	20	029110627
	BJDL5.7 V0 7 poles	20	029110720
	BJDL5.8 V0 8 poles	20	029110801
	BJDL5.9 V0 9 poles	20	029110902
	BJDL5.10 V0 10 poles	20	029111026

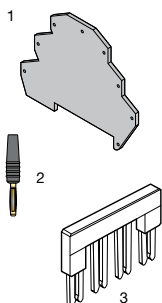

D 2,5/5.T1.L

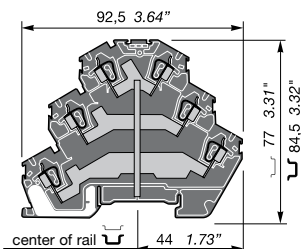

D 2,5/5.T1.L

Characteristics		IEC		UL	CSA
		NFC	DIN		
Wire size	Solid	0.14 - 4 mm ²	24-12 AWG	24-12 AWG	
mm ² / AWG	Stranded	0.14 - 2.5 mm ²	24-14 AWG	24-14 AWG	
Voltage	V	500	150	150	
Current	A	24	20	20	
Rated wire size	mm ² / AWG	2.5 mm ²	12	12	
Wire stripping length	mm / inches	9.5 mm / .37"			

Selection

Description	Type	Packaging	Catalog number
Grey	D 2,5/5.T1.L	25	1SNA290457R0100

Accessories

Description	Type	Packaging	Catalog number
1 End section	grey FED5.T3.L V0 th. 2.5 mm	20	1SNA291817R1700
2 Test plug	black FC2.MC \odot V2 DIA 2.0 mm	10	1SNA107239R0300
3 Jumper bar (IP 20-24 A)	orange BJD5.2 V0 2 poles	50	029110223
	BJDL5.3 V0 3 poles	50	029110324
	BJDL5.4 V0 4 poles	50	029110425
	BJDL5.5 V0 5 poles	20	029110526
	BJDL5.6 V0 6 poles	20	029110627
	BJDL5.7 V0 7 poles	20	029110720
	BJDL5.8 V0 8 poles	20	029110801
	BJDL5.9 V0 9 poles	20	029110902
	BJDL5.10 V0 10 poles	20	029111026

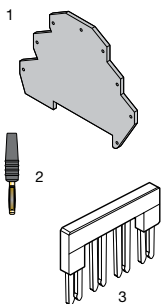

\odot The use of the test plug decreases the block's voltage rating; U = 200 V.

Feed through and ground terminal blocks - 4 level Spring clamp, U DIN 3

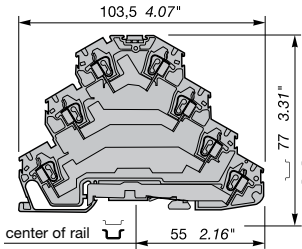

D 2,5/5.T3.PL

D 2,5/5.T3.PL

Characteristics

		IEC		UL	CSA
		NFC	DIN		
Wire size	Solid	0.14 - 4 mm ²		24-12 AWG	24-12 AWG
mm ² / AWG	Stranded	0.14 - 2.5 mm ²		24-14 AWG	24-14 AWG
Voltage	V	500		150	150
Current	A	20		16	16
Rated wire size	mm ² / AWG	2.5 mm ²		12	12
Wire stripping length	mm / inches	9.5 mm / .37"			

Selection

Description	Type	Packaging	Catalog number
Grey	D 2,5/5.T3.PL	25	1SNA290458R1200

Accessories

Description	Type	Packaging	Catalog number
1 End section grey	FED5.T3.L V0 th. 2.5 mm	20	1SNA291818R2000
2 Test plug black	FC2.MC ① V2 DIA 2.0 mm	10	1SNA107239R0300
3 Assembled jumper bar orange (IP 20-24 A)	BJDL5.2 V0 2 poles	50	029110223
	BJDL5.3 V0 3 poles	50	029110324
	BJDL5.4 V0 4 poles	50	029110425
	BJDL5.5 V0 5 poles	20	029110526
	BJDL5.6 V0 6 poles	20	029110627
	BJDL5.7 V0 7 poles	20	029110720
	BJDL5.8 V0 8 poles	20	029110801
	BJDL5.9 V0 9 poles	20	029110902
	BJDL5.10 V0 10 poles	20	029111026

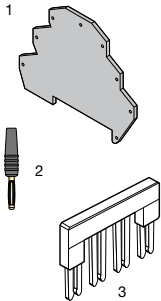

10

D 2,5/5.T1.PL

Characteristics

		IEC		UL	CSA
		NFC	DIN		
Wire size	Solid	0.14 - 4 mm ²		24-12 AWG	24-12 AWG
mm ² / AWG	Stranded	0.14 - 2.5 mm ²		24-14 AWG	24-14 AWG
Voltage	V	500		N/A	N/A
Current	A	300		N/A	N/A
Rated wire size	mm ² / AWG	2.5 mm ²		12	12
Wire stripping length	mm / inches	9.5 mm / .37"			

Selection

Description	Type	Packaging	Catalog number
Grey	D 2,5/5.T1.PL	25	1SNA290459R1300

Accessories

Description	Type	Packaging	Catalog number
1 End section grey	FED5.T3.L V0 th. 2.5 mm	20	1SNA291818R2000
2 Test plug black	FC2.MC ① V2 DIA 2.0 mm	10	1SNA107239R0300
3 Jumper bar orange (IP 20-24 A)	BJDL5.2 V0 2 poles	50	029110223
	BJDL5.3 V0 3 poles	50	029110324
	BJDL5.4 V0 4 poles	50	029110425
	BJDL5.5 V0 5 poles	20	029110526
	BJDL5.6 V0 6 poles	20	029110627
	BJDL5.7 V0 7 poles	20	029110720
	BJDL5.8 V0 8 poles	20	029110801
	BJDL5.9 V0 9 poles	20	029110902
	BJDL5.10 V0 10 poles	20	029111026

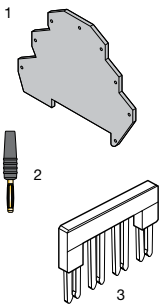

① The use of the test plug decreases the block's voltage rating: U = 200 V.

Fuse holder terminal blocks

5x20 mm .197x.787 in. and 5x25 mm .197x.984 in.
Spring clamp,  DIN 3

D 2,5/8.SFT.2L - 2.5 mm² blocks - 8 mm .315" spacing

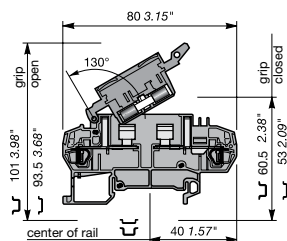

D 2,5/8.SFT.2L

Characteristics		IEC		UL	CSA
		NFC	DIN		
Wire size mm ² / AWG	Solid	0.12 - 4 mm ²		26-12 AWG	26-12 AWG
	Stranded	0.12 - 2.5 mm ²			
	Isolated ferrules	0.5 - 2.5 mm ²			
Voltage	V	630	600	600	600
Current	A	6.3	8	8	8
Rated wire size	mm ² / AWG	2.5 mm ²	12 AWG	12 AWG	12 AWG
Wire stripping length	mm / inches	9.5 mm / .37"			

Selection

Description	Type	Packaging	Catalog number
Standard block grey	D 2,5/8.SFT.2L	50	029009126
Standard block orange	D 2,5/8.SFT.2L	50	029009227

Accessories

Description	Type	Packaging	Catalog number	
End stop (light grey)	(screwless)	BADL 9 mm	50	039990302
	(with screw)	BAM2 9.9 mm	50	039996701
End section	grey	FED8SF.2L 3 mm	20	029113117
	orange	FED8SF.2L 3 mm	20	029113210
Assembled jumper bar (with IP20 protection)	2 poles	BJDL8.2 24 A	50	029112216
	3 poles	BJDL8.3 24 A	50	029112317
	4 poles	BJDL8.4 24 A	50	029114424
	5 poles	BJDL8.5 24 A	20	029114525

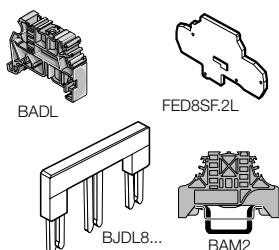

D 2,5/8.S...T.2L - 2.5 mm² blocks - 8 mm .315" spacing

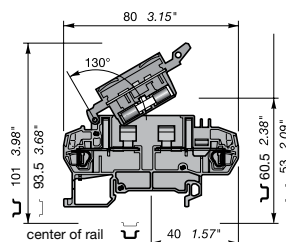

D 2,5/8.S...T.2L

Characteristics		IEC		UL	CSA
		NFC	DIN		
Wire size mm ² / AWG	Solid	0.12 - 4 mm ²		26-12 AWG	26-12 AWG
	Stranded	0.12 - 2.5 mm ²			
	Isolated ferrules	0.5 - 2.5 mm ²			
Voltage	V	630	600	600	600
Current	A	6.3	8	8	8
Rated wire size	mm ² / AWG	2.5 mm ²	12 AWG	12 AWG	12 AWG
Wire stripping length	mm / inches	9.5 mm / .37"			

Selection

Description	Type	Packaging	Catalog number
Block with test socket ①	D 2,5/8.SFLT.2L	50	029009320
Block with test socket ②	D 2,5/8.SFDT.2L	50	029009421
Block with test socket ③	D 2,5/8.SFD1T.2L	50	029009522
Block with test socket, grey body/blue lever	D 2,5/8.SNT.2L	50	029009724

Accessories

Description	Type	Packaging	Catalog number	
End stop	(screwless)	BADL 9 mm	50	039990302
	(with screw)	BAM2 9.9 mm	50	039996701
End section	grey	FED8SF.2L 3 mm	20	029113117
	orange	FED8SF.2L 3 mm	20	029113210
Assembled jumper bar (with IP20 protection)	2 poles	BJDL8.2 24 A	50	029112216
	3 poles	BJDL8.3 24 A	50	029112317
	4 poles	BJDL8.4 24 A	50	029114424
	5 poles	BJDL8.5 24 A	20	029114525

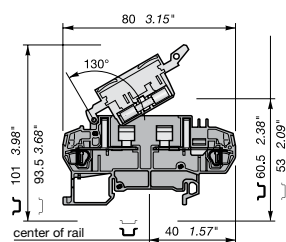

D 2,5/8.SNT.2L

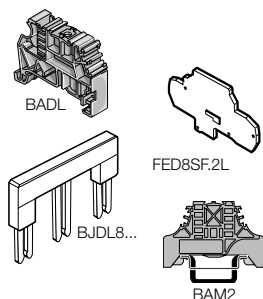

① Blown fuse indicator with neon lamp 110 V - 220 V
② Blown fuse indicator with LED 24 V
③ Blown fuse indicator with LED 48 V

Feed through and ground terminal blocks

Insulation displacement

ADO - Screw clamp, U DIN 3

D 2,5/5.ADO - 1 mm² blocks - 5 mm .198" spacing

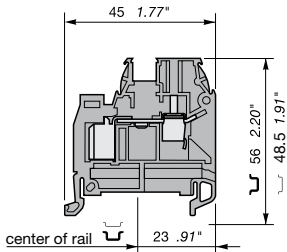

D 2,5/5.ADO

Characteristics		IEC		UL	CSA
		NFC	DIN		
Wire size mm ² / AWG	Screw	Solid	0.2 - 4 mm ²	22-12 AWG	22-12 AWG
		Stranded	0.22 - 2.5 mm ²		
Wire size mm ² / AWG	ADO	Solid	0.2 - 1 mm ²	24-18 AWG	24-18 AWG
		Stranded	0.22 - 1 mm ²		
Voltage		V	1000	600	600
Current		A	13.5	7	7
Short circuit current (D2,5/5PI.ADO)		A / s	120 A/1s		
Rated wire size		mm ² / AWG	1 mm ²	18 AWG	18 AWG
Wire stripping length (screw)		mm / inches		9.5 mm / .37"	
Recommended torque (screw)		Nm / lb.in	0.4-0.6 / 3.5-5.3 lb.in		

2 wires of the same gauge and nature per ADO connection

Selection

Description	Type	Packaging	Catalog number
Standard block grey	D 2,5/5.ADO	50	019955423
Standard block orange	D 2,5/5.ADO	50	019955524
Standard block blue	D 2,5/5.N.ADO	50	019955625
Standard block black	D 2,5/5.ADO	50	019955726
Standard block red	D 2,5/5.ADO	50	019955807
Standard block yellow	D 2,5/5.ADO	50	019956005
Standard block ivory	D 2,5/5.ADO	50	019955900
Standard block green	D 2,5/5.ADO	50	019956122

Accessories

Description	Type	Packaging	Catalog number	
End stop (light grey)	(screwless)	BADL 9 mm	50	039990302
	(with screw)	BAM2 9.9 mm	50	039996701
End section	grey	FEDAD1 3 mm	20	019933620
	blue	FEDAD1 3 mm	20	019933802
	yellow	FEDAD1 3 mm	20	019933903
Assembled jumper bar (with IP20 protection)	2 poles	BJMI5 24 A	10	017627816
	3 poles	BJMI5 24 A	10	017627917
	4 poles	BJMI5 24 A	10	017628005
	5 poles	BJMI5 24 A	10	017628122
	10 poles	BJMI5 24 A	10	017628223
Shield connector		CBM5 0.5 mm	50	017874514
		CBM8 0.8 mm	50	017874615

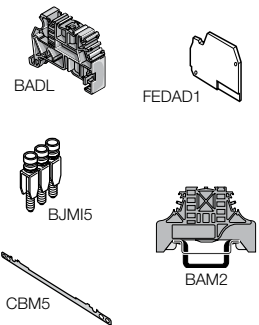

D 2,5/5.PADO - 1 mm² ground block with rail contact - 5 mm .198" spacing

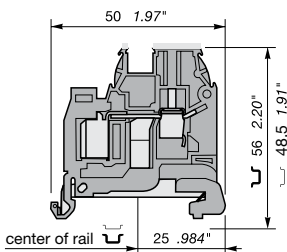

D 2,5/5.PADO

Characteristics		IEC		UL	CSA
		NFC	DIN		
Wire size mm ² / AWG	Screw	Solid	0.2 - 4 mm ²	22-12 AWG	22-12 AWG
		Stranded	0.22 - 2.5 mm ²		
Wire size mm ² / AWG	ADO	Solid	0.2 - 1 mm ²	24-18 AWG	24-18 AWG
		Stranded	0.22 - 1 mm ²		
Short circuit current		A / s	120 A/1s		
Rated wire size		mm ² / AWG	1 mm ²	18 AWG	18 AWG
Wire stripping length (screw)		mm / inches		9.5 mm / .37"	
Recommended torque (screw)		Nm / lb.in	0.4-0.6 / 3.5-5.3 lb.in		

2 wires of the same gauge and nature per ADO connection

Selection

Description	Type	Packaging	Catalog number
Ground block green/yellow	D 2,5/5.PADO	50	039903005

Accessories

Description	Type	Packaging	Catalog number	
End section	grey	FEDAD1 3 mm	20	019933620
	yellow	FEDAD1 3 mm	20	019933903



FEDAD1

Feed through and ground terminal blocks

Insulation displacement

ADO - Screw clamp, DIN 3

D 4/6... .ADO - 1.5 mm² blocks - 6 mm .238" spacing

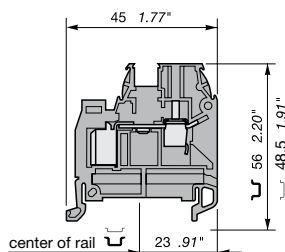

D 4/6... .ADO

Characteristics		IEC		UL	CSA
		NFC	DIN		
Wire size mm ² / AWG	Screw	Solid	0.2- 4 mm ²	22-10 AWG	22-10 AWG
		Stranded	0.22 - 4 mm ²		
Voltage	ADO	Solid	0.34 - 1.5 mm ²	22-16 AWG	22-16 AWG
		Stranded	0.34 - 1.5 mm ²		
Current		V	1000	600	600
Short circuit current (D4/6.PI.ADO)		A	17.5	18	18
Rated wire size		A / s	180 A/1s		
Wire stripping length (screw)		mm ² / AWG	1.5 mm ²	16 AWG	16 AWG
Recommended torque (screw)		mm / inches		9.5 mm / .37"	
		Nm / lb.in	0.5-0.8 / 4.4-7.1 lb.in		

2 wires of the same gauge and nature per ADO connection

Selection

Description	Type	Packaging	Catalog number
Standard block grey	D 4/6.ADO	50	019903415
Standard block orange	D 4/6.ADO	50	019903516
Standard block blue	D 4/6.N.ADO	50	019903617
Standard block black	D 4/6.ADO	50	019907122
Standard block red	D 4/6.ADO	50	019906900
Standard block yellow	D 4/6.ADO	50	019903922
Standard block ivory	D 4/6.ADO	50	019907005
Standard block green	D 4/6.ADO	50	019904007

Accessories

Description	Type	Packaging	Catalog number	
End stop (light grey)	(screwless)	BADL 9 mm	50	039990302
	(with screw)	BAM2 9.9 mm	50	039996701
End section	grey	FEDAD1 3 mm	20	019933620
	blue	FEDAD1 3 mm	20	019933802
	yellow	FEDAD1 3 mm	20	019933903
Assembled jumper bar (with IP20 protection)	2 poles	BJM16 32 A	10	017666300
	3 poles	BJM16 32 A	10	017666401
	4 poles	BJM16 32 A	10	017666502
	5 poles	BJM16 32 A	10	017666603
	10 poles	BJM16 32 A	10	017666704
Shield connector		CBM5 0.5 mm	50	017874514
		CBM8 0.8 mm	50	017874615



BADL



FEDAD1



BJM16

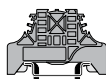

BAM2

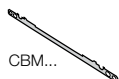

CBM...

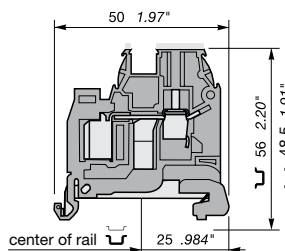

D 4/6.P.ADO

D 4/6.P.ADO - 1.5 mm² ground block with rail contact - 6 mm .238" spacing

Characteristics		IEC		UL	CSA
		NFC	DIN		
Wire size mm ² / AWG	Screw	Solid	0.2- 4 mm ²	22-10 AWG	22-10 AWG
		Stranded	0.22 - 4 mm ²		
Voltage	ADO	Solid	0.34 - 1.5 mm ²	22-16 AWG	22-16 AWG
		Stranded	0.34 - 1.5 mm ²		
Current		V	1000	600	600
Short circuit current (D4/6.PI.ADO)		A	17.5	18	18
Rated wire size		A / s	180 A/1s		
Wire stripping length (screw)		mm ² / AWG	1.5 mm ²	16 AWG	16 AWG
Recommended torque (screw)		mm / inches		9.5 mm / .37"	
		Nm / lb.in	0.5-0.8 / 4.4-7.1 lb.in		

2 wires of the same gauge and nature per ADO connection

Selection

Description	Type	Packaging	Catalog number
Ground block green body, yellow marking	D 4/6.P.ADO	50	019905001

Accessories

Description	Type	Packaging	Catalog number	
End section	yellow	FEDAD1 3 mm	20	019933903
	grey	FEDAD1 3 mm	20	019933620



FEDAD1

Feed through and ground terminal blocks

Insulation displacement

ADO - Screw clamp, \cup DIN 3

D 6/8... .ADO - 2.5 mm² blocks - 8 mm .315" spacing

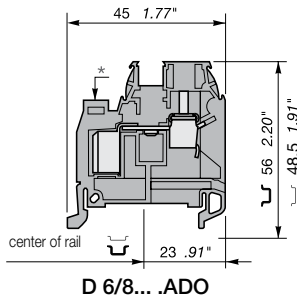

Characteristics		IEC		UL	CSA
		NFC	DIN		
Wire size mm ² / AWG	Screw	Solid	0.2- 10 mm ²	22-8 AWG	22- 8 AWG
		Stranded	0.22 - 6 mm ²		
	ADO	Solid	1 - 2.5 mm ²	16-14 AWG	16-14 AWG
		Stranded	1 - 2.5 mm ²		
Voltage		V	1000	600	600
Current		A	24	25	25
Short circuit current (D6/8.PI.ADO)		A / s	300 A/1s		
Rated wire size		mm ² / AWG	2.5 mm ²	14 AWG	14 AWG
Wire stripping length (screw)		mm / inches		12 mm / .47"	
Recommended torque (screw)		Nm / lb.in		0.8-1 Nm / 7.1-8.9 lb.in	

2 wires of the same gauge and nature per ADO connection

Selection

Description	Type	Packaging	Catalog number
Standard block grey	D 6/8.ADO	50	019904225
Standard block orange	D 6/8.ADO	50	019904326
Standard block blue	D 6/8.N.ADO	50	019904427
Standard block black	D 6/8.ADO	50	019907720
Standard block red	D 6/8.ADO	50	019907526
Standard block yellow	D 6/8.ADO	50	019907223
Standard block ivory	D 6/8.ADO	50	019907627
Standard block green	D 6/8.ADO	50	019907324

Accessories

Description	Type	Packaging	Catalog number	
End stop (light grey)	(screwless)	BADL 9 mm	50	039990302
	(with screw)	BAM2 9.9 mm	50	039996701
End section	grey	FEDAD1 3 mm	20	019933620
	blue	FEDAD1 3 mm	20	019933802
	yellow	FEDAD1 3 mm	20	019933903
Assembled jumper bar (with IP20 protection)	2 poles	BJMI8 41 A	10	017666916
	3 poles	BJMI8 41 A	10	017667013
	4 poles	BJMI8 41 A	10	017667100
	5 poles	BJMI8 41 A	10	017667201
	10 poles	BJMI8 41 A	10	017667302

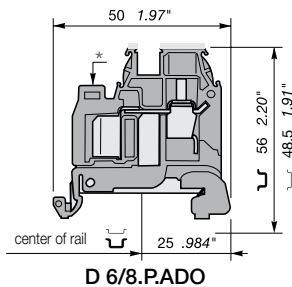
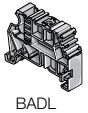
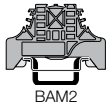

D 6/8.P.ADO - 2.5 mm² ground block with rail contact - 8 mm .315" spacing

Characteristics		IEC		UL	CSA
		NFC	DIN		
Wire size mm ² / AWG	Screw	Solid	0.2- 10 mm ²	22-8 AWG	22- 8 AWG
		Stranded	0.22 - 6 mm ²		
	ADO	Solid	1 - 2.5 mm ²	16-14 AWG	16-14 AWG
		Stranded	1 - 2.5 mm ²		
Short circuit current (D6/8.PI.ADO)		A / s	300 A/1s		
Rated wire size		mm ² / AWG	2.5 mm ²	14 AWG	14 AWG
Wire stripping length (screw)		mm / inches		12 mm / .47"	
Recommended torque (screw)		Nm / lb.in		0.8-1 Nm / 7.1-8.9 lb.in	

2 wires of the same gauge and nature per ADO connection

Selection

Description	Type	Packaging	Catalog number
Ground block green body, yellow marking	D 6/8.P.ADO	50	019911826

Accessories

Description	Type	Packaging	Catalog number	
End section	grey	FEDAD1 3 mm	20	019933620
	yellow	FEDAD1 3 mm	20	019933903



Fuse holder terminal blocks

5x20 mm .197x.787 in. and 5x25 mm .197x.984 in.

ADO - Screw clamp,  DIN 3

D 4/8.SF...I.ADO - 1.5 mm² blocks - 8 mm .315" spacing

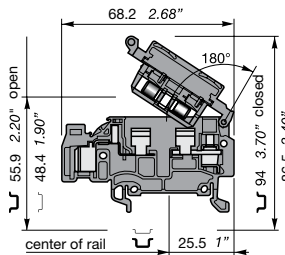

D 4/8.SF...I.ADO

Characteristics		IEC		UL	CSA
		NFC	DIN		
Wire size mm ² / AWG	Screw	Solid	0.2 - 4 mm ²	22-10 AWG	22-10 AWG
		Stranded	0.22 - 4 mm ²		
	ADO	Solid	0.34 - 1.5 mm ²	22-16 AWG	22-16 AWG
		Stranded	0.34 - 1.5 mm ²		
Voltage		V	630 ⊕	600 ⊕	600 ⊕
Current		A	6.3	10	10
Rated wire size		mm ² / AWG	1.5 mm ²	16 AWG	16 AWG
Wire stripping length (screw)		mm / inches	9.5 mm / .37"		
Recommended torque (screw)		Nm / lb.in	0.5-0.8 Nm / 4.4-7.1 lb.in		

2 wires of the same gauge and nature per ADO connection

Selection

Description	Type	Packaging	Catalog number
Standard block grey	D 4/8.SF.I.ADO	50	039978503
Standard block orange	D 4/8.SF.I.ADO	50	039978604
Block with Ø 2 mm test socket grey	D 4/8.SF2.I.ADO	50	039977712

D 4/8.SFL...I.ADO - 1.5 mm² blocks - 8 mm .315" spacing

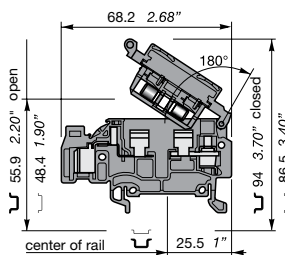

D 4/8.SFL...I.ADO

Characteristics		IEC		UL	CSA
		NFC	DIN		
Wire size mm ² / AWG	Screw	Solid	0.2 - 4 mm ²	22-10 AWG	22-10 AWG
		Stranded	0.22 - 4 mm ²		
	ADO	Solid	0.34 - 1.5 mm ²	22-16 AWG	22-16 AWG
		Stranded	0.34 - 1.5 mm ²		
Voltage		V	500	600	600
Current		A	6.3	10	10
Rated wire size		mm ² / AWG	1.5 mm ²	16 AWG	16 AWG
Wire stripping length (screw)		mm / inches	9.5 mm / .37"		
Recommended torque (screw)		Nm / lb.in	0.5-0.8 Nm / 4.4-7.1 lb.in		

2 wires of the same gauge and nature per ADO connection

Selection

Description	Type	Packaging	Catalog number
Standard block grey ②	D 4/8.SFL.I.ADO	50	039978012
Standard block grey ③	D 4/8.SFD.I.ADO	50	039978107

D 4/8.SNN.I.ADO - 1.5 mm² blocks - 8 mm .315" spacing - neutral switch block

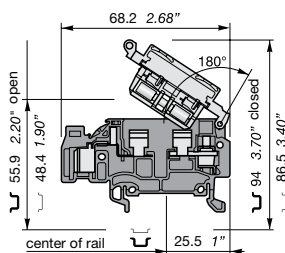

D 4/8.SNN.I.ADO

Characteristics		IEC		UL	CSA
		NFC	DIN		
Wire size mm ² / AWG	Screw	Solid	0.2 - 4 mm ²	22-10 AWG	22-10 AWG
		Stranded	0.22 - 4 mm ²		
	ADO	Solid	0.34 - 1.5 mm ²	22-16 AWG	22-16 AWG
		Stranded	0.34 - 1.5 mm ²		
Voltage		V	630	600	600
Current		A	10	10	10
Rated wire size		mm ² / AWG	1.5 mm ²	10/16 AWG	10/16 AWG
Wire stripping length (screw)		mm / inches	9.5 mm / .37"		
Recommended torque (screw)		Nm / lb.in	0.5-0.8 Nm / 4.4-7.1 lb.in		

2 wires of the same gauge and nature per ADO connection

Selection

Description	Type	Packaging	Catalog Number
Standard block grey body, blue grip	D 4/8.SNN.I.ADO	50	039977823

Accessories

Description	Type	Packaging	Catalog number	
End stop (light grey)	screwless	BADL 9 mm	50	039990302
	with screw	BAM2 9.9 mm	50	039996701
End section	grey	FEDAD10 1.5 mm	20	039975827

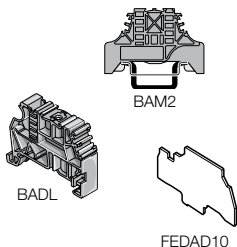

⊕ Terminal block insulation voltage. Working voltage according to fuse.
 ② Blown-fuse indicator by 110 V - 230 V neon lamp (leakage current with neon lamp : < 0,5 mA (110 V) - < 0,7 mA (230 V)).
 ③ Blown-fuse indicator by LED 24 V (+24V labeled) (leakage current with LED 24 V or 48 V < 4,5 mA).

Feed through and ground terminal blocks

Insulation displacement

ADO - ADO, DIN 3

D 1/5.ADO - 1 mm² blocks - 5 mm .198" spacing

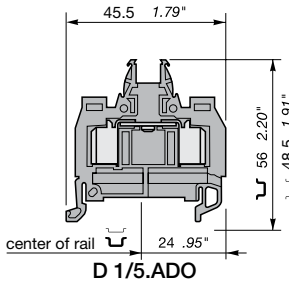

Characteristics		IEC		UL	CSA
		NFC	DIN		
Wire size mm ² / AWG	Screw	Solid	-	-	-
		Stranded	-	-	-
ADO		Solid	0.2 - 1 mm ²	24-18 AWG	24-18 AWG
		Stranded	0.22 - 1 mm ²		
Voltage		V	1000	600	600
Current		A	13.5	7	7
Short circuit current (D 1/5.PI.ADO)		A / s	120 A/1s		
Rated wire size		mm ² / AWG	1 mm ²	18 AWG	18 AWG

2 wires of the same gauge and nature per ADO connection

Selection

Description	Type	Packaging	Catalog Number
Standard block grey	D 1/5.ADO	50	019956324
Standard block orange	D 1/5.ADO	50	019956425
Standard block blue	D 1/5.N.ADO	50	019956526
Standard block black	D 1/5.ADO	50	019956627
Standard block red	D 1/5.ADO	50	019956720
Standard block yellow	D 1/5.ADO	50	019956902
Standard block ivory	D 1/5.ADO	50	019956801
Standard block green	D 1/5.ADO	50	019957007

Accessories

Description	Type	Packaging	Catalog number
End stop	screwless	BADL 9 mm	50 039990302
	with screw	BAM2 9.9 mm	50 039996701
End section	grey	FEMAD3 3 mm	20 019934105
	yellow	FEMAD3 3 mm	20 019934307
Assembled jumper bar (with IP20 protection)	2 poles	BJMI5 24 A	10 017627816
	3 poles	BJMI5 24 A	10 017627917
	4 poles	BJMI5 24 A	10 017628005
	5 poles	BJMI5 24 A	10 017628122
	10 poles	BJMI5 24 A	10 017628223
Shield connector		CBM5 0.5 mm	50 017874514
		CBM8 0.8 mm	50 017874615

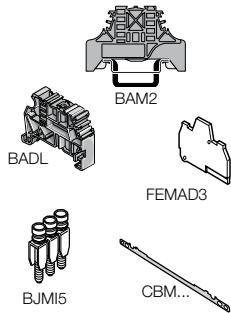

D 1/5.P.ADO - 1 mm² ground block with rail contact - 5 mm .198" spacing

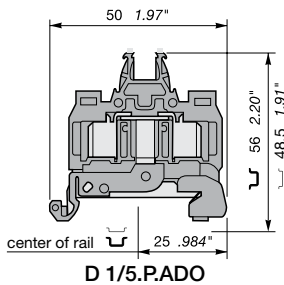

Characteristics		IEC		UL	CSA
		NFC	DIN		
Wire size mm ² / AWG	Screw	Solid	-	-	-
		Stranded	-	-	-
ADO		Solid	0.2 - 1 mm ²	24-18 AWG	24-18 AWG
		Stranded	0.22 - 1 mm ²		
Short circuit current (D 1/5.PI.ADO)		A / s	120 A/1s	-	-
Rated wire size		mm ² / AWG	-	-	-

2 wires of the same gauge and nature per ADO connection

Selection

Description	Type	Packaging	Catalog number
Ground block, green body/yellow marking	D 1/5.P.ADO	50	039903122

Accessories

Description	Type	Packaging	Catalog number
End section	yellow	FEMAD3 3 mm	20 019934307
	grey	FEMAD3 3 mm	20 019934105

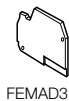



Feed through and ground terminal blocks

Insulation displacement

ADO - ADO, DIN 3

D 1,5/6... .ADO - 1.5 mm² blocks - 6 mm .238" spacing

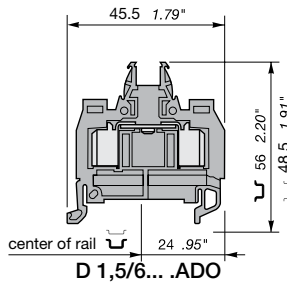

Characteristics

	Screw	Wire size mm ² / AWG	IEC		UL	CSA
			NFC	DIN		
Voltage	ADO	Solid	—	—	—	—
		Stranded	—	—	—	—
Current	ADO	Solid	0.34 - 1.5 mm ²	—	22-16 AWG	22-16 AWG
		Stranded	0.34 - 1.5 mm ²	—	22-16 AWG	22-16 AWG
Short circuit current (D 1,5/6.PI.ADO)		A / s	1000	600	600	600
Rated wire size		mm ² / AWG	17.5	18	18	18
			A / s	180 A/1s		
			1.5 mm ²	16 AWG	16 AWG	16 AWG

2 wires of the same gauge and nature per ADO connection

Selection

Description	Type	Packaging	Catalog number
Standard block grey	D 1,5/6.ADO	50	019905126
Standard block orange	D 1,5/6.ADO	50	019905227
Standard block blue	D 1,5/6.N.ADO	50	019905320
Standard block black	D 1,5/6.ADO	50	019908317
Standard block red	D 1,5/6.ADO	50	019908115
Standard block yellow	D 1,5/6.ADO	50	019908020
Standard block ivory	D 1,5/6.ADO	50	019908216
Standard block green	D 1,5/6.ADO	50	019905623

Accessories

Description	Type	Packaging	Catalog number	
End stop (light grey)	screwless	BADL 9 mm	50	039990302
	with screw	BAM2 9.9 mm	50	039996701
End section	grey	FEMAD3 3 mm	20	019934105
	yellow	FEMAD3 3 mm	20	019934307
Assembled jumper bar (with IP20 protection)	2 poles	BJMI6 32 A	10	017666300
	3 poles	BJMI6 32 A	10	017666401
	4 poles	BJMI6 32 A	10	017666502
	5 poles	BJMI6 32 A	10	017666603
	10 poles	BJMI6 32 A	10	017666704
Shield connector		CBM5 0.5 mm	50	017874514
		CBM8 0.8 mm	50	017874615

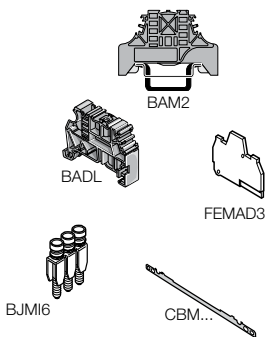

D 1,5/6.P.ADO - 1.5 mm² ground block with rail contact - 6 mm .238" spacing

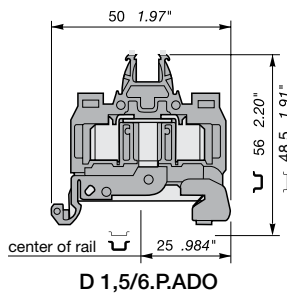

Characteristics

	Screw	Wire size mm ² / AWG	IEC		UL	CSA
			NFC	DIN		
Voltage	ADO	Solid	—	—	—	—
		Stranded	—	—	—	—
Current	ADO	Solid	0.34 - 1.5 mm ²	—	22-16 AWG	22-16 AWG
		Stranded	0.34 - 1.5 mm ²	—	22-16 AWG	22-16 AWG
Short circuit current		A / s	1000	600	600	600
Rated wire size		mm ² / AWG	17.5	18	18	18
			A / s	180 A/1s		
			1.5 mm ²	16 AWG	16 AWG	16 AWG

2 wires of the same gauge and nature per ADO connection

Selection

Description	Type	Packaging	Catalog Number
Ground block, green body/yellow marking	D 1,5/6.P.ADO	50	019909826

Accessories

Description	Type	Packaging	Catalog number	
End section	yellow	FEMAD3 3 mm	20	019934307
	grey	FEMAD3 3 mm	20	019934105





Feed through and ground terminal blocks

Insulation displacement

ADO - ADO, DIN 3

D 2,5/8... .ADO - 2.5 mm² blocks - 8 mm .315" spacing

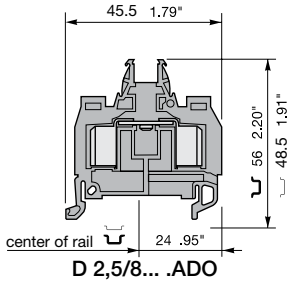

Characteristics		IEC		UL	CSA
		NFC	DIN		
Wire size mm ² / AWG	Screw	Solid	-	-	-
		Stranded	-	-	-
ADO	Screw	Solid	1 - 2.5 mm ²	16-14 AWG	16-14 AWG
		Stranded	1 - 2.5 mm ²	16-14 AWG	16-14 AWG
Voltage		V	1000	600	600
Current		A	24	25	25
Short circuit current (D 2,5/8.PI.ADO)		A / s		300 A/1s	
Rated wire size		mm ² / AWG	2.5 mm ²	16 AWG	16 AWG

2 wires of the same gauge and nature per ADO connection

Selection

Description	Type	Packaging	Catalog number
Standard block grey	D 2,5/8.ADO	50	019905906
Standard block orange	D 2,5/8.ADO	50	019906003
Standard block blue	D 2,5/8.N.ADO	50	019906120
Standard block black	D 2,5/8.ADO	50	019908925
Standard block red	D 2,5/8.ADO	50	019908713
Standard block yellow	D 2,5/8.ADO	50	019909210
Standard block ivory	D 2,5/8.ADO	50	019908824
Standard block green	D 2,5/8.ADO	50	019914804

Accessories

Description	Type	Packaging	Catalog number
End stop (light grey)	screwless	BADL 9 mm	50
	with screw	BAM2 9.9 mm	50
End section	grey	FEMAD3 3 mm	20
	yellow	FEMAD3 3 mm	20
Assembled jumper bar (with IP20 protection)	2 poles	BJMI8 41 A	10
	3 poles	BJMI8 41 A	10
	4 poles	BJMI8 41 A	10
	5 poles	BJMI8 41 A	10
	6 poles	BJMI8 41 A	10
	10 poles	BJMI8 41 A	10

10

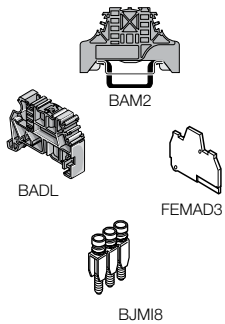

D 2,5/8.P.ADO - 2.5 mm² ground block with rail contact - 8 mm .315" spacing

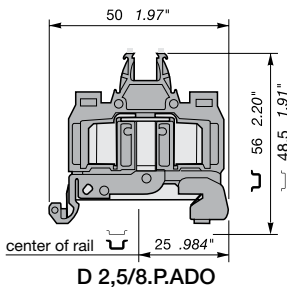

Characteristics		IEC		UL	CSA
		NFC	DIN		
Wire size mm ² / AWG	Screw	Solid	-	-	-
		Stranded	-	-	-
ADO	Screw	Solid	1 - 2.5 mm ²	16-14 AWG	16-14 AWG
		Stranded	1 - 2.5 mm ²	16-14 AWG	16-14 AWG
Short circuit current		A / s	300 A/1s	-	-
Rated wire size		mm ² / AWG	2.5 mm ²	14 AWG	14 AWG

2 wires of the same gauge and nature per ADO connection

Selection

Description	Type	Packaging	Catalog number
Ground block, green body/yellow marking	D 2,5/8.P.ADO	50	019909117

Accessories

Description	Type	Packaging	Catalog number
End section	yellow	FEMAD3 3 mm	20
	grey	FEMAD3 3 mm	20

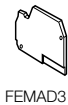



Fuse holder terminal blocks

5x20 mm .197x.787 in. and 5x25 mm .197x.984 in.

ADO - ADO, DIN 3

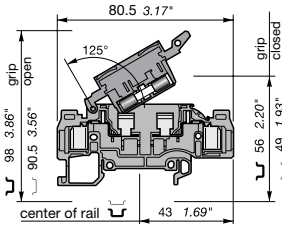

D 1,5/8.SFT.ADO

D 1,5/8.SFT.ADO - 1.5 mm² blocks - 8 mm .315" spacing

Characteristics

	Screw	Wire size mm ² / AWG	IEC		UL	CSA
			NFC	DIN		
Voltage	ADO	Solid	—	—	—	—
		Stranded	—	—	—	—
Current	ADO	Solid	0.34 - 1.5 mm ²	—	—	—
		Stranded	0.34 - 1.5 mm ²	—	—	—
Rated wire size			0.34 - 1.5 mm ²	0.34 - 1.5 mm ²	22-16 AWG	22-16 AWG
			V	630 ⌀	600 ⌀	600 ⌀
			A	6.3	8	10
			mm ² / AWG	1.5 mm ²	16 AWG	16 AWG

2 wires of the same gauge and nature per ADO connection

Selection

Description	Type	Packaging	Catalog number
Standard block grey	D 1,5/8.SFT.ADO	50	019920811
Standard block orange	D 1,5/8.SFT.ADO	50	019920912

With DIA. 2 or 2.3 mm screw test socket for test

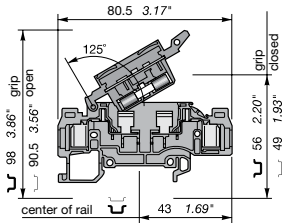

D 1,5/8.SF...T.ADO

D 1,5/8.SF...T.ADO - 1.5 mm² blocks - 8 mm .315" spacing

Characteristics

	Screw	Wire size mm ² / AWG	IEC		UL	CSA
			NFC	DIN		
Voltage	ADO	Solid	—	—	—	—
		Stranded	—	—	—	—
Current	ADO	Solid	0.34 - 1.5 mm ²	—	—	—
		Stranded	0.34 - 1.5 mm ²	—	—	—
Rated wire size			0.34 - 1.5 mm ²	0.34 - 1.5 mm ²	22-16 AWG	22-16 AWG
			V	500 ⌀	600 ⌀	600 ⌀
			A	6.3	8	10
			mm ² / AWG	1.5 mm ²	16 AWG	16 AWG

2 wires of the same gauge and nature per ADO connection

Selection

Description	Type	Packaging	Catalog number
Standard block grey ②	D 1,5/8.SFLT.ADO	50	019921123
Standard block orange ③	D 1,5/8.SFDT.ADO	50	019921224

With DIA. 2 or 2.3 mm screw test socket for test

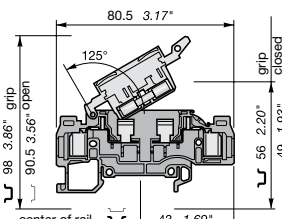

D 1,5/8.SNNT.ADO

D 1,5/8.SNNT.ADO - 1.5 mm² blocks - 8 mm .315" spacing

Characteristics

	Screw	Wire size mm ² / AWG	IEC		UL	CSA
			NFC	DIN		
Voltage	ADO	Solid	—	—	—	—
		Stranded	—	—	—	—
Current	ADO	Solid	0.34 - 1.5 mm ²	—	—	—
		Stranded	0.34 - 1.5 mm ²	—	—	—
Rated wire size			0.34 - 1.5 mm ²	0.34 - 1.5 mm ²	22-16 AWG	22-16 AWG
			V	630	600	600
			A	10	8	10
			mm ² / AWG	1.5 mm ²	16 AWG	16 AWG

2 wires of the same gauge and nature per ADO connection

Selection

Description	Type	Packaging	Catalog number
Standard block grey body, blue grip	D 1,5/8.SNNT.ADO	50	019921006

With DIA. 2 or 2.3 mm screw test socket for test

Accessories

Description	Type	Packaging	Catalog number	
End stop (light grey)	screwless	BADL 9 mm	50	039990302
	with screw	BAM2 9.9 mm	50	039996701
End section	grey	FEDAD7 1.5 mm	20	019938227

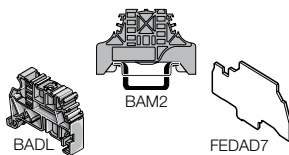

① Terminal block insulation voltage. Working voltage according to fuse.
 ② Blown-fuse indicator by 110 V - 230 V neon lamp (leakage current with neon lamp < 0,5 mA (110 V) - < 0,7 mA (230 V)).
 ③ Blown-fuse indicator by LED 24 V (+24V labeled) (leakage current with LED 24 V or 48 V < 4,5 mA).



Accessories

Insulation displacement Tools and test connectors

Tools

- Connection time savings
- Connection security
- Vibration proof
- Corrosion proof

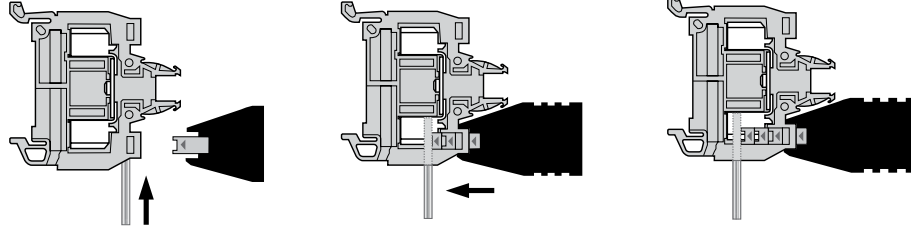
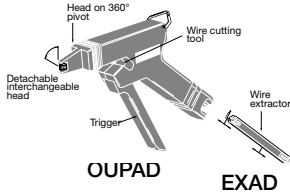

- 1 Position the wire (not stripped) in the opening on the side of the block.
- 2 Position the tool in the recess on top of the block.
- 3 Pull the trigger fully.

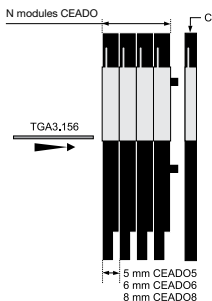
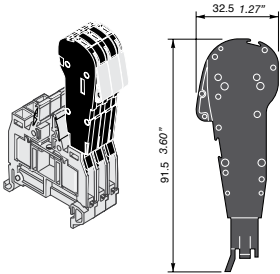
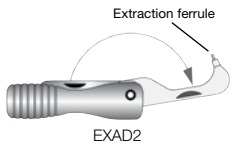
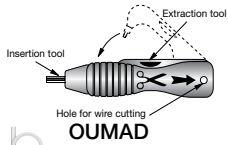

Selection

Description	Type	Packaging	Catalog number
Semi-automatic tool	OUPAD	1	017894404
Wire extractor	EXAD	1	017864611
Replacement head kit	OUTA	1	020528403
Hand tool kit	OUMAD	1	017946606
Pneumatic tool kit	OUTAD	1	020571011
Extraction tool kit	EXAD2	1	020572100

Test connectors on ADO jaw for terminal blocks

Selection

Description	Type	Packaging	Catalog number
Test connectors on ADO jaw	CEADO.5 spacing 5 mm	5	039934511
	CEADO.6 spacing 6 mm	5	039934612
	CEADO.6 spacing 8 mm	5	039934824
End module	CEADO.E th. 4.4 mm	1	039934115
Assembly rod for lever	TGA.156 DIA. 3 mm	1	020627714

Power terminal blocks with bistable foot and base mounting, \mathcal{U} DIN 3

D 35/27.FF - 35 mm² blocks - 27 mm 1.06" spacing

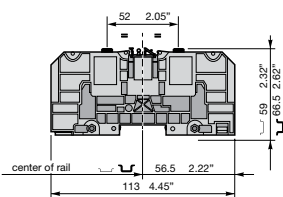

D 35/27.FF

Characteristics			IEC		UL / CSA
			NFC ①	DIN ②	
Wire size mm ² / AWG	Lug	Solid wire	2.5 - 35 mm ²		1 AWG max.
	C4	Stranded wire	2.5 - 50 mm ² 2.5 - 35 mm ²		
Voltage			1000	600	
Current			125	125	
Rated wire size			35 mm ²		1 AWG max.
Recommended wrench	Lug		H 10 mm		
	Central screw		6 mm Allen key		
Recommended torque	Lug		3 - 6 Nm / 26.1 - 52 lb.in		
	Central screw		6 - 12 Nm / 52 - 104 lb.in		

Selection

Description	Type	Packaging	Catalog number
Block with 2 studs M6 without cover grey	D 35/27.FF	10	019000120

Accessories

Description	Type	Packaging	Catalog number	
End stop	BADH 12 mm	50	011690027	
Rotating protective cover IP20 grey	CPUF35	10	019001616	
Jumper bar with CHc screw	2 poles	BJS27	5	020577213
	3 poles	BJS27	5	020577314

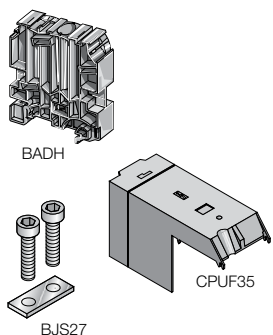

D 70/32.FF - 70 mm² blocks - 32 mm 1.26" spacing

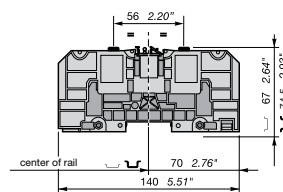

D 70/32.FF

Characteristics			IEC		UL / CSA
			NFC ①	DIN ②	
Wire size mm ² / AWG	Lug	Lug	6 - 95 mm ²		000 AWG max.
	C6	Solid wire	6 - 70 mm ²		
		Stranded wire	6 - 70 mm ²		
Voltage			1000	600	
Current			192	170	
Rated wire size			70 mm ²		000 AWG max.
Recommended wrench	Lug		H 13 mm		
	Central screw		6 mm Allen key		
Recommended torque	Lug		6 - 12 Nm / 52 - 104 lb.in		
	Central screw		6 - 12 Nm / 52 - 104 lb.in		

Selection

Description	Type	Packaging	Catalog number
Block with 2 studs M8 without cover grey	D 70/32.FF	10	019000221

Accessories

Description	Type	Packaging	Catalog number	
End stop	BADH 12 mm	50	011690027	
Rotating protective cover IP20 grey	CPUF70	10	019001717	
Jumper bar with CHc screw	2 poles	BJS32	5	020577415
	3 poles	BJS32	5	020577516

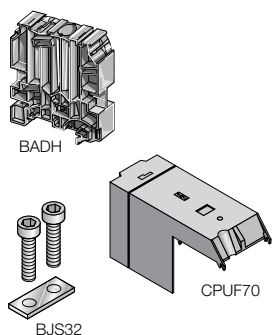

① NFC 20130
② DIN 46234

Power terminal blocks

with bistable foot and base mounting, \curvearrowright DIN 3

D 120/42.FF - 120 mm² blocks - 42 mm 1.65" spacing

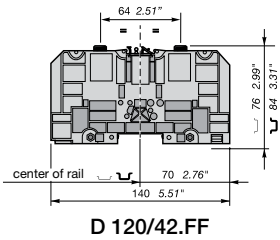

D 120/42.FF

Characteristics			IEC		UL / CSA
			NFC ①	DIN ②	
Wire size mm ² / MCM	Lug	Solid wire	6 - 150 mm ²		300 MCM max.
	C8	Stranded wire	6 - 120 mm ²		
Rated voltage	V		1000		600
Rated current nominal	A		269		269
Rated wire size nominal	mm ² / MCM		120 mm ²		300 MCM max.
Recommended wrench	Lug		H 17 mm		
	Central screw		6 mm Allen key		
Recommended torque	Lug		10 - 20 Nm / 87 - 174 lb.in		
	Central screw		6 - 12 Nm / 52 - 104 lb.in		

D 185/55.FF - 185 mm² blocks - 55 mm 2.16" spacing

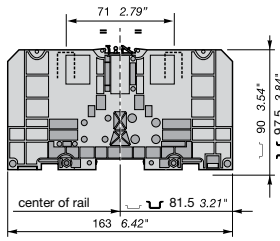

D 185/55.FF

Characteristics			IEC		UL / CSA
			NFC ①	DIN ②	
Wire size mm ² / MCM	Lug	Solid wire	25 - 240 mm ²		500 MCM max.
	C11	Stranded wire	6 - 185 mm ²		
Rated voltage	V		1000		600
Rated current nominal	A		353		353
Rated wire size nominal	mm ² / MCM		185 mm ²		500 MCM max.
Recommended wrench	Lug		H 19 mm		
	Central screw		6 mm Allen key		
Recommended torque	Lug		14 - 30 Nm / 121 - 261 lb.in		
	Central screw		6 - 12 Nm / 52 - 104 lb.in		

D 300/55.FF - 300 mm² blocks - 55 mm 2.16" spacing

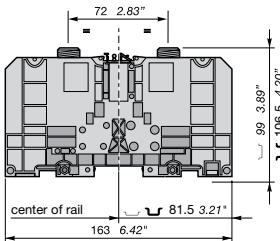

D 300/55.FF

Characteristics			IEC		UL / CSA
			NFC ①	DIN ②	
Wire size mm ² / MCM	Lug	Solid wire	25 - 300 mm ²		1000 MCM max.
	C4	Stranded wire	6 - 300 mm ²		
Voltage	V		1000		600
Current	A		520		460
Rated wire size	mm ² / MCM		300 mm ²		1000 MCM max.
Recommended wrench	Lug		H 24 mm		
	Central screw		6 mm Allen key		
Recommended torque	Lug		25 - 50 Nm / 217 - 434 lb.in		
	Central screw		6 - 12 Nm / 52 - 104 lb.in		

Selection

Description	Type	Packaging	Catalog number
Standard block without cover	Grey D 120/42.FF	5	019000322
Standard block without cover	Grey D 185/55.FF	5	019000423
Block 2 studs M16 without cover	Grey D 300/55.FF	5	019000524

Accessories

Description	Type	Packaging	Catalog number
End stop	BADH 12 mm	50	011690027
Rotating protective cover IP20	Grey CPUF120 ③	5	019001820
	Grey CPUF185 ④	5	019001921
Jumper bar with CHc screws	2 poles BJS42 ③	5	020577617
	3 poles BJS42 ③	5	020577710
Jumper bar with CHc screws	2 poles BJS551 ④	5	020577821
	3 poles BJS551 ④	5	020577922

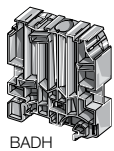

BADH

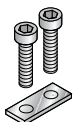

BJS42
BJS551

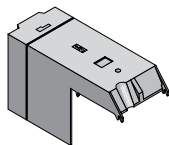

CPUF120
CPUF185

① NFC 20130
② DIN 46234
③ Only for block D 120/42.FF
④ For blocks D 185/55.FF and D 300/55.FF

Distribution blocks, single pole

Type BRU

Screw clamp, DIN 3

BRU 80 A

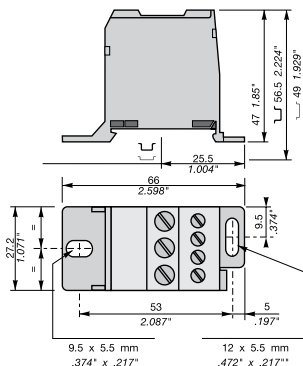

BRU 80 A

Characteristics		IEC		UL	CSA
		NFC	DIN		
Wire size	Solid	0.5 - 16 mm ²		22-6 AWG	18-6 AWG
	Stranded	0.5 - 10 mm ²			
Voltage	V	600		600	600
Current	A	80		80	80
Rated wire size	mm ² / AWG	3x16 mm ²		3x4 AWG	3x4 AWG
Inputs		6-16mm ²		8-4 AWG	—
Outputs (4)		2.5-16mm ²		14-10 AWG	—
Outputs (2) with ferrules		2.5-16mm ²		8-4 AWG	—
Recommended torque	Nm / lb.in	0.8 Nm / 7 lb.in			

Description	Type	Packaging	Catalog number
Grey body	BRU 80 A	1	03562085

BRU 125 A - 35 mm² block - 27 mm 1.063" spacing

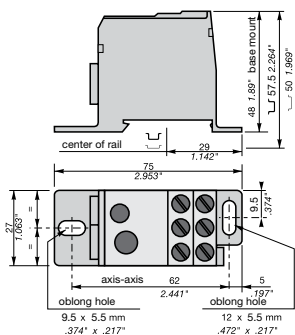

BRU 125 A

Characteristics		IEC		UL / CSA
		NFC	DIN	
Rated voltage	V	600		600
Rated current	A	125		115
Inputs: left input wire size	mm ² / AWG	10-35 mm ²		8-2 AWG
right input wire size	mm ² / AWG	6-16 mm ²		10- 6 AWG
Recommended torque	Nm / lb.in	3.5		31 lb.in
Recommended torque wrench		Allen key/4 mm		
Outputs: with ferrules	mm ² /AWG	4x2.5 to 16 mm ²		14 AWG to 6 AWG
without ferrules	mm ² /AWG	6x2.5 to 16 mm ²		14 AWG to 6 AWG
Recommended torque	Nm / lb.in	2 Nm		17.5 lb.in
Screwdriver		Posidriv Z2 or flat		

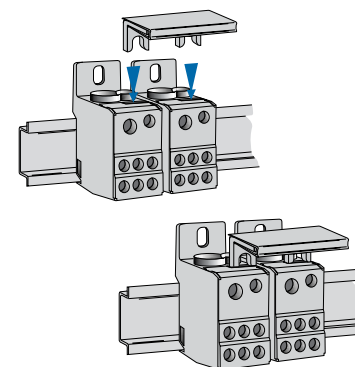

10

Description	Type	Packaging	Catalog number
Grey body	BRU 125 A	1	035620411

Description	Type	Packaging	Catalog number
End stop	BAM2 9.9 mm	50	020635116
Jumper bar	PCF.1.2	1	035620512 ⊕
	PCF.1.8	1	035620613 ⊕

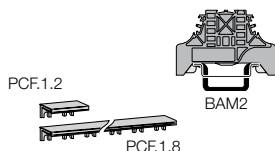

⊕ For BRU 125A only.

Distribution blocks, single pole

Type BRU

Screw clamp, DIN 3

BRU 160 A - 70 mm² block - 35.2 mm 1.388" spacing

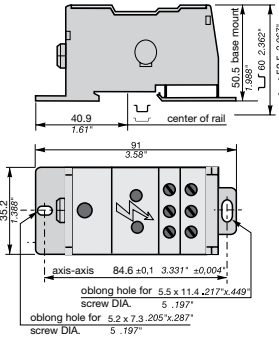

BRU 160 A

Characteristics		IEC		UL / CSA
		NFC	DIN	
Rated voltage	V	600	600	600
Rated current	A	160	160	160
Inputs (maximum wire size)				
left input wire size	mm ² /AWG	10-70 mm ²		8-00 AWG
right input wire size				
Recommended torque	Nm / lb.in	5		35.5 lb.in
Recommended torque wrench				Allen key/5 mm
Outputs: with ferrules	mm ² /AWG	6x2.5 to 16 mm ²		14 AWG to 6 AWG
without ferrules				
Recommended torque	Nm / lb.in	1.5 Nm		17.5 lb.in

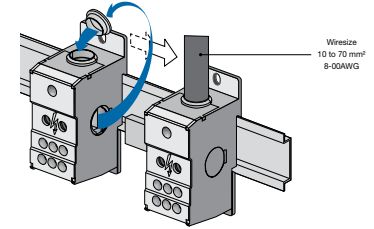

Selection

Description	Type	Packaging	Catalog number
Grey body	BRU 160 A	1	035620021

Accessories

Description	Type	Packaging	Catalog number
End stop	BAM2 9.9 mm	50	020635116
Busbar	BO 16/5 2 poles	1	035620116
	BO 16/5 3 poles	1	035620217
	BO 16/5 4 poles	1	035620310

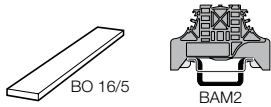

10

BRU 250 A - 120 mm² blocks - 44.5 mm 1.752" spacing

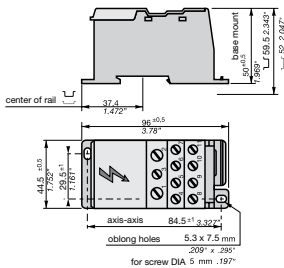

BAM2

Characteristics		IEC		UL / CSA
		NFC	DIN	
Rated voltage	V	600	600	600
Rated current	A	160	160	160
Inputs (mini)				
max. wire size	mm ² /AWG	35-120 mm ²		2-0000 AWG
Recommended torque	Nm / lb.in	19		170 lb.in
Recommended torque wrench				Allen key/6 mm
Outputs: with ferrules	mm ² /AWG	2x2.5 to 25 mm ²		2x14 AWG to 4 AWG
without ferrules		2x2.5 to 35 mm ²		2x14 AWG to 2 AWG
Recommended torque	Nm / lb.in	3.5 Nm		31 lb.in
Wire size with/without ferrule	mm ² /AWG	5x2.5 to 16		5x14 AWG to 6 AWG
Recommended torque	Nm / lb.in	2 Nm		18 lb.in
Wire size with/without ferrule	mm ² /AWG	4x2.5 to 10		4x14AWG to 8 AWG
Recommended torque	Nm / lb.in	2 Nm		18 lb.in

Selection

Description	Type	Packaging	Catalog number
Grey body	BRU 250 A	1	017965715
Black body	BRU 250 ALU	1	035620714

Accessories

Description	Type	Packaging	Catalog number
End stop	BAM2 9.9 mm	50	020635116
Copper lug		1	XUS003154
Replacement cover for BRU 250 A		1	XUS003157
Replacement cover for BRU 250 ALU		1	XUS003158



Distribution blocks, single pole

Type BRU

Screw clamp,  DIN 3

BRU 400 A - 185 mm² block - 44.5 mm 1.752" spacing

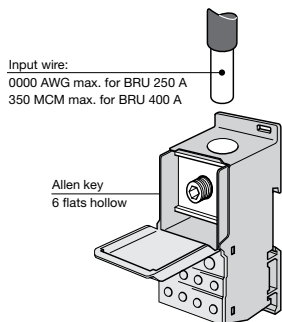

BRU 250 A
BRU 400 A

Characteristics

		IEC		UL / CSA
		NFC	DIN	
Rated voltage	V	600	600	
Rated current	A	400	310	
Inputs mini				
max. wire size	mm ² /AWG	95 - 185 mm ²	000 AWG-350 MCM	
Recommended torque	Nm / lb.in	25 Nm	230 lb.in	
Recommended torque wrench		Allen key/8 mm		
Outputs: with ferrules	mm ² /AWG	2x2.5 to 25	2x14 AWG to 4 AWG	
without ferrules		2x2.5 to 35	2x14 AWG to 2 AWG	
Recommended torque	Nm / lb.in	3.5 Nm	31 lb.in	
Wire size with/without ferrule	mm ² /AWG	5x2.5 to 16	5x14 AWG to 6 AWG	
Recommended torque	Nm / lb.in	2 Nm	18 lb.in	
Wire size with/without ferrule	mm ² /AWG	4x2.5 to 10	4x14 AWG to 8 AWG	
Recommended torque	Nm / lb.in	2 Nm	18 lb.in	

Selection

Description	Type	Packaging	Catalog number
Grey body	BRU 400 A	1	017965022

Accessories

Description	Type	Packaging	Catalog number
End stop	BAM2 9.9 mm	50	020635116
Replacement cover for BRU 400A		1	XUS003157

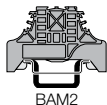

BAM2

Distribution blocks, single pole

Type BRU

Screw clamp,  DIN 3

BRU 115 A - 50 mm² block - 45 mm 1.77" spacing

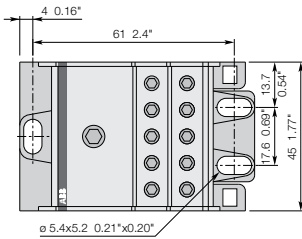

Characteristics		IEC	UL / CSA
Rated voltage	V	690	600
Rated current	A	125	115
Inputs mini			
Max. wire size	mm ² /AWG	10-50mm ²	8-2 AWG
Recommended torque	Nm / lb.in	6 Nm	31 lb.in
Recommended torque wrench		Allen key 6 flats/4 mm	
Outputs min			
Max wire size	mm ² /AWG	2.5 - 16 mm ²	14-4 AWG
Recommended torque	Nm / lb.in	3 Nm	17.5 lb.in

Selection

Description	Type	Packaging	Catalog number
Grey body	BRU 115	1	XUS002885

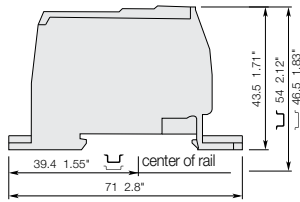

BRU 115 A

BRU 175 A - 70 mm² block - 45 mm 1.77" spacing

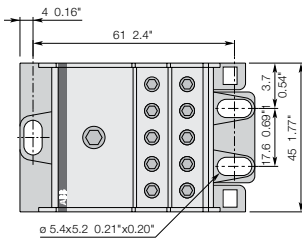

Characteristics		IEC	UL / CSA
Rated voltage	V	690	600
Rated current	A	175	175
Inputs mini			
Max. wire size	mm ² /AWG	16 - 70 mm ²	6 - 00 AWG
Recommended torque	Nm / lb.in	6 Nm	35.5 lb.in
Recommended torque wrench		Allen key 6 flats/5 mm	
Outputs min			
Max wire size	mm ² /AWG	2.5 - 16 mm ²	14 - 4 AWG
Recommended torque	Nm / lb.in	3 Nm	17.5 lb.in

Selection

Description	Type	Packaging	Catalog number
Grey body	BRU 175	1	XUS002886

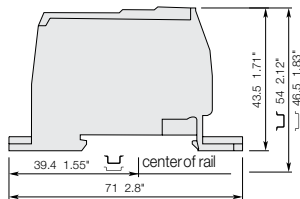

BRU 175 A

Distribution blocks, three pole

Type BRT

Screw clamp, DIN 3

BRT 115 A

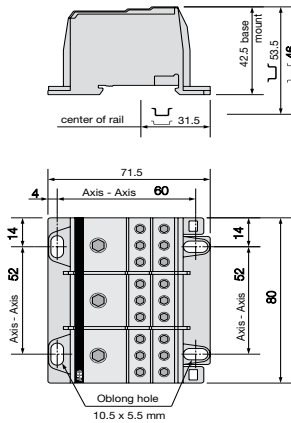

BRT 115 A

Characteristics		IEC		UL	CSA
		NFC	DIN		
Wire size	Solid	0.5 - 16 mm ²		Input 8 to 2 AWG (per pole)	8 to 2 AWG (per pole)
mm ² / AWG	Stranded	0.5 - 16 mm ²		Output 14 to 4 AWG (per pole)	14 to 4 AWG (per pole)
Voltage	V	690		600	600
Current	A	125		115	115
Rated wire size	mm ² / AWG	10-35 mm ²		—	—
Recommended torque input	Nm / lb.in			6 Nm / 31 lb. in.	
Recommended torque output				3 Nm / 17.5 lb. in.	
Wire stripping length					
Input	mm / inches			15 mm / 0.59"	
Output				11 mm / 0.43"	

Selection

Description	Type	Packaging	Catalog number
Grey body	BRT 115 A	1	035620926

BRT 175 A

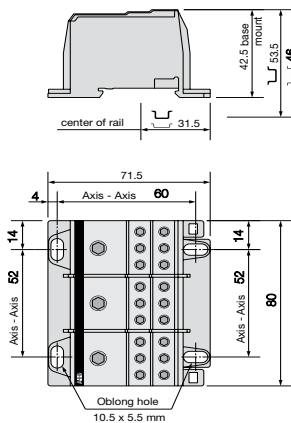

BRT 175 A

Characteristics		IEC		UL	CSA
		NFC	DIN		
Wire size	Solid	0.5 - 16 mm ²		Input 6 to 2/0 AWG (per pole)	6 to 2/0 AWG (per pole)
mm ² / AWG	Stranded	0.5 - 16 mm ²		Output 14 to 4 AWG (per pole)	14 to 4 AWG (per pole)
Voltage	V	690		600	600
Current	A	125		175	175
Rated wire size	mm ² / AWG	10-35 mm ²		—	—
Recommended torque input	Nm / lb.in			6 Nm / 31 lb. in.	
Recommended torque output				3 Nm / 17.5 lb. in.	
Wire stripping length					
Input	mm / inches			15 mm / 0.59"	
Output				11 mm / 0.43"	

Selection

Description	Type	Packaging	Catalog number
Grey body	BRT 175 A	1	035621021

Accessories

Description	Type	Packaging	Catalog number
End stop	BAM2 9.9 mm	50	020635116

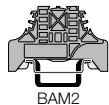

BAM2

Accessories

End stops

The end stops are mounted at the extremity of the terminal board assembly, giving additional support to the terminal blocks. For various types of marking, refer to the marker section

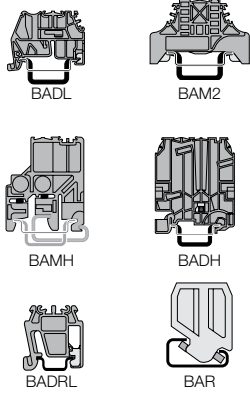

Description		Type		Packaging	Catalog number
End stop screwless DIN 3	grey	BADL	9 mm	50	039990302
End stop with screws DIN 3	light grey	BAM2	10 mm	50	039996701
	grey	BAM2	10 mm	50	020635116
	beige	BAM2	10 mm	50	029635100
High end stop with screws DIN 1 and DIN 3	grey	BAMH	9.1 mm	50	011483600
	beige	BAMH	9.1 mm	50	019483601
High end stop with screws DIN 3	grey	BADH	12 mm	50	011690027
End stop for miniblocks DIN 2	grey	BADRL	6.5 mm	50	019942021
Reversible end stop DIN 1	beige	BAR	10 mm	50	016451924

Mounting rails

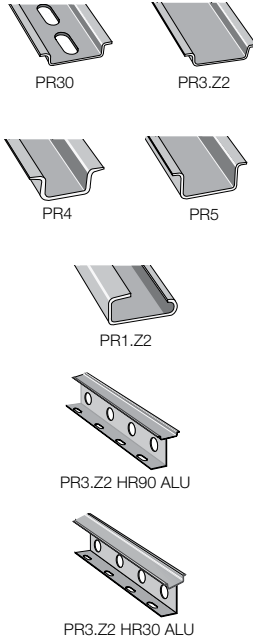

Symmetrical white passivated galvanized steel prepunched rail	PR30	1 m	1	010150804
		2 m	1	017322005
Symmetrical white passivated galvanized steel rail	PR3.Z2	1 m	1	010151310
		2 m	1	017430017
Symmetrical white passivated galvanized steel rail	PR5	1 m	1	010151512
		2 m	1	016870022
Symmetrical white passivated galvanized steel rail	PR4	1 m	1	010151714
		2 m	1	016850012
Asymmetrical zinc white passivated galvanized steel rail	PR2	1 m	1	010167300
Extruded aluminum, prepunched	PR3.Z2 HR90 ALU	1 m	1	XUS001735
		2 m	1	XUS001736
Extruded aluminum, prepunched	PR3.Z2 HR30 ALU	1 m	1	XUS001737
		2 m	1	XUS001738

Test devices

Test plug DIA. 2 mm		FC2		10	000786526
Test plug DIA. 4 mm		FC4		10	016786001
Test socket DIA. 2 mm for screw clamp/ ADO up to 8 mm spacing	one deck	AL2		50	016304321
	double deck	AL2		50	016307000
Test socket DIA. 4 mm for screw clamp blocks 8, 10, 12 mm spacing		AL4		50	016326201

Shield connectors

For screw clamp blocks: MA 2,5/2 ; MA 2,5/5.SNB ; M 4/6; MA 2,5/5.D2; M 4/6.D2	CBM5			50	017874514
	CBM5D			50	017353024
For spring clamp blocks: D 2,5/5.2L ; D 2,5/5.1.3L ; D 2,5/5.1.4L ; D 2,5/5.SNBT.2L	CBD5.2L			50	029107724
	CBM5			50	017874514
For ADO blocks: D 1/5.ADO ; D 1,5/6.ADO ; D 2,5/6.ADO ; D 4/6.ADO; D 2,5/5.SN.ADO ; D 4/6.SN.ADO; D 1/5.SNT2.ADO ; D 1,5/6.SNT2.ADO; D 4/6.D2.ADO ; D 1,5/6.D2.ADO	CBD1			1	017963406
	CBD2			50	017963507
	CBD2S			50	017840814

Shield terminals for collector bar

Shield diameter					
1,5 - 6,5	SFB.B1			10	020517014
5 - 11	SFB.B2			10	020517101
10 - 17	SFB.B3			10	020517202
16 - 24	SFB.B4			10	020517303
Collector bar 18 x 3 x 1000 mm	BO 318			10	020517505
Bar holder (isolated from ground)	DSPBO.PI			10	020517606
Bar holder (connected to the mounting rail)	DSPBO.P			10	020517707

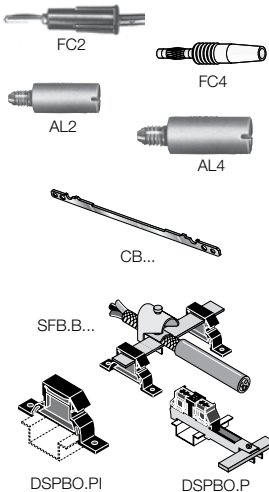

Accessories

DIN Rail cutters



RLCUT02

Economy DIN rail cutter

Description	Type	Packaging	Catalog number
DIN 3 only rail cutter	RLCUT02	1	XUS002837

Features

- Lightweight, (only 6 lb.)
- Clean cuts in 3 seconds or less
- Fully portable: no need to mount on a bench
- Easily cuts all 35 mm x 7.5 mm (DIN46277-3) DIN rails
- Small dimensions: only 13.5" x 2.75" x 4.75" (350 x 66 x 118 mm)
- Available from stock
- Economically priced
- One year warranty

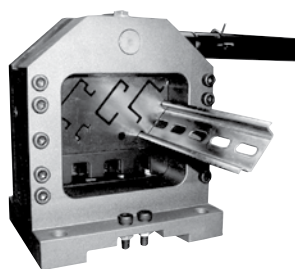

RLCUT01

DIN rail cutter

Description	Type	Packaging	Catalog number
DIN rail cutter	RLCUT01	1	XUS001772

Features

Cuts and punches:

- TS35 rail (35 mm x 7.5 mm standard symmetric rail)
- TS35C rail (35 mm heavy duty symmetric)
- TS35R rail (35 x 15 mm symmetric reinforced steel or aluminum)
- TS32 rail (32 mm asymmetric)

Also cuts:

- TS15 (15 mm miniature rail)
- 6 mm (~ 1/4") steel rods, threaded or not

Punches:

- An oblong hole 8.8 mm x 5 mm (0.35" x 0.20") in either direction on the axis of the rail.

Accessories included:

- 1m ruler (metric)
- End stop
- 730 mm (~28") high leverage handle

Accessories

Rail mounted receptacle



1SNA892461R1500

Selection

Description	Packaging	Catalog number
DIN rail mounted duplex receptacle	1	1SNA892461R1500

Technical data

Electrical ratings

Volts: 125
 Amps: 15 Amps Max.
 Wire range: 18-14 AWG
 Clamp torque: 3.5 - 5.3 lb. in. (0.4 - 0.6 Nm)

DIN rail mounting compatibility

Din 3 only

Materials information reference

Housing: 25% glass reinforced PA6/66
 Connectors: Chromium Oxide plated steel
 Operating temperatures: -40°C MIN +70°C MAX
 Flammability specs: Halogen-free, UL rated 94
 Ingress protection: IP20

Configuration

NEMA 5-15R

Color

Ivory

Approvals

UL, File # E233903

Approximate dimensions – (mm [in])

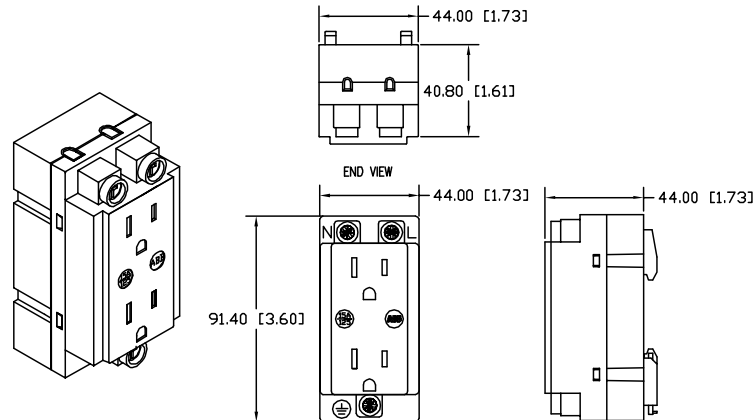

Marking

Marking for terminal blocks

Selection table

Markers for blocks :	RC410	RC 510	RC610	RC810	RC1010	RC55	RC65	RCAL85
Screw/ADO								
5 mm spacing	POSSIBLE	○	◐	◐	◐	○	◐	◐
6 mm spacing	POSSIBLE	POSSIBLE	○	◐	◐	POSSIBLE	○	◐
8 mm spacing	POSSIBLE	POSSIBLE	POSSIBLE	○	◐	POSSIBLE	POSSIBLE	○
10 mm spacing	POSSIBLE	POSSIBLE	POSSIBLE	POSSIBLE	○	POSSIBLE	POSSIBLE	
12 mm spacing	POSSIBLE	POSSIBLE	POSSIBLE	POSSIBLE	○	POSSIBLE	POSSIBLE	POSSIBLE
16 mm spacing	POSSIBLE	POSSIBLE	POSSIBLE	POSSIBLE	○	POSSIBLE	POSSIBLE	POSSIBLE
Spring								
4 mm spacing	○	◐	◐	◐	◐	◐	◐	◐
5 mm spacing	POSSIBLE	○	◐	◐	◐	○	◐	◐
6 mm spacing	POSSIBLE	POSSIBLE	○	◐	◐	POSSIBLE	○	◐
8 mm	POSSIBLE	POSSIBLE	POSSIBLE	○	◐	POSSIBLE	POSSIBLE	○
10 mm	POSSIBLE	POSSIBLE	POSSIBLE	POSSIBLE	○	POSSIBLE	POSSIBLE	POSSIBLE
12 mm	POSSIBLE	POSSIBLE	POSSIBLE	POSSIBLE	○	POSSIBLE	POSSIBLE	POSSIBLE
16 mm	POSSIBLE	POSSIBLE	POSSIBLE	POSSIBLE	○	POSSIBLE	POSSIBLE	POSSIBLE
Power								
	POSSIBLE	POSSIBLE	POSSIBLE	○	◐	◐	◐	◐

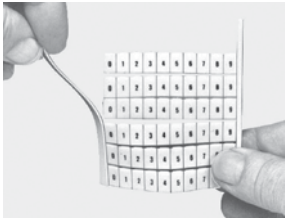

1

Remove one of the side bands of the card.

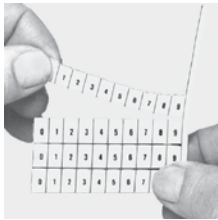

2

Separate the chosen strip from the rest of the card.

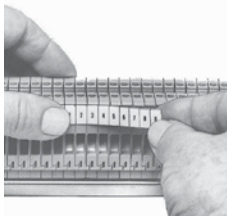

3

Press the first marker in place, hold it and slide your thumb on the rest of the strip.

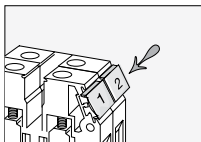

Horizontal marking

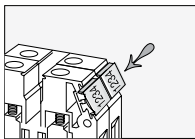

Vertical marking

Possible mounting : POSSIBLE

Recommended mounting : ○

Impossible mounting : ◐

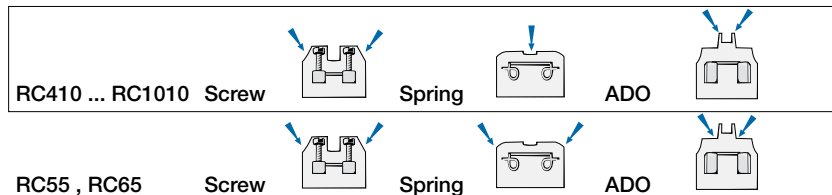

Marking for terminal blocks

Standard RC marker cards

9 & 15 Digit catalog number selection

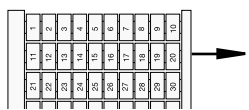
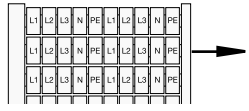
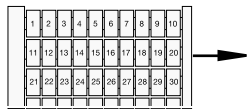
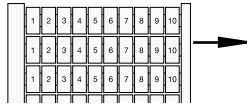
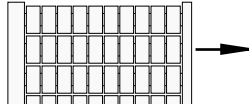

9 Digit catalog numbers

Marker sizes	RC410	RC55	RC510	RC65	RC610	RC810	RC1010
Blank cards	022900015	023000012	023100007	023200000	023300001	023400002	023800016
Horizontal marking							
10 strips from 1 to 10	022900203	023000200 (5)	023100225 (25)	023200226 (5)	023300227 (25)	023400220	1 to 8 023800204
10 strips from 11 to 20	022900304	023000301 (2)	023100326 (10)	023200327 (2)	023300320 (10)	023400321	9 to 16 023800305
10 strips from 21 to 30	022900405	023000402	023100427 (6)	023200420	023300421 (6)	023400422	17 to 24 023800406
10 strips from 31 to 40	022900506	023000503	023100520 (4)	023200521	023300522 (4)	023400523	25 to 32 023800507
10 strips from 41 to 50	022900607	023000604	023100621 (3)	023200622	023300623 (3)	023400624	33 to 40 023800600
10 strips from 51 to 60	022900700	023000705	023100722 (2)	023200723	023300724 (2)	023400725	41 to 48 023800701
10 strips from 61 to 70	022900811	023000816	023100803 (2)	023200804	023300805 (2)	023400806	49 to 56 023800812
From 1 to 100	022903002	023003007 (2)	023103024 (15)	023203025 (2)	023303026 (15)	023403027	1 to 80 023803003
From 101 to 200	022903127	023003124	023103111 (2)	023203112	023303113 (2)	023403114	81 to 160 023803120
20 times L1-L2-L3-N-PE		023013125	023113112	023213113	023313114 (2)		
Vertical marking							
10 strips from 1 to 10	022904101	023004106	023104123 (5)	023204124	023304125 (5)	023404126	1 to 8 023805104
10 strips from 11 to 20	022904202	023004207	023104224 (3)	023204225	023304226 (3)	023404227	9 to 16 023805205
10 strips from 21 to 30	022904303	023004300	023104325 (2)	023204326	023304327 (2)	023404320	17 to 24 023805306
10 strips from 31 to 40	022904404	023004401	023104426 (2)	023204427	023304420 (2)	023404421	25 to 32 023805407
From 1 to 100	022906010	023006015	023106002 (8)	023206003	023306004 (8)	023406005	1 to 80 023808006

15 Digit catalog numbers

Marker sizes	RC410	RC55	RC510	RC65	RC610	RC810	RC1010
Blank cards	1SNA229000R1500	1SNA230000R1200	1SNA231000R0700	1SNA232000R0000	1SNA233000R0100	1SNA234000R0200	1SNA238000R1600
Horizontal marking							
10 strips from 1 to 10	1SNA229002R0300	1SNA230002R0000 (5)	1SNA231002R2500 (25)	1SNA232002R2600 (5)	1SNA233002R2700 (25)	1SNA234002R2000	1 to 8 1SNA238002R0400
10 strips from 11 to 20	1SNA229003R0400	1SNA230003R0100 (2)	1SNA231003R2600 (10)	1SNA232003R2700 (2)	1SNA233003R2000 (10)	1SNA234003R2100	9 to 6 1SNA238003R0500
10 strips from 21 to 30	1SNA229004R0500	1SNA230004R0200	1SNA231004R2700 (6)	1SNA232004R2000	1SNA233004R2100 (6)	1SNA234004R2200	17 to 24 1SNA238004R0600
10 strips from 31 to 40	1SNA229005R0600	1SNA230005R0300	1SNA231005R2000 (4)	1SNA232005R2100	1SNA233005R2200 (4)	1SNA234005R2300	25 to 32 1SNA238005R0700
10 strips from 41 to 50	1SNA229006R0700	1SNA230006R0400	1SNA231006R2100 (3)	1SNA232006R2200	1SNA233006R2300 (3)	1SNA234006R2400	33 to 40 1SNA238006R0000
10 strips from 51 to 60	1SNA229007R0000	1SNA230007R0500	1SNA231007R2200 (2)	1SNA232007R2300	1SNA233007R2400 (2)	1SNA234007R2500	41 to 48 1SNA238007R0100
10 strips from 61 to 70	1SNA229008R1100	1SNA230008R1600	1SNA231008R0300 (2)	1SNA232008R0400	1SNA233008R0500 (2)	1SNA234008R0600	49 to 56 1SNA238008R1200
From 1 to 100	1SNA229030R0200	1SNA230030R0700 (2)	1SNA231030R2400 (15)	1SNA232030R2500 (2)	1SNA233030R2600 (15)	1SNA234030R2700	1 to 80 1SNA238030R0300
From 101 to 200	1SNA229031R2700	1SNA230031R2400	1SNA231031R1100 (2)	1SNA232031R1200	1SNA233031R1300 (2)	1SNA234031R1400	81 to 160 1SNA238031R2000
20 times L1-L2-L3-N-PE		1SNA230131R2500	1SNA231131R1200 (2)	1SNA232131R1300	1SNA233131R1400 (2)		
Vertical marking							
10 strips from 1 to 10	1SNA229041R0100	1SNA230041R0600	1SNA231041R2300 (5)	1SNA232041R2400	1SNA233041R2500 (5)	1SNA234041R2600	1 to 8 1SNA238051R0400
10 strips from 11 to 20	1SNA229042R0200	1SNA230042R0700	1SNA231042R2400 (3)	1SNA232042R2500	1SNA233042R2600 (3)	1SNA234042R2700	9 to 6 1SNA238052R0500
10 strips from 21 to 30	1SNA229043R0300	1SNA230043R0000	1SNA231043R2500 (2)	1SNA232043R2600	1SNA233043R2700 (2)	1SNA234043R2000	17 to 24 1SNA238053R0600
10 strips from 31 to 40	1SNA229044R0400	1SNA230044R0100	1SNA231044R2600 (2)	1SNA232044R2700	1SNA233044R2000 (2)	1SNA234044R2100	25 to 32 1SNA238054R0700
From 1 to 100	1SNA229060R1000	1SNA230060R1500	1SNA231060R0200 (8)	1SNA232060R0300	1SNA233060R0400 (8)	1SNA234060R0500	1 to 80 1SNA238080R0600

Marking systems

Custom marking

Custom marking

Use the table below to select the card type based on the marker size desired and the thickness of the terminal block. Select the top marking strip based on the terminal block thickness. For your ordering convenience, we have provided a top marking continuous strip template on page 10.121.

Recommended alphanumeric
for ease of reading.

Card Type	Use With Terminal Block Thickness	One or Two Lines/Marker	
		Vertical Marking	Horizontal Marking
RC410, large 4 mm	4 mm	8	2
RC55, small 5 mm	5 mm	4	3
RC510, large 5 mm	5 mm	8	4
RC65, small 6 mm	6 mm	4	3
RC610, large 6 mm	6 mm	8	5
RC810, large 8 mm	8 mm and larger	8	6
RC1010, large 10 mm	10 mm and larger	8	6
Top Marking Card RCT610	6 mm	8	5
RCT810	8 mm	8	6
Top Marking Continuous Strip RTM7	6 mm to 12.5 mm	1-3	1-3
RTM9	16 mm	1-4	1-4

MARKER CARD

REFERENCE (To be supplied by customer)		
abcdefgh abcdefgh	12345678	

VERTICAL MARKING:
Part of 100 marker card,
shown above.

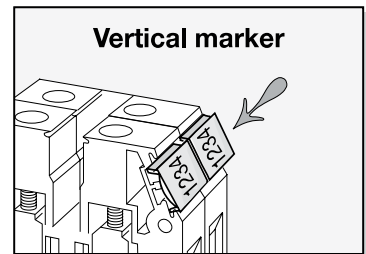

Vertical marker

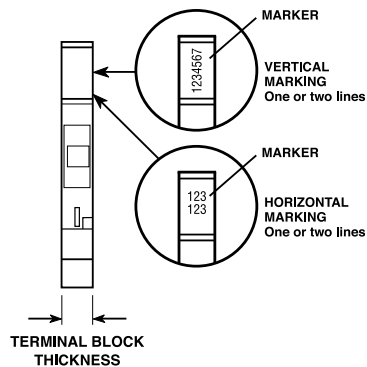

MARKER CARD

REFERENCE (To be supplied by customer)		
abc	123 123	

HORIZONTAL MARKING:
Part of 100 marker card,
shown above.

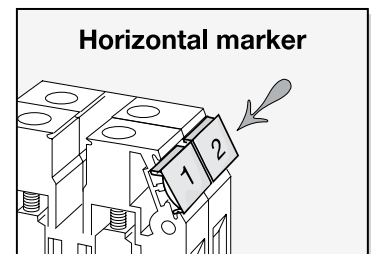

Horizontal marker

TOP MARKING CONTINUOUS STRIP

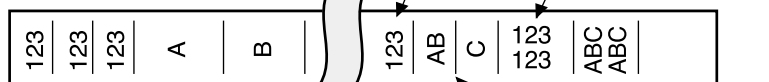

See table above for marker specifications.

Line between blocks does not extend to edge

Vertical and horizontal marking can be mixed on a marker card or on a top marking strip.

Custom markers Order form

TO AVOID MISTAKES, PLEASE TYPE OR PRINT CLEARLY. INDICATE CAPITAL OR LOWER CASE LETTERS AS DESIRED. EACH MARKER WILL BE PRINTED EXACTLY AS YOU SPECIFY BELOW.

For consecutive marking, start at the top in the left most column and proceed to the bottom. Then start at the top in the next column to the right and proceed to the bottom. Repeat for other columns.

1 2 3 4																				
5 6 7																				

REFERENCE

- Vertical Marking →
- Horizontal Marking →
- For consecutive marking, mark from top to bottom. →

For each marker card specify your reference number, card type (RC55, RC610, RC7610 etc.), quantity, and marking direction. Call for price. If you prefer that Entelec select the card type, enter your terminal block P/N in the reference column.

Reference	Card Type	Quantity	Marking Direction	
			V	H

Ordered by: P.O. # _____

NAME _____

COMPANY _____

ADDRESS _____ MAIL STOP _____

CITY _____ STATE/PROVINCE _____ ZIP/CODE _____

PHONE () _____ EXT _____

FAX () _____ E-MAIL _____

REFERENCE NO(S) _____

Custom top marker continuous strips

Order form

How To Order Top Marker Continuous Strips

Entrelec supplies computer marked top marker continuous strips, RTM7 and RTM9, in lengths to 350 mm. The number of printed markers depends on the terminal block width.

To Specify Marker Spacing

The spacing between markers is equal to each terminal block's width. Use the ruler (drawn in mm to actual size and shown below the marking strip template) to measure the spacing desired between markers. To ensure accuracy, indicate the spacing just

above each marker. Draw vertical lines on the top marker strip template to separate markers. Our plotter will print these vertical lines onto your marker strip.

To Specify Alphanumerics

To avoid mistakes, please print clearly. Indicate capital or lower case letters as desired. Each top marker strip will be printed exactly as you specify on the template. See ordering examples.

(TIP: You may find the blank top marking template, below, easier to use when photocopied at twice the size.)
For additional copies, please photocopy the template.

ORDER FORM

THIS MARKER STRIP IS FOR USE ON TERMINAL BLOCKS WITH:

- 6, 8, 9.5, 10, 12, AND 12.5 MM WIDTHS
- 16 MM WIDTHS

Ordered By: _____ P.O. # _____

NAME _____

COMPANY _____

ADDRESS _____ MAIL STOP _____

CITY _____

STATE/PROVINCE _____ ZIP/CODE _____

PHONE () _____ EXT _____

FAX () _____

E-MAIL _____

REFERENCE NO(S) _____

ORDERING EXAMPLES

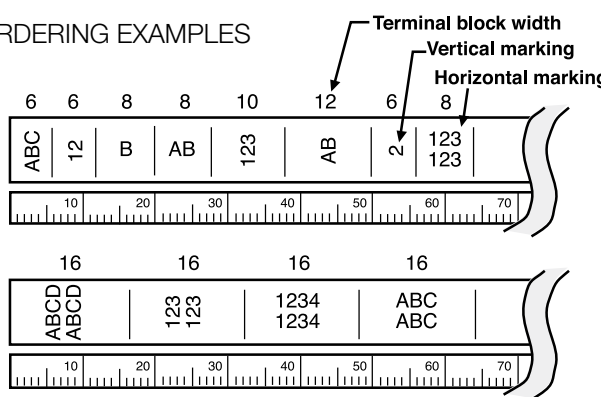

Special Instructions

For blocks with 6-12.5 mm spacing: You can use 1-3 alphanumeric for vertical marking. For horizontal marking, the number of alphanumeric depends on the terminal block width. For ease of reading, 1-3 alphanumeric per row are recommended for blocks with 6-12.5 mm spacing.

For blocks with 16 mm spacing: For ease of reading, for vertical or horizontal marking, 1-4 alphanumeric per row are recommended for blocks with 16 mm spacing.

TOP MARKER CONTINUOUS STRIP TEMPLATE

The number of markers depends on the terminal block width (spacing). Draw vertical lines on the top marker strip template to separate markers. To ensure accuracy, indicate the terminal block width in mm, just above each marker. A line will be printed between each marker.

To avoid mistakes, please print clearly.

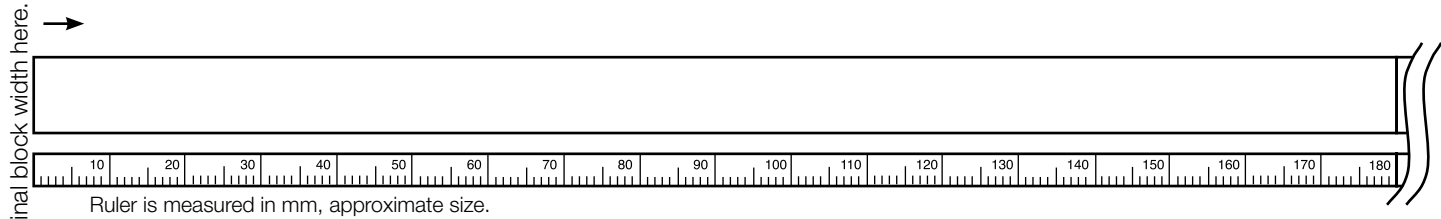
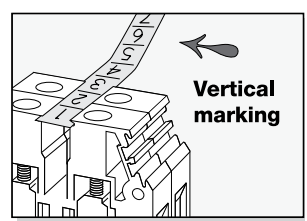
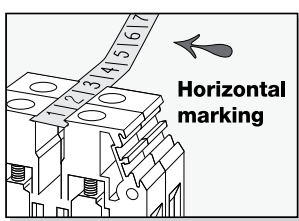

Ruler is measured in mm, approximate size.

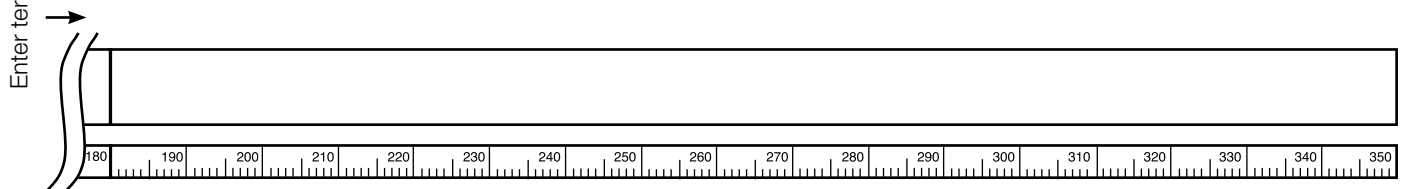

Marking systems AMS 500

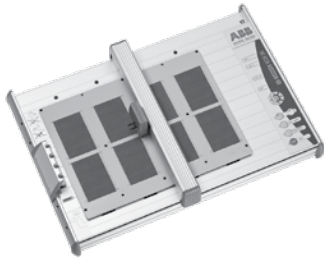

Marking table

Marking table

Description	Type	Packaging	Catalog number
Complete plotter kit	AMS 500	1	XUSP02636
Kit includes:			
1 Plotter, Model AMS500			
1 Template for 8 RC/RCT marker cards			
1 Plotter pen (.35 mm)			
5 Ink cartridges			
2 Cleaning cartridges			
1 Cleaner waste bottle			

Other available accessories

Description	Packaging	Catalog number
Ink cartridges (5)	1	XUSP01134
Plotter pen ink (30 ml bottle)	1	XUSP02530
Cleaning cartridge (2)	1	XUSP01135
Plotter pen cleaning fluid (50 ml bottle)	1	XUSP02531
Cleaner waste bottle	1	XUSP01139
Plotter pen (.18mm)	1	XUSP01551
Plotter pen (.25mm)	1	XUSP01132
Plotter pen (.35mm)	1	XUSP01133
Plotter pen (.50mm)	1	XUSP01552
Plotter pen (.70mm)	1	XUSP01548
Plotter pen (1.00mm)	1	XUSP01549
Disposable pen ED ink - Black (.18mm)	1	XUSP03511
Disposable pen ED ink - Blue (.18mm)	1	XUSP03512
Disposable pen ED ink - Red (.18mm)	1	XUSP03513
Disposable pen ED ink - Green (.18mm)	1	XUSP03514
Disposable pen ED ink - Black (.25mm)	1	XUSP03342
Disposable pen ED ink - Blue (.25mm)	1	XUSP03343
Disposable pen ED ink - Red (.25mm)	1	XUSP03344
Disposable pen ED ink - Green (.25mm)	1	XUSP03345
Disposable pen ED ink - Black (.35mm)	1	XUSP03346
Disposable pen ED ink - Blue (.35mm)	1	XUSP03347
Disposable pen ED ink - Red (.35mm)	1	XUSP03348
Disposable pen ED ink - Green (.35mm)	1	XUSP03349
Pen adaptor for permanent marker	1	XUSP03221
RC/RCT template (8 cards)	1	XUSP02633
RTM 7/9 template	1	XUSP01138
RPB-12 template (PCB strips)	1	XUSP01550
Pads for RC/RCT template	1	XUSP02629
Pads for RTM template	1	XUSP02630
Service kit for pen maintenance	1	XUSP02861

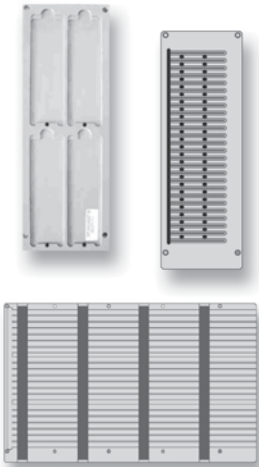

Templates

Additional terminal block products

This Terminal Block section represents just a portion of the ABB terminal block product offering. For the complete offering please visit our website at www.abb.com/lowvoltage and follow the Terminal Block link on the left side of the page.

Marking systems

HTP500 thermal transfer printer



HTP500

Description

- Excellent print quality, resolution: 300 dpi
- Fast printing: up to 5,000 markers per hour
- Excellent marking durability
- Ease and flexibility of use in automatic, semi-automatic or manual mode



HTP500-FEED



HTP500-PL2



HTP500-PL2



RIB-B



HTP500

Ordering details

Description	Type	Package	Catalog number
Full kit including:	HTP500 KIT	–	1SNA235700R1500
- 1 HTP500 thermal transfer printer	HTP500	–	–
- software for HTP500 thermal transfer printer	HTS500	1	1SNA235702R0300
- support table	HTP500-BAS	1	1SNA235706R0700
- universal feeder for marker cards	HTP500-FEED	1	1SNA235703R0400
- support plate for ABB terminal block markers	HTP500-PL2	1	1SNA235705R0600
- universal support plate for wire markers	HTP500-PL	1	1SNA235704R0500
- black ribbon cassette	RIB-B	3	1SNA235710R0600
- cleaning cassette	HTP500-CLEAN	1	1SNA235714R2600
- power supply cable	HTP500-PW	1	1SNA235709R1200
- parallel cable	HTP500-LPT	1	1SNA235708R1100
- USB/parallel adapter cable	HTP500-USB	1	1SNA235719R0300
- wooden box for HTP500 kit	HTP500-WB	1	1SNA235717R2100

10

Feeders and support plates

Description	Type	Package	Catalog number
Universal feeder for marker cards	HTP500-FEED	1	1SNA235703R0400
Support plate for ABB terminal block markers	HTP500-PL2	1	1SNA235705R0600

Accessories

Description	Type	Package	Catalog number
Black ribbon cassette	RIB-B	3	1SNA235710R0600
Red ribbon cassette for identification plates and adhesive labels	RIB-R	3	1SNA235711R2300
Red ribbon cassette for terminal blocks and wire markers	RIB-RS	3	1SNA235718R0200
Cleaning cassette	HTP500-CLEAN	1	1SNA235714R2600
Standard cleaning roll ø18	HTP500-ROLL	1	1SNA235715R2700
Printing head	HTP500-PRINT	1	1SNA235716R2000
Power supply cable	HTP500-PW	1	1SNA235709R1200
Parallel cable	HTP500-LPT	1	1SNA235708R1100
USB/parallel adapter cable	HTP500-USB	1	1SNA235719R0300
Dust cover for HTP500 and AMS 500 systems	DUST COVER	1	1SNA360161R1500
Wooden box for HTP500 kit	HTP500-WB	1	1SNA235717R2100

ABB's know-how provides the solution for your wiring.

Interfast pre-wiring system is recognized as a smart and efficient solution for a wide range of applications in various markets.

With its set of products fully designed to make your PLC wiring easy, Interfast meets all your requirements: relay switching, optocoupler isolation, or circuit protection.

Interfast can be used in the following sectors:

- Automotive
- Cement
- Chemical and petrochemical
- Electric power
- Metals
- Mining
- Oil & gas
- Pulp & paper
- Town planning infrastructures
- Water and wastewater.

ABB Exclusivity

Interfast MS - Modular system based on terminal block technology

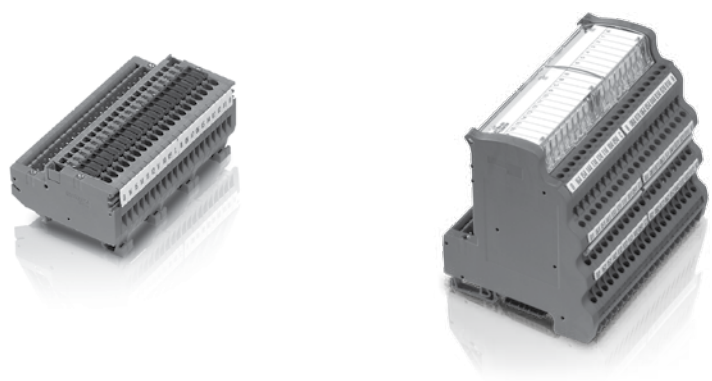

Interfast PCB - Standard or compact modules

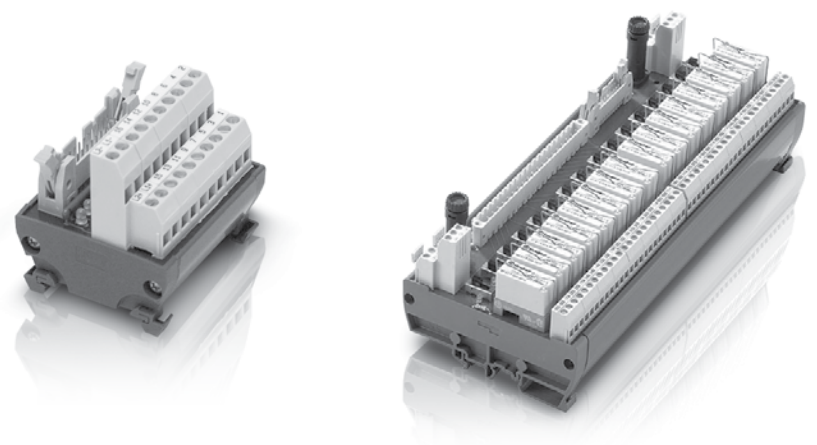

Interfast
Terminal blocks

Make your PLC wiring easy!

Connecting a PLC to components is hard work.

Transferring the different signals from your PLC to terminal blocks, using a single-wire connection system, requires a lot of time and accuracy. Fortunately, we have a solution for you!

Forget about the countless wires and the risk of contact reversal! Try Interfast, the pre-wiring system for PLCs by ABB.

You want to gain more space in your cabinet, try our new ultra-compact interface modules!

With a 50mm width and optimized dimensions, you gain up to 60% more space.

Save up to 98%
of installation time

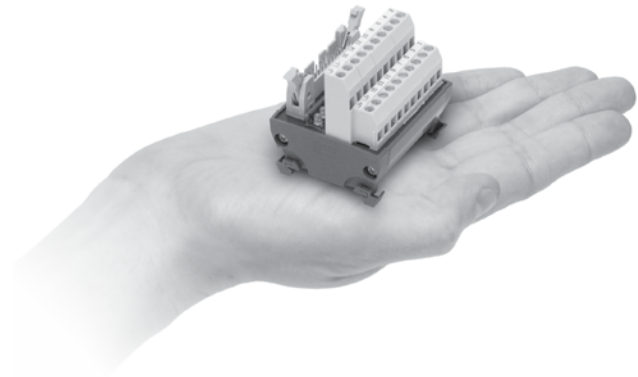

The benefits that make Interfast so competitive, user-friendly and flexible:

You optimize the space in your cabinet.

Our compact and ultra-compact interface modules ensure components are easy to handle inside the cabinet.

You reduce your costs.

Your wiring is less expensive since it takes less time. Plus, your consumption of cables, terminal blocks and other elements used in a classic wiring system, is dramatically reduced.

You save time.

The time you save on the wiring can be used for more demanding tasks.

Main features of our interface modules:

- 1 to 4-wire connection
- Input voltage up to 250 V
- Current up to 2 A
- Disconnect and protect channels
- Signal indicators
- Test points for current and voltage measurement
- IP20 protection
- PLC protection with fuse and I/O isolation (2.5 kV)
- Heavy-duty industrial connectors
- Relay for switching 16 A/250 V
- Pluggable relays and optocouplers
- Forcing and interrupting relay control
- Interface modules dedicated to solenoid valve control
- Various accessories to make your installation and maintenance easy
- More than 50 interface modules and 4 lengths of cables.

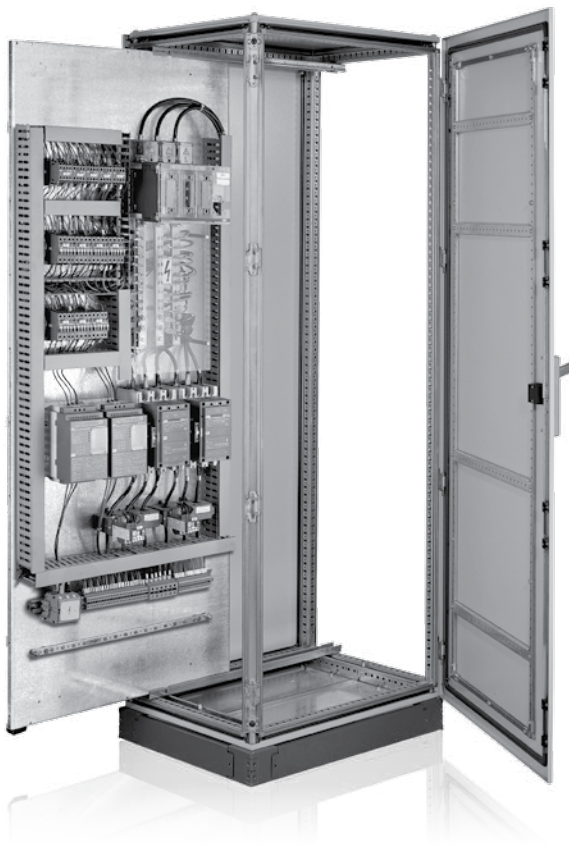

Choose flexibility

Whatever your PLC and I/O cards, ABB offers complete and pre-tested solutions adapted to your needs.

Interfast is a fast and error-free system.

The system is composed of three main parts:
 Front adaptors that simply plug into the I/O board
 Pre-wired and pre-tested cables available in different lengths and pluggable in a few seconds
 Passive and active interface modules that replace traditional terminal blocks.

Interfast offers pre-wired cables to connect with most of the PLCs existing on the market such as:

ABB
 Ge-Fanuc
 Mitsubishi
 Omron
 Rockwell
 Schneider
 Siemens.

Classic wiring

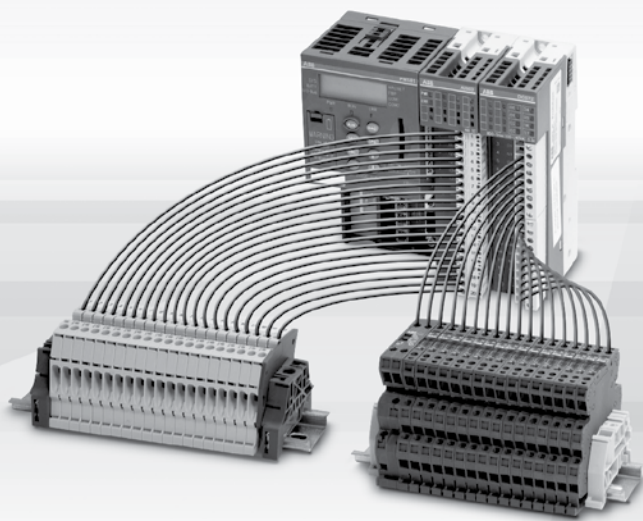

Interfast

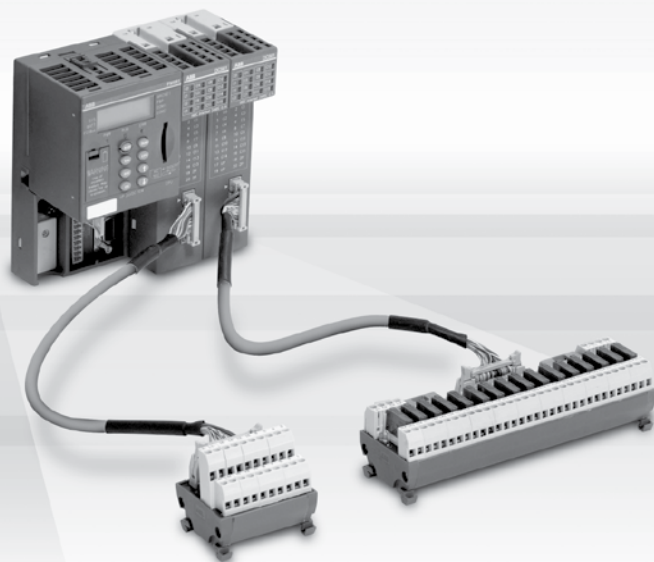

10

Your installation is flexible.

Thanks to our complete plug-and-play system, maintaining and replacing your installation has never been so easy.

Your wiring is reliable.

All our products are tested and wiring errors eliminated.

All your requirements are met

Find what you need in our wide range of interface modules
 From simple connecting modules to decoupling modules, many applications can be covered! Plus, with our Modular System, design your own interface modules according to your own needs.

Everything is clear in your cabinet

Installation is clear, cable strands can be located easily.

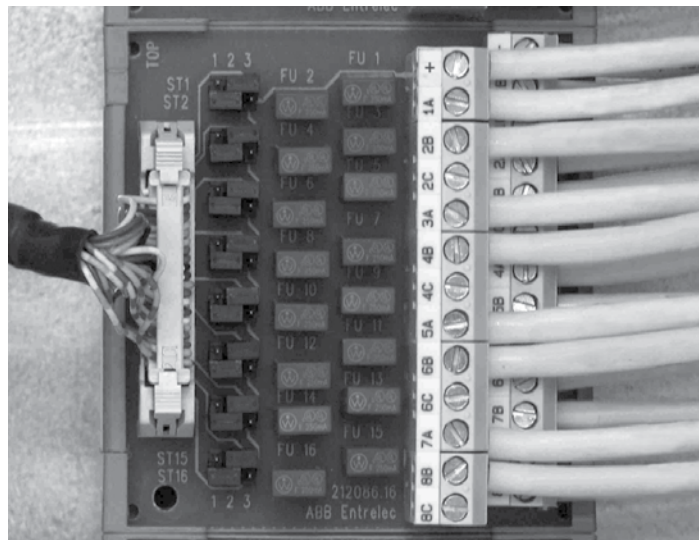

Interfast series

Connecting Interfast MS with omniconnect connector



Description	Without LED		With LED	
	16-channel	8-channel	16-channel	8-channel
Single wire	1SNA621017R1200	1SNA621016R1100		
Single wire redundancy	1SNA631005R2100	1SNA631004R2000	1SNA631007R2300	1SNA631006R2200
Single wire with fuse	1SNA631013R1000			
Two wire	1SNA631025R1400	1SNA631024R1300	1SNA631027R1600	1SNA631026R1500
Two, three or four wire	1SNA631055R2200	1SNA631054R2100	1SNA631061R2000	1SNA631060R0300
Interruptible single wire	1SNA631017R1400	1SNA631016R1300		
Interruptible two, three or four wire	1SNA631083R1700	1SNA631082R1600	1SNA631081R1500	1SNA631080R2000
Description	32-channel		32-channel	
Single wire	1SNA631001R2500		1SNA631003R2700	

Connecting Interfast PCB with HE10 connector



Description	Without LED		With LED	
	16-channel	8-channel	16-channel	8-channel
Single wire	1SNA020867R2000		1SNA020870R0700	
Two wire with fuse	1SNA020803R2100	1SNA020802R2000		
Two or three wire	1SNA020868R0100		1SNA020871R2400	
Three wire with fuse				1SNA020874R2700
Interruptible single wire	1SNA020869R0200		1SNA020872R2500	
Interruptible three wire with fuse			1SNA020873R2600	

Connecting Interfast PCB with omniconnect connector



Description	Without LED		With LED	
	16-channel	8-channel	16-channel	8-channel
Single wire	1SNA020859R0000		1SNA020863R2400	
Two or three wire	1SNA020860R0500		1SNA020864R2500	
Three wire with fuse	1SNA020861R2200	1SNA020857R2600	1SNA020865R2600	1SNA020858R0700
Interruptible single wire	1SNA020862R2300		1SNA020866R2700	

Decoupling Interfast MS with omniconnect connector



Description	16-channel	8-channel
N relay output interface 1SPDT without led	1SNA631124R1400	
N relay output interface 1SPDT	1SNA631125R1500	
N/P relay output interface 1SPDT	1SNA631181R1600	1SNA631182R1700
Universal interface without led	1SNA631151R2700	1SNA631158R0600
Universal interface with led on the power supply	1SNA631179R0300	1SNA631177R2100
Universal interface with led on the power supply and channels	1SNA631180R2100	1SNA631178R0200

Decoupling Interfast PCB with omniconnect or HE10 connector

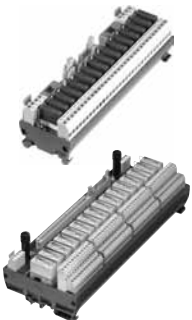

Description	16 relays with HE10	16 relays with omniconnect and HE10	8 relays with omniconnect
N/P relay output interface 1NO	1SNA020954R2700	1SNA021080R1000 only omniconnect	
N/P relay output interface 1NO for solenoid valve control		1SNA020836R1100	1SNA020830R2700
N/P relay output interface 1NO with fuse on common contact	1SNA020800R0200		
N/P relay output interface 1SPDT		1SNA020831R1400	1SNA020826R1700
N/P relay output interface 1SPDT compact	1SNA020953R2600		
N/P relay output interface 1SPDT with fuse on common contact		1SNA020833R1600	1SNA020828R2100
N/P relay output interface 1SPDT with interruptible terminal		1SNA020835R1000	1SNA020829R2200
N/P relay output interface 1SPDT with coil override		1SNA020834R1700	
N/P relay output interface 1DPDT		1SNA020832R1500	1SNA020827R1000
N/P relay input interface 1NO	1SNA020955R2000		
N/P relay input interface 1NO with fuse on common contact	1SNA020856R2500		

Tools ready to use and ready to "click"

Learn more about Interfast on the web from the ABB eMedia portal.

<http://www.web-emedial.com/interfast>

This library gives you access to all the latest eCat documentation for the whole range, online, anytime.

Our selection tool helps you to easily define a solution that suits your application.

The image displays a sequence of screenshots from the Interfast selection tool. The first screenshot shows the 'Interfast' product overview with a 'Concept' diagram and 'Product Offer' section. The second screenshot shows the 'Selection guide' interface with a blue arrow pointing to the '2' step. The third screenshot shows the 'Select the PLC module' step with a blue arrow pointing to the '3' step. The final, largest screenshot shows the 'Selection Guide' configuration screen with the following details:

1 Select the PLC module
 Manufacturer: ABB | PLC: S500 | Module Part Number: A0801

2 Select the function

Technology	Description	Lead	Order code	Association	Micro-ITC
Interfast MS	Single-wire interface	No	1SN4431017R1200	Power	656
Interfast MS	Single-wire and busbar interface	No	1SN4431019E1000	Power	656
Interfast MS	Single-wire interface with fuse	No	1SN4431013R1000	Power	656
Interfast MS	Two-wire interface	No	1SN4431025R1400	Power	656
Interfast MS	Two, three or four-wire interface	No	1SN4431055R2200	Power	656
Interfast MS	Interchangeable single-wire interface	No	1SN4431017R1400	Power	656

3 Select the cable
 Standard: IEC | Cable length (mm): 1

Your PLC pre-wiring system

Interface
 Order code: 1SN443100R2100
 Description: IEC616-1
 Technology: PLC-Connector Interface Interfast MS
 With Lead: No
 Qty: 1

Cable
 Order code: 1SN443000R1000
 Description: LAF1000K08C0696
 Standard: IEC
 Length (m): 1
 Qty: 1

Front adaptor
 Order code:
 Description: Qty

PDFs: Catalogue page, Picture (eps), Picture (png), Download

10

Interfast catalog



Interfast:
the PLC pre-wiring system
Interface modules
catalog reference
No. 1SNC127006C0202

Additional Interfast products

This Interfast section represents just a portion of the ABB Interfast product offering. For the complete offering please visit our website at www.web-emedial.com/interfast

Notes