

Product Overview

The QPA9908 is a high-efficiency, linearizable power amplifier targeting Band 8 small-cell wireless infrastructure systems. The product delivers high efficiency of 36% at +28dBm average output power, while providing excellent DPD linearized ACPR of -48dBc for signal bandwidths of up to 40MHz.

The QPA9908 is housed in a 5x5mm SMT package. It is pin-to-pin compatible to QPA9903 (band 3 high-efficiency small cell PA).

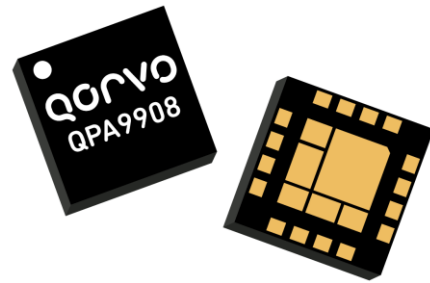

16 Pad 5 x 5 mm Package

Functional Block Diagram

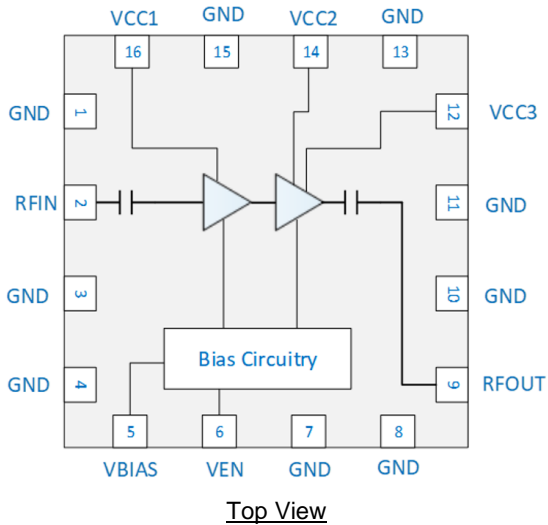

Key Features

- 850 – 960 MHz
- Up to 40MHz IBW capability
- 32.6 dB Gain typical
- 36% PAE at +28 dBm power output
- <-48 dBc ACPR DPD linearized at +28 dBm Pout
- 1.8V logic compatible PA ON/OFF control
- On chip ESD protection

Applications

- 3GPP Band 8 Small Cells
- M-MIMO
- Repeaters / DAS
- Mobile Infrastructure
- General Purpose Wireless

Ordering Information

Part No.	Description
QPA9908TR13	2500 on reel
QPA9908EV01	850-960 MHz EVB

Absolute Maximum Ratings

Parameter	Rating
Storage Temperature	-55 to +125 °C
RF Input Power, Pulsed CW, 50 Ω ⁽¹⁾	+10 dBm
Device Voltage (V _{CC})	+5.5 V

Exceeding any one or a combination of the Absolute Maximum Rating conditions may cause permanent damage to the device. Extended application of Absolute Maximum Rating conditions to the device may reduce device reliability.

Note:

1. 850-960 MHz, Pulsed CW, 10% duty cycle, 100us period

Recommended Operating Conditions

Parameter	Min	Typ	Max	Units
Device Voltage (V _{CC})	+4.75	+5	+5.25	V
T _{CASE}	-40		+85	°C
T _j for >10 ⁶ hours MTTF			+175	°C

Electrical specifications are measured at specified test conditions. Specifications are not guaranteed over all recommended operating conditions.

Electrical Specifications

Parameter	Conditions ⁽¹⁾	Min	Typ	Max	Units
Operational Frequency Range		850		960	MHz
Test Frequency			942		MHz
Gain	Pout = +28 dBm	30	32.6		dB
Input Return Loss			-20		dB
Output P3dB	100 μs/1 ms, 10% duty cycle	+33	+35.5		dBm
Power Added Efficiency ⁽²⁾	Pout = +28 dBm		36		%
ACPR(Uncorrected) ⁽³⁾	Pout = +28 dBm		-32		dBc
Quiescent Current, I _{CC}	Pins 12, 14 and 16	40	70	100	mA
Total Operating Current	Pins 5, 12, 14 and 16, Pout = +28 dBm		370		mA
Thermal Resistance, θ _{JC}	Junction to case		24		°C/W
V _{EN} High		1.17	1.8	V _{CC}	V
V _{EN} Low		0	0	0.63	V
2nd Harmonic	Pout = +28 dBm		-40		dBc
3rd Harmonic	Pout = +28 dBm		-50		dBc

Notes:

1. Test conditions unless otherwise noted: All V_{CC} & V_{BIAS} = +5.0 V, V_{EN} = +1.8 V, Temp = +25 °C, 50 Ω system.
2. LTE, 20 MHz E-UTRA Test Model 1.1 or 3.1, PAR = 8.5 dB at 0.01% Probability
3. LTE, 20 MHz x 2 E-UTRA Test Model 1.1 or 3.1, PAR = 8.5 dB at 0.01% Probability

Power Amplifier Enable Logic Table

Parameter	High	Low
V _{EN}	Power Amplifier ON	Power Amplifier OFF

850–960 MHz Evaluation Board

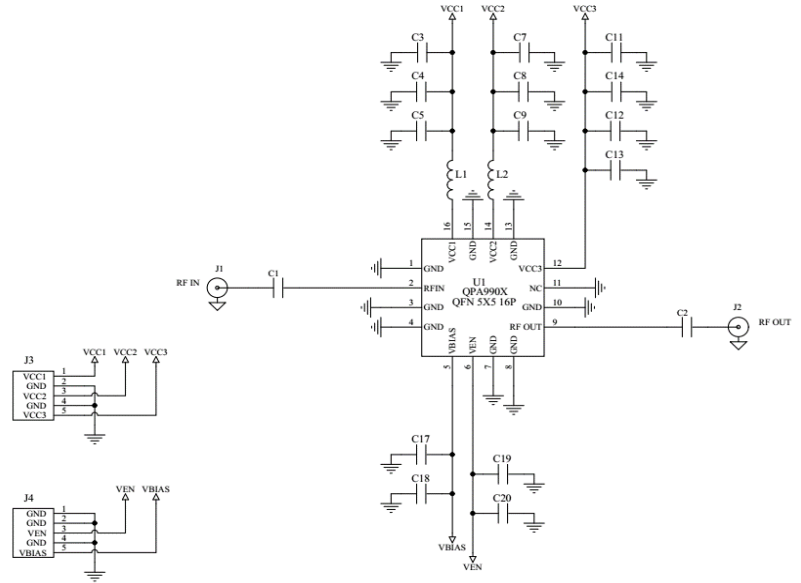
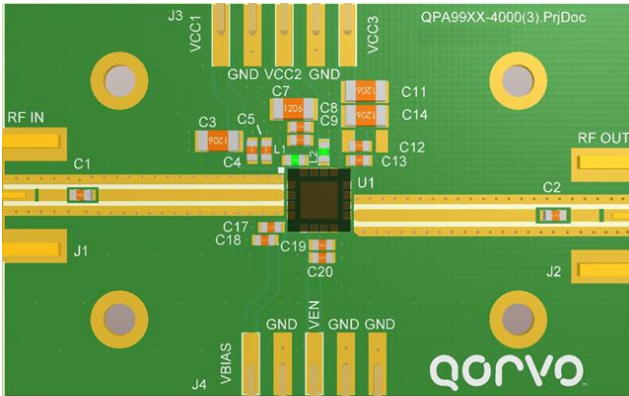

- Notes:
1. See Evaluation Board PCB Information for material and stack up.

Bill of Material – QPA9908EVB01

Reference Des.	Value	Description	Manuf.	Part Number
U1	-	Amplifier, QPA9908 850-960MHz, High-Efficiency	Qorvo	QPA9908
C1, C2	100 pF	CAP,100 pF, 0603, 5%, 50V, NPO	various	
C5, C9, C13, C17, C19	1000 pF	CAP,1000 pF, 0603, 5%, 50V, NPO	various	
C4, C8, C12, C18, C20	0.1 μF	CAP,0.1 μF, 0603, 10%, 50V, X7R	various	
C3, C7, C14	10 μF	CAP, 10 μF, 1206, 16V	various	
L1, L2	0 Ω	RES 0 Ω, 0603, 1/16W, Chip	various	

Performance Plots – LTE

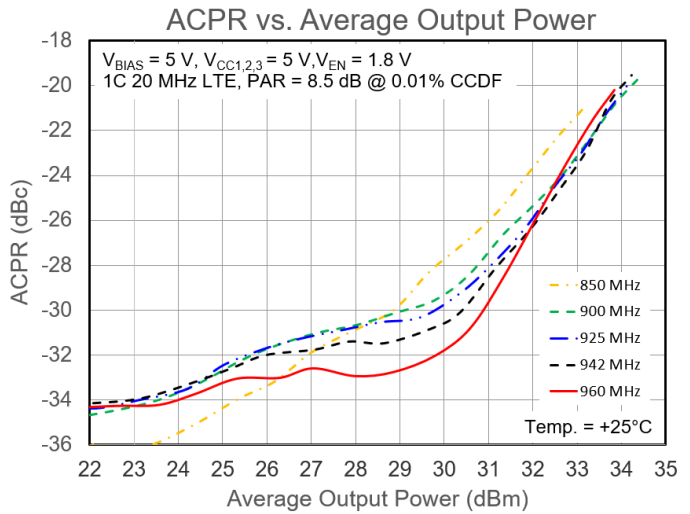
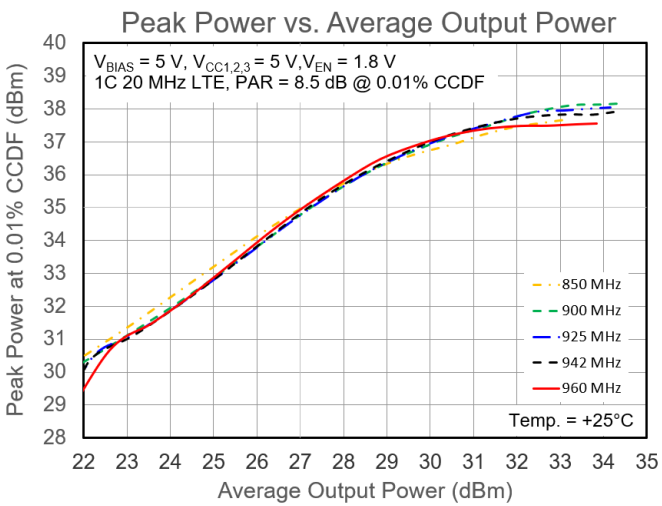
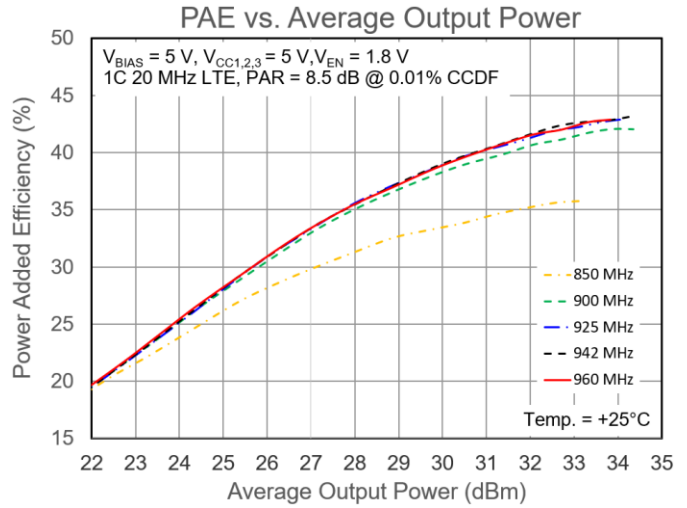
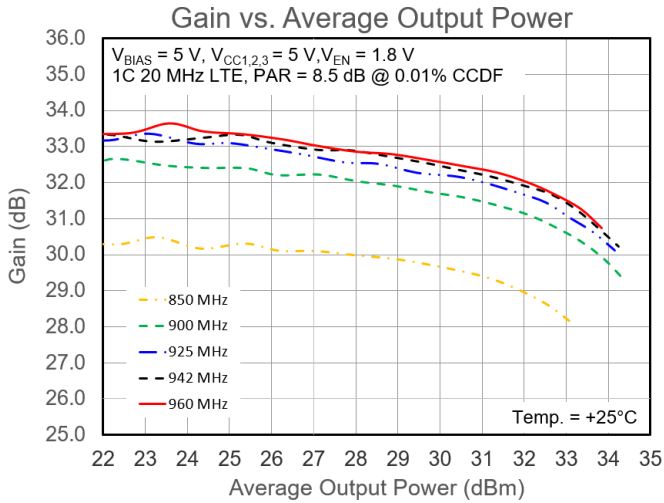

Test conditions unless otherwise noted: $V_{BIAS} = 5\text{ V}, V_{CC1,2,3} = 5\text{ V}, V_{EN} = 1.8\text{ V}, T = +25^\circ\text{C}$, tested using a single-carrier, 20 MHz LTE signal with 8.5 dB PAR at 0.01% CCDF on a reference design fixture.

Performance Plots – LTE

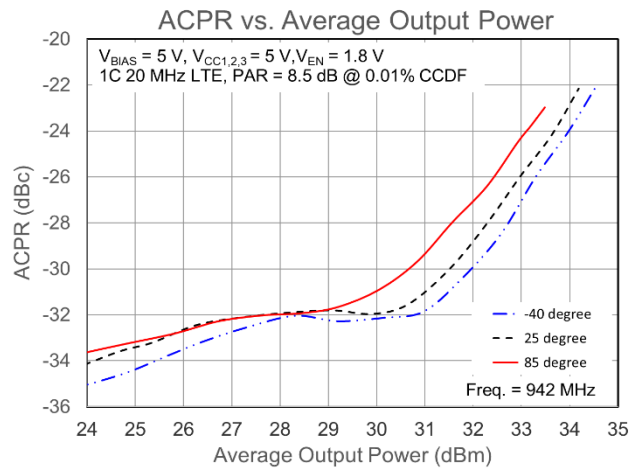
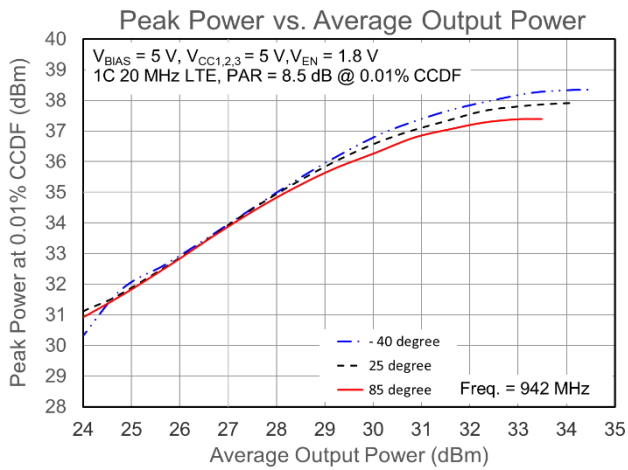
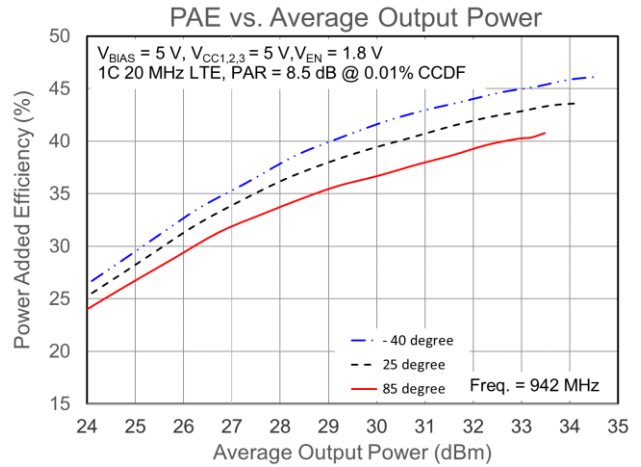
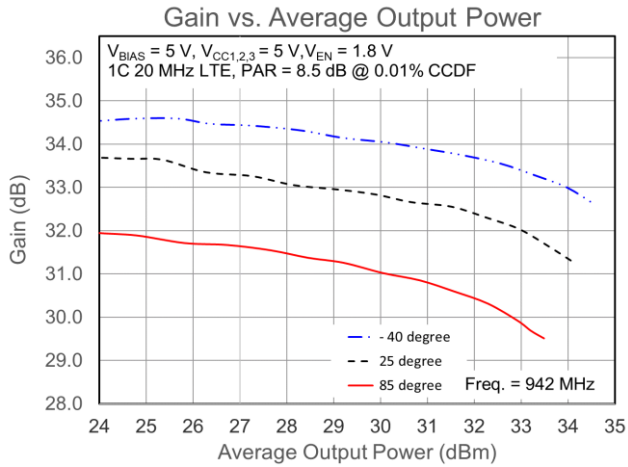

Test conditions unless otherwise noted: $V_{BIAS} = 5V$, $V_{CC1,2,3} = 5V$, $V_{EN} = 1.8V$, tested at 942 MHz using a single-carrier, 20 MHz LTE signal with 8.5 dB PAR at 0.01% CCDF on a reference design fixture.

Performance Plots – Pulsed Signal Measurements

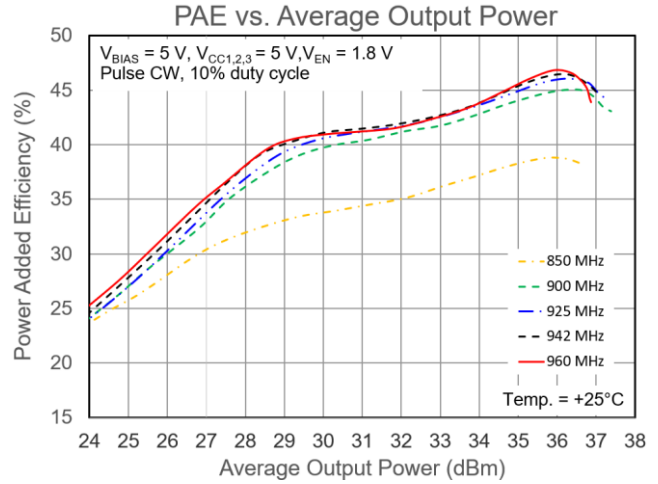
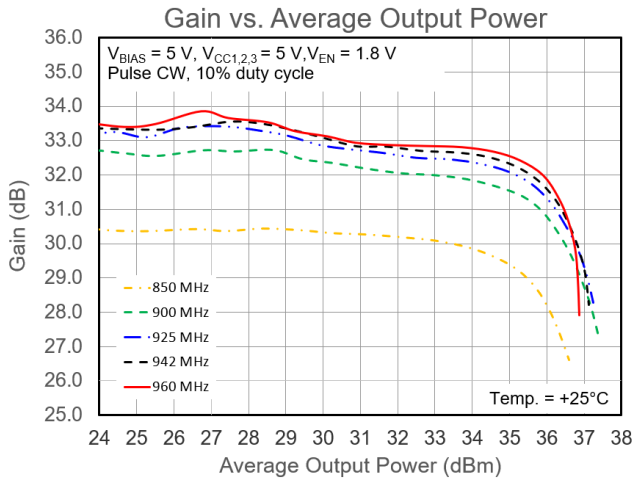

Test conditions unless otherwise noted: $V_{BIAS} = 5\text{ V}, V_{CC1,2,3} = 5\text{ V}, V_{EN} = 1.8\text{ V}, T = +25^\circ\text{C}$, tested using a pulse signal, 10% duty cycle.

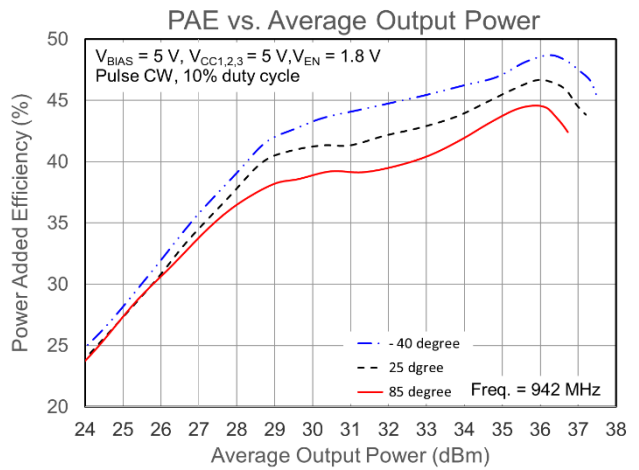
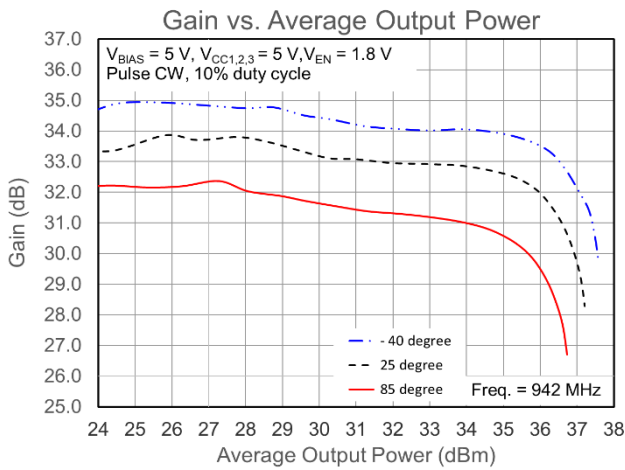

Test conditions unless otherwise noted: $V_{BIAS} = 5\text{ V}, V_{CC1,2,3} = 5\text{ V}, V_{EN} = 1.8\text{ V}$, tested at 942 MHz using a pulse signal, 10% duty cycle.

Performance Plots – S-parameter

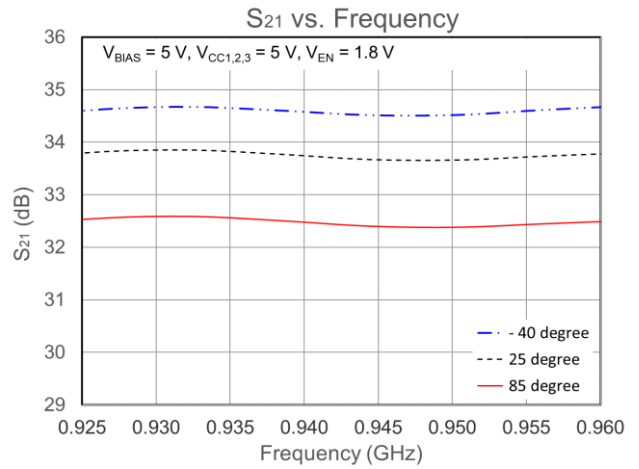
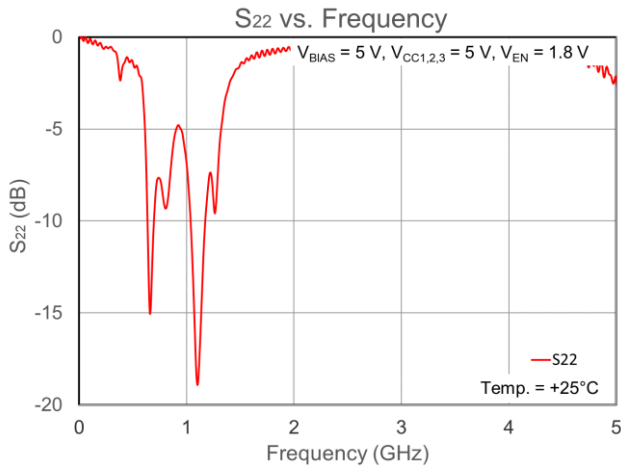
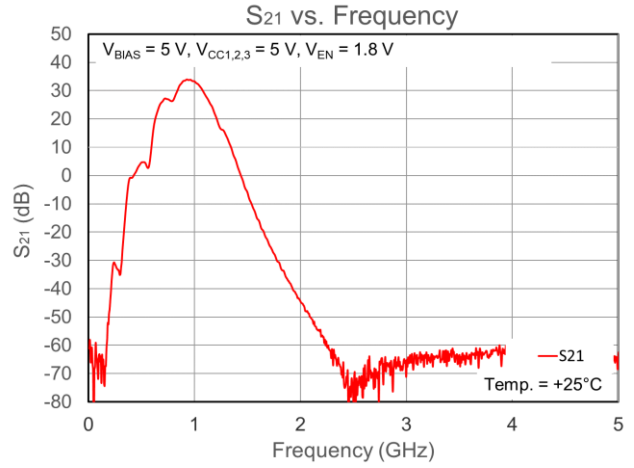
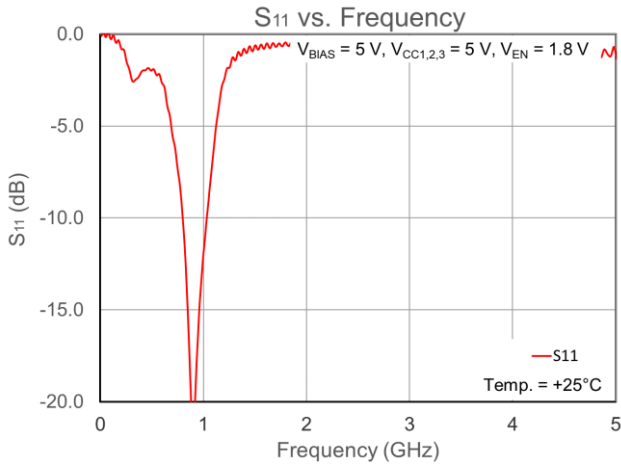

Test conditions unless otherwise noted: $V_{BIAS} = 5\text{ V}, V_{CC1,2,3} = 5\text{ V}, V_{EN} = 1.8\text{ V}$.

Pad Configuration and Description

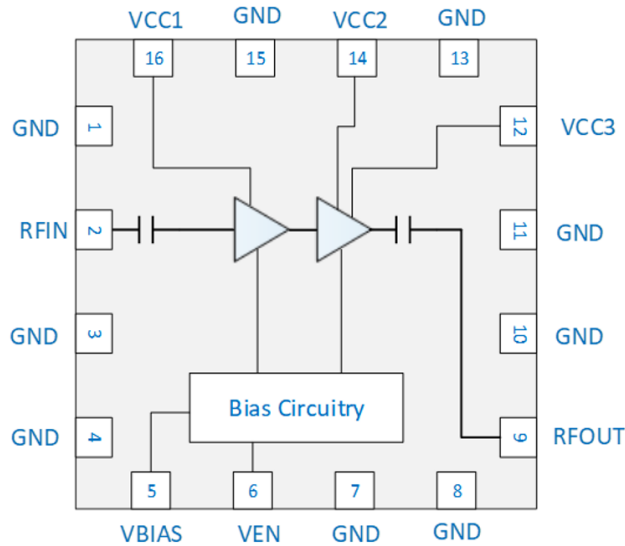

Top View

Pad No.	Label	Description
1, 3, 4, 7, 8, 10, 11, 13, 15	GND	Ground connection.
2	RF _{IN}	RF input, internally matched to 50Ω.
5	V _{BIAS}	Bias circuit supply voltage
6	V _{EN}	Amplifier enable voltage (regulated internally)
9	RF _{OUT}	RF output, internally matched to 50Ω. It has low impedance at DC. An external series capacitor is required if high impedance is needed at DC.
12	V _{CC3}	Supply voltage for the various amplifier stages
14	V _{CC2}	Supply voltage for the various amplifier stages
16	V _{CC1}	Driver stage supply voltage
Backside Paddle	GND	Ground connection. The back side of the package should be connected to the ground plan though as short of a connection as possible. PCB via holes under the device are recommended.

Package Marking and Dimensions

Marking: Pin 1 Indicator and Qorvo Logo

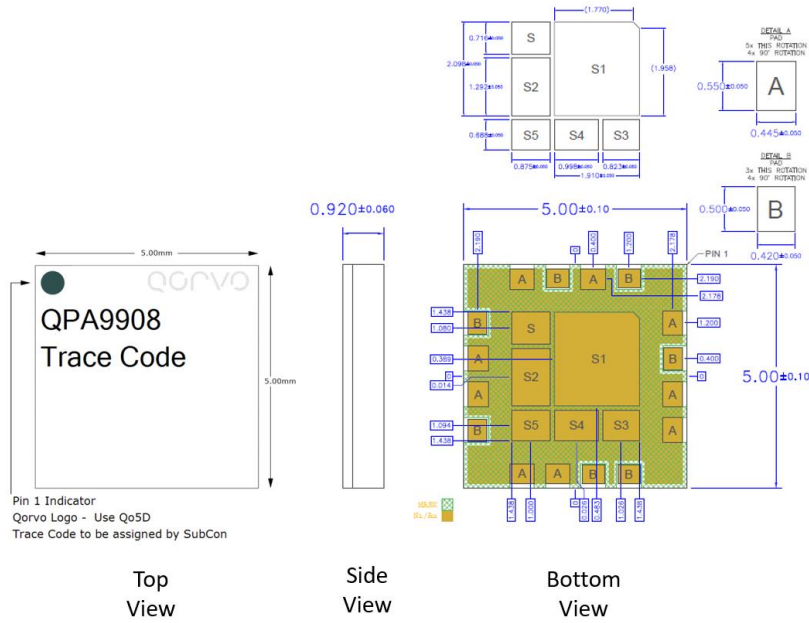

Notes:

1. All dimensions are in millimeters. Angles are in degrees.
2. The terminal #1 identifier and terminal numbering conform to JESD 95-1 SPP-012.
3. Contact plating: ENEPIG (Electroless Nickel Electroless Palladium Immersion Gold)

PCB Mounting Pattern

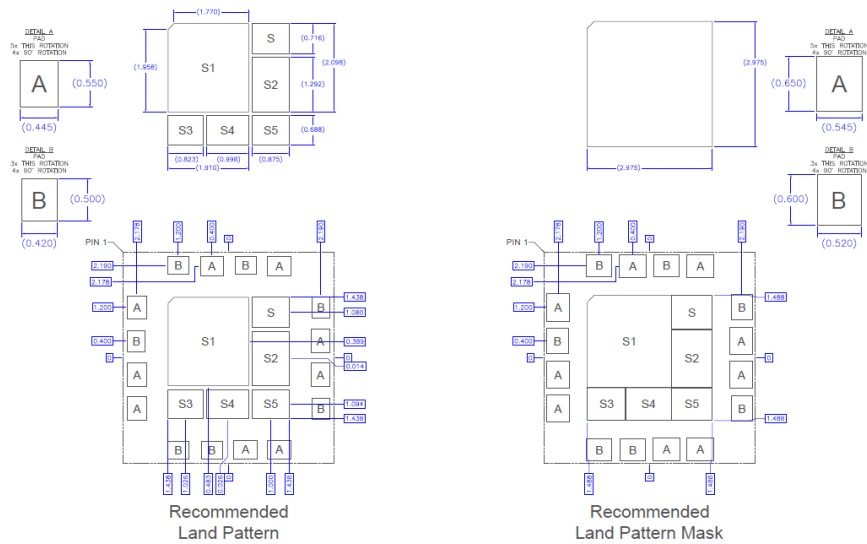

Evaluation Board PCB Information

PC Board Layout

PCB Material (stackup)

Layer	Name	Material	Thickness	Constant
1	Top Overlay			
2	Top Solder	Solder Resist	0.40 mil	3.5
3	Top Layer	Copper	1.40 mil	
4	Dielectric1	RO4350	20.00 mil	3.48
5	Bottom Layer	Copper	1.40 mil	

Total thickness: 23.2mil

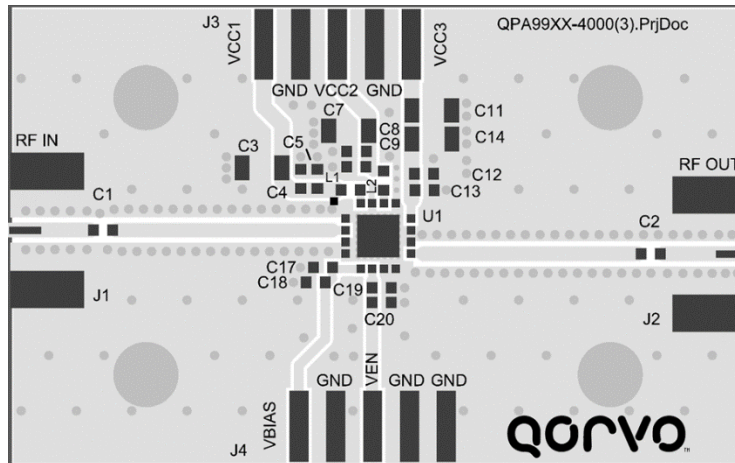

Notes:

1. All dimensions are in millimeters. Angles are in degrees.
2. Use 1 oz. copper minimum for top and bottom layer metal.
3. Via holes are required under the backside paddle of this device for proper RF/DC grounding and thermal dissipation. We recommend a 0.35mm (#80/.0135") diameter bit for drilling via holes and a final plated thru diameter of 0.25 mm (0.10").
4. Ensure good package backside paddle solder attach for reliable operation and best electrical performance.

Tape and Reel Information – Carrier and Cover Tape Dimensions

Tape and reel specifications for this part are also available on the Qorvo website.
 Standard T/R size = 2500 pieces on a 13" reel.

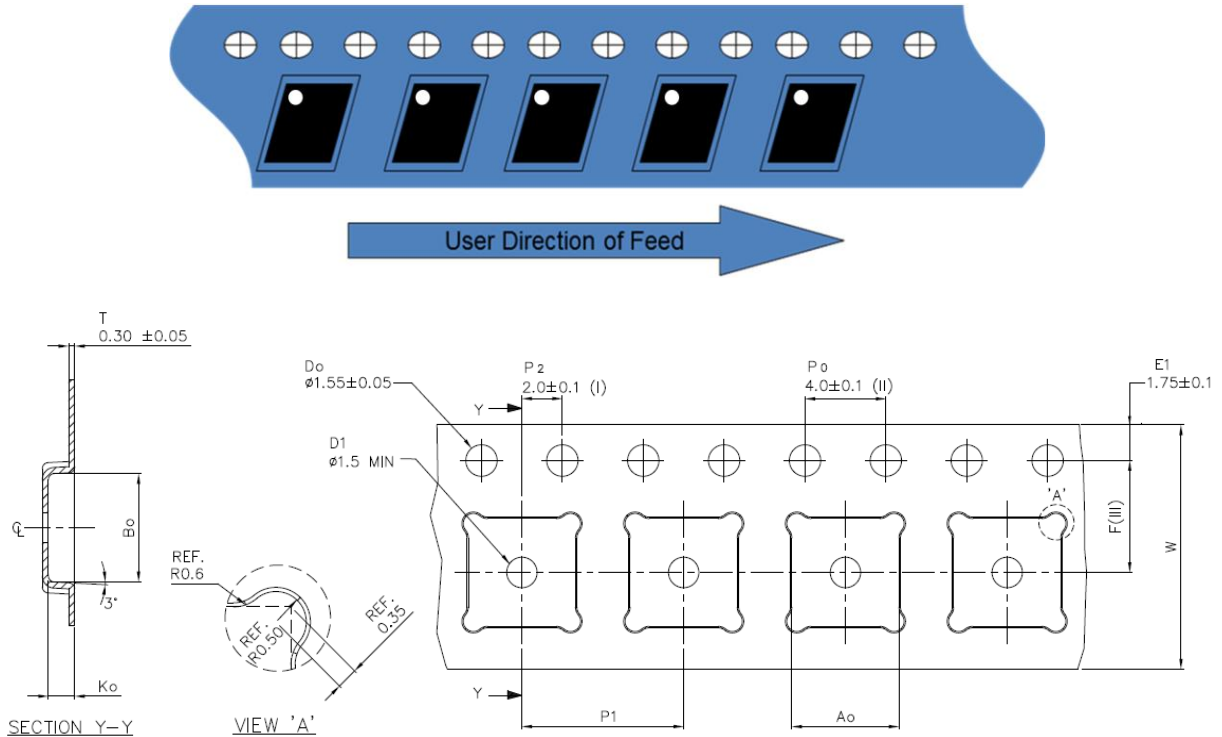

Feature	Measure	Symbol	Size (in)	Size (mm)
Cavity	Length	A0	0.209	5.3
	Width	B0	0.209	5.3
	Depth	K0	0.051	1.3
	Pitch	P1	0.315	8.0
Centerline Distance	Cavity to Perforation - Length Direction	P2	0.079	2.0
	Cavity to Perforation - Width Direction	F	0.217	5.5
Cover Tape	Width	C	0.362	9.2
Carrier Tape	Width	W	0.472	12

Tape and Reel Information – Reel Dimensions

Packaging reels are used to prevent damage to devices during shipping and storage, loaded carrier tape is typically wound onto a plastic take-up reel. The reel size is 13" diameter. The reels are made from high-impact injection-molded polystyrene (HIPS), which offers mechanical and ESD protection to packaged devices.

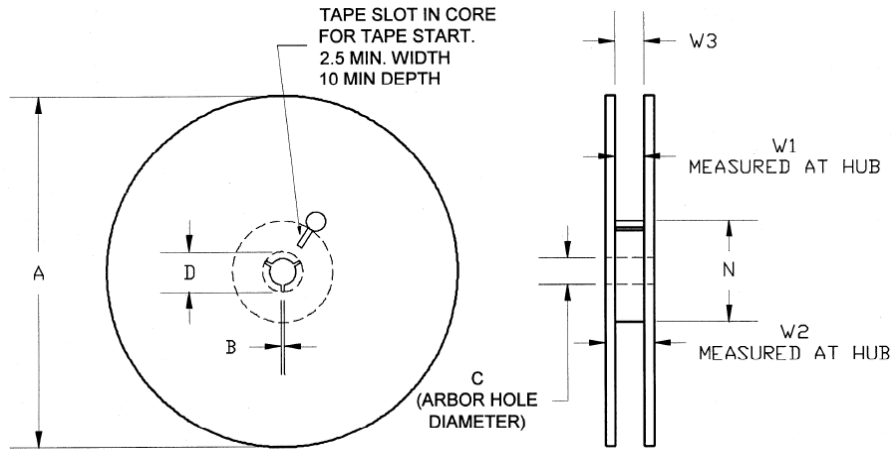

Feature	Measure	Symbol	Size (in)	Size (mm)
Flange	Diameter	A	12.992	330.00
	Thickness	W2	0.717	18.20
	Space Between Flange	W1	0.504	12.80
Hub	Outer Diameter	N	4.016	102.00
	Arbor Hole Diameter	C	0.512	13.00
	Key Slit Width	B	0.079	2.00
	Key Slit Diameter	D	0.795	20.2

Tape and Reel Information – Tape Length and Label Placement

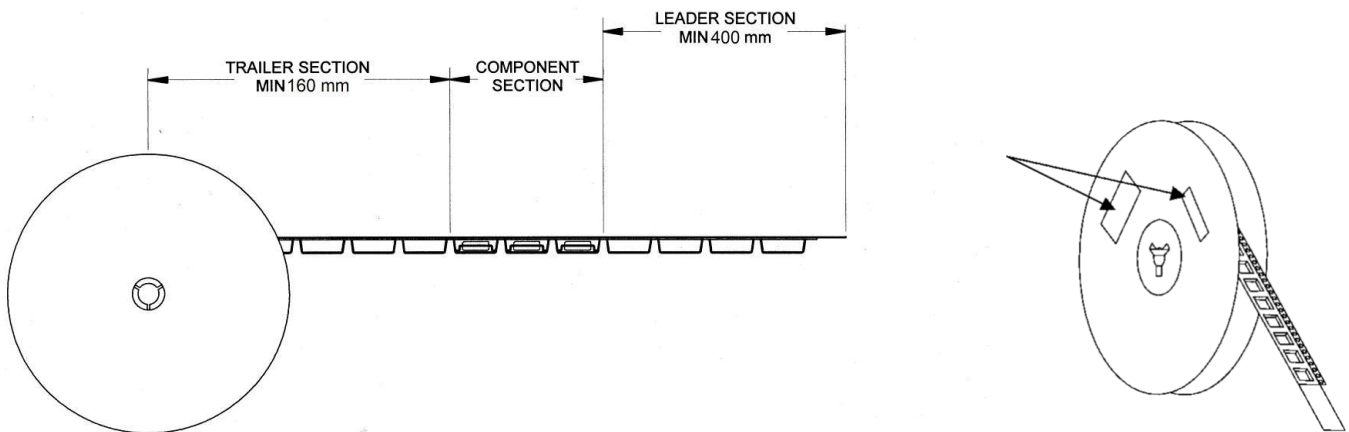

- Notes:
1. Empty part cavities at the trailing and leading ends are sealed with cover tape. See EIA 481.
 2. Labels are placed on the flange opposite the sprockets in the carrier tape.

Recommended Solder Temperature Profile

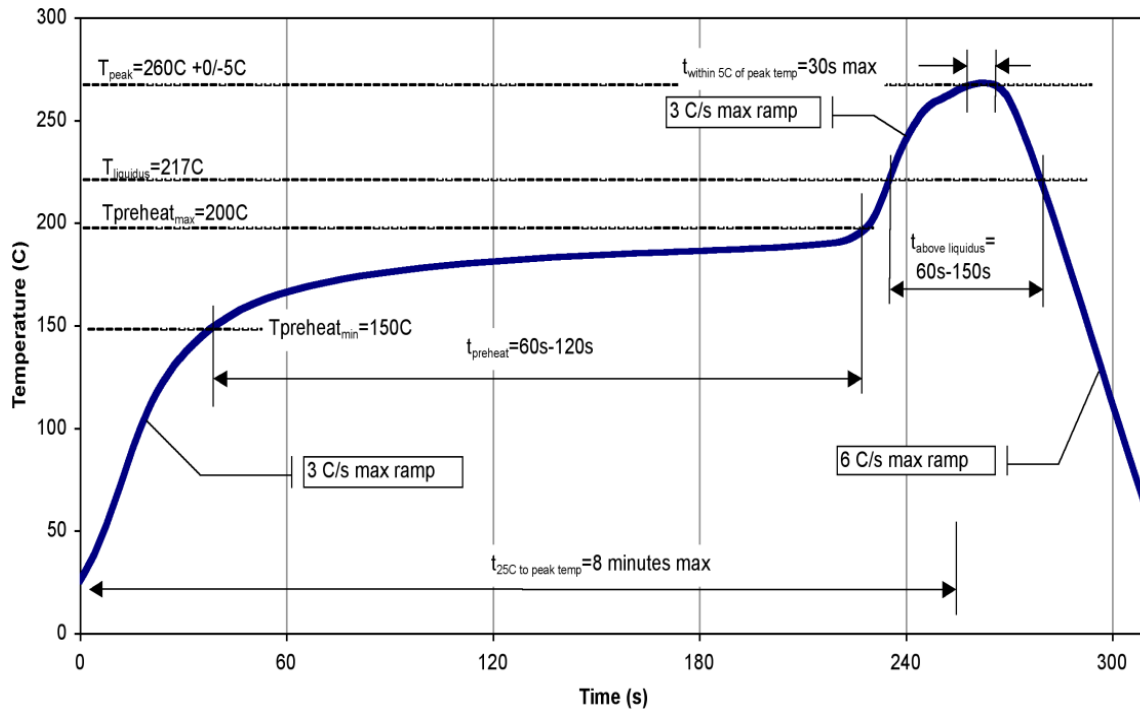

Handling Precautions

Parameter	Rating	Standard
ESD – Human Body Model (HBM)	1C	ESDA / JEDEC JS-001-2012
ESD – Charged Device Model (CDM)	C3	JEDEC JESD22-C101F
MSL – Moisture Sensitivity Level	3	IPC/JEDEC J-STD-020



Caution!
ESD-Sensitive Device

Solderability

Compatible with both lead-free (260°C max. reflow temp.) and tin/lead (245°C max. reflow temp.) soldering processes. Solder profiles available upon request.

Contact plating: ENEPIG (Electroless Nickel Electroless Palladium Immersion Gold)

RoHS Compliance

This part is compliant with 2011/65/EU RoHS directive (Restrictions on the Use of Certain Hazardous Substances in Electrical and Electronic Equipment) as amended by Directive 2015/863/EU.

This product also has the following attributes:

- Product uses RoHS Exemption 7c-I to meet RoHS Compliance requirements.
- Halogen Free (Chlorine, Bromine)
- Antimony Free
- TBBP-A (C15H12Br4O2) Free
- PFOS Free
- SVHC Free

Contact Information

For the latest specifications, additional product information, worldwide sales and distribution locations:

Web: www.qorvo.com

Tel: 1-844-890-8163

Email: customer.support@qorvo.com

For technical questions and application information:

Email: appsupport@qorvo.com

Important Notice

The information contained herein is believed to be reliable; however, Qorvo makes no warranties regarding the information contained herein and assumes no responsibility or liability whatsoever for the use of the information contained herein. All information contained herein is subject to change without notice. Customers should obtain and verify the latest relevant information before placing orders for Qorvo products. The information contained herein or any use of such information does not grant, explicitly or implicitly, to any party any patent rights, licenses, or any other intellectual property rights, whether with regard to such information itself or anything described by such information. **THIS INFORMATION DOES NOT CONSTITUTE A WARRANTY WITH RESPECT TO THE PRODUCTS DESCRIBED HEREIN, AND QORVO HEREBY DISCLAIMS ANY AND ALL WARRANTIES WITH RESPECT TO SUCH PRODUCTS WHETHER EXPRESS OR IMPLIED BY LAW, COURSE OF DEALING, COURSE OF PERFORMANCE, USAGE OF TRADE OR OTHERWISE, INCLUDING THE IMPLIED WARRANTIES OF MERCHANTABILITY AND FITNESS FOR A PARTICULAR PURPOSE.**

Without limiting the generality of the foregoing, Qorvo products are not warranted or authorized for use as critical components in medical, life-saving, or life-sustaining applications, or other applications where a failure would reasonably be expected to cause severe personal injury or death.

Copyright 2021 © Qorvo, Inc. | Qorvo is a registered trademark of Qorvo, Inc.

Mouser Electronics

Authorized Distributor

Click to View Pricing, Inventory, Delivery & Lifecycle Information:

[Qorvo:](#)

[QPA9908TR13](#) [QPA9908EVB01](#) [QPA9908SR](#)