

### General Description

Qorvo's QPA2735 is a packaged, high-performance, low noise amplifier fabricated on Qorvo's production 90nm pHEMT (QPHT09) process. Covering 13 – 20 GHz, the QPA2735 provides 25.5 dB small signal gain and P1dB of 18 dBm, while supporting a noise figure of 1.3 dB and IM3 levels of -60 dBc (at Pout=0 dBm/tone).

Packaged in a small 4 mm x 4 mm plastic overmold QFN, the QPA2735 is matched to 50 ohms with integrated DC blocking caps on both I/O ports for easy handling and simple system integration.

The QPA2735 high performance and ease of handling makes it ideal for satellite and point to point communication systems.

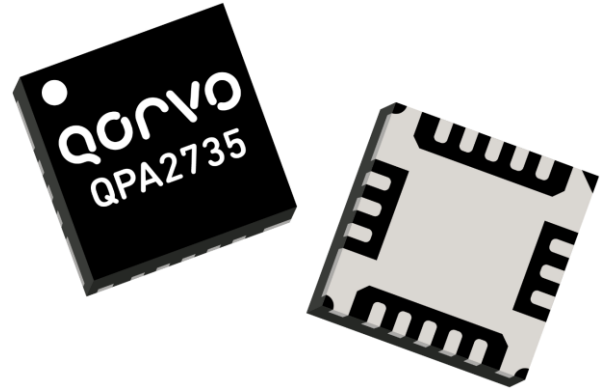

### Product Features

- Frequency Range: 13 – 20 GHz
- Noise Figure: 1.3 dB
- Small Signal Gain: 25.5 dB
- Power at 1 dB Compression: 18 dBm
- Saturation Power: 23 dBm
- IMD3: -60 dBc (@ Pout = 0 dBm/tone)
- Bias: VD = 3.5 V, IDQ = 105 mA, VG = -0.46 V
- Plastic Over-mold Package
- Package Dimensions: 4.0 x 4.0 x 0.85 mm

*Performance is typical across frequency.  
Please reference electrical specification table and data plots for more details.*

### Applications

- Satellite Communications
- Point to Point Communications

### Functional Block Diagram

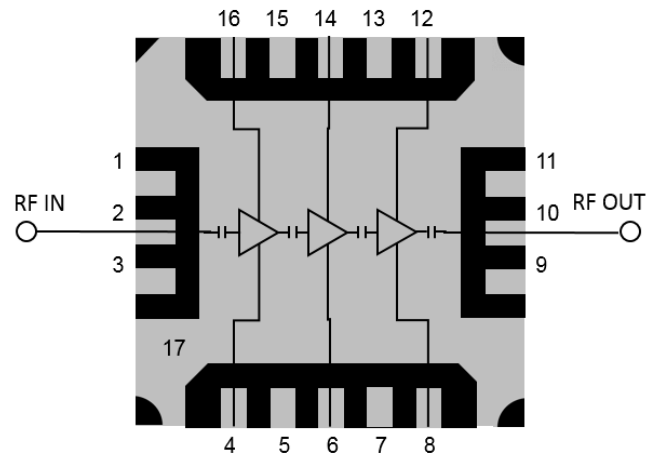

### Ordering Information

Part No.	Description
QPA2735TR7X	QPA2735 Tape and Reel 7", Qty 50
QPA2735TR7	QPA2735 Tape and Reel 7", Qty 750
QPA2735EVB1	QPA2735 LNA Evaluation Board, Qty 1

## Absolute Maximum Ratings

Parameter	Value	Units
Drain Voltage (VD)	4.5	V
Drain Current (ID1/ID2/ID3)	96/90/192	mA
Gate Voltage Range	-1.3 to 0	V
Gate Current (IG1/IG2/IG3 at 125 °C)	5.0/5.0/6.6	mA
RF Input Power (50 Ω, 85 °C)	20	dBm
Channel Temperature, T <sub>CH</sub>	175	°C
Mounting Temperature (30 seconds)	260	°C
Storage Temperature	- 55 to 150	°C

Operation of this device outside the parameter ranges given above may cause permanent damage. These are stress ratings only, and functional operation of the device at these conditions is not implied. Extended application of Absolute Maximum Rating conditions may reduce device reliability.

## Recommended Operating Conditions

Parameter	Value	Units
Drain Voltage	3.5	V
Drain Current (quiescent, IDQ)	105	mA
Gate Voltage (typical)	-0.46	V
Operating Temperature Range	-40 to 85	°C

Electrical specifications are measured at specified test conditions. Specifications are not guaranteed over all recommended operating conditions.

## Electrical Specifications

Test conditions, unless otherwise noted: VD = 3.5 V, IDQ = 105 mA, 25 °C. Data de-embedded to device reference planes.

Parameter	Min	Typical	Max	Units
Frequency	13		20	GHz
Small Signal Gain		25.5		dB
Noise Figure		1.3		dB
Power 1- dB Compression Point		18		dBm
Input Return Loss		12		dB
Output Return Loss		15		dB
3 <sup>RD</sup> Order Intermodulation level (Pout= 0 dBm / tone)		-60		dBc
Output TOI (Pout= 0 dBm / tone)		30		dBm
Gain Temperature Coefficient		-0.013		dB/°C

Performance Plots – Small Signal

Test Conditions unless otherwise stated:  $V_D = 3.5\text{ V}$ ,  $I_{DQ} = 105\text{ mA}$ ,  $25\text{ }^\circ\text{C}$

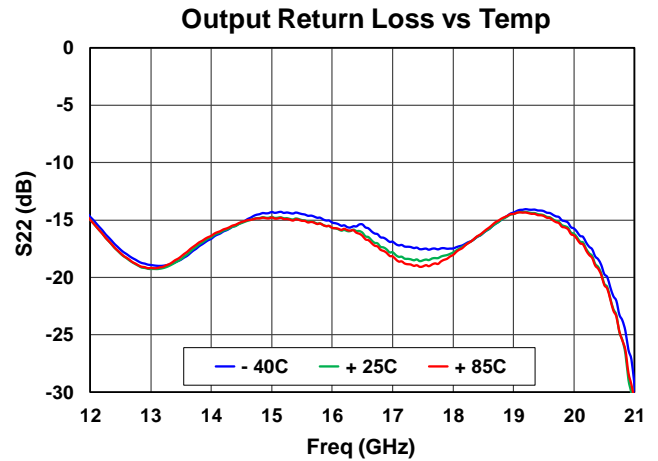
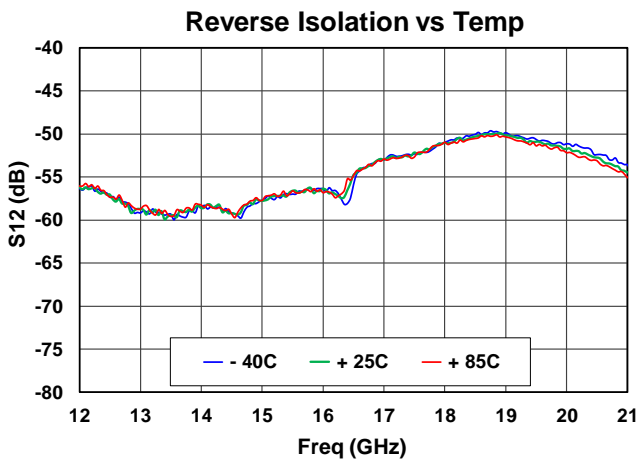
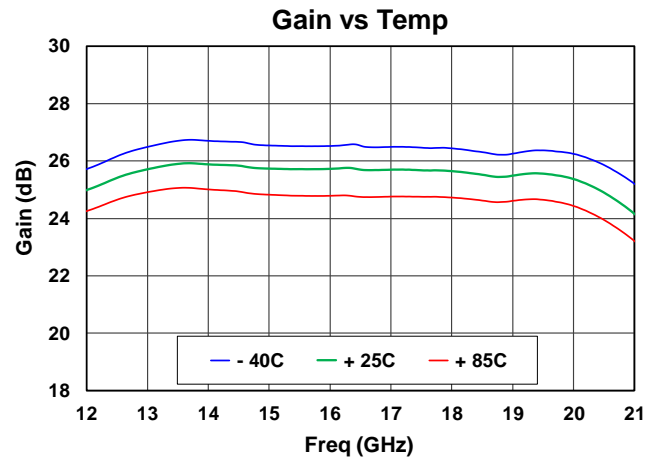
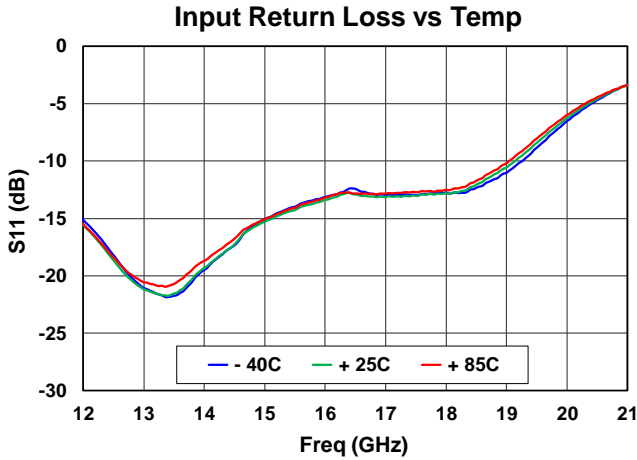

Performance Plots – Small Signal

Test Conditions unless otherwise stated:  $V_D = 3.5\text{ V}$ ,  $I_{DQ} = 105\text{ mA}$ ,  $25\text{ }^\circ\text{C}$

Gain vs Voltage

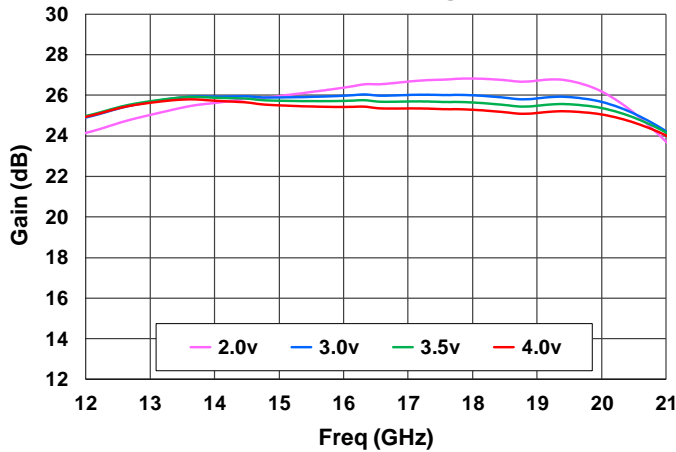

Gain vs Current

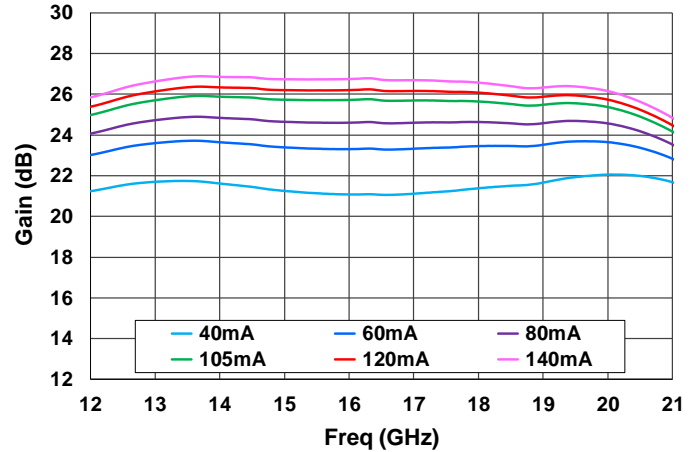

Input Return Loss vs Voltage

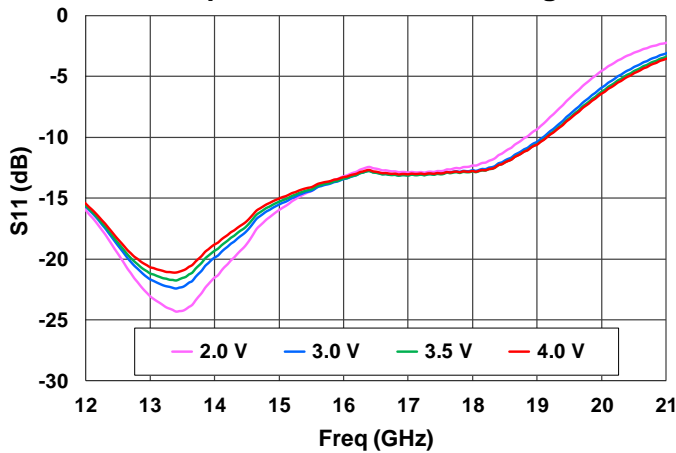

Input Return Loss vs Current

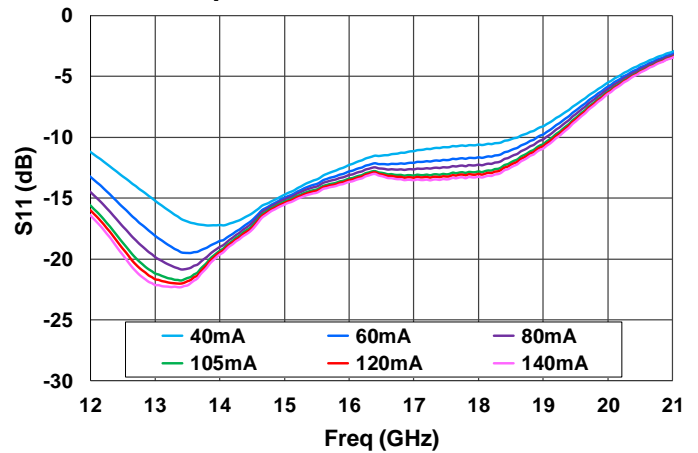

Output Return Loss vs Voltage

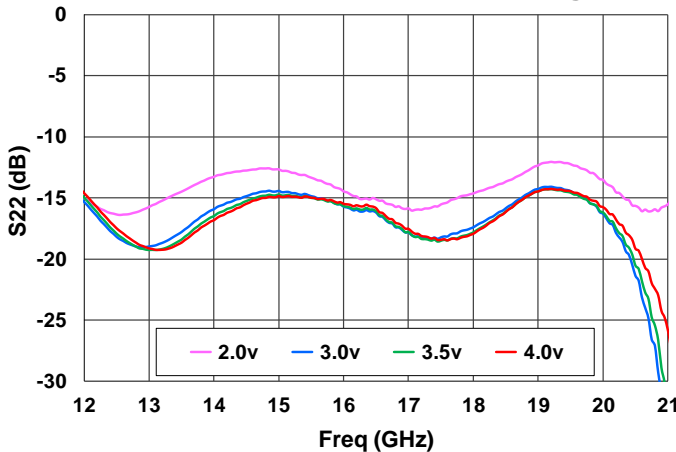

Output Return Loss vs Current

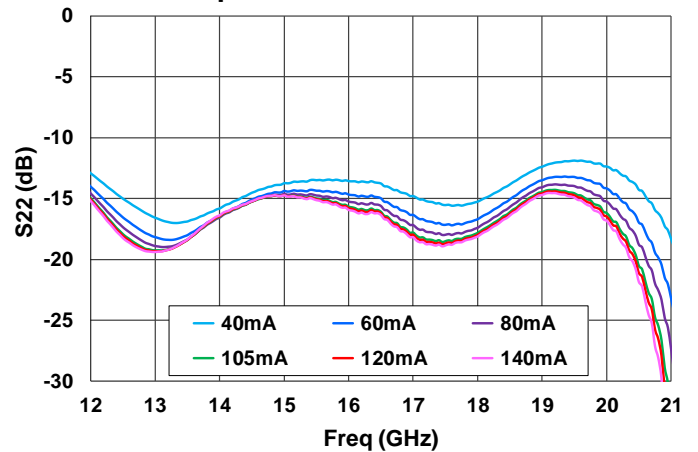

Performance Plots – Noise Figure

Test Conditions unless otherwise stated:  $V_D = 3.5\text{ V}$ ,  $I_{DQ} = 105\text{ mA}$ ,  $25\text{ }^\circ\text{C}$

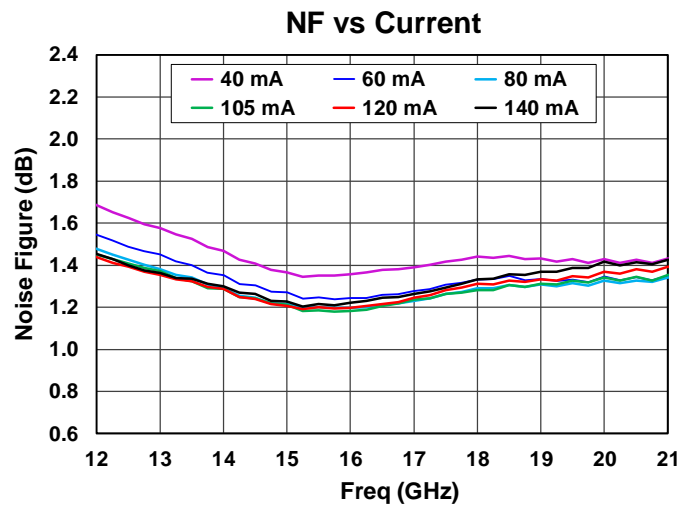
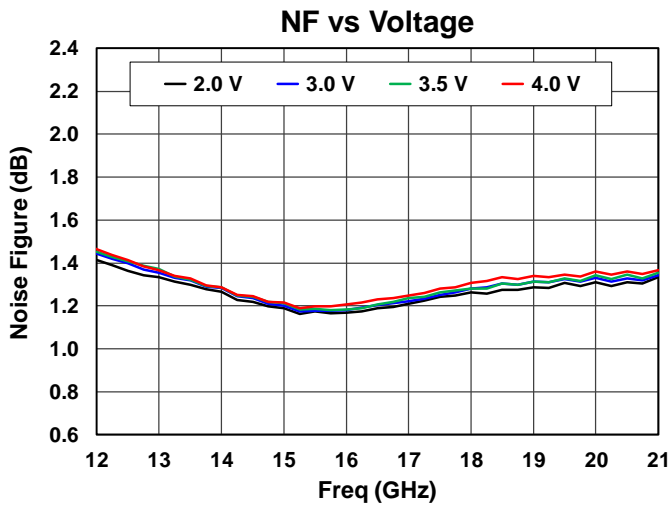
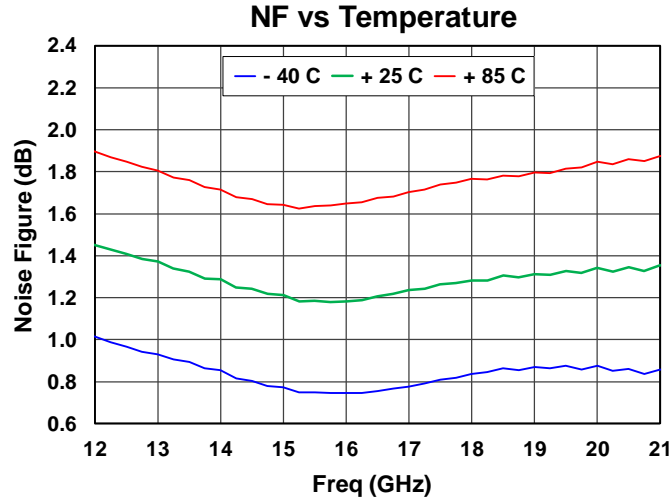

Performance Plots – Power

Test Conditions unless otherwise stated:  $V_D = 3.5\text{ V}$ ,  $I_{DQ} = 105\text{ mA}$ ,  $25\text{ }^\circ\text{C}$

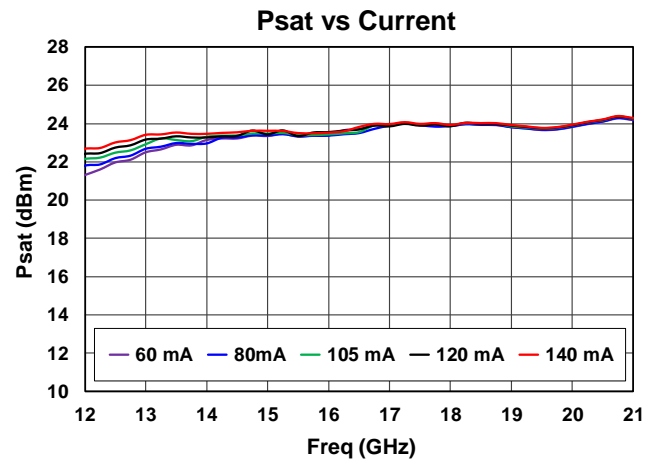
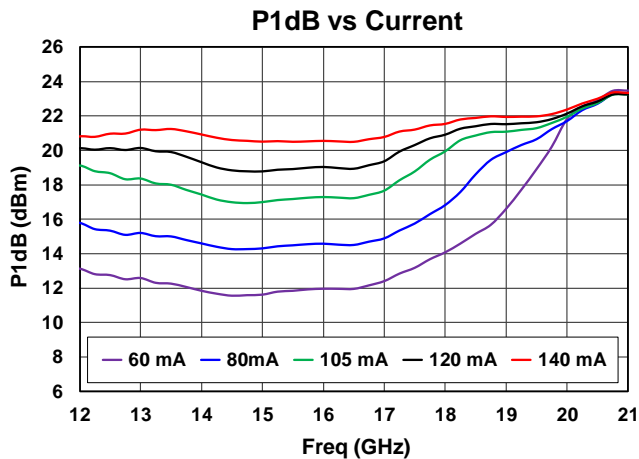
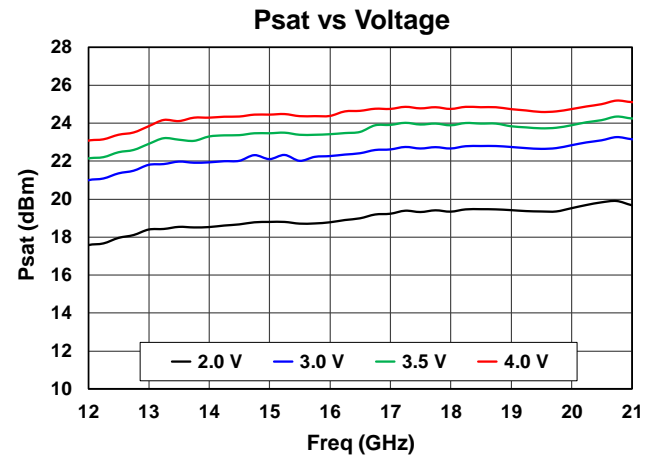
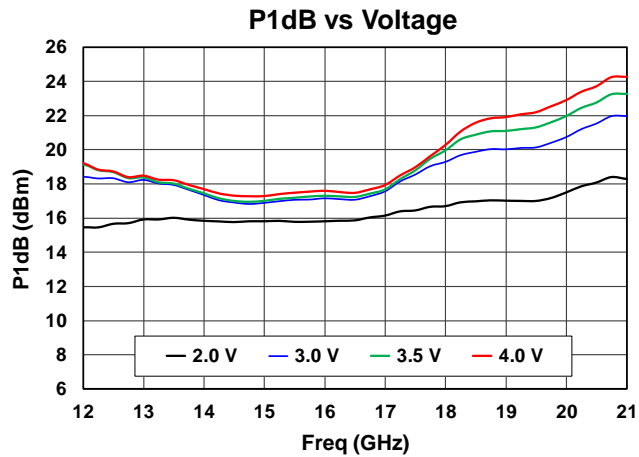
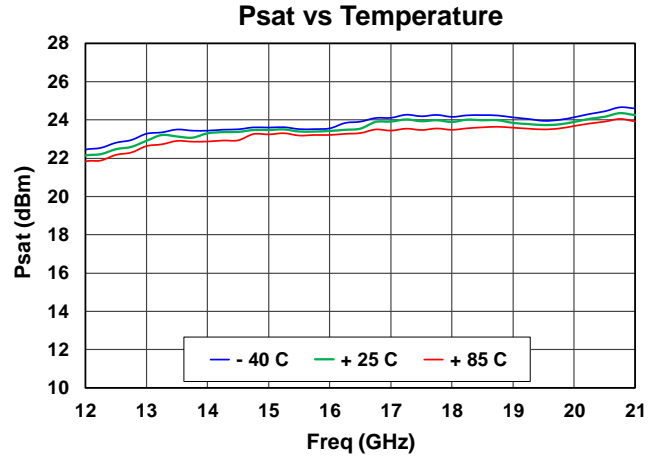
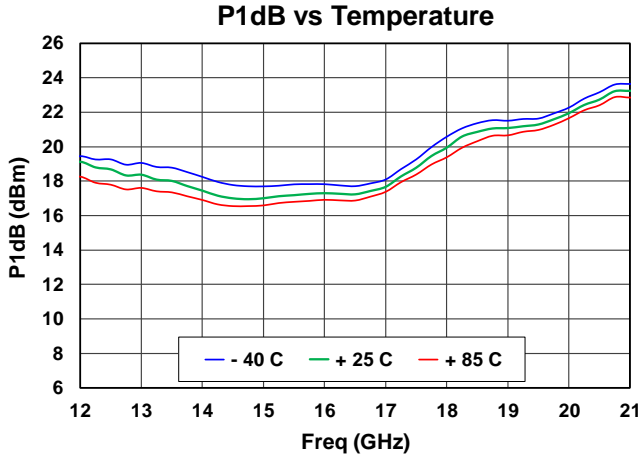

Performance Plots – Power Sweep

Test Conditions unless otherwise stated:  $V_D = 3.5\text{ V}$ ,  $I_{DQ} = 105\text{ mA}$ ,  $25\text{ }^\circ\text{C}$

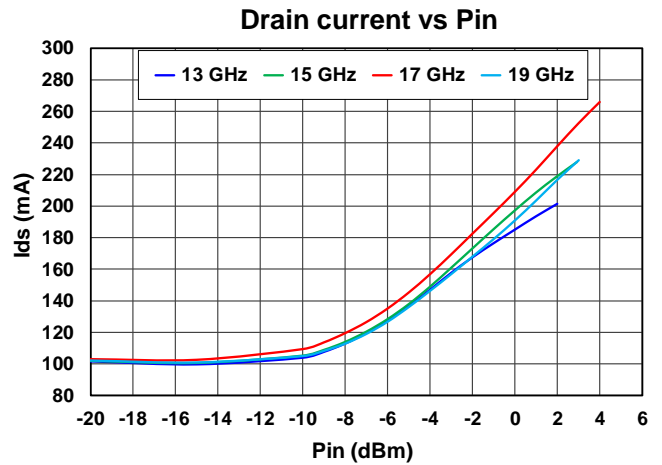
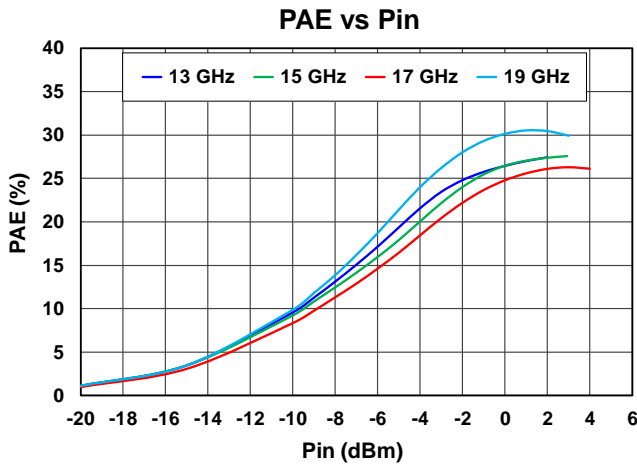
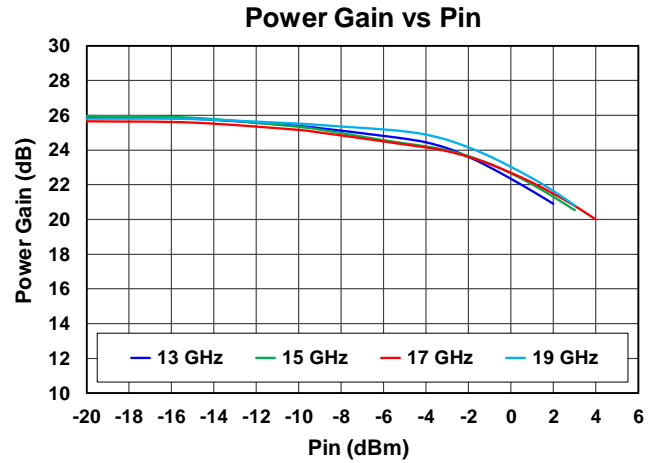
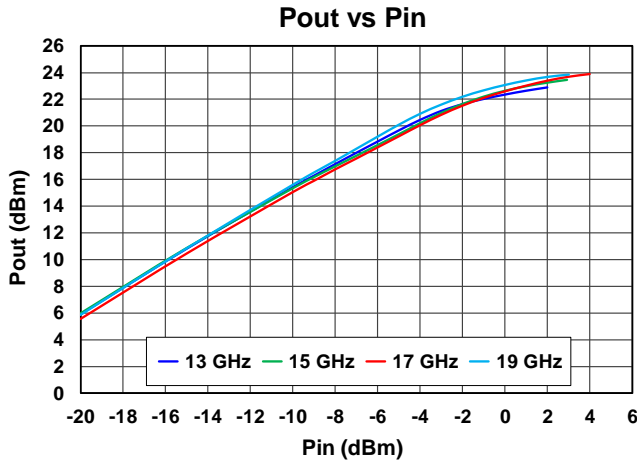

Performance Plots – Linearity

Test Conditions unless otherwise stated:  $V_D = 3.5\text{ V}$ ,  $I_{DQ} = 105\text{ mA}$ , Tone Spacing = 11 MHz, 25 °C.

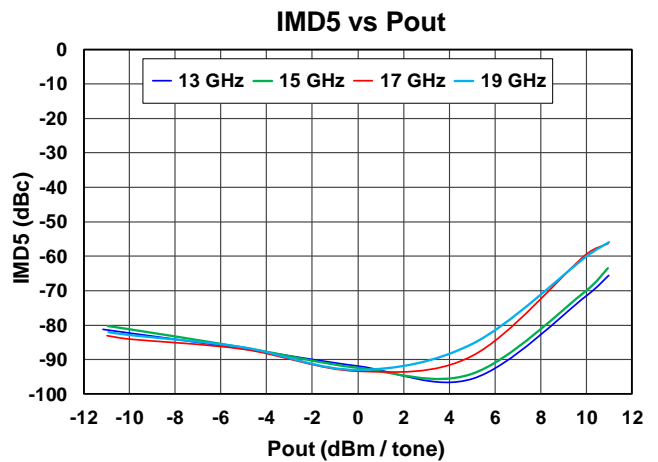
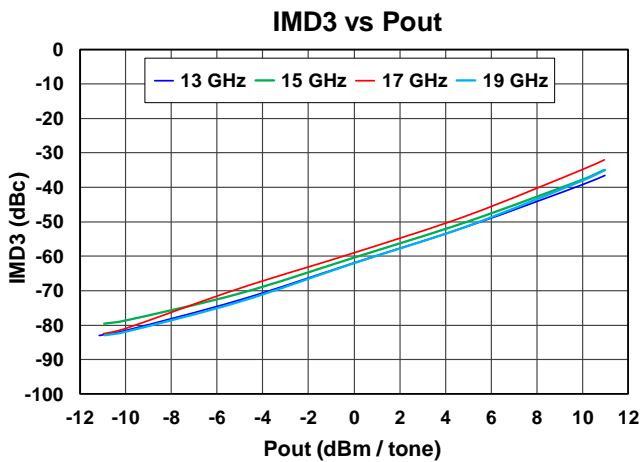
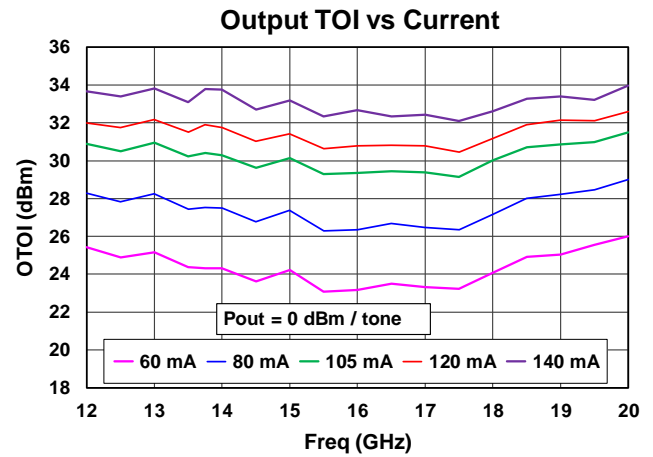
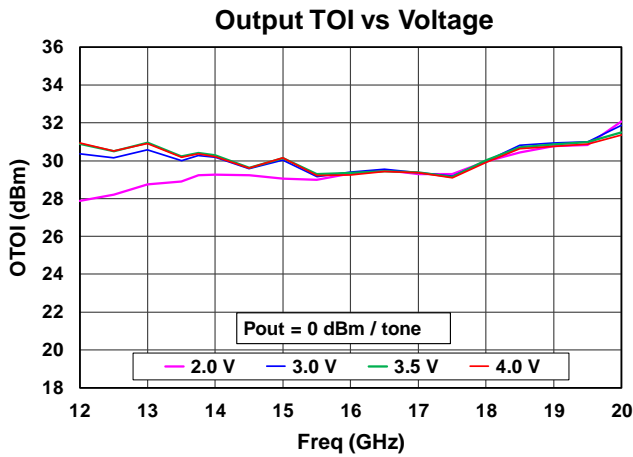
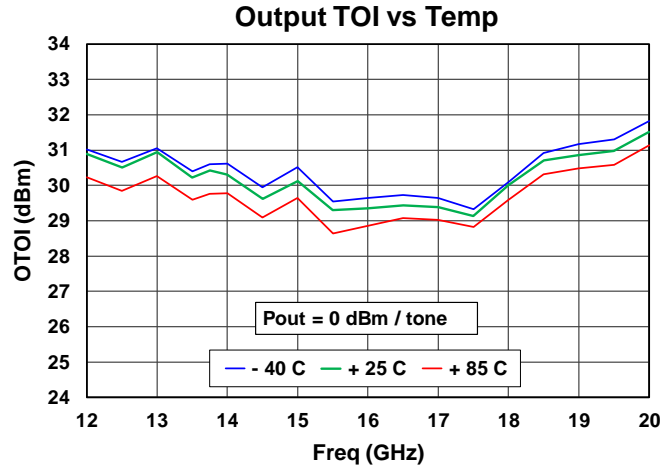



Mechanical Drawing & Pad Description

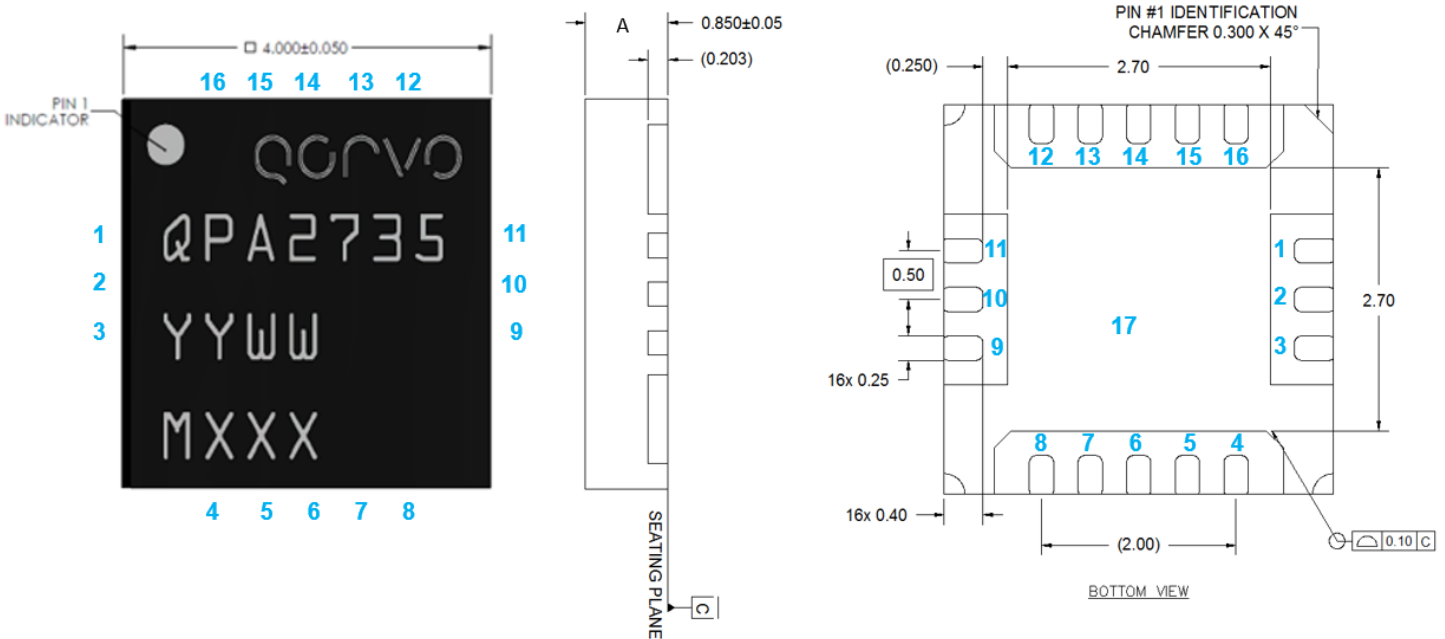

Dimensions in mm, package is mold encapsulated with NiPdAu plated leads

Part Marking: QPA2735 = Part Number, YY = Part Assembly Year  
 WW = Part Assembly Week, MXXX = Batch ID

Pin Number	Label	Description
1, 3, 9, 11, 17 (slug)	GND	GROUND
2	RF Input	Matched to 50 ohms, DC blocked
4	VG1	Stage 1 Gate Voltage (All gate control can be tied together at PCB)
6	VG2	Stage 2 Gate Voltage (All gate control can be tied together at PCB)
8	VG3	Stage 3 Gate Voltage (All gate control can be tied together at PCB)
10	RF Output	Matched to 50 ohms, DC blocked
12	VD3	Stage 3 Drain Voltage
14	VD2	Stage 2 Drain Voltage (VD1 and VD2 can be tied together at PCB)
16	VD1	Stage 1 Drain Voltage (VD1 and VD2 can be tied together at PCB)
5, 7, 13, 15	N/C	No internal connection. Recommend to GND at the PCB level

Application Circuit

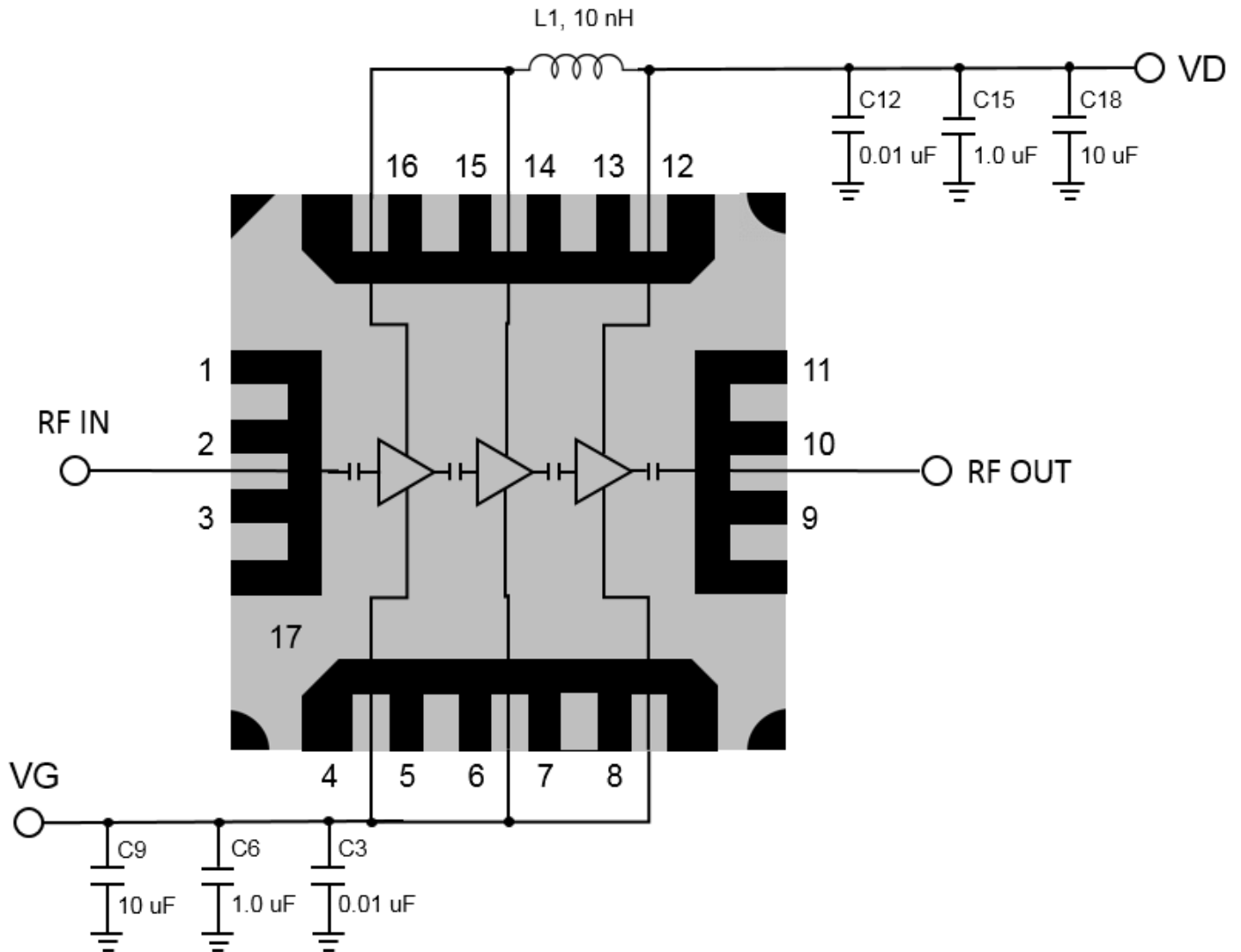

**Bias-up Procedure**

1. Set  $I_D$  limit to 220 mA,  $I_G$  limit to 10 mA
2. Set  $V_G$  to  $-1.3$  V
3. Set  $V_D$  +3.5 V
4. Adjust  $V_G$  more positive until  $I_{DQ} = 105$ mA ( $V_G \sim -0.46$  V Typical)
5. Apply RF signal

**Bias-down Procedure**

1. Turn off RF signal
2. Reduce  $V_G$  to  $-1.3$  V. Ensure  $I_{DQ} \sim 0$ mA
3. Set  $V_D$  to 0V
4. Turn off  $V_D$  supply
5. Turn off  $V_G$  supply

#### Evaluation Board and Assembly

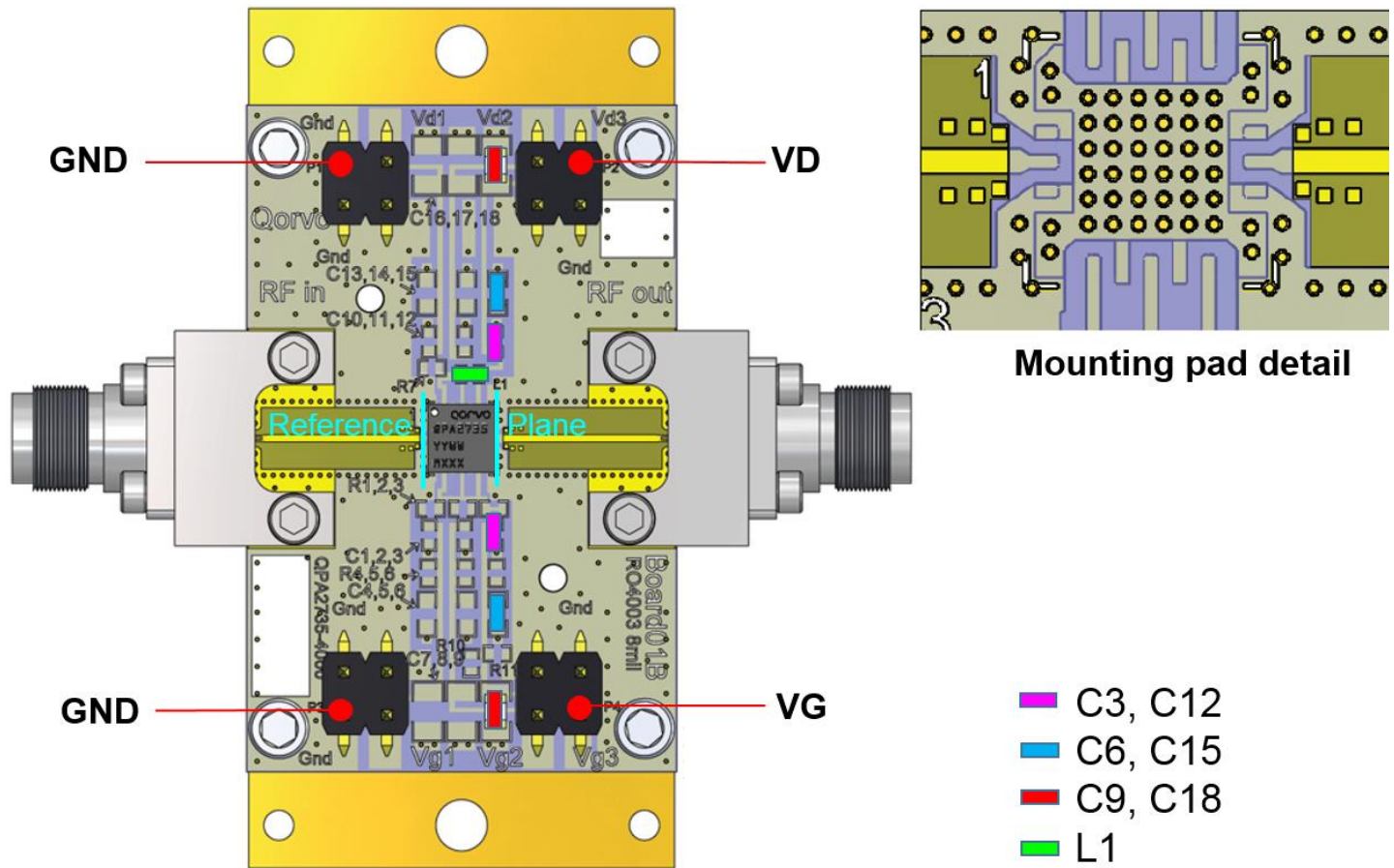

RF Layer is 0.008" thick Rogers Corp. RO4003C ( $\epsilon_r = 3.35$ ). Metal layers are 0.5 oz. copper. The microstrip line at the connector interface is optimized for the Southwest Microwave end launch connector 1092-01A-5.

#### Bill of Materials

Ref. Des.	Component	Value	Manuf.	Part Number
C3, C12	Surface Mount Cap.	CAP 0.01UF +/-10% 50V 0402 X7R ROHS	Various	
C6, C15	Surface Mount Cap.	CAP 1.0UF +/-10% 16V 0603 X7R ROHS	Various	
C9, C18	Surface Mount Cap.	CAP CER 10UF 10V X7R 10% 0805 TDK ROHS	Various	
L1	Surface Mount Ind.	IND 10 nH, 500 mA, 0402, 5.5 GHz, +/- 2%	Various	
RF IN, RF OUT	RF Connectors	2.92mm END LAUNCH CONNECTOR	Southwest Microwave	1092-01A-5

## Thermal and Reliability Information

Parameter	Test Conditions	Value	Units
Thermal Resistance ( $\theta_{JC}$ ) <sup>(1)</sup>	$T_{base} = 85^{\circ}\text{C}$ , $V_D = 3.5\text{ V}$ , $I_{DQ} = 105\text{ mA}$ Quiescent/Small Signal operation $P_{DISS} = 0.3675\text{ W}$	65.0	$^{\circ}\text{C/W}$
Channel Temperature ( $T_{CH}$ )		108.9	$^{\circ}\text{C}$
Median Lifetime ( $T_M$ )		6.8E07	Hrs

Notes:

1. Thermal resistance is referenced to the back of the package.

## Median Lifetime

Test Conditions:  $V_D = 4\text{ V}$   
 Failure Criteria = 10% reduction in  $I_{D\_MAX}$

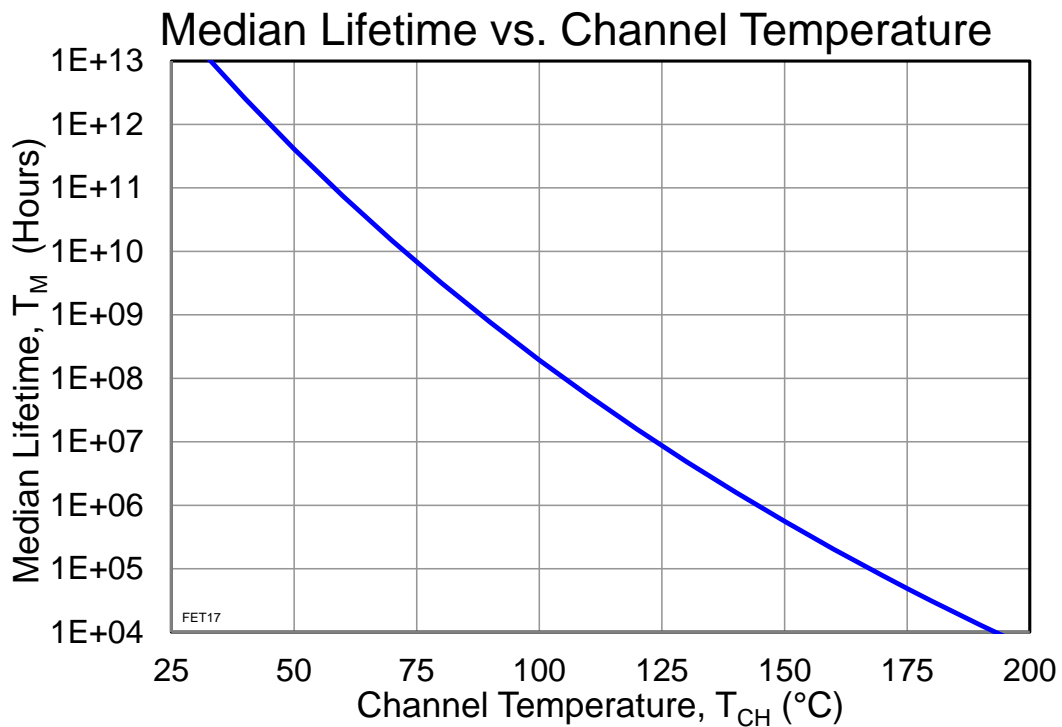

**Solderability**

1. Compatible with the latest version of J-STD-020, Lead-free solder, 260 °C peak reflow temperature.

**Recommended Soldering Temperature Profile**

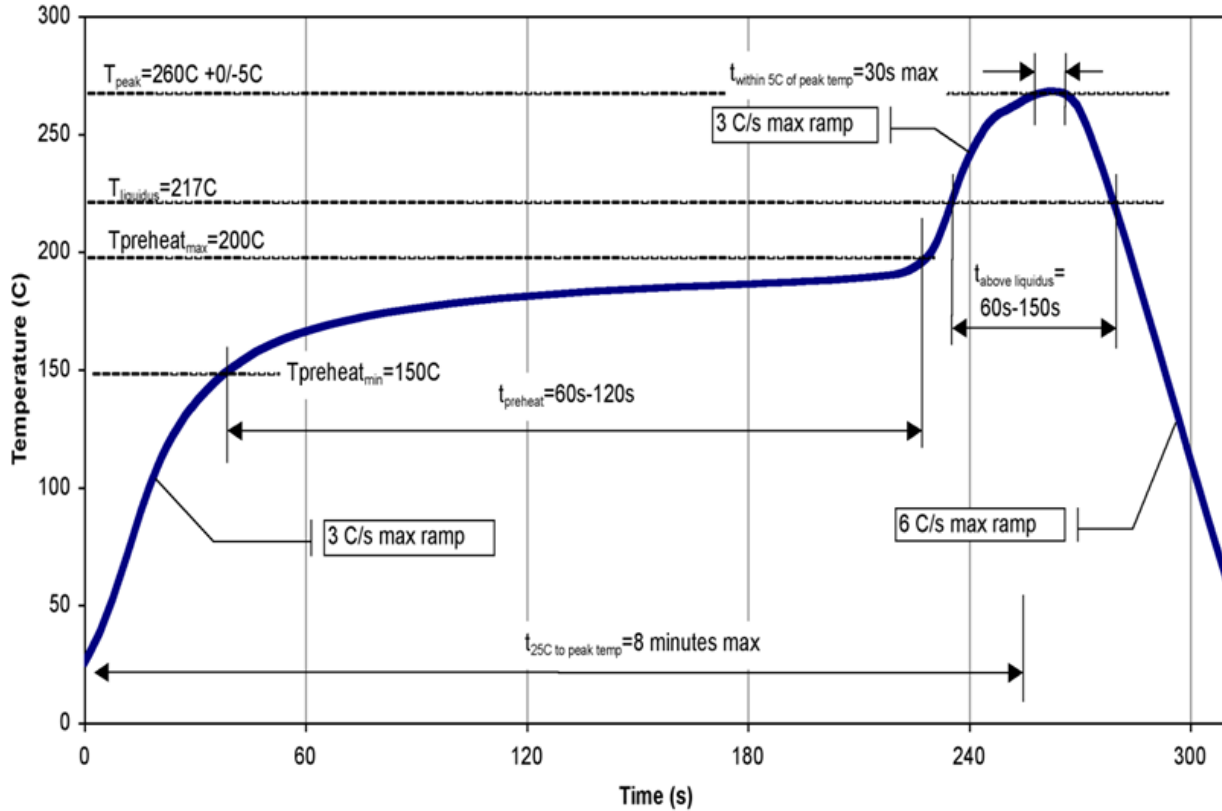

### Tape and Reel Information

Standard T/R size = 750 pieces on a 7" reel.

Material		Cavity (mm)				Distance Between Centerline (mm)		Carrier Tape (mm)	Cover Carrier (mm)
Vendor	Vendor P/N	Length (A0)	Width (B0)	Depth (K0)	Pitch (P1)	Length direction (P2)	Width Direction (F)	Width (W)	Width (W)
Tek-Pak	QFN0400X0 400D	4.35	4.35	1.10	8.00	2.00	5.50	12.00	9.20

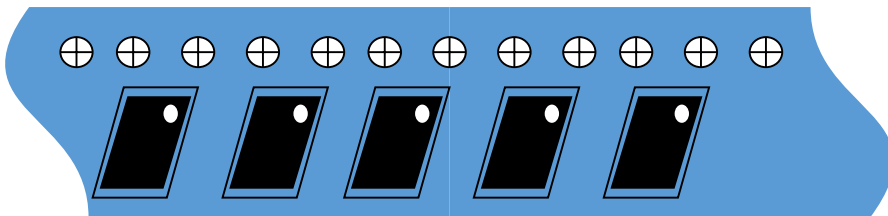
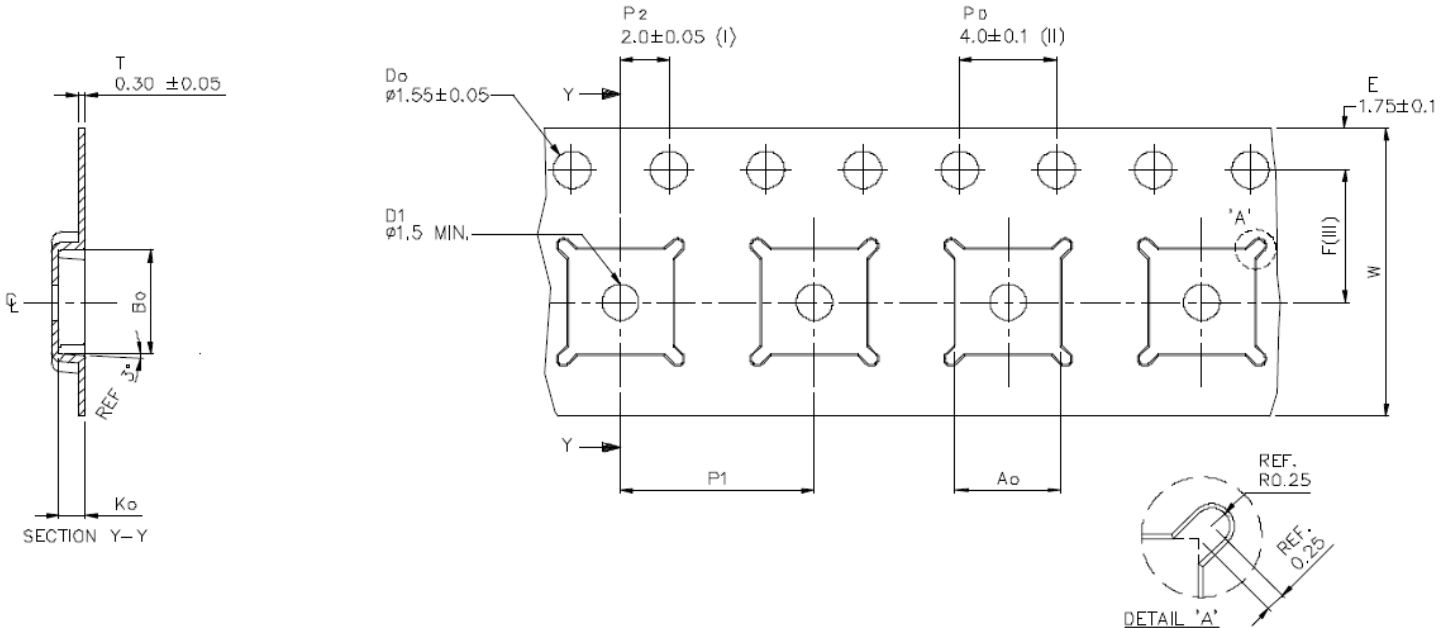

## Handling Precautions

Parameter	Rating	Standard
ESD – Human Body Model (HBM)	1A	ESDA / JEDEC JS-001-2012
ESD – Charged Device Model (CDM)	C3	ESDA / JEDEC JS-002-2014
MSL – Convection Reflow 260 °C	3	JEDEC standard IPC/JEDEC J-STD-020



Caution!  
ESD-Sensitive Device

## RoHS Compliance

This product is compliant with the 2011/65/EU RoHS directive (Restrictions on the Use of Certain Hazardous Substances in Electrical and Electronic Equipment), as amended by Directive 2015/863/EU.

This product also has the following attributes:

- Lead Free
- Halogen Free (Chlorine, Bromine)
- Antimony Free
- TBBP-A (C<sub>15</sub>H<sub>12</sub>Br<sub>4</sub>O<sub>2</sub>) Free
- SVHC Free

## Contact Information

For the latest specifications, additional product information, worldwide sales and distribution locations:

**Tel:** 1-844-890-8163

**Web:** [www.qorvo.com](http://www.qorvo.com)

**Email:** [customer.support@qorvo.com](mailto:customer.support@qorvo.com)

## Important Notice

The information contained herein is believed to be reliable; however, Qorvo makes no warranties regarding the information contained herein and assumes no responsibility or liability whatsoever for the use of the information contained herein. All information contained herein is subject to change without notice. Customers should obtain and verify the latest relevant information before placing orders for Qorvo products. The information contained herein or any use of such information does not grant, explicitly or implicitly, to any party any patent rights, licenses, or any other intellectual property rights, whether with regard to such information itself or anything described by such information. **THIS INFORMATION DOES NOT CONSTITUTE A WARRANTY WITH RESPECT TO THE PRODUCTS DESCRIBED HEREIN, AND QORVO HEREBY DISCLAIMS ANY AND ALL WARRANTIES WITH RESPECT TO SUCH PRODUCTS WHETHER EXPRESS OR IMPLIED BY LAW, COURSE OF DEALING, COURSE OF PERFORMANCE, USAGE OF TRADE OR OTHERWISE, INCLUDING THE IMPLIED WARRANTIES OF MERCHANTABILITY AND FITNESS FOR A PARTICULAR PURPOSE.**

Without limiting the generality of the foregoing, Qorvo products are not warranted or authorized for use as critical components in medical, life-saving, or life-sustaining applications, or other applications where a failure would reasonably be expected to cause severe personal injury or death.

Copyright 2020 © Qorvo, Inc. | Qorvo is a registered trademark of Qorvo, Inc.

# Mouser Electronics

Authorized Distributor

Click to View Pricing, Inventory, Delivery & Lifecycle Information:

[Qorvo:](#)

[QPA2735EVBP1](#) [QPA2735TR7](#) [QPA2735TR7X](#) [QPA2735EVB](#)