

## 2N7002W-G (N-Channel) RoHS Device

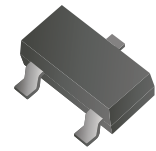

V(BR)DSS	RDS(on)MAX	ID
60V	5Ω @ 10V	115mA
	7Ω @ 5V	

### Features

- High density cell design for low R<sub>DS(ON)</sub>.
- Voltage controlled small signal switch.
- Rugged and reliable.
- High saturation current capability.

### Mechanical data

- Case: SOT-323, molded plastic.
- Terminals: Solderable per MIL-STD-750, method 2026.
- Weight: 0.006 grams(approx.)

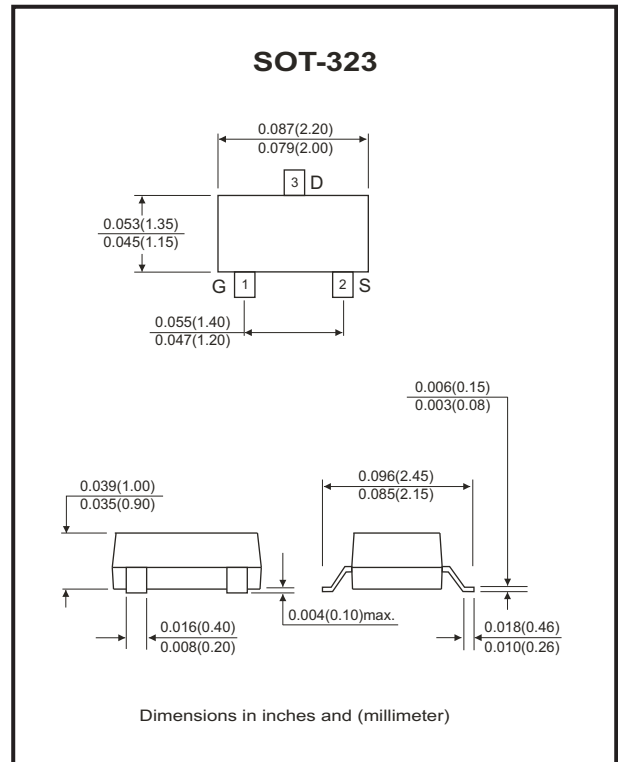

### Equivalent Circuit

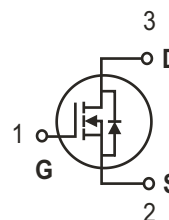

1. G : Gate
2. S : Source
3. D : Drain

### Maximum Ratings (at T<sub>A</sub>=25°C unless otherwise noted)

Parameter	Conditions	Symbol	Value	Unit
Drain-Source voltage		V <sub>DS</sub>	60	V
Gate-Source voltage		V <sub>GS</sub>	20	V
Continuous drain current		I <sub>D</sub>	115	mA
Power dissipation		P <sub>D</sub>	200	mW
Thermal resistance	Junction to ambient	R <sub>θJA</sub>	625	°C/W
Junction temperature range		T <sub>J</sub>	-55 to +150	°C
Storage temperature range		T <sub>STG</sub>	-55 to +150	°C

## Electrical Characteristics (at TA=25°C unless otherwise noted)

Parameter	Conditions	Symbol	Min	Typ	Max	Unit
Drain-source breakdown voltage	$V_{GS}=0V, I_D=250\mu A$	$V_{BR(DSS)}$	60			V
Gate-threshold voltage	$V_{DS}=V_{GS}, I_D=250\mu A$	$V_{th(GS)}$	1	1.6	2.5	V
Gate-body leakage	$V_{DS}=0V, V_{GS}=\pm 20V$	$I_{GSS}$			$\pm 80$	nA
Zero gate voltage drain current	$V_{DS}=60V, V_{GS}=0V$	$I_{DSS}$			80	nA
On-state drain current	$V_{GS}=10V, V_{DS}=7V$	$I_{D(ON)}$	500			mA
Drain-source on resistance	$V_{GS}=10V, I_D=500mA$	$R_{DS(ON)}$		0.9	5	$\Omega$
	$V_{GS}=5V, I_D=50mA$			1.1	7	
Forward trans conductance	$V_{DS}=10V, I_D=200mA$	$g_{fs}$	80			mS
Drain-source on-voltage	$V_{GS}=10V, I_D=500mA$	$V_{DS(ON)}$			3.75	V
	$V_{GS}=5V, I_D=50mA$				0.375	
Diode forward voltage	$I_S=115mA, V_{GS}=0V$	$V_{SD}$	0.55		1.2	V
Input capacitance *	$V_{DS}=25V, V_{GS}=0V, f=1MHz$	$C_{iss}$			50	pF
Output capacitance *		$C_{oss}$			25	
Reverse transfer capacitance *		$C_{rss}$			5	
<b>Switching Time</b>						
Turn-on time *	$V_{DD}=25V, R_L=50\Omega, I_D=500mA, V_{GEN}=10V, R_G=25\Omega$	$t_{d(on)}$			20	nS
Turn-off time *		$t_{d(off)}$			40	

Note: \* These parameters have no way to verify

## RATING AND CHARACTERISTIC CURVES (2N7002W-G)

Fig.1 - Output Characteristics

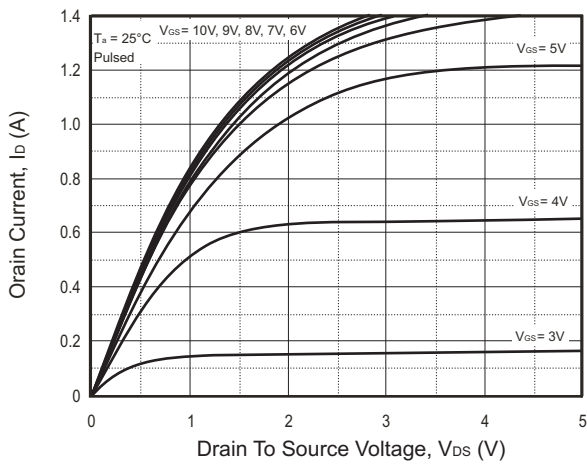

Fig.2 - Transfer Characteristics

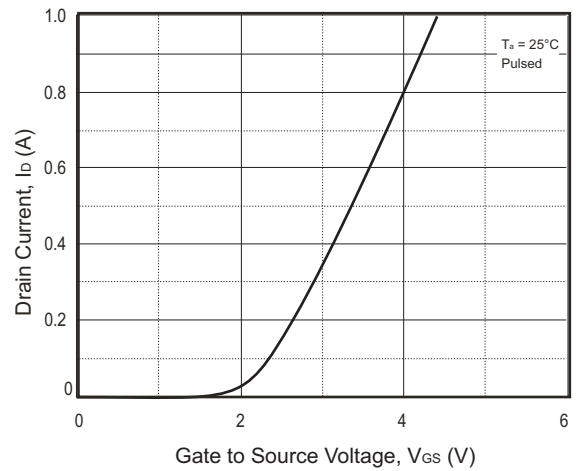

Fig.3 -  $R_{DS(ON)}$  —  $I_D$

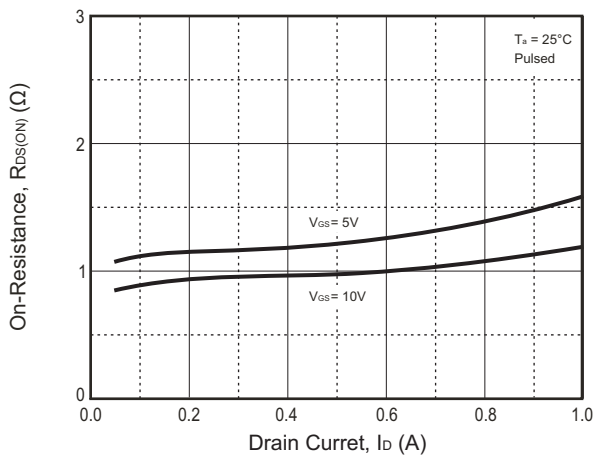

Fig.4 -  $R_{DS(ON)}$  —  $V_{GS}$

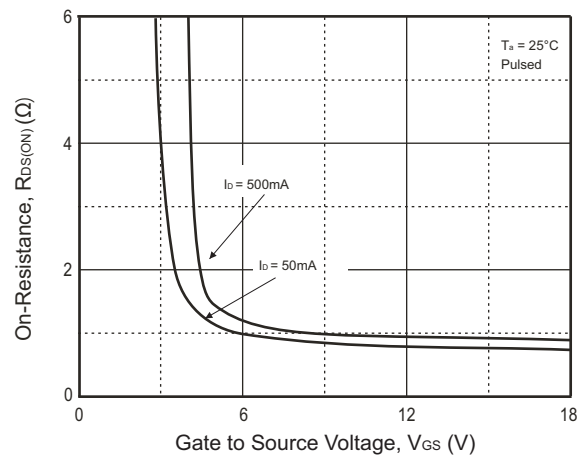
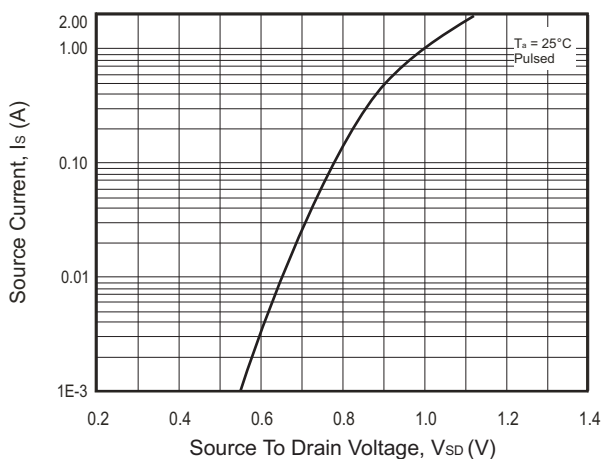
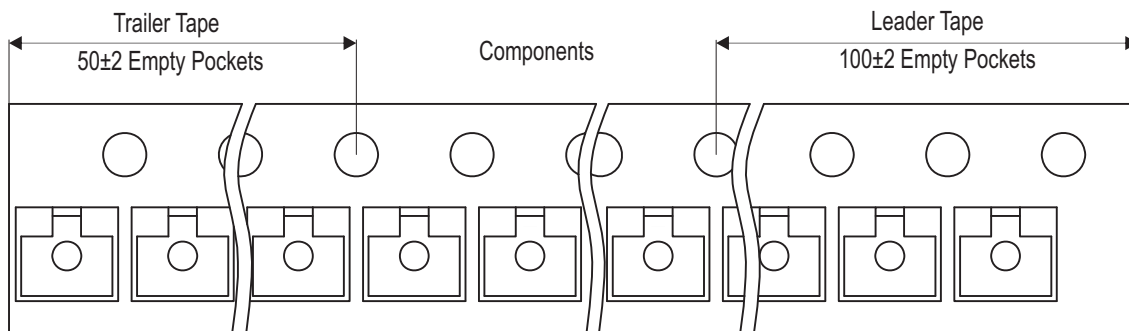
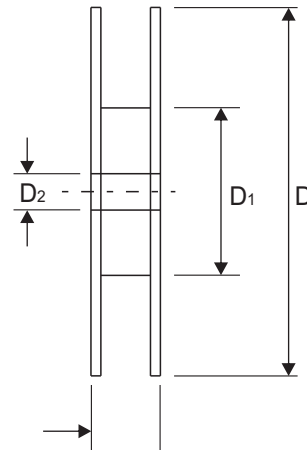
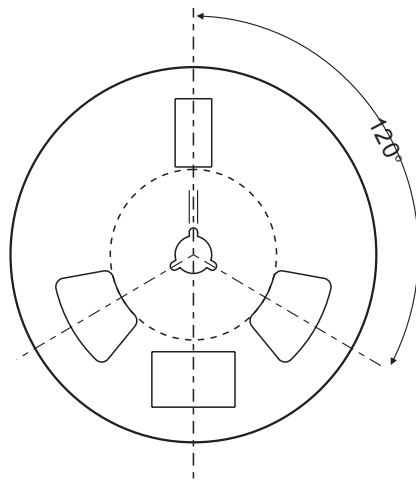
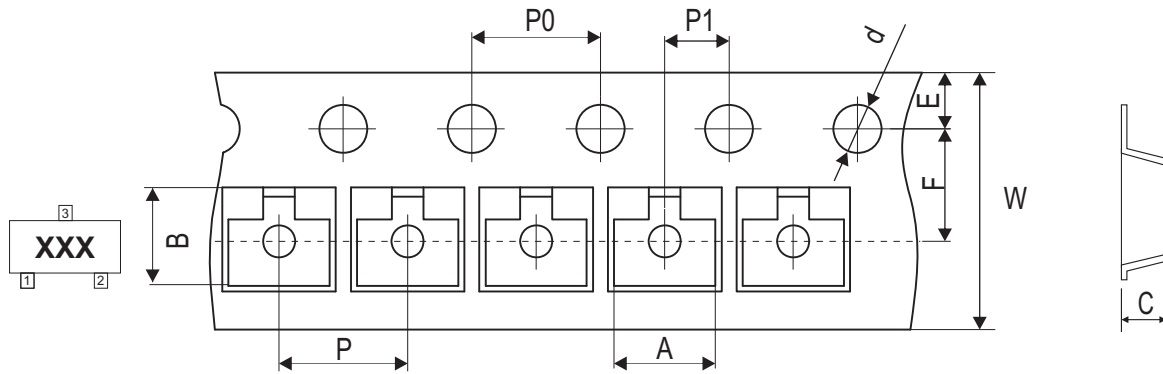

Fig.5 -  $I_S$  —  $V_{SD}$



## Reel Taping Specification



SOT-323	SYMBOL	A	B	C	d	D	D1	D2
	(mm)	2.25 ± 0.05	2.55 ± 0.05	1.19 ± 0.05	1.55 ± 0.10	178.00 ± 2.00	54.40 ± 1.00	13.00 ± 1.00
	(inch)	0.089 ± 0.002	0.100 ± 0.002	0.047 ± 0.002	0.061 ± 0.004	7.008 ± 0.079	2.142 ± 0.039	0.512 ± 0.039

SOT-323	SYMBOL	E	F	P	P0	P1	W	W1
	(mm)	1.75 ± 0.10	3.50 ± 0.10	4.00 ± 0.10	4.00 ± 0.10	2.00 ± 0.10	8.00 + 0.30 / - 0.10	12.30 ± 1.00
	(inch)	0.069 ± 0.004	0.138 ± 0.004	0.157 ± 0.004	0.157 ± 0.004	0.079 ± 0.004	0.315 + 0.012 / - 0.004	0.484 ± 0.039

Company reserves the right to improve product design , functions and reliability without notice.

REV:B

## Marking Code

Part Number	Marking Code
2N7002W-G	K72

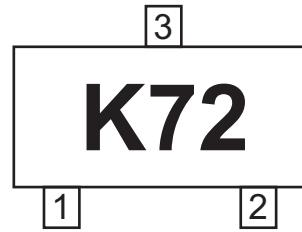

## Suggested PAD Layout

SIZE	SOT-323	
	(mm)	(inch)
A	0.80	0.031
B	0.50	0.020
C	1.30	0.051
D	2.20	0.087

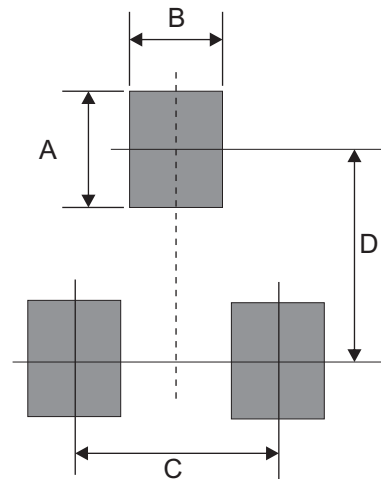

## Standard Packaging

Case Type	REEL PACK	
	REEL ( pcs )	Reel Size (inch)
SOT-323	3,000	7

# Mouser Electronics

Authorized Distributor

Click to View Pricing, Inventory, Delivery & Lifecycle Information:

[Comchip Technology:](#)

[2N7002W-G](#)