

**PLEASE CHECK WWW.MOLEX.COM FOR LATEST PART INFORMATION**

**Part Number:** [0039532044](#)  
**Status:** **Active**  
**Overview:** Easy-On FFC FPC Connectors  
**Description:** 1.25mm Pitch Easy-On FFC/FPC Connector, Through-Hole, Right-Angle, ZIF, Top Contact Style, 4 Circuits

**Documents:**

<a href="#">3D Model</a>	<a href="#">Product Specification PS-5597-004-001 (PDF)</a>
<a href="#">Drawing (PDF)</a>	<a href="#">Packaging Specification SPK-5597-003-001 (PDF)</a>
<a href="#">3D Model (PDF)</a>	<a href="#">RoHS Certificate of Compliance (PDF)</a>

**Agency Certification**

UL E29179

**General**

Product Family	FFC/FPC Connectors
Series	5597
Overview	<a href="#">Easy-On FFC FPC Connectors</a>
Product Name	Easy-On
UPC	822348170111

**Physical**

Actuator Type	Slider
Circuits (Loaded)	4
Circuits (maximum)	4
Color - Resin	Natural
Contact Position	Top
Durability (mating cycles max)	30
Flammability	94V-0
Mated Height	5.00mm
Material - Metal	Phosphor Bronze
Material - Plating Mating	Tin-Bismuth
Material - Plating Termination	Tin-Bismuth
Material - Resin	Polyester
Net Weight	512.160/mg
Number of Rows	1
Orientation	Right Angle
PC Tail Length	3.50mm
PCB Locator	No
PCB Mounting	Through Hole
PCB Retention	None
Packaging Type	Tray
Pitch - Mating Interface	1.25mm
Plating min - Mating	1.016µm
Plating min - Termination	1.016µm
Polarized to PCB	No
Stackable	No
Surface Mount Compatible (SMC)	No
Temperature Range - Operating	-20° to +80°C
Wire/Cable Type	FFC/FPC

**Electrical**

Current - Maximum per Contact	1.0A
Voltage - Maximum	200V

**Material Info**

Engineering Number 5597-04APB7F

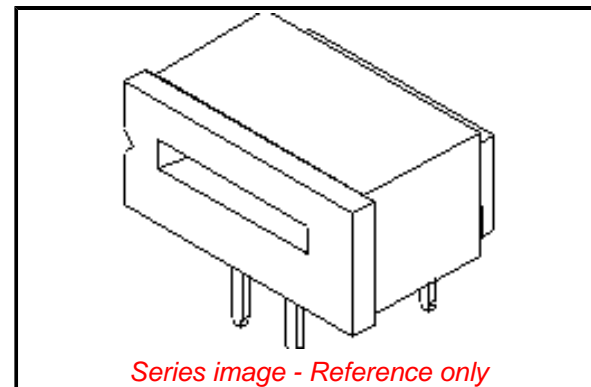

**EU ELV**

**Not Relevant**

**EU RoHS**

**Compliant**

**REACH SVHC**

Not Contained Per -  
D(2020)9139-DC (19  
Jan 2021)

**Halogen-Free**

**Status**

**Not Low-Halogen**

For more information, please visit [Contact US](#)

China ROHS

ELV

RoHS Phthalates

**China RoHS**

Green Image

Not Relevant

Not Contained

**Search Parts in this Series**

[5597 Series](#)

**Reference - Drawing Numbers**

Packaging Specification

Product Specification

Sales Drawing

SPK-5597-003-001

PS-5597-004-001

SD-5597-011-001

This document was generated on 02/19/2021

**PLEASE CHECK [WWW.MOLEX.COM](http://WWW.MOLEX.COM) FOR LATEST PART INFORMATION**