

PLEASE CHECK WWW.MOLEX.COM FOR LATEST PART INFORMATION

Part Number: [0039012161](#)
Status: **Active**
Overview: [Mini-Fit Jr.™ Power Connectors](#)
Description: Mini-Fit Jr.™ Plug Housing, Dual Row, 16 Circuits, UL 94V-2, with Panel Mounting Ears, Natural

Documents:

3D Model	Product Specification PS-5556-001 (PDF)
Drawing (PDF)	Packaging Specification PK-5559-001-001 (PDF)
Product Specification PS-45750-001-001 (PDF)	RoHS Certificate of Compliance (PDF)

Agency Certification

CSA	LR19980
UL	E29179

General

Product Family	Crimp Housings
Series	5559
Application	Power, Wire-to-Board, Wire-to-Wire
Comments	Current = 13A max. per circuit when header is mated to a receptacle loaded with 45750 series terminals crimped to 16 AWG wire. . See Molex product specification PS-45750-001 for additional current derating information.
MolexKits	Yes
Overview	Mini-Fit Jr.™ Power Connectors
Product Name	Mini-Fit Jr.™
UPC	800753583979

Physical

Breakaway	No
Circuits (maximum)	16
Color - Resin	Natural
Flammability	94V-2
Gender	Plug
Glow-Wire Compliant	No
Material - Resin	Nylon
Net Weight	4.782/g
Number of Rows	2
Packaging Type	Bag
Panel Mount	Yes
Pitch - Mating Interface	4.20mm
Pitch - Termination Interface	4.20mm
Polarized to Mating Part	Yes
Stackable	No
Temperature Range - Operating	-40°C to +105°C

Electrical

Current - Maximum per Contact	13.0A
-------------------------------	-------

Material Info

Engineering Number	5559-16P
--------------------	----------

Reference - Drawing Numbers

Packaging Specification	PK-5559-001-001
Product Specification	PS-45750-001-001, PS-5556-001
Sales Drawing	SD-5559-NP-000

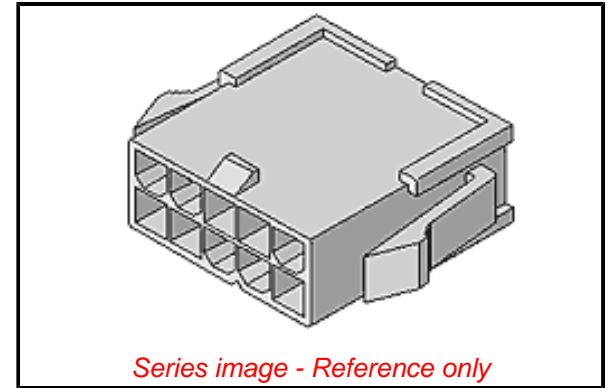

EU ELV

Not Relevant

EU RoHS

Compliant

REACH SVHC

Not Contained Per
-ED/01/2017 (12
January 2017)

Halogen-Free

Status

Low-Halogen

Need more information on product environmental compliance?

Email productcompliance@molex.com
Please visit the [Contact Us](#) section for any non-product compliance questions.

China ROHS

ELV

RoHS Phthalates

Green Image

Not Relevant

Not Contained

Search Parts in this Series

[5559](#) Series

Mates With

Dual Row Receptacle Housing [5557](#)

Use With

[5558](#) , [30490](#) Male Terminal

This document was generated on 02/15/2017

PLEASE CHECK WWW.MOLEX.COM FOR LATEST PART INFORMATION