

General Description

The MAX77818 evaluation system (EV system) consists of a MAX77818 evaluation kit (EV kit) and a companion Maxim MINIUSB interface board.

The MAX77818 EV kit is an assembled and tested PC board that demonstrates the MAX77818. The IC contains 12V input and 3A output switching mode charger.

The Maxim MINIUSB interface board allows an IBM-compatible PC to use its USB port to emulate an I²C 2-wire interface. Windows XP®/Windows® 7 software provides a user-friendly interface to exercise the features of the MAX77818. The menu-driven program offers a graphical user interface with control buttons.

Applications

- Smartphones and Tablets
- Other Handheld Devices

Benefits and Features

- Demonstrates 12V_{CHGIN}, 3A Charge
- Demonstrates m5 Fuel Gauge Performance
- Demonstrates Dual Input Charge
- Demonstrates OTG Mode
- Evaluates MAX77818 Detail Performances

Ordering Information appears at end of data sheet.

Windows and Windows XP are registered trademarks and registered service marks of Microsoft Corporation.

Required Equipment

- IBM PC-compatible computer capable of running Windows XP/Windows 7
- PC with an unused USB port
- Standard Mini-USB cable to connect the computer's USB port to the Maxim MINIUSB interface board
- DC power supply capable of supplying 15.0V/3A

Initial Test Setup

Do not turn on the DC power supplies until all connections are made.

- 1) Carefully connect the boards by aligning the 20-pin connector of the MAX77818 EV kit with the 20-pin header of the MINIUSB interface board. Gently press them together. The two boards should be flush against each other.
- 2) Connect a cable from the computer's USB port to the MINIUSB interface board. Use the USB cable that Maxim provides.
- 3) Install the MAXIM MINIUSB driver when PC prompts USB device detection.
- 4) Connect a single cell Li-Ion battery to the pads labeled BATT+ and BATT-.
- 5) Connect the DC power supply capable of supplying 15V ±0.2V/3A to the pads labeled VBUS and GND on the MAX77818 EV board.
- 6) Turn on the 5V DC power supply.
- 7) Start the MAX77818 program by opening its icon in the **Start** menu. The MAX77818.EXE software program can be run from the hard drive using Windows. If desired, use the INSTALL.EXE program to copy the files and create icons for them in the Windows XP/Window 7 **Start** menu. An uninstall program is included with the software. Click on the UNINSTALL icon to remove the EV kit software from the hard drive.
- 8) Observe as the program automatically detects the address of the MAX77818 and starts the main program.

Detailed Description of Software

The software provides an easy-to-use, point-and-click method to exercise all of the features of the MAX77818.

The software can control most of function blocks of the MAX77818.

Main Display

The charger current, top-off current level, and all other charger related functions can be programmed in **Charger** section list boxes. All FG section parameters can be programmed in separate FG GUI.

Simple 2-Wire Interface Commands

There are methods for communicating the MAX77818 through either the main display or the simple 2-wire interface commands available by using the **Advanced Tab and 2-Wire Interface** window. A display pops up to allow 2-wire interface protocols, such as read byte and write byte to be individually executed. When using the 2-wire interface general commands, uncheck **Device-Present Checking** to prevent any errors from occurring. The general command dialog boxes accept numeric data in binary, decimal, or hexadecimal. Hexadecimal numbers should be prefixed by \$ or 0x. Binary numbers must be exactly 8 bits.

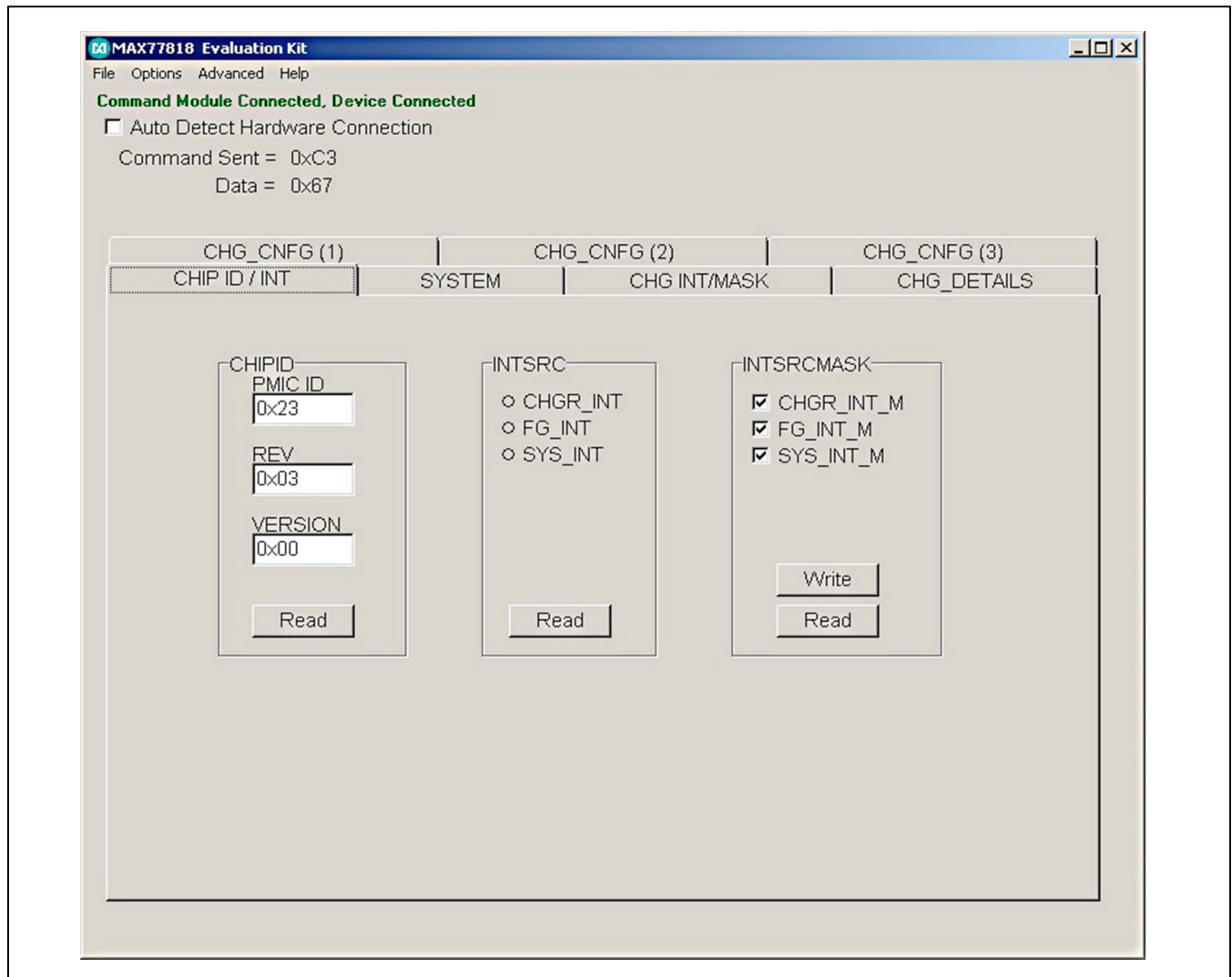

Figure 1. MAX77818 EV Kit GUI Screen

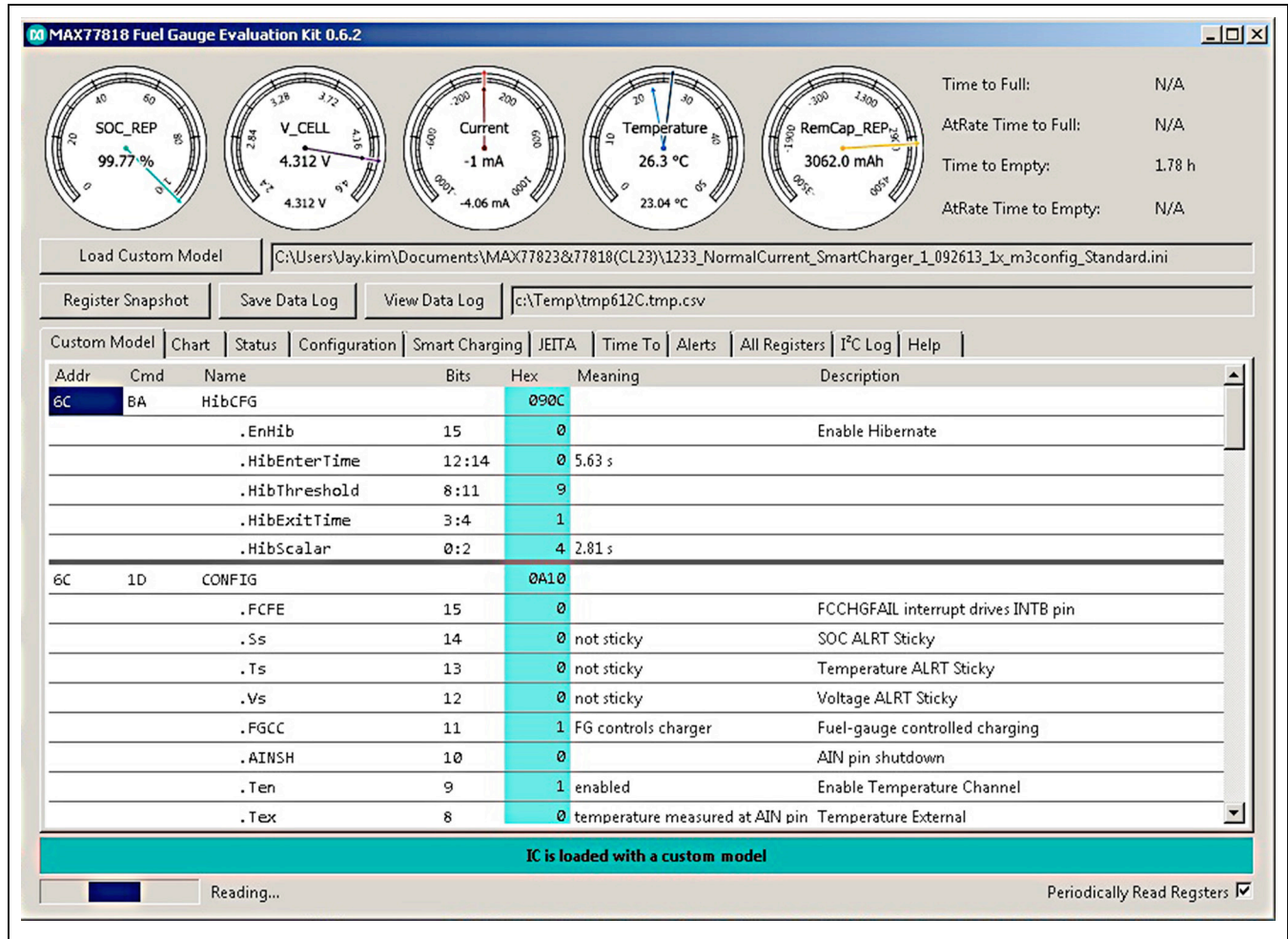

Figure 2. MAX77818 EV Kit Fuel Gauge GUI Screen

Detailed Description of Hardware

Battery Charger Test Setup

- 1) When using the DC power supply, adjust its voltage and current limit to 5.0V with 3.0A current limited.
- 2) Connect a single cell Li-Ion battery between BATT+ and BATT-.
- 3) Connect the 5.0V/3A current limited DC power supply between VBUS and GND.
- 4) Monitor the DC power supply current meter if the current reading is the same as the fast charge current that is set.

- 5) Open software screen and program the charger settings adequate to your system.
- 6) Use data log equipment to log charge current and VBATT profile while charging a fully discharged single cell Li+ battery.

Table 1. Jumper Settings

JUMPER NO.	DEFAULT POSITION	FUNCTION	PCB SILKSCREEN
JU8	Open between JU2: 1-2	VIO from external or VSYS	VIO

Fuel Gauge Test Setup

- 1) Close MAX77818 EV kit GUI. Fuel gauge uses a separate GUI.
- 2) Open FG section software screen and see if FG reads proper OCV and SOC while charging.
- 3) Open FG section software screen and see if FG reads proper OCV and SOC while discharging.

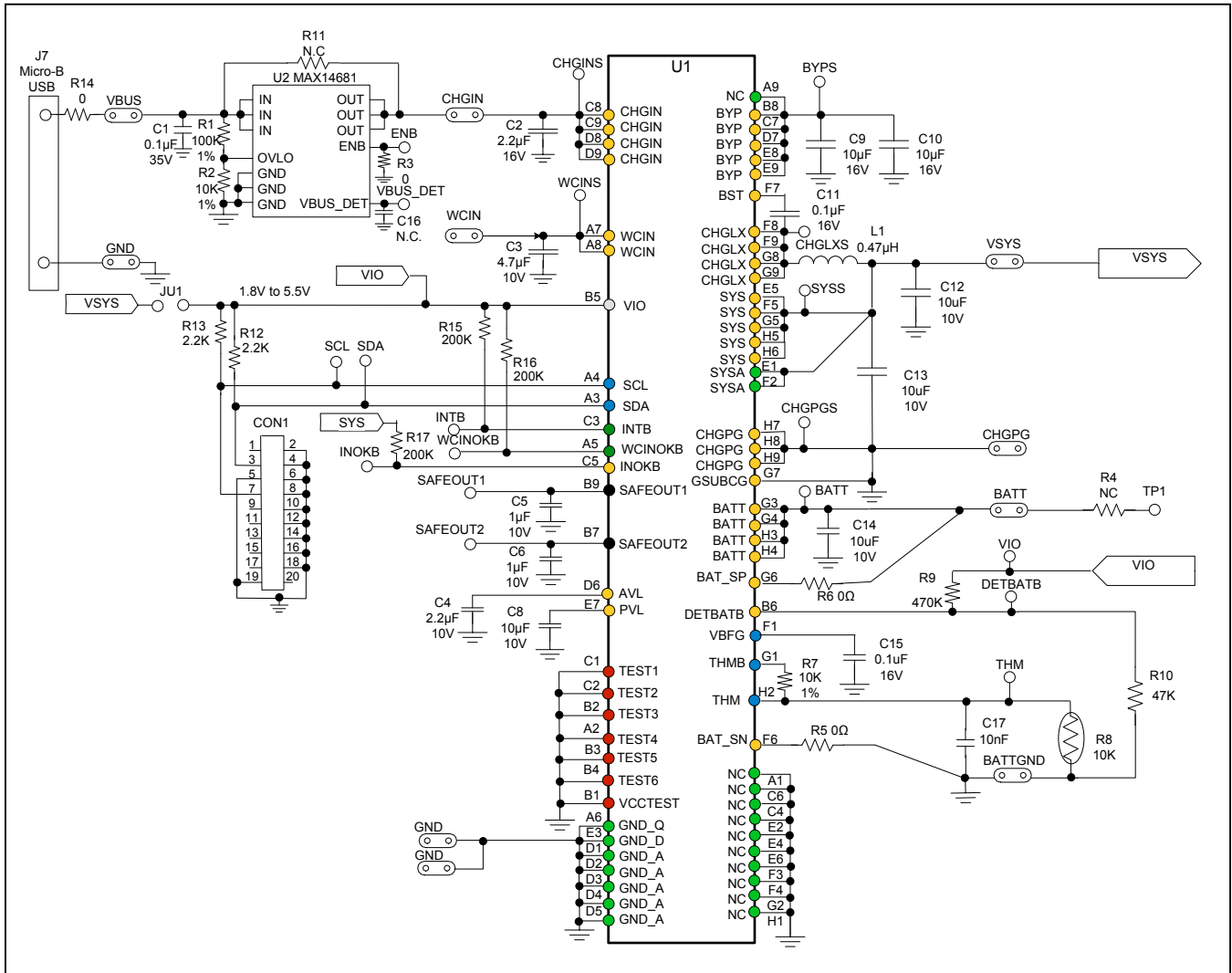

Figure 3. Schematic Diagram

MAX77818 EV System Component List

PART	QTY	DESCRIPTION
MAX77818EVKIT	1	MAX77818 evaluation kit
MAXIM MINIQUSB	1	MINIQUSB interface board

MAX77818 EV Kit Component List

DESIGNATION	QTY	DESCRIPTION
C1	1	0.1 μ F, 35V or 50V, 0402 ceramic capacitor Taiyo Yuden GMK105BJ104MV
C2, C4	2	2.2 μ F, 16V, 0603, ceramic capacitor Taiyo Yuden EMK107BJ225MA
C3	1	4.7 μ F, 10V, 0603, ceramic capacitor Taiyo Yuden LMK107BJ475MA
C5, C6	2	1 μ F, 10V, X5R, 0402, ceramic capacitor Taiyo Yuden LMK105BJ105MV
C8, C12–C14	4	10 μ F, 10V, X5R, 0603, ceramic capacitor Taiyo Yuden LMK107BBJ106MAL
C9, C10	2	10 μ F, 16V, X5R, 0603, ceramic capacitor Taiyo Yuden EMK107BBJ106MAL
C11, C15	2	0.1 μ F, 16V or higher, X5R, 0402, ceramic capacitor Taiyo Yuden EMK105BJ104MP
C16	1	N.C.
C17	1	10nF, 6.3V or higher, X5R, 0402 Taiyo Yuden TMK105BJ103MP
L1	1	0.47 μ H, 2016, TOKO DFE201610P-H-R47M 1 μ H, 2520, TOKO, DFE252012C 1239AS-H-1R0M
CON1	1	2x 10 right-angle female receptacle
VBUS, CHGIN, WCIN, VSYS, BATT, BATTGND, CHGPG, GND	11	MAXIM LOOP

DESIGNATION	QTY	DESCRIPTION
BYPS, ENB, VBUS_DET, SYSS, BATTs, SCL, SDA, INOKB, INTB, WCINOKB, SAFEOUT1, SAFEOUT2, TP1, CHGINS, WCINS, CHGPGS, CHGLXS, DETBATB, THM, VIO	20	Test point, small
R1	1	100k Ω , 1%, resistor, 0402
R2, R7	2	10k Ω , 1%, resistor, 0402
R3, R5, R6, R14	4	0 Ω , 0402
R12, R13	2	2.2k Ω , 5%, resistor, 0402
R15–R17	3	200k Ω , 5%, resistor, 0402
R9	1	470k Ω , 5%, resistor, 0402
R10	1	47k Ω , 5%, resistor, 0402
R4, R11	2	N.C.
U1	1	MAX77818EWZ+ 72-bump WLP, 0.4mm pitch
U2	1	MAX14681
THM	1	10 Ω , 1%, NTC, 0402
JU1	1	Two-pin header
JU2–JU11 (socket board only)	10	Two-pin header
J7	1	Micro B receptacle SMD type Panasonic, AXJ53312G

Note: All resistors are 0402 size.

PCB Layout Guide

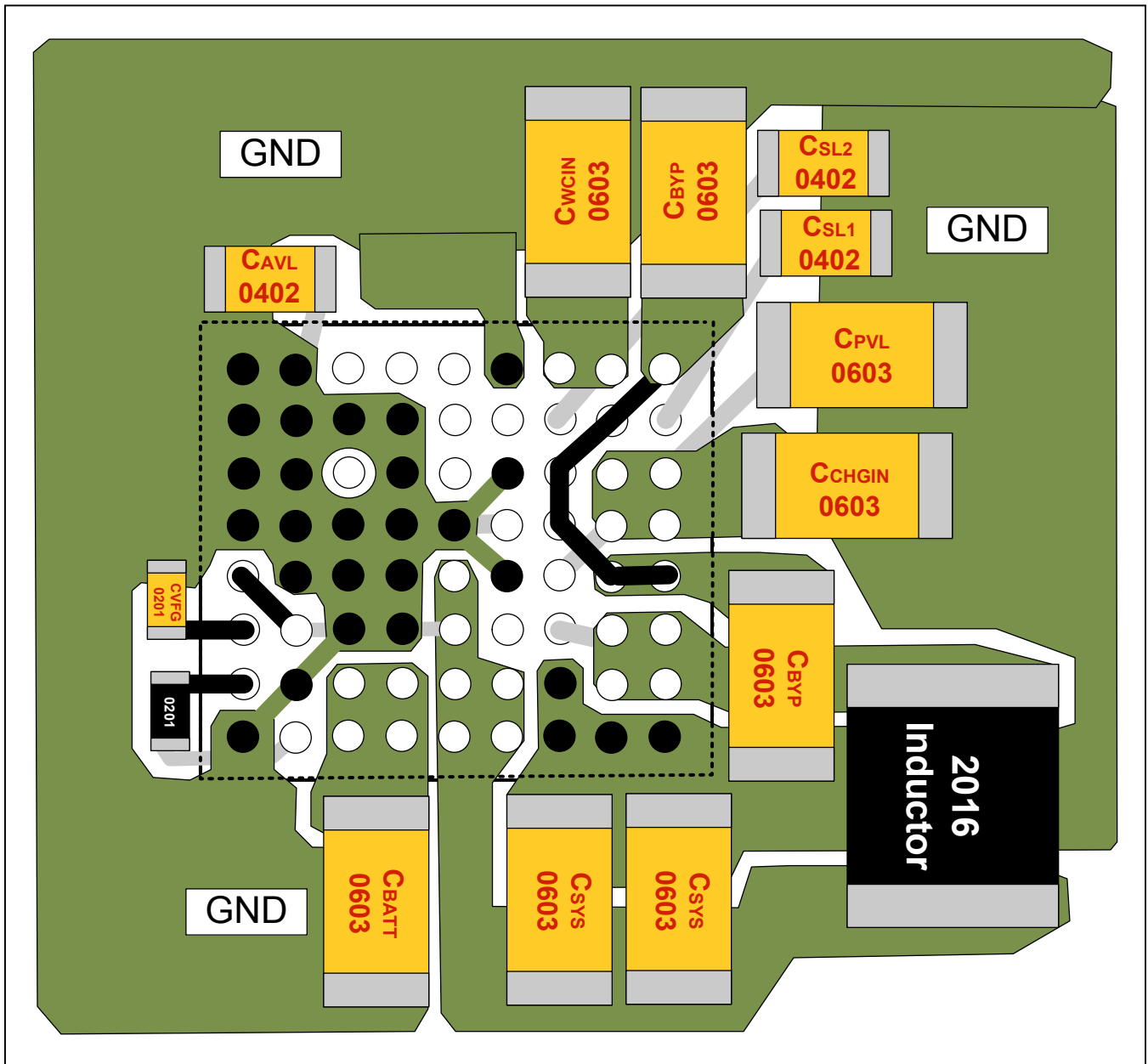

Figure 4. PCB Layout

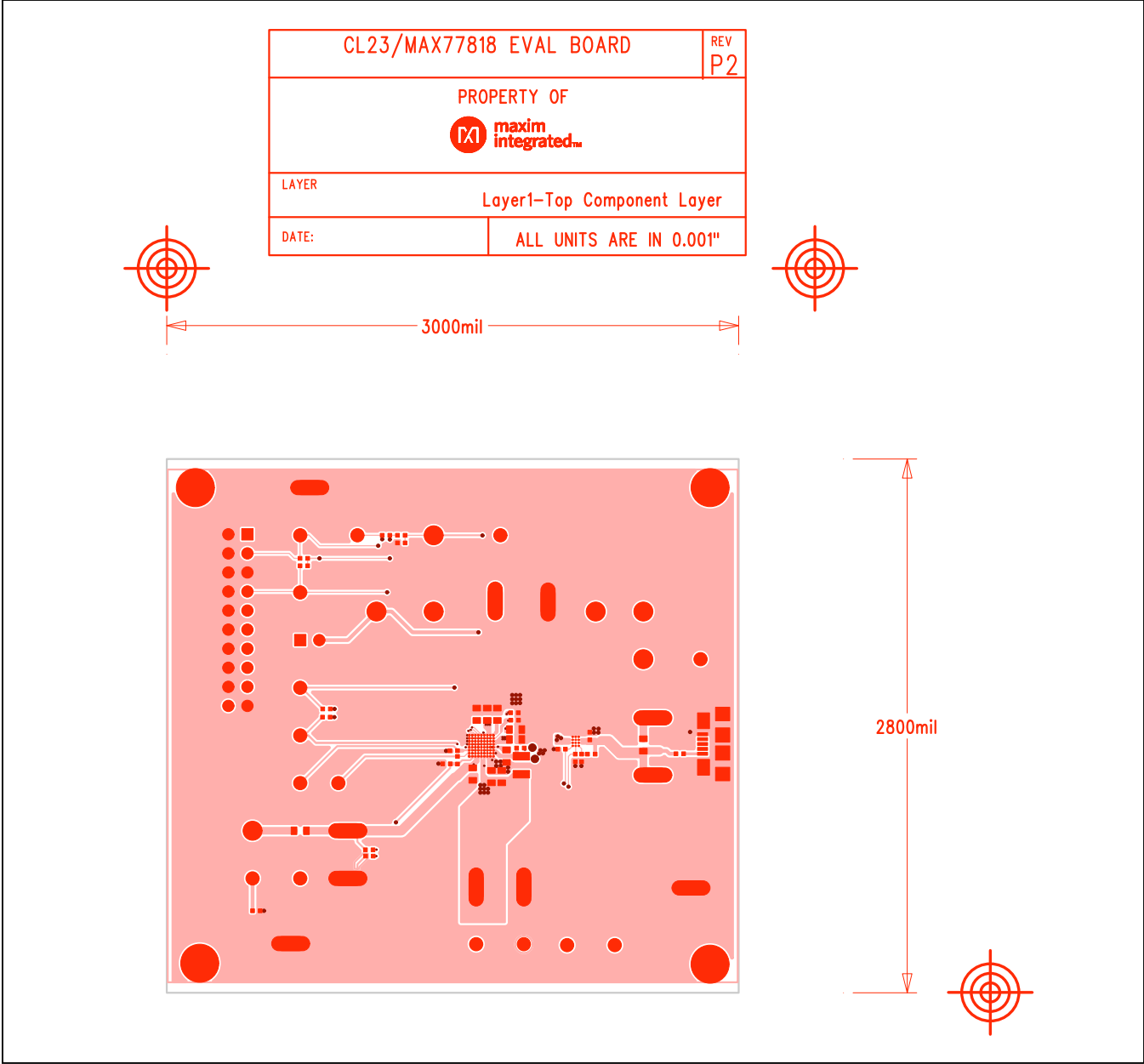

Figure 5. PCB Layout—Top Layer

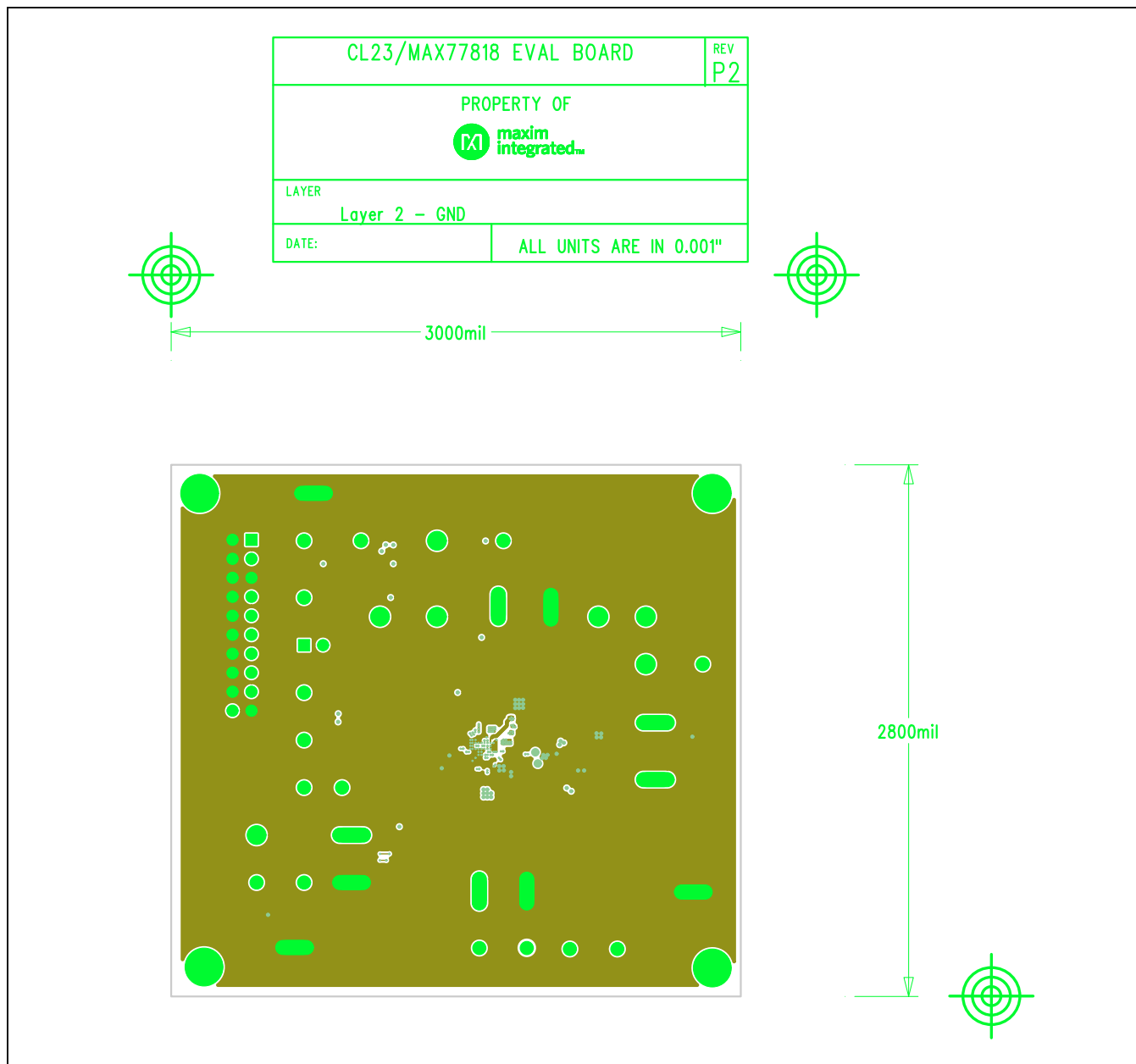

Figure 6. PCB Layout—Inner Layer 2

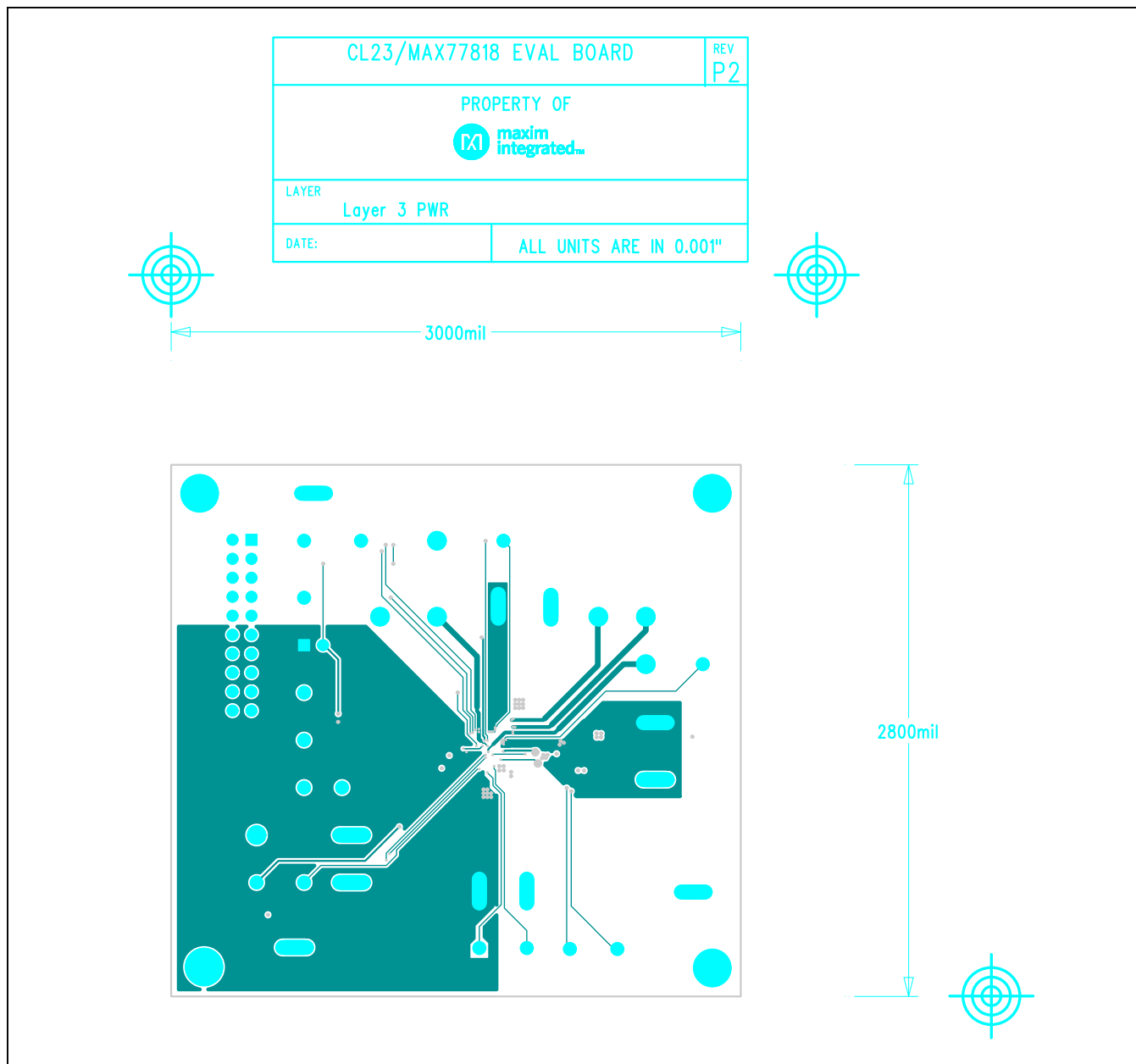

Figure 7. PCB Layout—Inner Layer 3

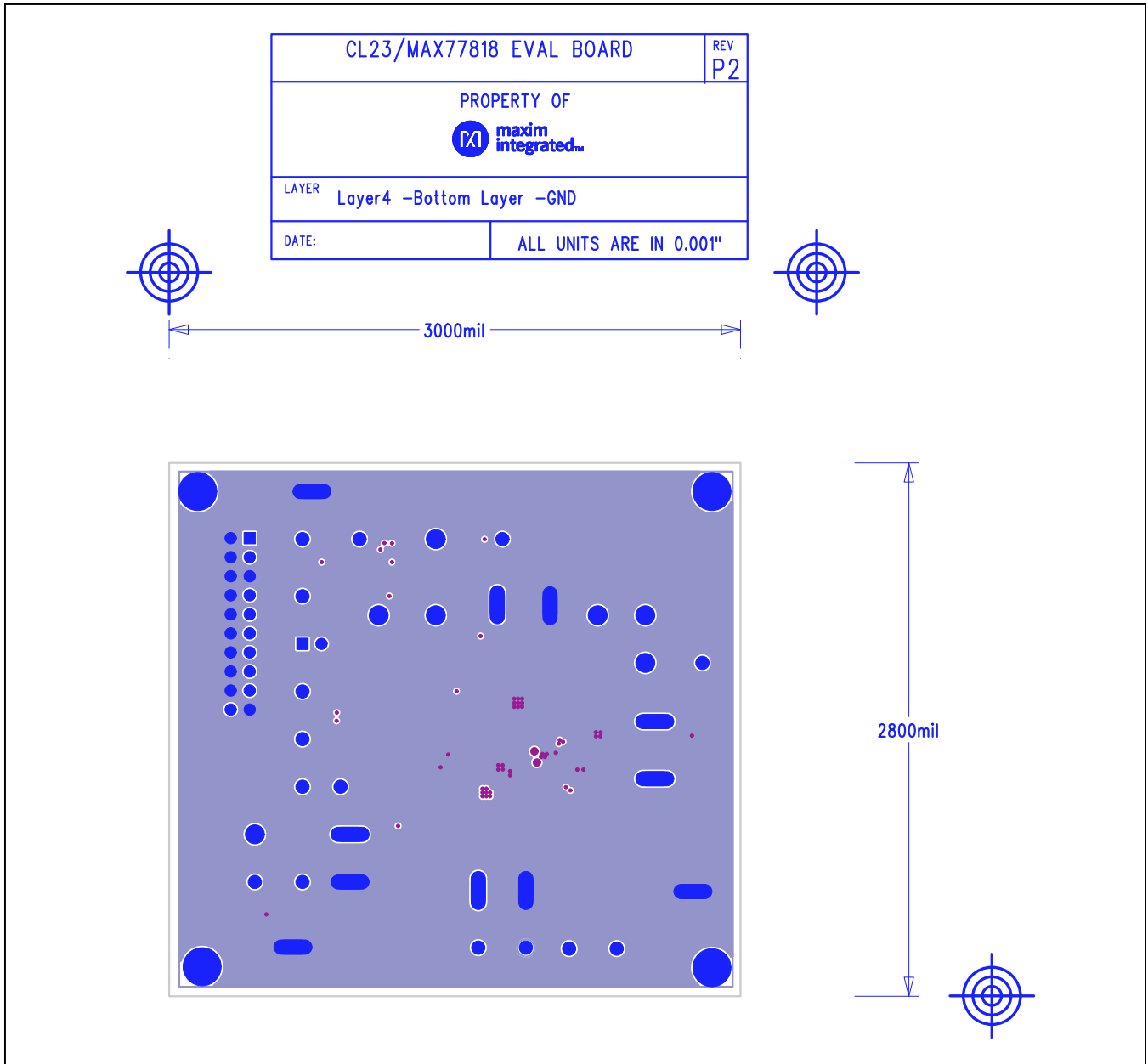

Figure 8. PCB Layout—Bottom Layer

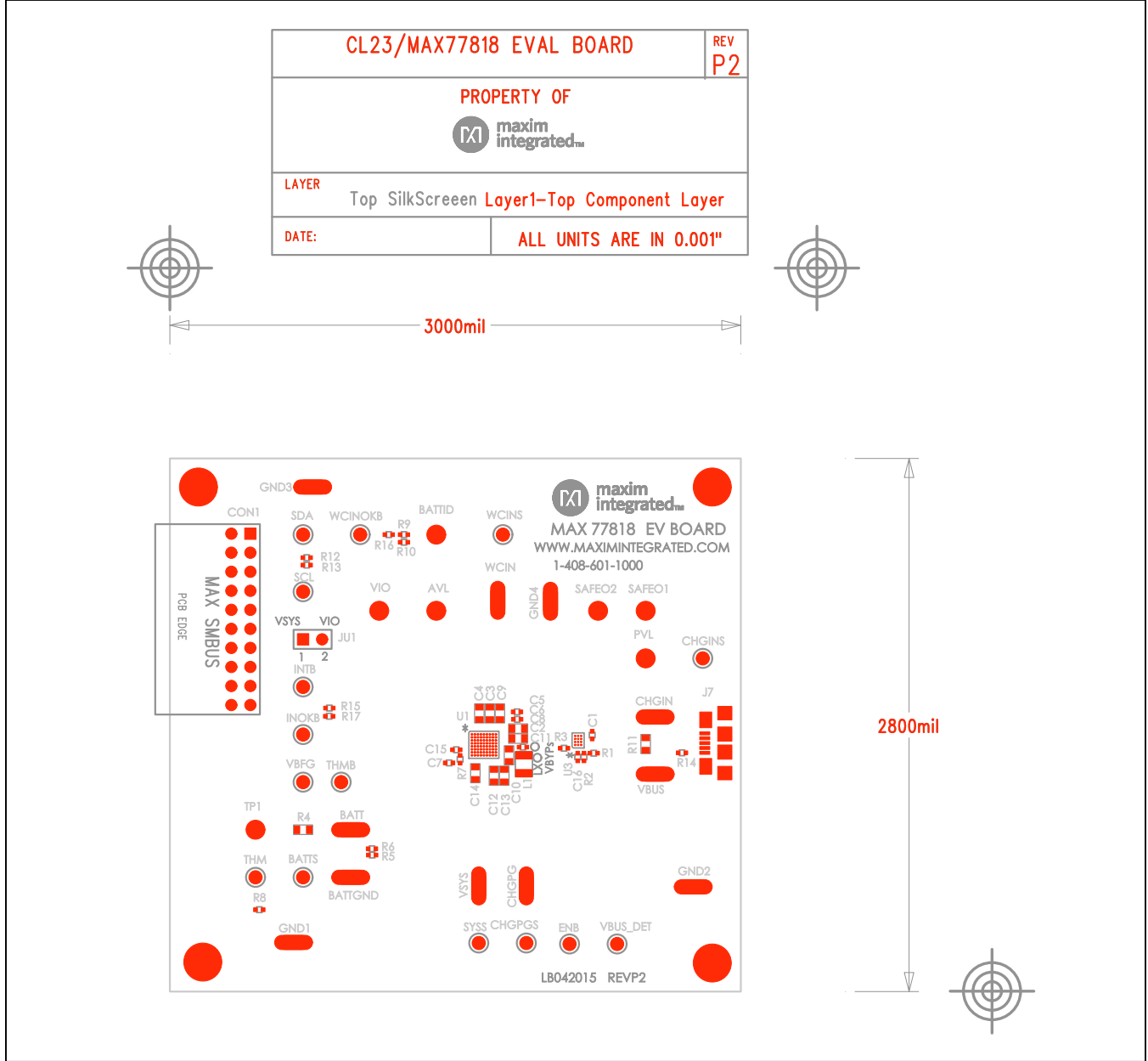

Figure 9. PCB Layout—Assembly Top

Ordering Information

PART	TYPE
MAX77818EVSYS#	EV System

#Denotes RoHS compliant.

Revision History

REVISION NUMBER	REVISION DATE	DESCRIPTION	PAGES CHANGED
0	6/15	Initial release	—
1	8/16	Updated m5 designation, <i>Detailed Description of Software</i> , Figure 3, and <i>Ordering Information</i>	1, 2, 4, 12

For pricing, delivery, and ordering information, please contact Maxim Direct at 1-888-629-4642, or visit Maxim Integrated's website at www.maximintegrated.com.

Maxim Integrated cannot assume responsibility for use of any circuitry other than circuitry entirely embodied in a Maxim Integrated product. No circuit patent licenses are implied. Maxim Integrated reserves the right to change the circuitry and specifications without notice at any time.

Mouser Electronics

Authorized Distributor

Click to View Pricing, Inventory, Delivery & Lifecycle Information:

[Maxim Integrated:](#)

[MAX77818EVSYS#](#)