



Low-Voltage 8:1 Mux/Dual 4:1 Mux/Triple SPDT/ Quad SPDT in UCSP Package

MAX4691-MAX4694

General Description

The MAX4691-MAX4694 are low-voltage CMOS analog ICs configured as an 8-channel multiplexer (MAX4691), two 4-channel multiplexers (MAX4692), three single-pole/double-throw (SPDT) switches (MAX4693), and four SPDT switches (MAX4694).

The MAX4691/MAX4692/MAX4693 operate from either a single +2V to +11V power supply or dual $\pm 2V$ to $\pm 5.5V$ power supplies. When operating from $\pm 5V$ supplies they offer 25Ω on-resistance (R_{ON}), 3.5Ω (max) R_{ON} flatness, and 3Ω (max) matching between channels. The MAX4694 operates from a single +2V to +11V supply. Each switch has rail-to-rail signal handling and a low 1nA leakage current.

All digital inputs are 1.8V logic-compatible when operating from a +3V supply and TTL compatible when operating from a +5V supply.

The MAX4691-MAX4694 are available in 16-pin, 4mm \times 4mm QFN and TQFN and 16-bump UCSP packages. The chip-scale package (UCSP™) occupies a 2mm \times 2mm area, significantly reducing the required PC board area.

Applications

Audio and Video Signal Routing
Cellular Phones
Battery-Operated Equipment
Communications Circuits
Modems

Functional Diagrams

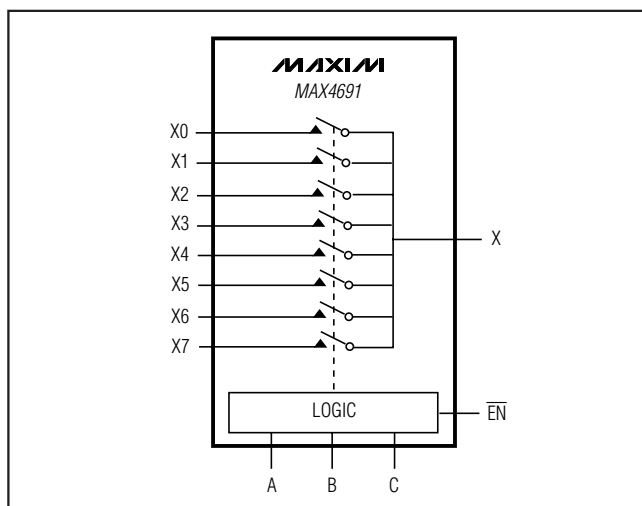

Pin Configurations appear at end of data sheet.

Functional Diagrams continued at end of data sheet.

UCSP is a trademark of Maxim Integrated Products, Inc.

Features

- ◆ 16 Bump, 0.5mm-Pitch UCSP (2mm x 2mm)
- ◆ 1.8V Logic Compatibility
- ◆ Guaranteed On-Resistance
 - 70 Ω (max) with +2.7V Supply
 - 35 Ω (max) with +5V Supply
 - 25 Ω (max) with $\pm 4.5V$ Dual Supplies
- ◆ Guaranteed Match Between Channels
 - 5 Ω (max) with +2.7V Supply
 - 3 Ω (max) with $\pm 4.5V$ Dual Supplies
- ◆ Guaranteed Flatness Over Signal Range
 - 3.5 Ω (max) with $\pm 4.5V$ Dual Supplies
- ◆ Low Leakage Currents Over Temperature
 - 20nA (max) at +85°C
- ◆ Fast 90ns Transition Time
- ◆ Guaranteed Break-Before-Make
- ◆ Single-Supply Operation from +2V to +11V
- ◆ Dual-Supply Operation from $\pm 2V$ to $\pm 5.5V$ (MAX4691/MAX4692/MAX4693)
- ◆ V+ to V- Signal Handling
- ◆ Low Crosstalk: -90dB (100kHz)
- ◆ High Off-Isolation: -88dB (100kHz)

Ordering Information

| PART | TEMP RANGE | PIN-PACKAGE |
|----------------------|----------------|---------------|
| MAX4691 EBE+T | -40°C to +85°C | 16-Bump UCSP* |
| MAX4691EGE+ | -40°C to +85°C | 16 QFN-EP† |
| MAX4691ETE+T | -40°C to +85°C | 16 TQFN-EP† |
| MAX4692 EBE+T | -40°C to +85°C | 16-Bump UCSP* |
| MAX4692EGE+ | -40°C to +85°C | 16 QFN-EP† |
| MAX4692ETE+T | -40°C to +85°C | 16 TQFN-EP† |
| MAX4693 EBE+T | -40°C to +85°C | 16-Bump UCSP* |
| MAX4693EGE+ | -40°C to +85°C | 16 QFN-EP† |
| MAX4693ETE+T | -40°C to +85°C | 16 TQFN-EP† |
| MAX4694 EBE+T | -40°C to +85°C | 16-Bump UCSP* |
| MAX4694EGE+ | -40°C to +85°C | 16 QFN-EP† |
| MAX4694ETE+T | -40°C to +85°C | 16 TQFN-EP† |

*UCSP reliability is integrally linked to the user's assembly methods, circuit board, and environment. See the UCSP Reliability section for more information.

†EP = Exposed pad.

+Denotes a lead(Pb)-free/RoHS-compliant package.

T = Tape and reel.

Low-Voltage 8:1 Mux/Dual 4:1 Mux/Triple SPDT/ Quad SPDT in UCSP Package

ABSOLUTE MAXIMUM RATINGS

V+ to GND-0.3V to +12V
 V+ to V- (MAX4691/MAX4692/MAX4693)-0.3V to +12V
 Voltage into any Terminal (Note 1) (V- - 0.3V) to (V+ + 0.3V)
 Continuous Current into any Terminal ±20mA
 Peak Current W₋, X₋, Y₋, Z₋ (pulsed at 1ms,
 10% duty cycle).....±40mA
 ESD per Method 3015.7.....> 2kV

Continuous Power Dissipation (T_A = +70°C)
 16-Bump UCSP (derate 8.2mW/°C above +70°C) 659mW
 16-Pin QFN (derate 18.5mW/°C above +70°C) 1481mW
 16-Pin TQFN (derate 16.9mW/°C above +70°C) 1349mW
 Operating Temperature Range -40°C to +85°C
 Storage Temperature Range -65°C to +150°C
 Lead Temperature (TQFN, QFN only, soldering, 10s).... +300°C
 Soldering Temperature (reflow) +260°C

Note 1: Voltages exceeding V+ or V- on any signal terminal are clamped by internal diodes. Limit forward-diode current to maximum current rating.

Stresses beyond those listed under "Absolute Maximum Ratings" may cause permanent damage to the device. These are stress ratings only, and functional operation of the device at these or any other conditions beyond those indicated in the operational sections of the specifications is not implied. Exposure to absolute maximum rating conditions for extended periods may affect device reliability.

ELECTRICAL CHARACTERISTICS—Single +3V Supply

(V+ = +2.7V to +3.6V, V- = 0V, V_{IH} = +1.4V, V_{IL} = +0.4V, T_A = -40°C to +85°C, unless otherwise noted. Typical values are at T_A = +25°C.) (Notes 2, 3, 4)

| PARAMETER | SYMBOL | CONDITIONS | T _A | MIN | TYP | MAX | UNITS |
|--|--|---|----------------|-----|-----|-----|-------|
| ANALOG SWITCH | | | | | | | |
| Analog Signal Range | V _W , V _X , V _Y , V _Z , V _{W-} , V _{X-} , V _{Y-} , V _{Z-} | | -40°C to +85°C | 0 | | V+ | V |
| On-Resistance (Note 5) | R _{ON} | V+ = 2.7V; I _W , I _X , I _Y , I _Z = 1mA V _{W-} , V _{X-} , V _{Y-} , V _{Z-} = 1.5V | +25°C | | 45 | 70 | Ω |
| | | | -40°C to +85°C | | | 80 | |
| On-Resistance Match Between Channels (Notes 5, 6) | ΔR _{ON} | V+ = 2.7V; I _W , I _X , I _Y , I _Z = 1mA V _{W-} , V _{X-} , V _{Y-} , V _{Z-} = 1.5V | +25°C | | 2 | 5 | Ω |
| | | | -40°C to +85°C | | | 6 | |
| W ₋ , X ₋ , Y ₋ , Z ₋ Off- Leakage Current (Note 7) | I _{W-} , I _{X-} , I _{Y-} , I _{Z-} | V+ = 3.6V; V _W , V _X , V _Y , V _Z = 3V, 0.6V; V _{W-} , V _{X-} , V _{Y-} , V _{Z-} = 0.6V, 3V | +25°C | -1 | | +1 | nA |
| | | | -40°C to +85°C | -10 | | +10 | |
| W, X, Y, Z Off-Leakage Current (Note 7) | I _{W(OFF)} , I _{X(OFF)} , I _{Y(OFF)} , I _{Z(OFF)} | V+ = 3.6V; V _W , V _X , V _Y , V _Z = 3V, 0.6V; V _{W-} , V _{X-} , V _{Y-} , V _{Z-} = 0.6V, 3V | +25°C | -2 | | +2 | nA |
| | | | -40°C to +85°C | -20 | | +20 | |
| W, X, Y, Z On-Leakage Current (Note 7) | I _{W(ON)} , I _{X(ON)} , I _{Y(ON)} , I _{Z(ON)} | V+ = 3.6V; V _W , V _X , V _Y , V _Z = 0.6V, 3V; V _{W-} , V _{X-} , V _{Y-} , V _{Z-} = 0.6V, 3V, or unconnected | +25°C | -2 | | +2 | nA |
| | | | -40°C to +85°C | -20 | | +20 | |

Low-Voltage 8:1 Mux/Dual 4:1 Mux/Triple SPDT/ Quad SPDT in UCSP Package

ELECTRICAL CHARACTERISTICS—Single +3V Supply (continued)

(V+ = +2.7V to +3.6V, V- = 0V, VIH = +1.4V, VIL = +0.4V, TA = -40°C to +85°C, unless otherwise noted. Typical values are at TA = +25°C.) (Notes 2, 3, 4)

| PARAMETER | SYMBOL | CONDITIONS | TA | MIN | TYP | MAX | UNITS |
|---|---|--|----------------|-------|-----|-----|-------|
| Input Off-Capacitance | CW(OFF), CX(OFF), CY(OFF), CZ(OFF) | f = 1MHz, Figure 7 | +25°C | | 9 | | pF |
| Output Off-Capacitance | CX(OFF), CY(OFF), CZ(OFF) | f = 1MHz, Figure 7 | MAX4691 | +25°C | 68 | | pF |
| | | | MAX4692 | | 36 | | |
| | | | MAX4693 | | 20 | | |
| On-Capacitance | CW(ON), CX(ON), CY(ON), CZ(ON) | f = 1MHz, Figure 7 | MAX4691 | +25°C | 78 | | pF |
| | | | MAX4692 | | 46 | | |
| | | | MAX4693 | | 30 | | |
| DYNAMIC | | | | | | | |
| Enable Turn-On Time (MAX4691/MAX4692/ MAX4693) | tON | VW-, VX-, VY-, VZ- = 1.5V; RL = 300Ω, CL = 35pF, Figure 2 | +25°C | 180 | 300 | | ns |
| | | | -40°C to +85°C | | 350 | | |
| Enable Turn-Off Time (MAX4691/MAX4692/ MAX4693) | tOFF | VW-, VX-, VY-, VZ- = 1.5V; RL = 300Ω, CL = 35pF, Figure 2 | +25°C | 70 | 100 | | ns |
| | | | -40°C to +85°C | | 120 | | |
| Address Transition Time | tTRANS | VW-, VX-, VY-, VZ- = 0V, 1.5V; RL = 300Ω, CL = 35pF, Figure 3 | +25°C | 200 | 350 | | ns |
| | | | -40°C to +85°C | | 400 | | |
| Break-Before-Make | tBBM | VW-, VX-, VY-, VZ- = 1.5V; RL = 300Ω, CL = 35pF, Figure 4 | +25°C | 2 | 90 | | ns |
| | | | -40°C to +85°C | 2 | | | |
| Charge Injection | Q | VGEN = 0V; RGEN = 0Ω; CL = 1nF, Figure 5 | +25°C | | 0.1 | | pC |
| Off-Isolation (Note 8) | VISO | f = 0.1MHz, RL = 50Ω, CL = 5pF, Figure 6 | +25°C | | -70 | | dB |
| Crosstalk (Note 9) | VCT | f = 0.1MHz, RL = 50Ω, CL = 5pF, Figure 6 | +25°C | | -75 | | dB |
| DIGITAL I/O | | | | | | | |
| Input Logic-High | VIH | | | 1.4 | | | V |
| Input Logic-Low | VIL | | | | | 0.4 | V |
| Input Leakage Current | IIN | VA, VB, VC, VEN = 0V or V+ | | -1 | | +1 | μA |
| SUPPLY | | | | | | | |
| Positive Supply Current | I+ | V+ = 3.6V, VA, VB, VC, VEN = 0V or V+ | +25°C | | 0.1 | | μA |
| | | | -40°C to +85°C | | 1 | | |

Low-Voltage 8:1 Mux/Dual 4:1 Mux/Triple SPDT/ Quad SPDT in UCSP Package

ELECTRICAL CHARACTERISTICS—Single +5V Supply

(V+ = +4.5V to +5.5V, V- = 0V, VIH = +2V, VIL = +0.8V, TA = -40°C to +85°C, unless otherwise noted. Typical values are at TA = +25°C.) (Notes 2, 3, 4)

| PARAMETER | SYMBOL | CONDITIONS | TA | MIN | TYP | MAX | UNITS |
|---|---|--|----------------|-----|-----|-----|-------|
| ANALOG SWITCH | | | | | | | |
| Analog Signal Range | VW, VX, VY, VZ, VW-, VX-, VY-, VZ- | | -40°C to +85°C | 0 | | V+ | V |
| On-Resistance (Note 5) | RON | V+ = 4.5V; IW, IX, IY, IZ = 1mA; VW-, VX-, VY-, VZ- = 3.5V | +25°C | | 25 | 35 | Ω |
| | | | -40°C to +85°C | | | 40 | |
| On-Resistance Match Between Channels (Notes 5, 6) | ΔRON | V+ = 4.5V; IW, IX, IY, IZ = 1mA; VW-, VX-, VY-, VZ- = 3.5V | +25°C | | 2 | 4 | Ω |
| | | | -40°C to +85°C | | | 5 | |
| On-Resistance Flatness (Note 10) | RFLAT(ON) | V+ = 4.5V; IW, IX, IY, IZ = 1mA; VW-, VX-, VY-, VZ- = 1V, 2.25V, 3.5V | +25°C | | 2 | 6 | Ω |
| | | | -40°C to +85°C | | | 8 | |
| W-, X-, Y-, Z- Off-Leakage Current (Note 7) | IW-, IX-, IY-, IZ- | V+ = 5.5V; VW, VX, VY, VZ = 4.5V, 1V-; VW-, VX-, VY-, VZ- = 1V, 4.5V | +25°C | -1 | | +1 | nA |
| | | | -40°C to +85°C | -10 | | +10 | |
| W, X, Y, Z Off-Leakage Current (Note 7) | IW(OFF), IX(OFF), IY(OFF), IZ(OFF) | V+ = 5.5V; VW, VX, VY, VZ = 4.5V, 1V-; VW-, VX-, VY-, VZ- = 1V, 4.5V | +25°C | -2 | | +2 | nA |
| | | | -40°C to +85°C | -20 | | +20 | |
| W, X, Y, Z On-Leakage Current (Note 7) | IW(ON), IX(ON), IY(ON), IZ(ON) | V+ = 5.5V; VW, VX, VY, VZ = 1V, 4.5V-; VW-, VX-, VY-, VZ- = 1V, 4.5V, or unconnected | +25°C | -2 | | +2 | nA |
| | | | -40°C to +85°C | -20 | | +20 | |
| DYNAMIC | | | | | | | |
| Enable Turn-On Time (MAX4691/MAX4692/MAX4693) | tON | VW-, VX-, VY-, VZ- = 3V; RL = 300Ω, CL = 35pF, Figure 2 | +25°C | | 90 | 130 | ns |
| | | | -40°C to +85°C | | | 150 | |
| Enable Turn-Off Time (MAX4691/MAX4692/MAX4693) | tOFF | VW-, VX-, VY-, VZ- = 3V; RL = 300Ω, CL = 35pF, Figure 2 | +25°C | | 45 | 60 | ns |
| | | | -40°C to +85°C | | | 70 | |
| Address Transition Time | tTRANS | VW-, VX-, VY-, VZ- = 0V, 3V; RL = 300Ω, CL = 35pF, Figure 3 | +25°C | | 100 | 140 | ns |
| | | | -40°C to +85°C | | | 160 | |
| Break-Before-Make | tBBM | VW-, VX-, VY-, VZ- = 3V; RL = 300Ω, CL = 35pF, Figure 4 | +25°C | 2 | 35 | | ns |
| | | | -40°C to +85°C | 2 | | | |
| Charge Injection | Q | VGEN = 0V; RGEN = 0Ω; CL = 1nF, Figure 5 | +25°C | | 0.2 | | pC |

Low-Voltage 8:1 Mux/Dual 4:1 Mux/Triple SPDT/ Quad SPDT in UCSP Package

ELECTRICAL CHARACTERISTICS—Single +5V Supply (continued)

(V+ = +4.5V to +5.5V, V- = 0V, VIH = +2V, VIL = +0.8V, TA = -40°C to +85°C, unless otherwise noted. Typical values are at TA = +25°C.) (Notes 2, 3, 4)

| PARAMETER | SYMBOL | CONDITIONS | TA | MIN | TYP | MAX | UNITS |
|-------------------------|----------------------|--|----------------|-----|-----|-----|-------|
| Off-Isolation (Note 8) | VISO | f = 0.1MHz, RL = 50Ω, CL = 5pF Figure 6 | +25°C | | -80 | | dB |
| Crosstalk (Note 9) | VCT | f = 0.1MHz, RL = 50Ω, CL = 5pF Figure 6 | +25°C | | -87 | | dB |
| DIGITAL I/O | | | | | | | |
| Input Logic-High | VIH | | | 2 | | | V |
| Input Logic-Low | VIL | | | | | 0.8 | V |
| Input Leakage Current | I _{LEAKAGE} | VIN_ = 0V or V+ | | -1 | | +1 | μA |
| SUPPLY | | | | | | | |
| Positive Supply Current | I+ | V+ = 5.5V; VIN_ = 0V or V+ | +25°C | | | 0.1 | μA |
| | | | -40°C to +85°C | -1 | | 1 | |

ELECTRICAL CHARACTERISTICS—Dual ±5V Supplies (MAX4691/MAX4692/MAX4693 only)

(V+ = +4.5V to +5.5V, V- = -4.5V to -5.5V, VIH = +2V, VIL = +0.8V, TA = -40°C to +85°C, unless otherwise noted.) (Notes 2, 3, 4)

| PARAMETER | SYMBOL | CONDITIONS | TA | MIN | TYP | MAX | UNITS |
|---|---------------------------------|--|----------------|-----|-----|-----|-------|
| ANALOG SWITCH | | | | | | | |
| Analog Signal Range | VX, VY, VZ, VX-, VY-, VZ- | | -40°C to +85°C | V- | | V+ | V |
| On-Resistance (Note 5) | RON | V+ = 4.5V; IX, IY, IZ = 10mA; V- = -4.5V; VX-, VY-, VZ- = 3.5V | +25°C | | 18 | 25 | Ω |
| | | | -40°C to +85°C | | | 30 | |
| On-Resistance Match Between Channels (Notes 5, 6) | ΔRON | V+ = 4.5V; V- = -4.5V; IX, IY, IZ = 10mA; VX-, VY-, VZ- = 3.5V | +25°C | | 2 | 3 | Ω |
| | | | -40°C to +85°C | | | 4 | |
| On-Resistance Flatness (Note 10) | RFLAT(ON) | V+ = 4.5V; V- = -4.5V; IX, IY, IZ = 10mA; VX, VY, VZ = 3.5V, 0V, -3.5V | +25°C | | 2.5 | 3.5 | Ω |
| | | | -40°C to +85°C | | | 4 | |
| X-, Y-, Z- Off-Leakage Current (Note 7) | IX-, IY-, IZ- | V+ = 5.5V; V- = -5.5V; VX, VY, VZ = +4.5V; VX-, VY-, VZ- = ±4.5V | +25°C | -1 | | +1 | nA |
| | | | -40°C to +85°C | -10 | | +10 | |
| X, Y, Z Off-Leakage Current (Note 7) | IX(OFF), IY(OFF), IZ(OFF) | V+ = 5.5V; V- = -5.5V; VX, VY, VZ = +4.5V; VX-, VY-, VZ- = ±4.5V | +25°C | -2 | | +2 | nA |
| | | | -40°C to +85°C | -20 | | +20 | |

Low-Voltage 8:1 Mux/Dual 4:1 Mux/Triple SPDT/ Quad SPDT in UCSP Package

ELECTRICAL CHARACTERISTICS—Dual $\pm 5V$ Supplies (continued) (MAX4691/MAX4692/MAX4693 only)

($V_+ = +4.5V$ to $+5.5V$, $V_- = -4.5V$ to $-5.5V$, $V_{IH} = +2V$, $V_{IL} = +0.8V$, $T_A = -40^\circ C$ to $+85^\circ C$, unless otherwise noted.) (Notes 2, 3, 4)

| PARAMETER | SYMBOL | CONDITIONS | T_A | MIN | TYP | MAX | UNITS |
|--|---|---|--------------------------------|-----|------|-----|---------|
| X, Y, Z On-Leakage Current (Note 7) | $I_{X(ON)}$, $I_{Y(ON)}$, $I_{Z(ON)}$ | $V_+ = 5.5V$; $V_- = -5.5V$; $V_X, V_Y, V_Z = \pm 4.5V$; $V_{X-}, V_{Y-}, V_{Z-} = \pm 4.5V$, or unconnected | $+25^\circ C$ | -2 | | 2 | nA |
| | | | $-40^\circ C$ to $+85^\circ C$ | -20 | | 20 | |
| DYNAMIC | | | | | | | |
| Enable Turn-On Time | t_{ON} | $V_{X-}, V_{Y-}, V_{Z-} = 3V$; $R_L = 300\Omega$, $C_L = 35pF$, Figure 2 | $+25^\circ C$ | | 55 | 80 | ns |
| | | | $-40^\circ C$ to $+85^\circ C$ | | | 90 | |
| Enable Turn-Off Time | t_{OFF} | $V_{X-}, V_{Y-}, V_{Z-} = 3V$; $R_L = 300\Omega$, $C_L = 35pF$, Figure 2 | $+25^\circ C$ | | 35 | 50 | ns |
| | | | $-40^\circ C$ to $+85^\circ C$ | | | 60 | |
| Address Transition Time | t_{TRANS} | $V_{X-}, V_{Y-}, V_{Z-} = 0V, 3V$; $R_L = 300\Omega$, $C_L = 35pF$, Figure 3 | $+25^\circ C$ | | 60 | 90 | ns |
| | | | $-40^\circ C$ to $+85^\circ C$ | | | 100 | |
| Break-Before-Make | t_{BBM} | $V_{X-}, V_{Y-}, V_{Z-} = 3V$; $R_L = 300\Omega$, $C_L = 35pF$, Figure 4 | $+25^\circ C$ | 2 | 20 | | ns |
| | | | $-40^\circ C$ to $+85^\circ C$ | 2 | | | |
| Charge Injection | Q | $V_{GEN} = 0V$; $R_{GEN} = 0\Omega$; $C_L = 1nF$, Figure 5 | $+25^\circ C$ | | 1.8 | | pC |
| Off-Isolation (Note 8) | V_{ISO} | $f = 0.1MHz$, $R_L = 50\Omega$, $C_L = 5pF$, Figure 6 | $+25^\circ C$ | | -82 | | dB |
| Crosstalk (Note 9) | V_{CT} | $f = 0.1MHz$, $R_L = 50\Omega$, $C_L = 5pF$, Figure 7 | $+25^\circ C$ | | -84 | | dB |
| Total Harmonic Distortion | THD | $f = 20Hz$ to $20kHz$, $V_X, V_Y, V_Z =$ $5V_{p-p}$; $R_L = 600\Omega$, | $+25^\circ C$ | | 0.02 | | % |
| DIGITAL I/O | | | | | | | |
| Input Logic-High | V_{IH} | | | 2 | | | V |
| Input Logic-Low | V_{IL} | | | | | 0.8 | V |
| Input Leakage Current | I_{IN} | $V_A, V_B, V_C, V_{EN} = 0V$ or V_+ | | -1 | | +1 | μA |
| SUPPLY | | | | | | | |
| Positive Supply Current | I_+ | $V_+ = 5.5V$; $V_- = 5.5V$; $V_A, V_B, V_C, V_{EN} = 0V$ or V_+ | $+25^\circ C$ | | | 0.1 | μA |
| | | | $-40^\circ C$ to $+85^\circ C$ | | | 1 | |

Note 2: The algebraic convention, where the most negative value is a minimum and the most positive value is a maximum, is used in this data sheet.

Note 3: UCSP parts are 100% tested at $T_A = +25^\circ C$. Limits across the full temperature range are guaranteed by correlation.

Note 4: QFN and TQFN parts are 100% tested at $T_A = +85^\circ C$. Limits across the full temperature range are guaranteed by correlation.

Note 5: UCSP R_{ON} and R_{ON} match are guaranteed by design.

Note 6: $\Delta R_{ON} = R_{ON(MAX)} - R_{ON(MIN)}$.

Note 7: Leakage parameters are guaranteed by design.

Note 8: Off-isolation = $20 \log_{10} (V_{W,X,Y,Z} / V_{W,X-,Y-,Z-})$, $V_{W,X,Y,Z}$ = output, $V_{W,X-,Y-,Z-}$ = input to off switch.

Note 9: Between any two switches.

Note 10: Flatness is defined as the difference between the maximum and minimum value of on-resistance as measured over the specified analog signal ranges.

Low-Voltage 8:1 Mux/Dual 4:1 Mux/Triple SPDT/Quad SPDT in UCSP Package

Typical Operating Characteristics

($T_A = +25^\circ\text{C}$, unless otherwise noted.)

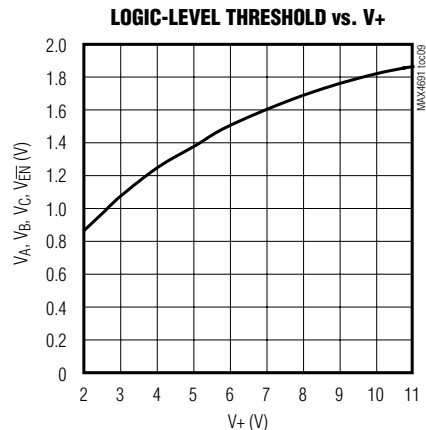
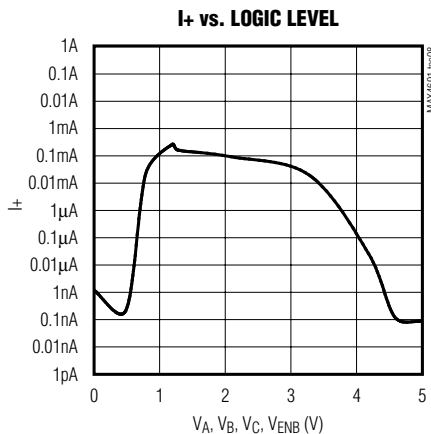
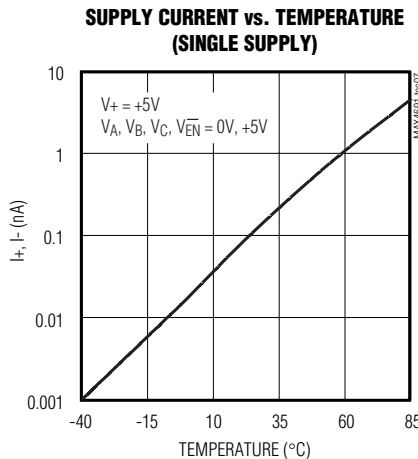
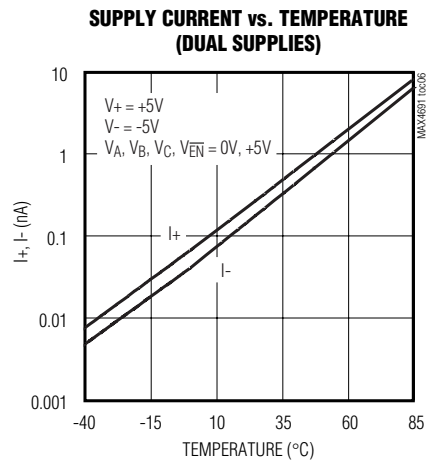
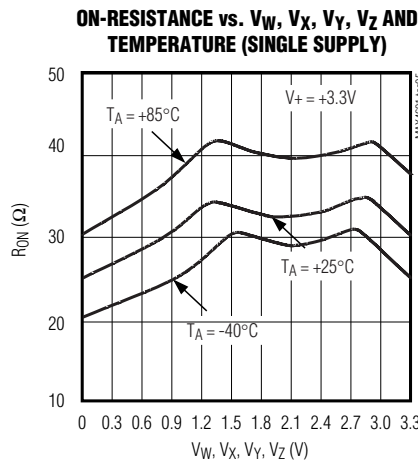
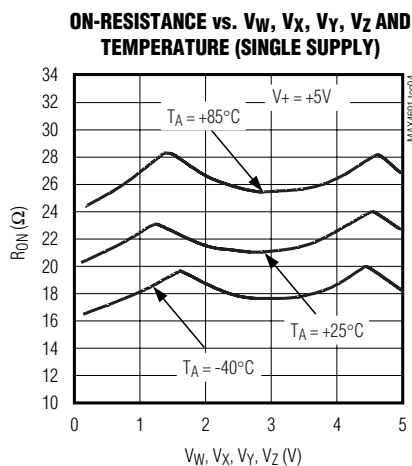
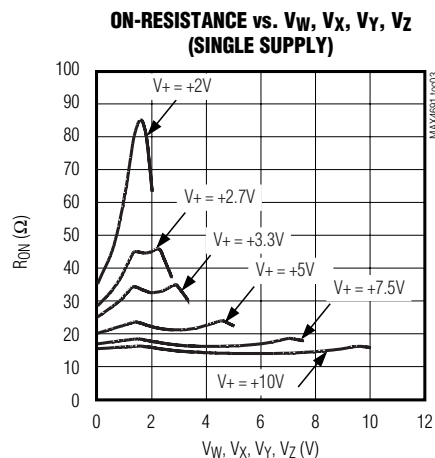
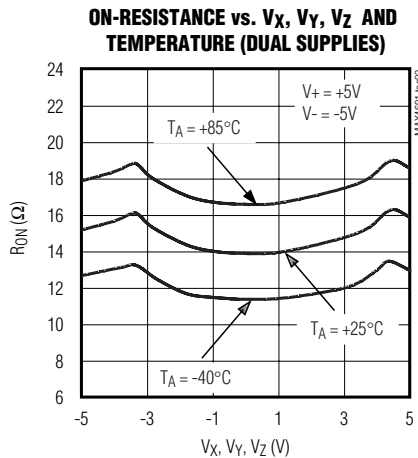
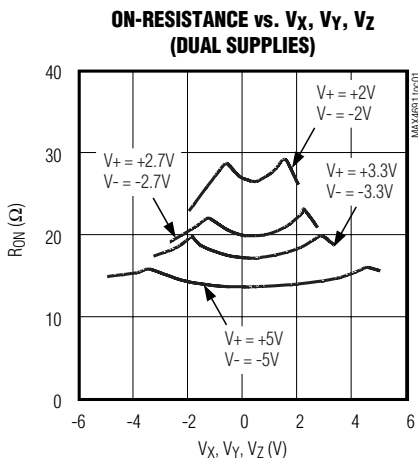

Low-Voltage 8:1 Mux/Dual 4:1 Mux/Triple SPDT/Quad SPDT in UCSP Package

Typical Operating Characteristics (continued)

($T_A = +25^\circ\text{C}$, unless otherwise noted.)

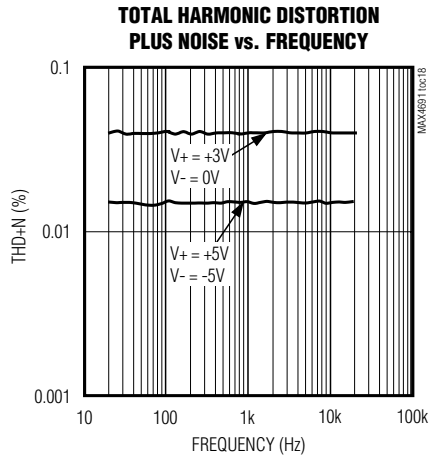
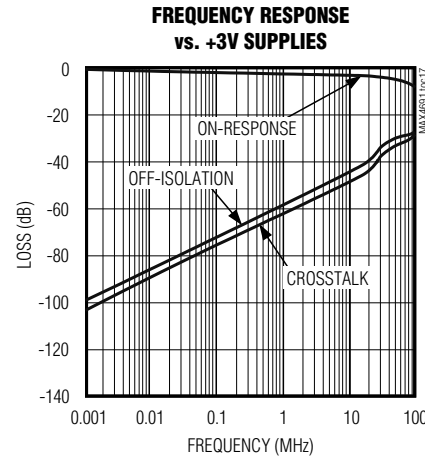
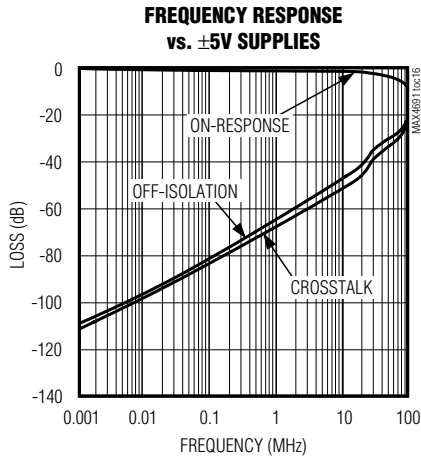
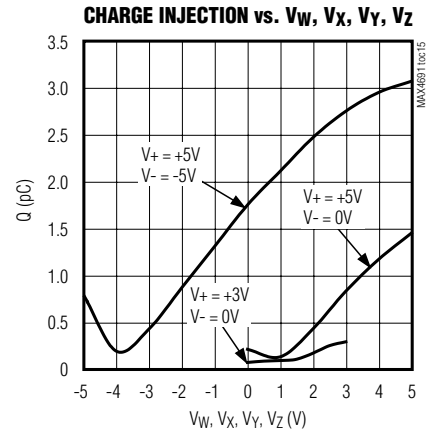
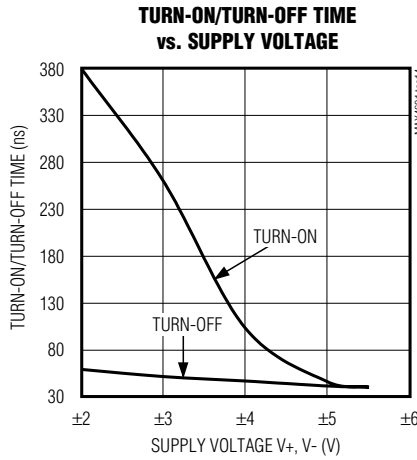
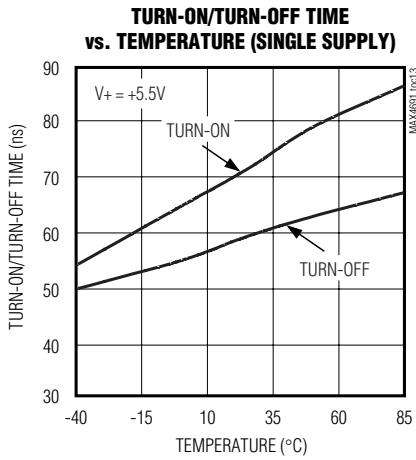
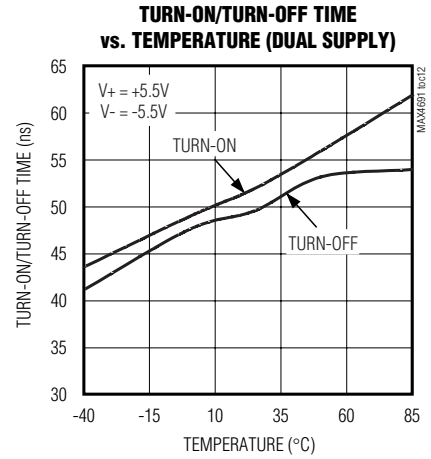
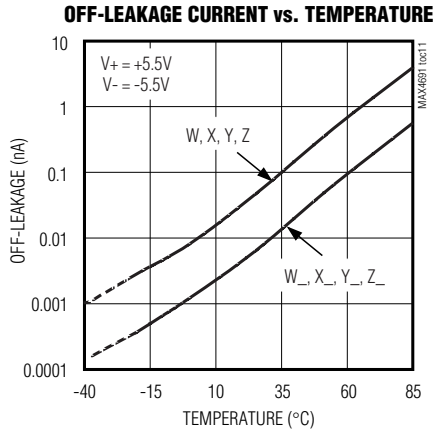
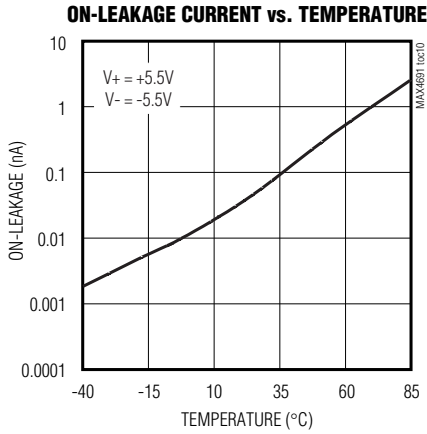

Low-Voltage 8:1 Mux/Dual 4:1 Mux/Triple SPDT/ Quad SPDT in UCSP Package

Pin Description

MAX4691

| PIN | | NAME | FUNCTION |
|--------------------------------------|------------------------------|-----------------|---|
| UCSP | QFN-EP/ TQFN-EP | | |
| A4, B4, C4, D4, A1, B1, C1, D1 | 16, 1, 3, 4, 12, 11, 9, 8 | X0–X7 | Analog Switch Inputs 0–7 |
| A2 | 13 | X | Analog Switch Common |
| D3, D2, A3 | 5, 7, 15 | A, B, C | Digital Address Inputs |
| B2 | 14 | V- | Negative Analog Supply Voltage Input. Connect V- to GND for single-supply operation. |
| B3 | 2 | GND | Ground. Connect to digital ground. (Analog signals have no ground reference; they are limited to V+ and V-.) |
| C2 | 10 | \overline{EN} | Digital Enable Input. Normally connect \overline{EN} to GND. \overline{EN} can be driven to logic high to set all switches off. |
| C3 | 6 | V+ | Positive Analog and Digital Supply Voltage Input |
| — | — | EP | Exposed Pad (QFN and TQFN only). Connect EP to V+. |

MAX4692

| PIN | | NAME | FUNCTION |
|-------------------|--------------------|-----------------|---|
| UCSP | QFN-EP/ TQFN-EP | | |
| A1, B1, C1, D1 | 12, 11, 9, 8 | X0–X3 | Analog Switch “X” Inputs 0–3 |
| A4, B4, C4, D4 | 16, 1, 3, 4 | Y0–Y3 | Analog Switch “Y” Inputs 0–3 |
| A2 | 13 | X | Analog Switch “X” Common |
| A3 | 15 | Y | Analog Switch “Y” Common |
| D3, D2 | 5, 7 | A, B | Digital Address Inputs for both “X” and “Y” Analog Switches |
| B2 | 14 | V- | Negative Analog Supply Voltage Input. Connect V- to GND for single-supply |
| B3 | 2 | GND | Ground. Connect to digital ground. (Analog signals have no ground reference; they are limited to V+ and V-.) |
| C2 | 10 | \overline{EN} | Digital Enable Input. Normally connect \overline{EN} to GND. \overline{EN} can be driven to logic high to set all switches off. |
| C3 | 6 | V+ | Positive Analog and Digital Supply Voltage Input |
| — | — | EP | Exposed Pad (QFN and TQFN only). Connect EP to V+. |

MAX4691-MAX4694

Low-Voltage 8:1 Mux/Dual 4:1 Mux/Triple SPDT/ Quad SPDT in UCSP Package

Pin Description (continued)

MAX4693

| PIN | | NAME | FUNCTION |
|------|--------------------|------------------------|---|
| UCSP | QFN-EP/ TQFN-EP | | |
| A1 | 12 | X0 | Analog Switch "X" Normally Closed Input |
| B1 | 11 | X1 | Analog Switch "X" Normally Open Input |
| A4 | 16 | Y0 | Analog Switch "Y" Normally Closed Input |
| B4 | 1 | Y1 | Analog Switch "Y" Normally Open Input |
| D1 | 8 | Z0 | Analog Switch "Z" Normally Closed Input |
| C1 | 9 | Z1 | Analog Switch "Z" Normally Open Input |
| A2 | 13 | X | Analog Switch "X" Common |
| A3 | 15 | Y | Analog Switch "Y" Common |
| D2 | 7 | Z | Analog Switch "Z" Common |
| C4 | 3 | A | Analog Switch "X" Digital Control Input |
| D4 | 4 | B | Analog Switch "Y" Digital Control Input |
| D3 | 5 | C | Analog Switch "Z" Digital Control Input |
| B2 | 14 | V- | Negative Analog Supply Voltage Input. Connect V- to GND for single-supply operation. |
| B3 | 2 | GND | Ground. Connect GND to digital ground. (Analog signals have no ground reference; they are limited to V+ and V-.) |
| C2 | 10 | $\overline{\text{EN}}$ | Digital Enable Input. Normally connect $\overline{\text{EN}}$ to GND. $\overline{\text{EN}}$ can be driven to logic high to set all switches off. |
| C3 | 6 | V+ | Positive Analog and Digital Supply Voltage Input |
| — | — | EP | Exposed Pad (QFN and TQFN only). Connect EP to V+. |

Low-Voltage 8:1 Mux/Dual 4:1 Mux/Triple SPDT/ Quad SPDT in UCSP Package

Pin Description (continued)

MAX4694

| PIN | | NAME | FUNCTION |
|------|--------------------|------|--|
| USCP | QFN-EP/ TQFN-EP | | |
| D4 | 4 | W0 | Analog Switch "W" Normally Closed Input |
| C4 | 3 | W1 | Analog Switch "W" Normally Open Input |
| A1 | 12 | X0 | Analog Switch "X" Normally Closed Input |
| B1 | 11 | X1 | Analog Switch "X" Normally Open Input |
| A4 | 16 | Y0 | Analog Switch "Y" Normally Closed Input |
| B4 | 1 | Y1 | Analog Switch "Y" Normally Open Input |
| D1 | 8 | Z0 | Analog Switch "Z" Normally Closed Input |
| C1 | 9 | Z1 | Analog Switch "Z" Normally Open Input |
| D3 | 5 | W | Analog Switch "W" Common |
| A2 | 13 | X | Analog Switch "X" Common |
| A3 | 15 | Y | Analog Switch "Y" Common |
| D2 | 7 | Z | Analog Switch "Z" Common |
| B2 | 14 | GND | Ground |
| B3 | 2 | A | Analog Switch "W" and "Y" Digital Control Input |
| C2 | 10 | B | Analog Switch "X" and "Z" Digital Control Input |
| C3 | 6 | V+ | Positive Analog and Digital Supply Voltage Input |
| — | — | EP | Exposed Pad (QFN and TQFN only). Connect EP to V+. |

MAX4691-MAX4694

Low-Voltage 8:1 Mux/Dual 4:1 Mux/Triple SPDT/ Quad SPDT in UCSP Package

Table 1. Truth Table/Switch Programming

| $\overline{\text{EN}}^1$ | ADDRESS BITS | | | ON SWITCHES | | | |
|--------------------------|----------------|---|---|-------------------|-------------------|-------------------|---------------------------|
| | C ² | B | A | MAX4691 | MAX4692 | MAX4693 | MAX4694 |
| 1 | X | X | X | All switches open | All switches open | All switches open | — |
| 0 | 0 | 0 | 0 | X-X0 | X-X0, Y-Y0 | X-X0, Y-Y0, Z-Z0 | W-W0, X-X0, Y-Y0, Z-Z0 |
| 0 | 0 | 0 | 1 | X-X1 | X-X1, Y-Y1 | X-X1, Y-Y0, Z-Z0 | W-W1, X-X0, Y-Y1, Z-Z0 |
| 0 | 0 | 1 | 0 | X-X2 | X-X2, Y-Y2 | X-X0, Y-Y1, Z-Z0 | W-W0, X-X1, Y-Y0, Z-Z1 |
| 0 | 0 | 1 | 1 | X-X3 | X-X3, Y-Y3 | X-X1, Y-Y1, Z-Z0 | W-W1, X-X1, Y-Y1, Z-Z1 |
| 0 | 1 | 0 | 0 | X-X4 | X-X0, Y-Y0 | X-X0, Y-Y0, Z-Z1 | W-W0, X-X0, Y-Y0, Z-Z0 |
| 0 | 1 | 0 | 1 | X-X5 | X-X1, Y-Y1 | X-X1, Y-Y0, Z-Z1 | W-W1, X-X0, Y-Y1, Z-Z0 |
| 0 | 1 | 1 | 0 | X-X6 | X-X2, Y-Y2 | X-X0, Y-Y1, Z-Z1 | W-W0, X-X1, Y-Y0, Z-Z1 |
| 0 | 1 | 1 | 1 | X-X7 | X-X3, Y-Y3 | X-X1, Y-Y1, Z-Z1 | W-W1, X-X1, Y-Y1, Z-Z1 |

X = Don't care

1. EN is not present on the MAX4694.

2. C²s not present on the MAX4692 and MAX4694.

Detailed Description

The MAX4691–MAX4694 are low-voltage CMOS analog ICs configured as an 8-channel multiplexer (MAX4691), two 4-channel multiplexers (MAX4692), three SPDT switches (MAX4693), and four SPDT switches (MAX4694). All switches are bidirectional.

The MAX4691/MAX4692/MAX4693 operate from either a single +2V to +11V power supply or dual $\pm 2V$ to $\pm 5.5V$ power supplies. When operating from $\pm 5V$ supplies they offer 25 Ω on-resistance (R_{ON}), 3.5 Ω max R_{ON} flatness, and 3 Ω max matching between channels. The MAX4694 operates from a single +2V to +11V supply. Each switch has rail-to-rail signal handling, fast switching times of $t_{ON} = 80ns$, $t_{OFF} = 50ns$, and a low 1nA leakage current.

All digital inputs are 1.8V logic-compatible when operating from a +3V supply and TTL-compatible when operating from a +5V supply.

Digital Inputs

The MAX4691 and MAX4692 include address pins that allow control of the multiplexers. For the MAX4691, pins

A, B, C determine which switch is closed. The two 4-1 muxes in the MAX4692 are controlled by the same address pins (A and B). (Table 1)

The MAX4693 and MAX4694 offer SPDT switches in triple and quadruple packages. In the MAX4693, each switch has a unique control input. The MAX4694 has two digital control inputs: A (for switches “W” and “Y”) and B (for switches “X” and “Z”). (Table 1)

Applications Information

Power-Supply Considerations

Overview

The MAX4691–MAX4694 construction is typical of most CMOS analog switches. V⁺ and V⁻ are used to drive the internal CMOS switches and set the limits of the analog voltage on any switch. Reverse ESD-protection diodes are internally connected between each analog signal pin and both V⁺ and V⁻. If any analog signal exceeds V⁺ or V⁻, one of these diodes will conduct.

*V⁻ is found only on the MAX4691/MAX4692/MAX4693.

Low-Voltage 8:1 Mux/Dual 4:1 Mux/Triple SPDT/Quad SPDT in UCSP Package

During normal operation, these (and other) reverse-biased ESD diodes leak, forming the only current drawn from V+ or V-.

Virtually all the analog leakage current comes from the ESD diodes. Although the ESD diodes on a given signal pin are identical, and therefore fairly well balanced, they are reverse biased differently. Each is biased by either V+ or V- and the analog signal. This means their leakages will vary as the signal varies. The *difference* in the two diode leakages to the V+ and V- pins constitutes the analog signal path leakage current. All analog leakage current flows between each pin and one of the supply terminals, not to the other switch terminal. This is why both sides of a given switch can show leakage currents of either the same or opposite polarity.

V+ and GND power the internal logic and logic-level translators, and set both the input and output logic limits. The logic-level translators convert the logic levels into switched V+ and V- signals to drive the gates of the analog signals. This drive signal is the only connection between the logic supplies (and signals) and the analog supplies. V+ and V- have ESD-protection diodes on GND.

Bipolar Supplies

The MAX4691/MAX4692/MAX4693 operate with bipolar supplies between $\pm 2V$ and $\pm 5.5V$. The V+ and V- supplies need not be symmetrical, but their difference cannot exceed the absolute maximum rating of +12V.

Single Supply

These devices operate from a single supply between +2V and +11V when V- is connected to GND. All of the bipolar precautions must be observed. At room temperature, they operate with a single supply at near or below +2V, although as supply voltage decreases, switch on-resistance and switching times become very high.

Always bypass supplies with a 0.1 μ F capacitor.

Overvoltage Protection

Proper power-supply sequencing is recommended for all CMOS devices. Do not exceed the absolute maximum ratings, because stresses beyond the listed ratings can cause permanent damage to the devices. Always sequence V+ on first, then V-, followed by the logic inputs and by W, X, Y, Z. If power-supply sequencing is not possible, add two small signal diodes (D1, D2) in series with the supply pins for overvoltage protection (Figure 1).

Adding diodes reduces the analog signal range to one diode drop below V+ and one diode drop above V-, but does not affect the devices' low switch resistance and low leakage characteristics. Device operation is

unchanged, and the difference between V+ and V- should not exceed 12V. These protection diodes are not recommended when using a single supply if signal levels must extend to ground.

UCSP Reliability

The chip-scale package (UCSP) represents a unique package that greatly reduces board space compared to other packages. UCSP reliability is integrally linked to the user's assembly methods, circuit board material, and usage environment. The user should closely review these areas when considering a UCSP. Performance through Operating Life Test and Moisture Resistance is equal to conventional package technology as it is primarily determined by the wafer-fabrication process. However, this form factor may not perform equally to a packaged product through traditional mechanical reliability tests.

Mechanical stress performance is a greater consideration for a UCSP. UCSP solder joint contact integrity must be considered since the package is attached through direct solder contact to the user's PC board. Testing done to characterize the UCSP reliability performance shows that it is capable of performing reliably through environmental stresses. Results of environmental stress tests and additional usage data and recommendations are detailed in the UCSP application note, which can be found on Maxim's website, at www.maxim-ic.com.

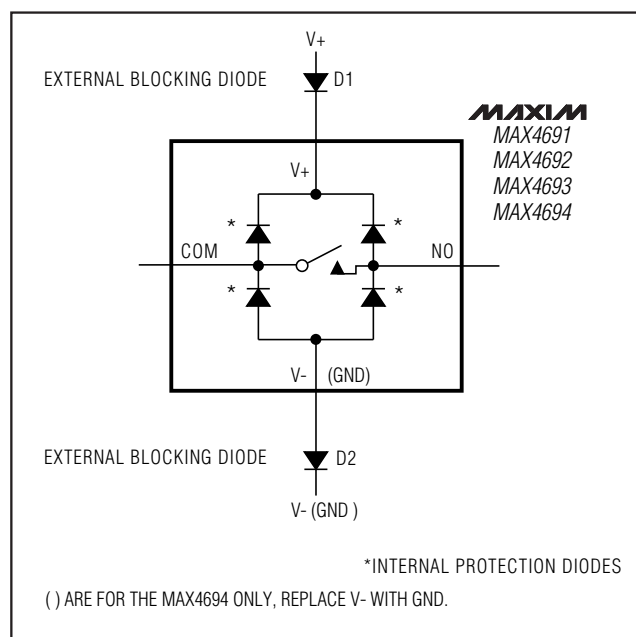

Figure 1. Overvoltage Protection

Low-Voltage 8:1 Mux/Dual 4:1 Mux/Triple SPDT/ Quad SPDT in UCSP Package

Test Circuits/Timing Diagrams

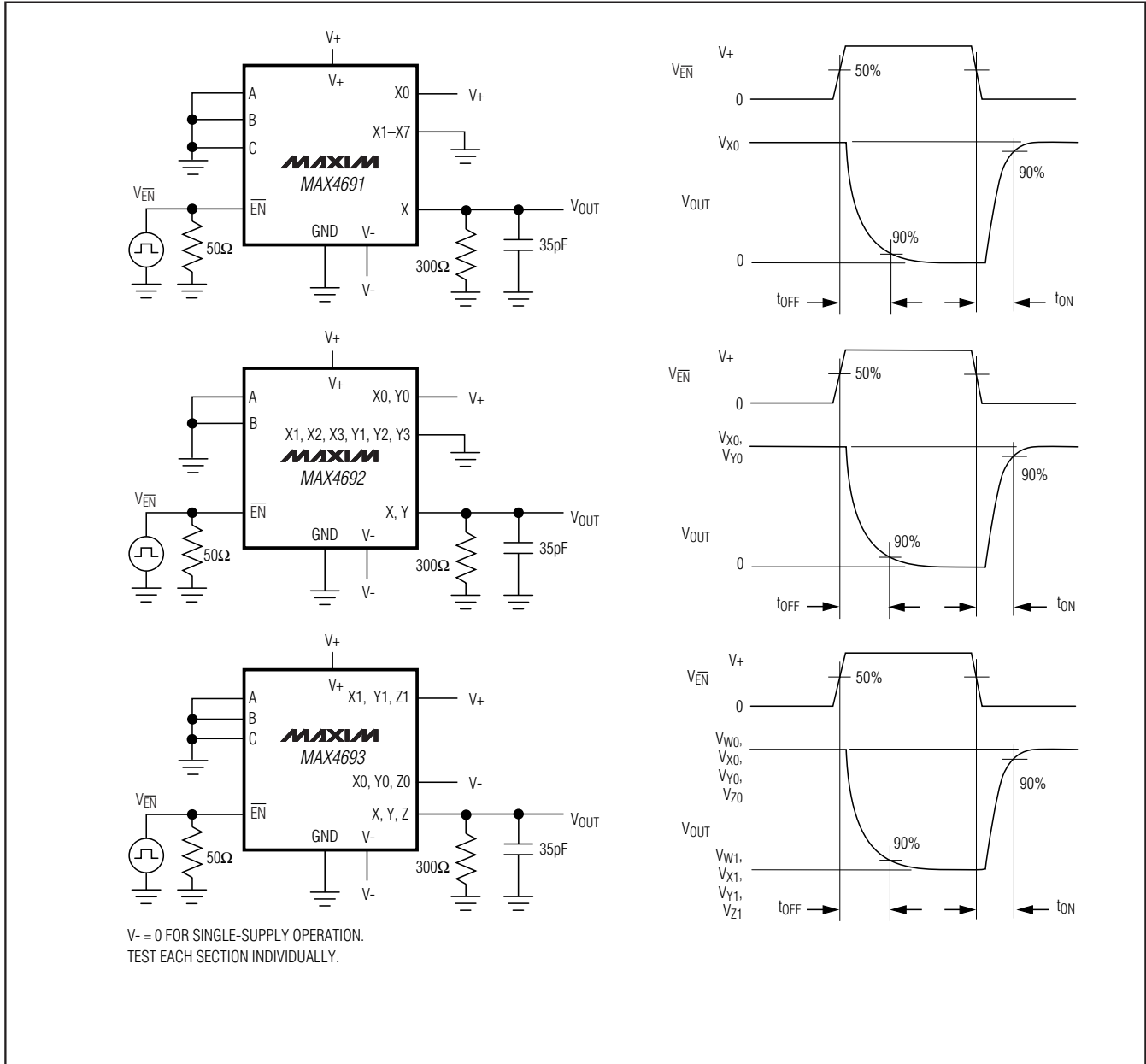

Figure 2. Enable Transition Time

Low-Voltage 8:1 Mux/Dual 4:1 Mux/Triple SPDT/ Quad SPDT in UCSP Package

Test Circuits/Timing Diagrams (continued)

MAX4691-MAX4694

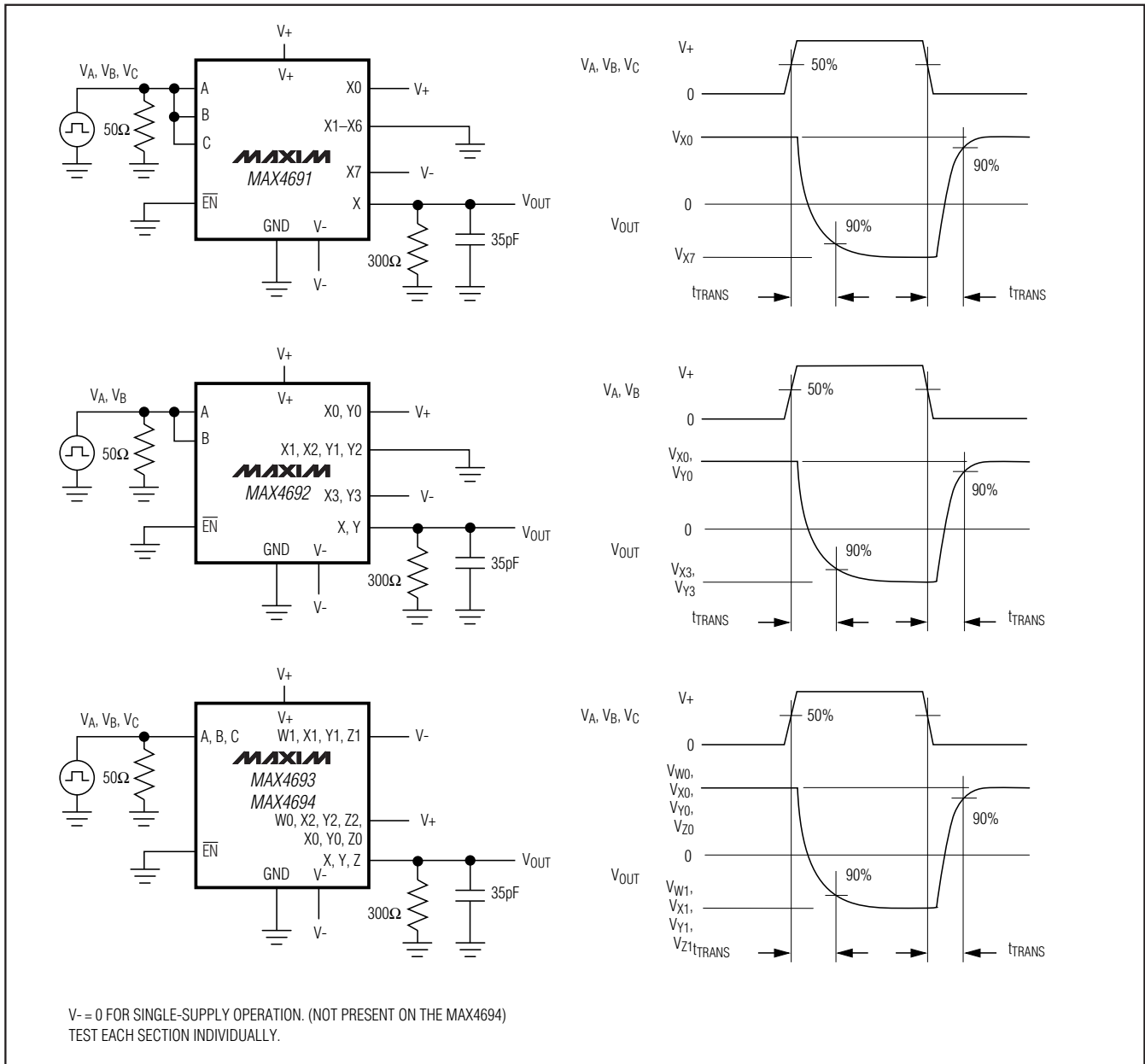

Figure 3. Address Transition Time

Low-Voltage 8:1 Mux/Dual 4:1 Mux/Triple SPDT/Quad SPDT in UCSP Package

Test Circuits/Timing Diagrams (continued)

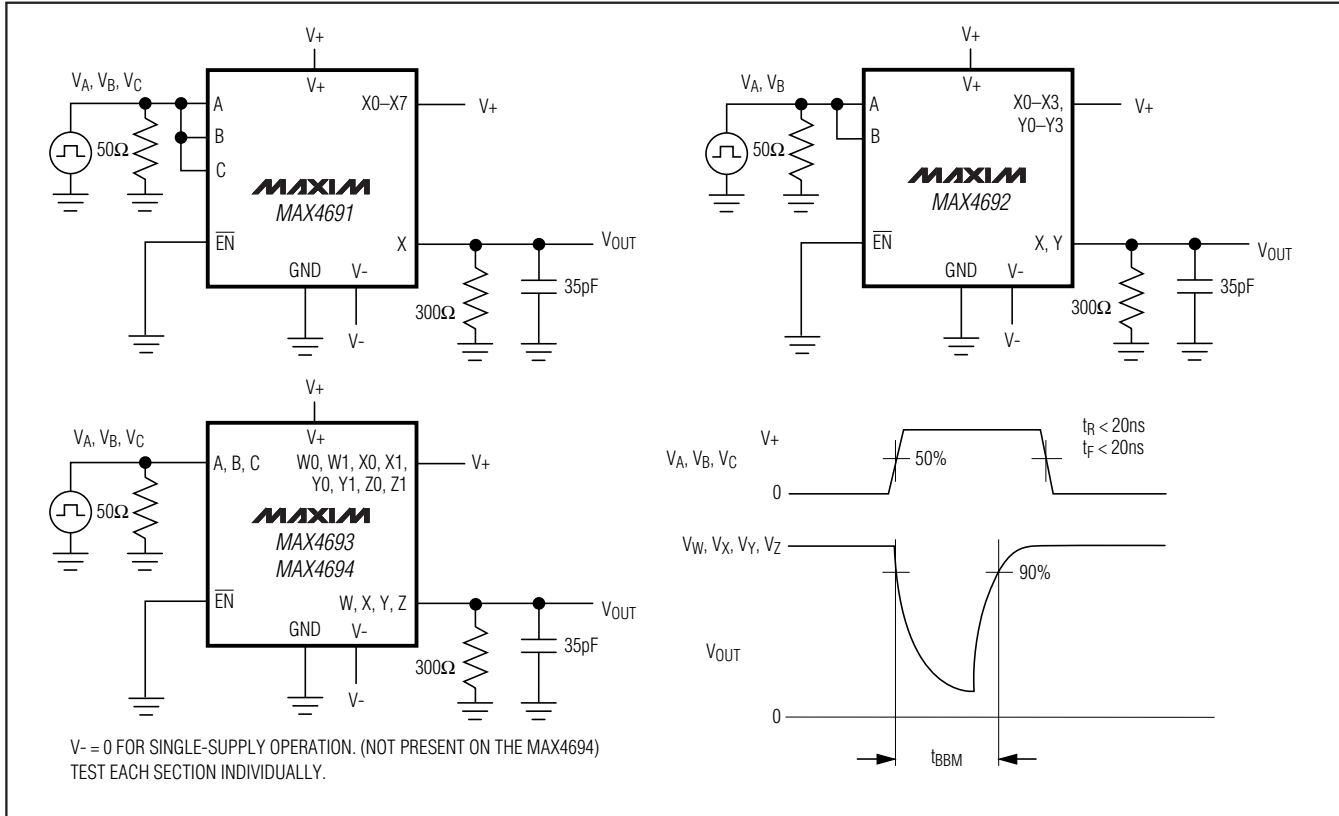

Figure 4. Break-Before-Make Interval

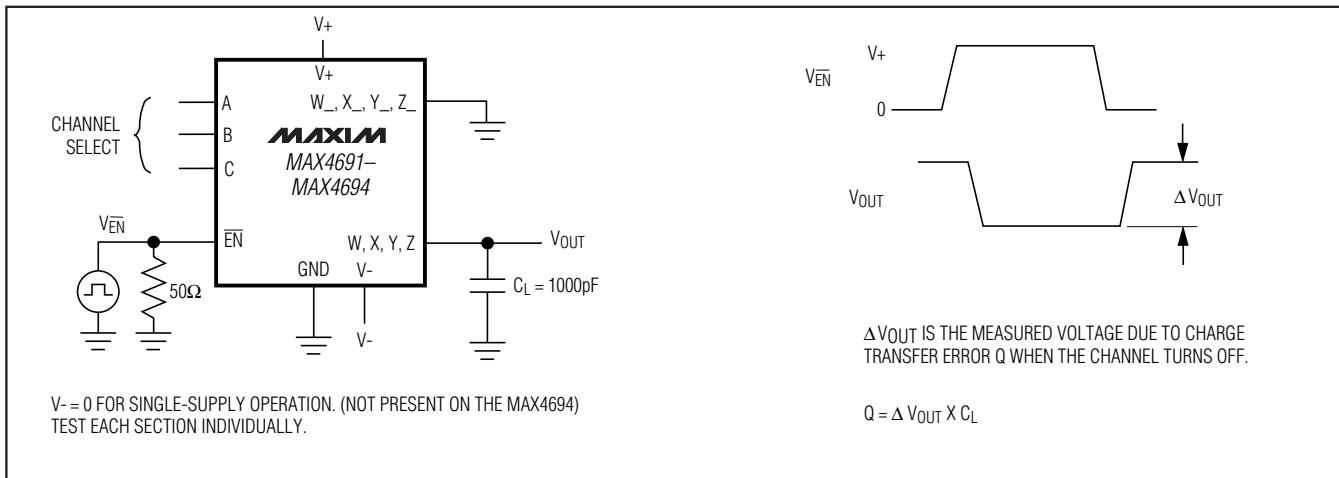

Figure 5. Charge Injection

Low-Voltage 8:1 Mux/Dual 4:1 Mux/Triple SPDT/Quad SPDT in UCSP Package

Test Circuits/Timing Diagrams (continued)

MAX4691-MAX4694

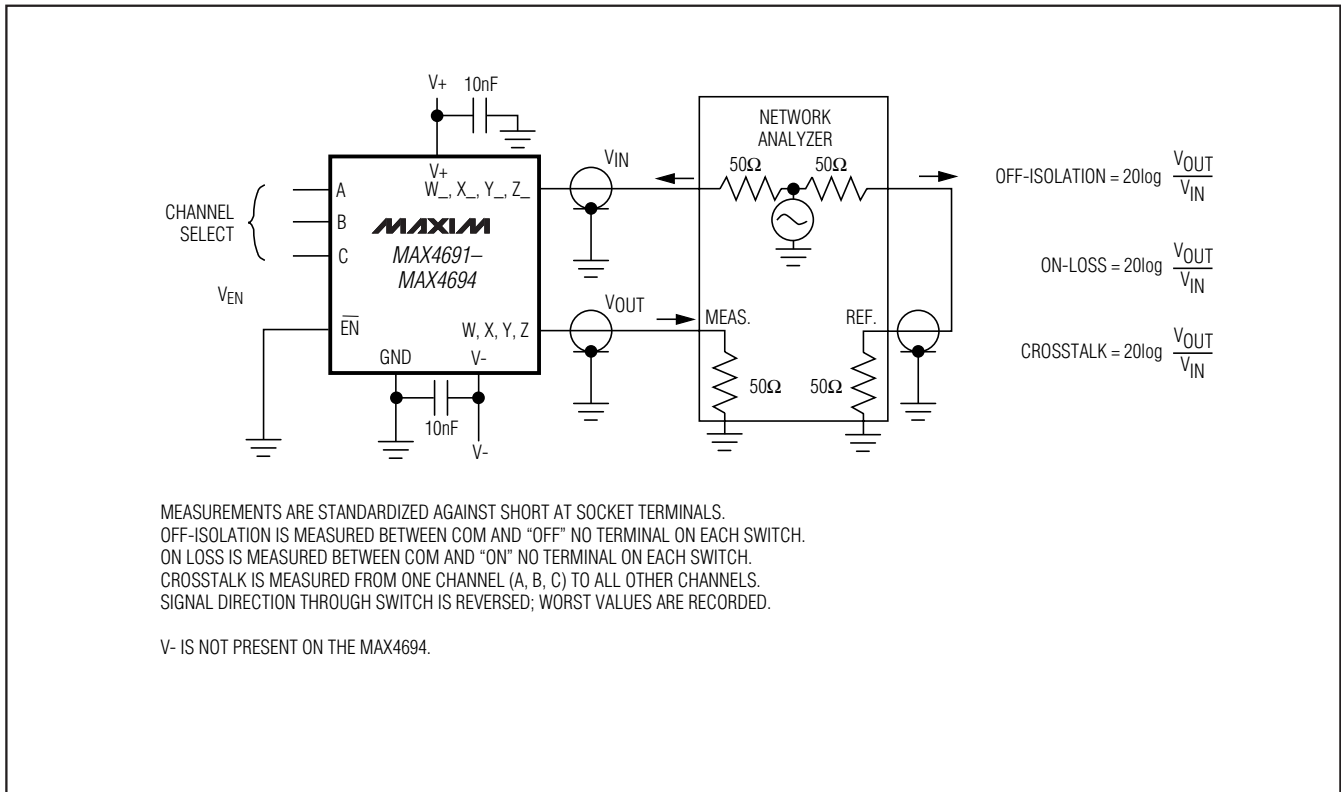

Figure 6. Off-Isolation, On-Loss, and Crosstalk

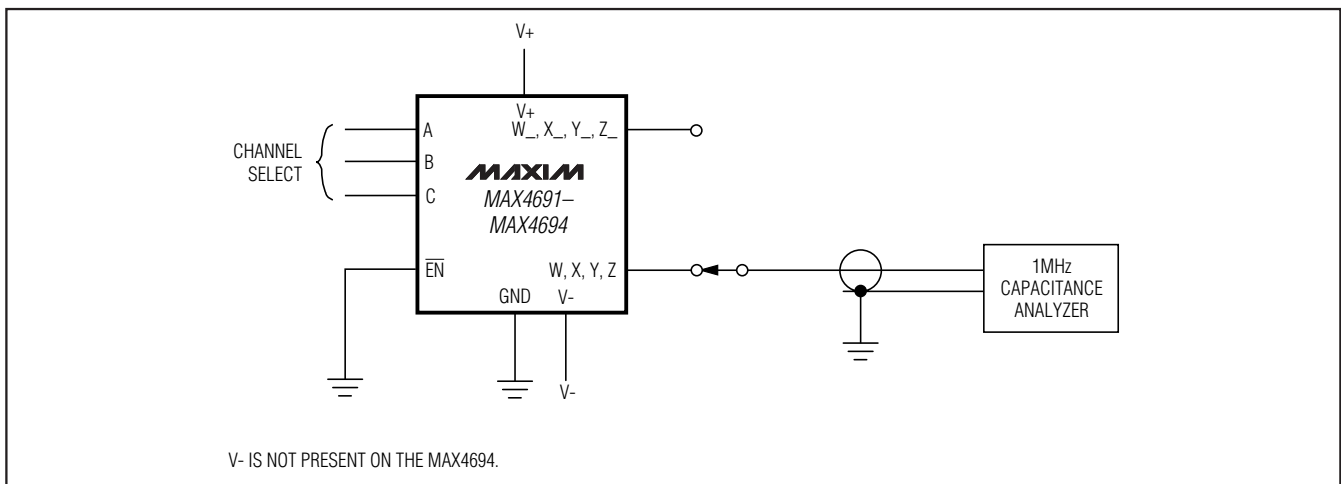
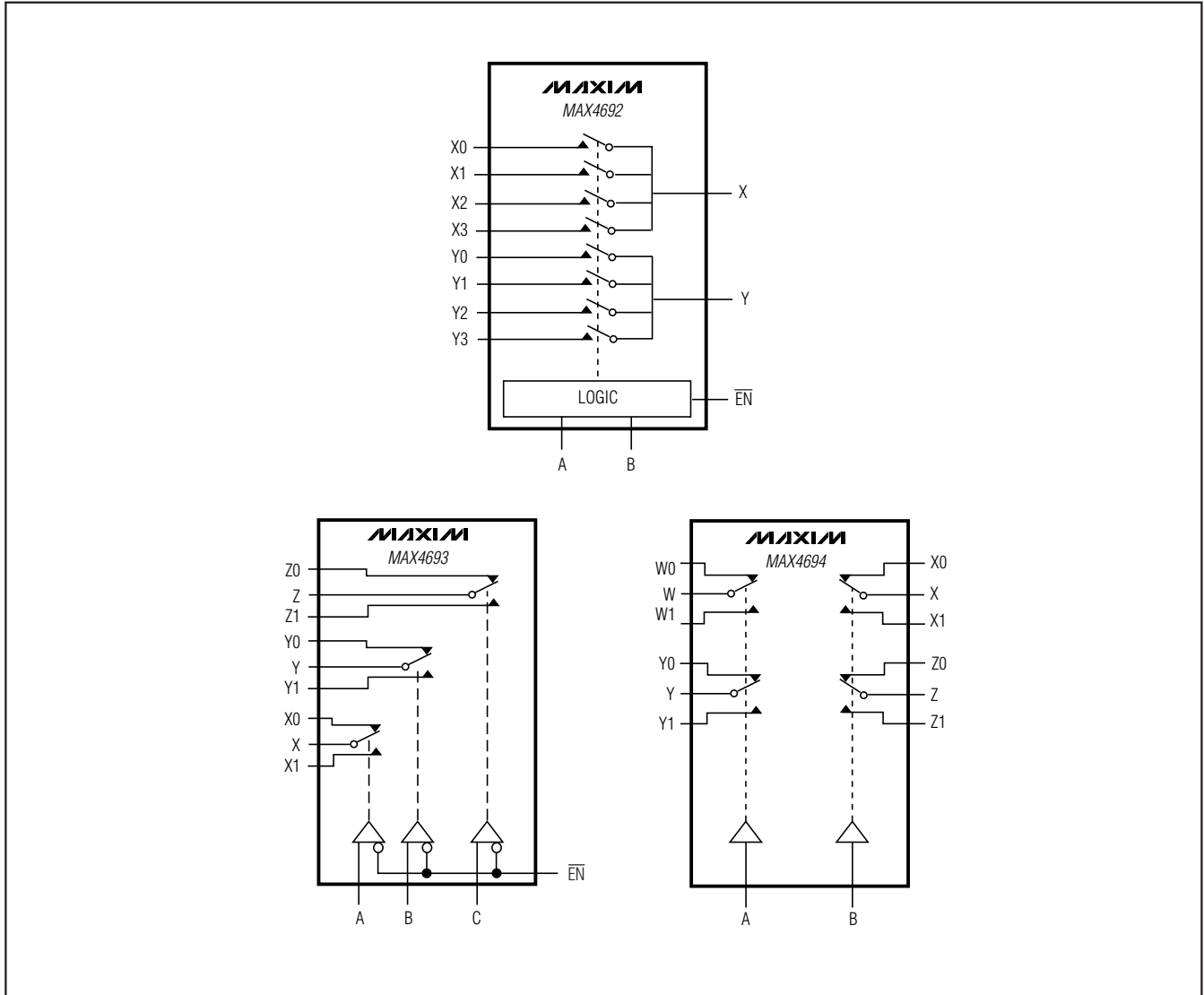

Figure 7. Capacitance

Low-Voltage 8:1 Mux/Dual 4:1 Mux/Triple SPDT/Quad SPDT in UCSP Package

Functional Diagrams (continued)



Chip Information

PROCESS: BiCMOS

Low-Voltage 8:1 Mux/Dual 4:1 Mux/Triple SPDT/ Quad SPDT in UCSP Package

Pin Configurations

MAX4691-MAX4694

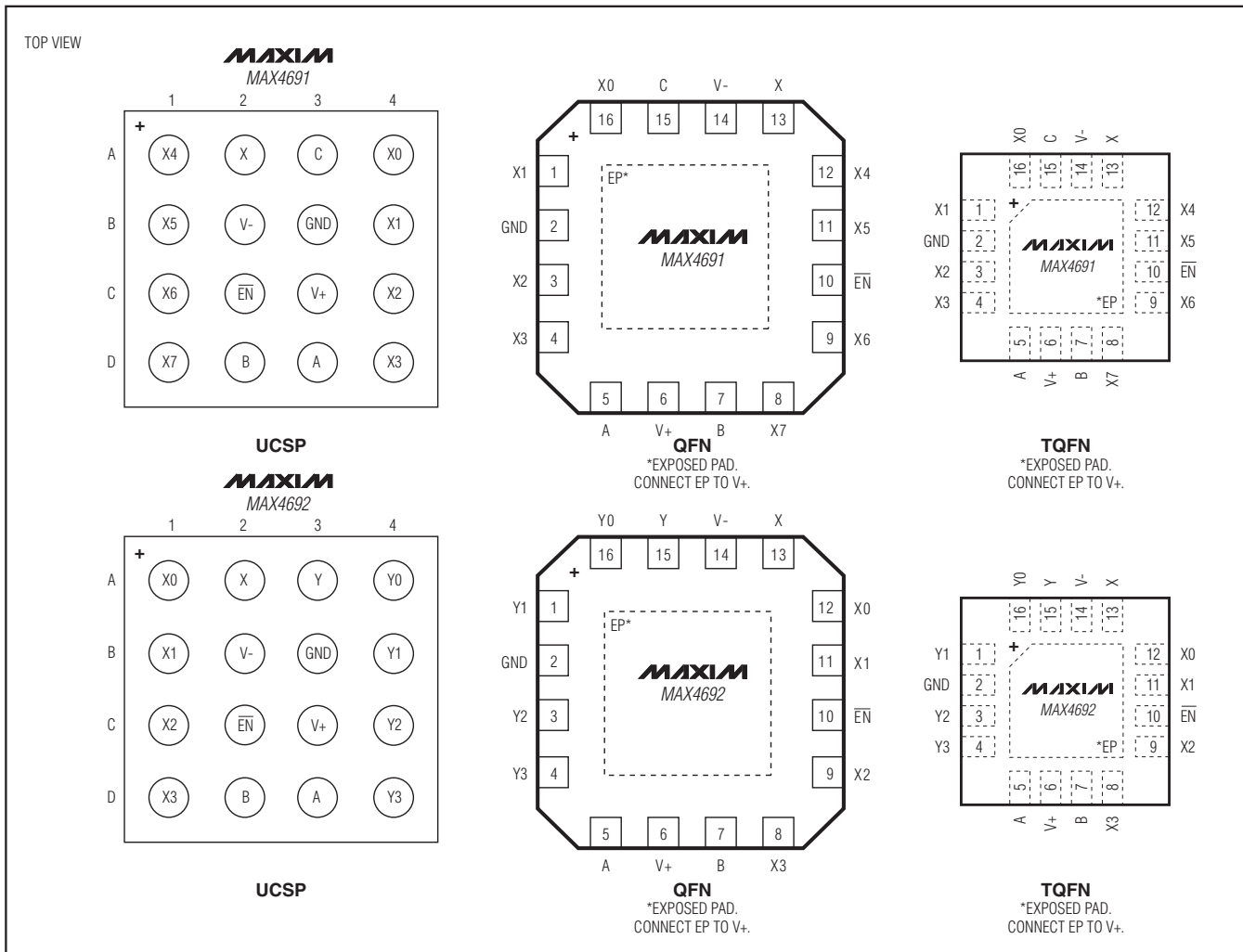

Low-Voltage 8:1 Mux/Dual 4:1 Mux/Triple SPDT/Quad SPDT in UCSP Package

Pin Configurations (continued)

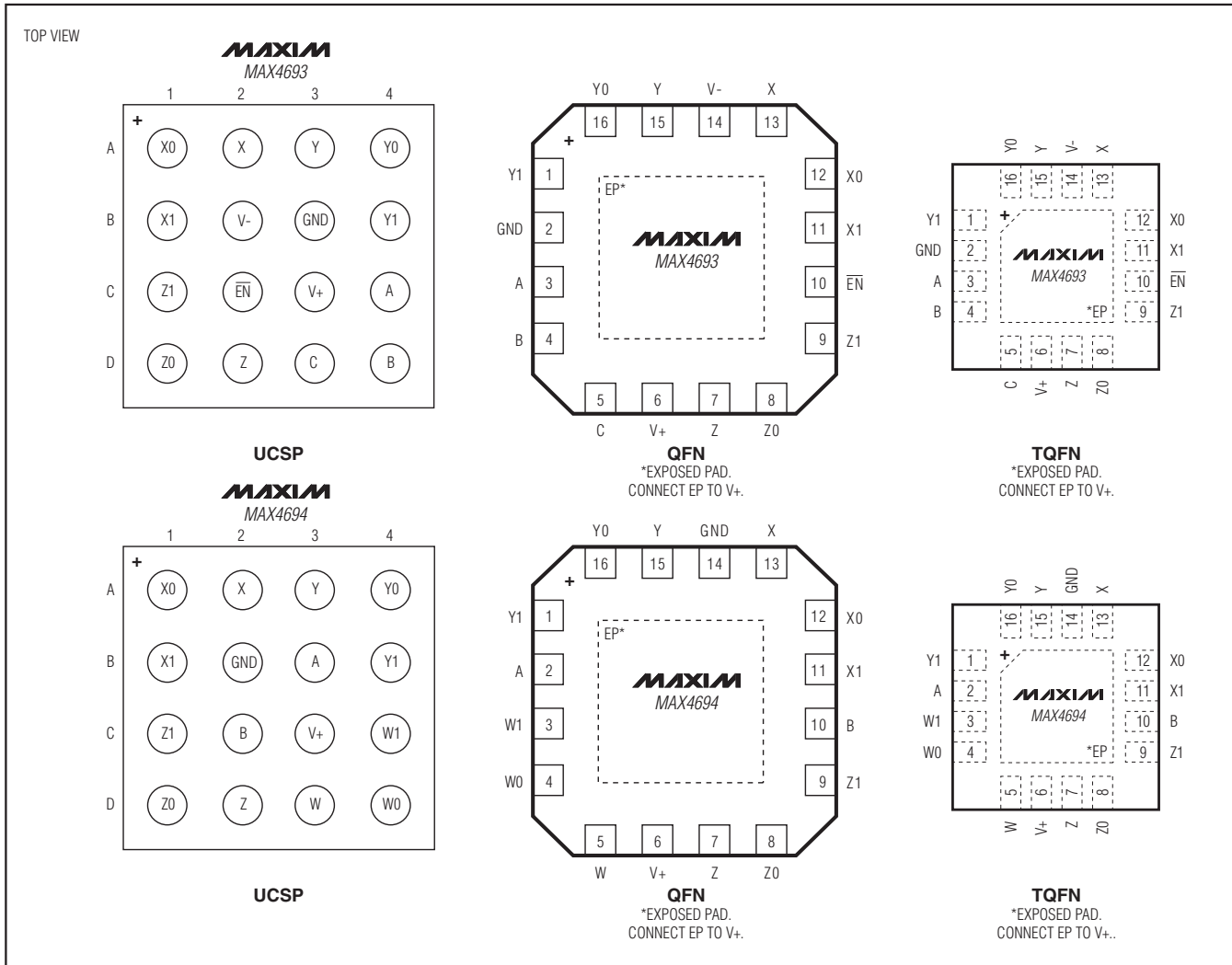

Package Information

For the latest package outline information and land patterns (footprints), go to www.maxim-ic.com/packages. Note that a "+", "#", or "-" in the package code indicates RoHS status only. Package drawings may show a different suffix character, but the drawing pertains to the package regardless of RoHS status.

| PACKAGE TYPE | PACKAGE CODE | OUTLINE NO. | LAND PATTERN NO. |
|--------------|--------------|-------------------------|--|
| 16 UCSP | B16+1 | 21-0101 | Refer to Application Note 1891 |
| 16 QFN-EP | G1644+1 | 21-0106 | 90-0216 |
| 16 TQFN-EP | T1644+4 | 21-0139 | 90-0070 |

Low-Voltage 8:1 Mux/Dual 4:1 Mux/Triple SPDT/ Quad SPDT in UCSP Package

Revision History

| REVISION NUMBER | REVISION DATE | DESCRIPTION | PAGES CHANGED |
|-----------------|---------------|---|--------------------------|
| 0 | 1/01 | Initial release | — |
| 1 | 7/01 | Added UCSP Package | — |
| 2 | 2/03 | Removed statement in <i>Features</i> section with UCSP now qualified | — |
| 3 | 12/06 | Exposed Paddle Connection information edited, style changes | 1, 9, 10, 11, 19, 21, 22 |
| 4 | 8/08 | Added part numbers, package diagram, and TQFN packaging | 1–26 |
| 5 | 3/09 | Added lead-free packaging, edited <i>Pin Description</i> , revised <i>Chip Information</i> , changed “floating” to “unconnected,” style changes | 1–6, 9, 10, 11, 18–21 |
| 6 | 1/12 | Updated <i>Absolute Maximum Ratings</i> and <i>Pin Description</i> sections | 2, 9, 10 |

MAX4691-MAX4694

Maxim cannot assume responsibility for use of any circuitry other than circuitry entirely embodied in a Maxim product. No circuit patent licenses are implied. Maxim reserves the right to change the circuitry and specifications without notice at any time. The parametric values (min and max limits) shown in the Electrical Characteristics table are guaranteed. Other parametric values quoted in this data sheet are provided for guidance.

21 **Maxim Integrated Products, 120 San Gabriel Drive, Sunnyvale, CA 94086 408-737-7600**

Mouser Electronics

Authorized Distributor

Click to View Pricing, Inventory, Delivery & Lifecycle Information:

[Analog Devices Inc.:](#)

[MAX4691EGE+](#) [MAX4691EGE+T](#) [MAX4691ETE+](#) [MAX4691ETE+T](#)