

General Description

The MAX17502 high-efficiency, high-voltage, synchronous step-down DC-DC converter with integrated MOSFETs operates over a 4.5V to 60V input voltage range. This device is offered in a fixed 3.3V, 5V or adjustable output voltage (0.9V to 92% V_{IN}) while delivering up to 1A of current. The output voltage is accurate to within $\pm 1.7\%$ over -40°C to $+125^{\circ}\text{C}$. The MAX17502 is available in compact TDFN and TSSOP packages. Simulation models are available.

The device features peak-current-mode control with pulse-width modulation (PWM) and operates with fixed switching frequency at any load. The low-resistance, on-chip MOSFETs ensure high efficiency at full load and simplify the layout.

A programmable soft-start feature allows users to reduce input inrush current. The device also incorporates an output enable/undervoltage lockout pin (EN/UVLO) that allows the user to turn on the part at the desired input-voltage level. An open-drain $\overline{\text{RESET}}$ pin provides a delayed power-good signal to the system upon achieving successful regulation of the output voltage.

Applications

- Industrial Process Control
- HVAC and Building Control
- Base Station, VOIP, Telecom
- Home Theatre
- Battery-Powered Equipment
- General-Purpose Point-of-Load

Benefits and Features

- Eliminates External Components and Reduces Total Cost
 - No Schottky-Synchronous Operation for High Efficiency and Reduced Cost
 - Internal Compensation and Feedback Divider for 3.3V and 5V Fixed Outputs
 - All-Ceramic Capacitors, Ultra-Compact Layout
- Reduces Number of DC-DC Regulators to Stock
 - Wide 4.5V to 60V Input Voltage Range
 - 0.9V to 92% V_{IN} Adjustable Output Voltage
 - Delivers up to 1A
 - 600kHz and 300kHz Switching Frequency Options
 - Available in a 10-Pin, 3mm x 2mm TDFN and 14-Pin, 5mm x 4.4mm TSSOP Packages
- Reduces Power Dissipation
 - Peak Efficiency > 90%
 - Shutdown Current = 0.9 μA (typ)
- Operates Reliably in Adverse Industrial Environments
 - Hiccup-Mode Current Limit, Sink Current Limit, and Autoretry Startup
 - Built-In Output-Voltage Monitoring (Open-Drain $\overline{\text{RESET}}$ Pin)
 - Resistor-Programmable EN/UVLO Threshold
 - Adjustable Soft-Start and Prebiased Power-Up
 - High Industrial -40°C to $+125^{\circ}\text{C}$ Ambient Operating Temperature Range/ -40°C to $+150^{\circ}\text{C}$ Junction Temperature Range

[Ordering Information/Selector Guide](#) appears at end of data sheet.

Absolute Maximum Ratings

| | | | |
|----------------------------------|------------------------------|--|-----------------|
| V_{IN} to GND..... | -0.3V to +70V | Output Short-Circuit Duration..... | Continuous |
| EN/UVLO to GND..... | -0.3V to ($V_{IN} + 0.3V$) | Junction Temperature..... | +150°C |
| LX to PGND..... | -0.3V to ($V_{IN} + 0.3V$) | Storage Temperature Range..... | -65°C to +160°C |
| FB, RESET, COMP, SS to GND | -0.3V to +6V | Lead Temperature (soldering, 10s)..... | +300°C |
| V_{CC} to GND..... | -0.3V to +6V | Soldering Temperature (reflow)..... | +260°C |
| GND to PGND..... | -0.3V to +0.3V | | |
| LX Total RMS Current..... | $\pm 1.6A$ | | |

Stresses beyond those listed under "Absolute Maximum Ratings" may cause permanent damage to the device. These are stress ratings only, and functional operation of the device at these or any other conditions beyond those indicated in the operational sections of the specifications is not implied. Exposure to absolute maximum rating conditions for extended periods may affect device reliability. Junction temperature greater than +125°C degrades operating lifetimes.

Package Thermal Characteristics (Note 1)

| | |
|--|--|
| 10 TDFN | 14 TSSOP |
| Continuous Power Dissipation ($T_A = +70^\circ C$) (derate 14.9mW/°C above +70°C) (multilayer board).1188.7mW | Continuous Power Dissipation ($T_A = +70^\circ C$) (derate 25.6mw/°C above +70°C)2051.3mW |
| Junction-to-Ambient Thermal Resistance (θ_{JA})67.3°C/W | Junction-to-Ambient Thermal Resistance (θ_{JA})39°C/W |
| Junction-to-Case Thermal Resistance (θ_{JC}).....18.2°C/W | Junction-to-Case Thermal Resistance (θ_{JC}).....3°C/W |

Note 1: Package thermal resistances were obtained using the method described in JEDEC specification JESD51-7, using a four-layer board. For detailed information on package thermal considerations, refer to www.maximintegrated.com/thermal-tutorial.

Electrical Characteristics

($V_{IN} = 24V$, $V_{GND} = V_{PGND} = 0V$, $C_{VIN} = 2.2\mu F$, $C_{VCC} = 1\mu F$, $V_{EN} = 1.5V$, $C_{SS} = 3300pF$, $V_{FB} = 0.98 \times V_{OUT}$, LX = unconnected, RESET = unconnected. $T_A = -40^\circ C$ to $+125^\circ C$, unless otherwise noted. Typical values are at $T_A = +25^\circ C$. All voltages are referenced to GND, unless otherwise noted.) (Note 2)

| PARAMETER | SYMBOL | CONDITIONS | MIN | TYP | MAX | UNITS |
|---|-----------------|--|---------------|-------|-------|---------|
| INPUT SUPPLY (V_{IN}) | | | | | | |
| Input Voltage Range | V_{IN} | | 4.5 | | 60 | V |
| Input Supply Current | I_{IN-SH} | $V_{EN} = 0V$, shutdown mode | | 0.9 | 3.5 | μA |
| | I_{IN-SW} | Normal switching mode, no load | MAX17502E/F/G | 4.75 | 6.75 | mA |
| MAX17502H | | | 2.5 | 3.6 | | |
| ENABLE/UVLO (EN/UVLO) | | | | | | |
| EN Threshold | V_{ENR} | V_{EN} rising | 1.194 | 1.218 | 1.236 | V |
| | V_{ENF} | V_{EN} falling | 1.114 | 1.135 | 1.156 | |
| | $V_{EN-TRUESD}$ | V_{EN} falling, true shutdown | | 0.7 | | |
| EN Input Leakage Current | I_{EN} | $V_{EN} = V_{IN} = 60V$, $T_A = +25^\circ C$ | | 8 | 200 | nA |
| LDO | | | | | | |
| V_{CC} Output Voltage Range | V_{CC} | $6V < V_{IN} < 12V$, $0mA < I_{VCC} < 10mA$, $12V < V_{IN} < 60V$, $0mA < I_{VCC} < 2mA$ | 4.65 | 5 | 5.35 | V |
| V_{CC} Current Limit | $I_{VCC-MAX}$ | $V_{CC} = 4.3V$, $V_{IN} = 12V$ | 15 | 40 | 80 | mA |
| V_{CC} Dropout | V_{CC-DO} | $V_{IN} = 4.5V$, $I_{VCC} = 5mA$ | 4.1 | | | V |
| V_{CC} UVLO | V_{CC-UVR} | V_{CC} rising | 3.85 | 4 | 4.15 | V |
| | V_{CC-UVF} | V_{CC} falling | 3.55 | 3.7 | 3.85 | |

Electrical Characteristics (continued)

($V_{IN} = 24V$, $V_{GND} = V_{PGND} = 0V$, $C_{VIN} = 2.2\mu F$, $C_{VCC} = 1\mu F$, $V_{EN} = 1.5V$, $C_{SS} = 3300pF$, $V_{FB} = 0.98 \times V_{OUT}$, LX = unconnected, RESET = unconnected. $T_A = -40^\circ C$ to $+125^\circ C$, unless otherwise noted. Typical values are at $T_A = +25^\circ C$. All voltages are referenced to GND, unless otherwise noted.) (Note 2)

| PARAMETER | SYMBOL | CONDITIONS | MIN | TYP | MAX | UNITS | |
|--|------------------|--|--|------|-----------------------|----------|---------|
| POWER MOSFETs | | | | | | | |
| High-Side pMOS On-Resistance | R_{DS-ONH} | $I_{LX} = 0.5A$ (sourcing) | $T_A = +25^\circ C$ | 0.55 | 0.85 | Ω | |
| | | | $T_A = T_J = +125^\circ C$ (Note 3) | | 1.2 | | |
| Low-Side nMOS On-Resistance | R_{DS-ONL} | $I_{LX} = 0.5A$ (sinking) | $T_A = +25^\circ C$ | 0.2 | 0.35 | Ω | |
| | | | $T_A = T_J = +125^\circ C$ (Note 3) | | 0.47 | | |
| LX Leakage Current | I_{LX_LKG} | $V_{EN} = 0V$, $T_A = +25^\circ C$, $V_{LX} = (V_{PGND} + 1V)$ to $(V_{IN} - 1V)$ | | | 1 | μA | |
| SOFT-START (SS) | | | | | | | |
| Charging Current | I_{SS} | $V_{SS} = 0.5V$ | 4.7 | 5 | 5.3 | μA | |
| FEEDBACK (FB/VO) | | | | | | | |
| FB Regulation Voltage | V_{FB_REG} | MAX17501G/H | 0.884 | 0.9 | 0.916 | V | |
| FB Input Bias Current | I_{FB} | $T_A = +25^\circ C$ | MAX17502E, $V_{FB} = 3.3V$ | 6.8 | 12 | 17 | μA |
| | | | MAX17502F, $V_{FB} = 5V$ | 6.8 | 12 | 17 | |
| | | | MAX17502G/H, $V_{FB} = 0.9V$ | | | 100 | nA |
| OUTPUT VOLTAGE (V_{OUT}) | | | | | | | |
| Output Voltage Range | V_{OUT} | MAX17502E | 3.248 | 3.3 | 3.352 | V | |
| | | MAX17502F | 4.922 | 5 | 5.08 | | |
| | | MAX17502G | 0.9 | | $0.92 \times V_{IN}$ | | |
| | | MAX17502H | 0.9 | | $0.965 \times V_{IN}$ | | |
| TRANSCONDUCTANCE AMPLIFIER (COMP) | | | | | | | |
| Transconductance | G_M | $I_{COMP} = \pm 2.5\mu A$, MAX17502G/H | 510 | 590 | 650 | μS | |
| COMP Source Current | I_{COMP_SRC} | MAX17502G/H | 19 | 32 | 55 | μA | |
| COMP Sink Current | I_{COMP_SINK} | MAX17502G/H | 19 | 32 | 55 | μA | |
| Current-Sense Transresistance | R_{CS} | MAX17502G/H | 0.45 | 0.5 | 0.55 | V/A | |

Electrical Characteristics (continued)

($V_{IN} = 24V$, $V_{GND} = V_{PGND} = 0V$, $C_{VIN} = 2.2\mu F$, $C_{VCC} = 1\mu F$, $V_{EN} = 1.5V$, $C_{SS} = 3300pF$, $V_{FB} = 0.98 \times V_{OUT}$, LX = unconnected, RESET = unconnected. $T_A = -40^\circ C$ to $+125^\circ C$, unless otherwise noted. Typical values are at $T_A = +25^\circ C$. All voltages are referenced to GND, unless otherwise noted.) (Note 2)

| PARAMETER | SYMBOL | CONDITIONS | MIN | TYP | MAX | UNITS | |
|---|---------------------|---|---------------|--------|-------|------------|-----|
| CURRENT LIMIT | | | | | | | |
| Peak Current-Limit Threshold | $I_{PEAK-LIMIT}$ | | 1.4 | 1.65 | 1.9 | A | |
| Runaway Current-Limit Threshold | $I_{RUNAWAY-LIMIT}$ | | 1.45 | 1.7 | 2 | A | |
| Sink Current-Limit Threshold | $I_{SINK-LIMIT}$ | MAX17502E/F/G/H | 0.56 | 0.65 | 0.74 | A | |
| TIMINGS | | | | | | | |
| Switching Frequency | f_{SW} | $V_{FB} > V_{OUT-HICF}$ | MAX17502E/F/G | 560 | 600 | 640 | kHz |
| | | HICF | MAX17502H | 280 | 300 | 320 | |
| | | $V_{FB} < V_{OUT-HICF}$ | | 280 | 300 | 320 | |
| Events to Hiccup after Crossing Runaway Current Limit | | | | 1 | | Event | |
| V_{OUT} Undervoltage Trip Level to Cause Hiccup | $V_{OUT-HICF}$ | $V_{SS} > 0.95V$ (soft-start is done) | 69.14 | 71.14 | 73.14 | % | |
| HICCUP Timeout | | | | 32,768 | | Cycles | |
| Minimum On-Time | t_{ON_MIN} | | | 75 | 120 | ns | |
| Maximum Duty Cycle | D_{MAX} | $V_{FB} = 0.98 \times V_{FB-REG}$ | MAX17502E/F/G | 92 | 94 | 96 | % |
| | | | MAX17502H | 96.5 | 97.5 | 98.5 | |
| LX Dead Time | | | | 5 | | ns | |
| RESET | | | | | | | |
| RESET Output Level Low | | $I_{RESET} = 1mA$ | | | 0.02 | V | |
| RESET Output Leakage Current High | | $V_{FB} = 1.01 \times V_{FB-REG}$, $T_A = +25^\circ C$ | | | 0.45 | μA | |
| V_{OUT} Threshold for RESET Falling | $V_{OUT-OKF}$ | V_{FB} falling | 90.5 | 92.5 | 94.5 | % | |
| V_{OUT} Threshold for RESET Rising | $V_{OUT-OKR}$ | V_{FB} rising | 93.5 | 95.5 | 97.5 | % | |
| RESET Delay After FB Reaches 95% Regulation | | V_{FB} rising | | 1024 | | Cycles | |
| THERMAL SHUTDOWN | | | | | | | |
| Thermal-Shutdown Threshold | | Temperature rising | | 165 | | $^\circ C$ | |
| Thermal-Shutdown Hysteresis | | | | 10 | | $^\circ C$ | |

Note 2: All limits are 100% tested at $+25^\circ C$. Limits over the operating temperature range and relevant supply voltage range are guaranteed by design and characterization.

Note 3: Guaranteed by design, not production tested.

Typical Operating Characteristics

($V_{IN} = 24V$, $V_{GND} = V_{PGND} = 0V$, $C_{VIN} = 2.2\mu F$, $C_{VCC} = 1\mu F$, $V_{EN} = 1.5V$, $C_{SS} = 3300pF$, $V_{FB} = 0.98 \times V_{OUT}$, LX = unconnected, RESET = unconnected, $T_A = -40^\circ C$ to $+125^\circ C$, unless otherwise noted. Typical values are at $T_A = +25^\circ C$. All voltages are referenced to GND, unless otherwise noted.)

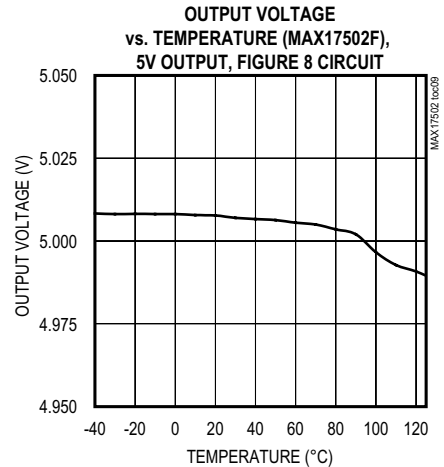
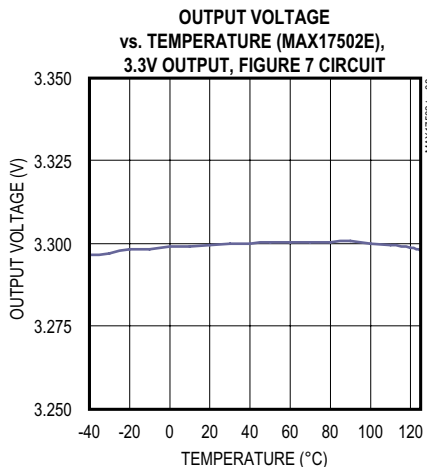
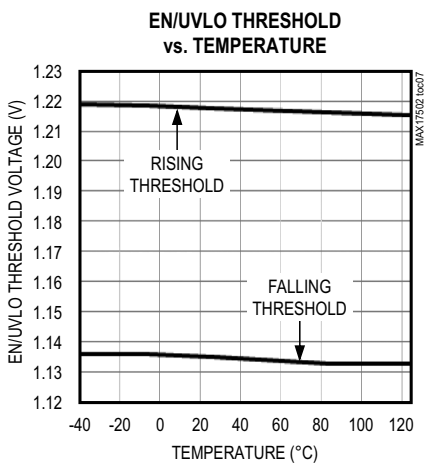
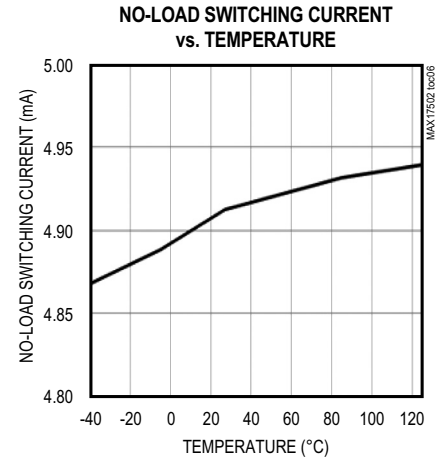
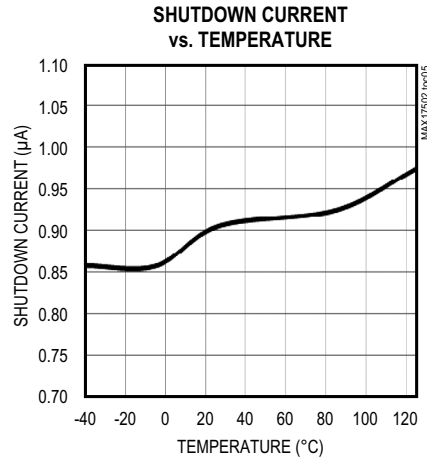
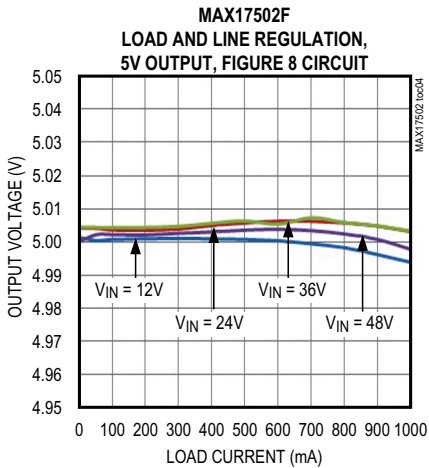
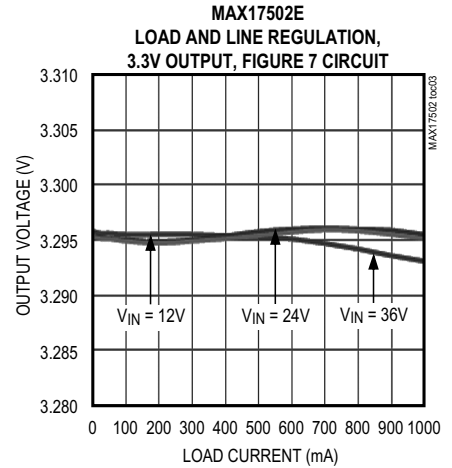
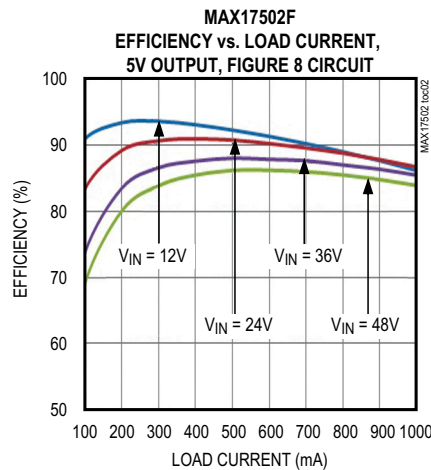
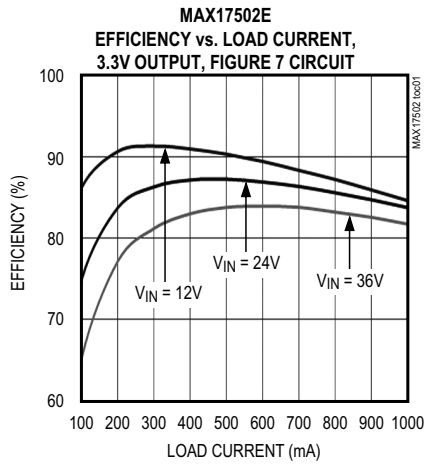

Typical Operating Characteristics (continued)

($V_{IN} = 24V$, $V_{GND} = V_{PGND} = 0V$, $C_{VIN} = 2.2\mu F$, $C_{VCC} = 1\mu F$, $V_{EN} = 1.5V$, $C_{SS} = 3300pF$, $V_{FB} = 0.98 \times V_{OUT}$, LX = unconnected, RESET = unconnected, $T_A = -40^\circ C$ to $+125^\circ C$, unless otherwise noted. Typical values are at $T_A = +25^\circ C$. All voltages are referenced to GND, unless otherwise noted.)

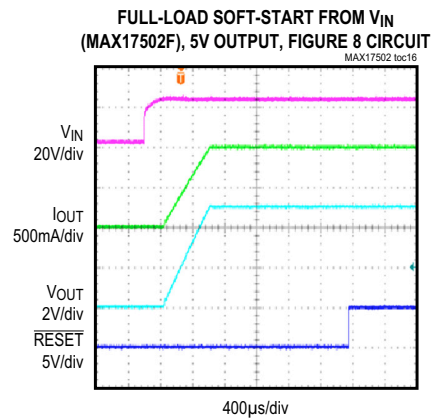
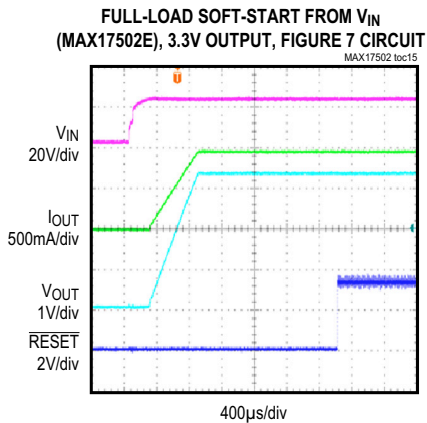
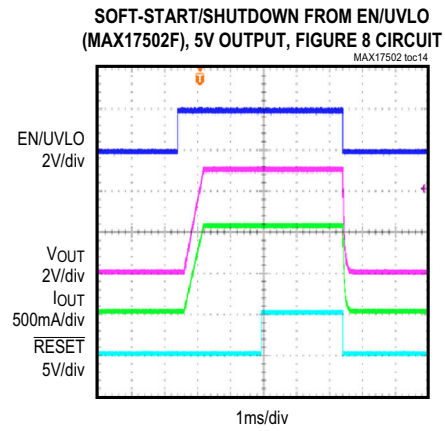
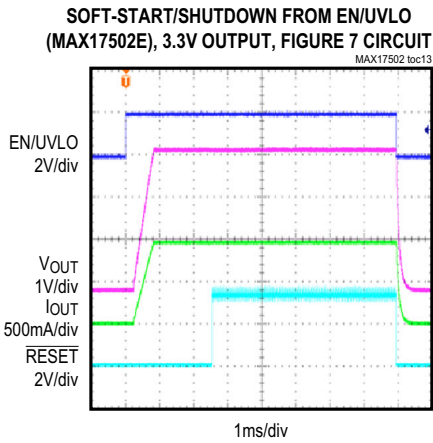
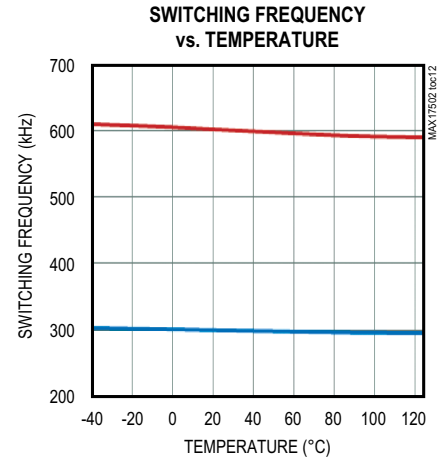
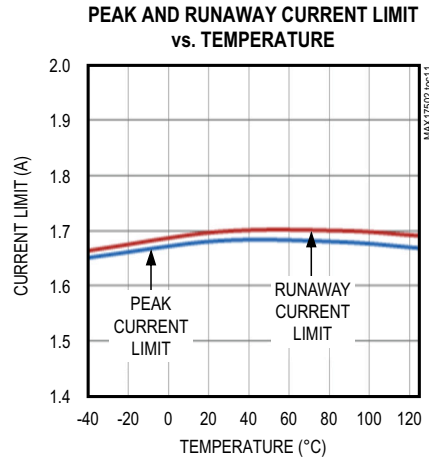
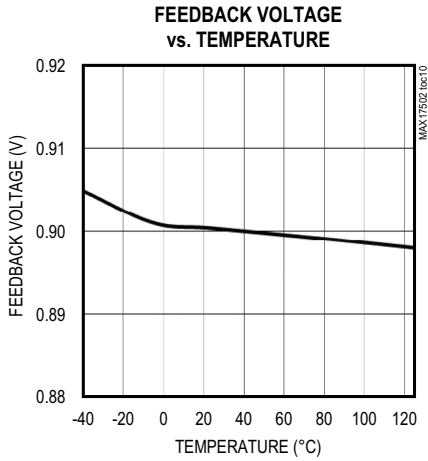

Typical Operating Characteristics (continued)

($V_{IN} = 24V$, $V_{GND} = V_{PGND} = 0V$, $C_{VIN} = 2.2\mu F$, $C_{VCC} = 1\mu F$, $V_{EN} = 1.5V$, $C_{SS} = 3300pF$, $V_{FB} = 0.98 \times V_{OUT}$, LX = unconnected, \overline{RESET} = unconnected, $T_A = -40^\circ C$ to $+125^\circ C$, unless otherwise noted. Typical values are at $T_A = +25^\circ C$. All voltages are referenced to GND, unless otherwise noted.)

SOFT-START WITH 2V PREBIAS
(MAX17502E), 3.3V OUTPUT, FIGURE 7 CIRCUIT

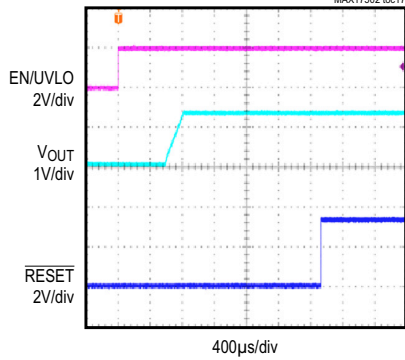

SOFT-START WITH 2.5V PREBIAS
(MAX17502F), 5V OUTPUT, FIGURE 8 CIRCUIT

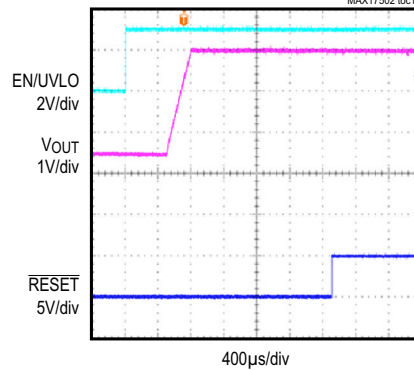

LOAD TRANSIENT RESPONSE OF MAX17502E
(LOAD CURRENT STEPPED FROM NO-LOAD TO 500mA),
3.3V OUTPUT, FIGURE 7 CIRCUIT

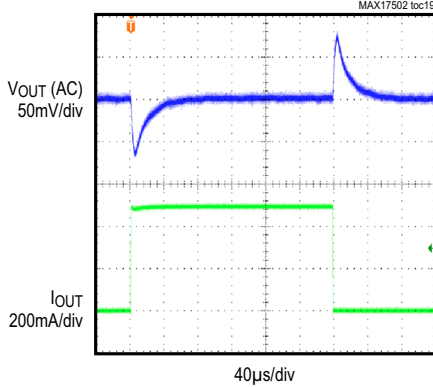

LOAD TRANSIENT RESPONSE OF MAX17502F
(LOAD CURRENT STEPPED FROM NO-LOAD TO 500mA),
5V OUTPUT, FIGURE 8 CIRCUIT

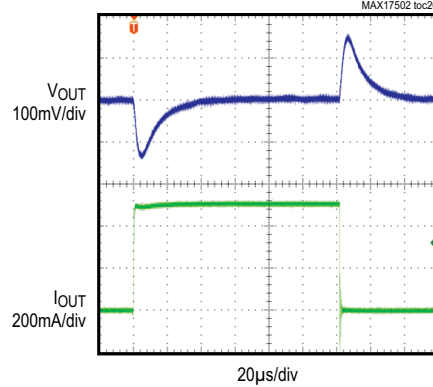

LOAD TRANSIENT RESPONSE OF MAX17502E
(LOAD CURRENT STEPPED FROM 500mA TO 1A),
3.3V OUTPUT, FIGURE 7 CIRCUIT

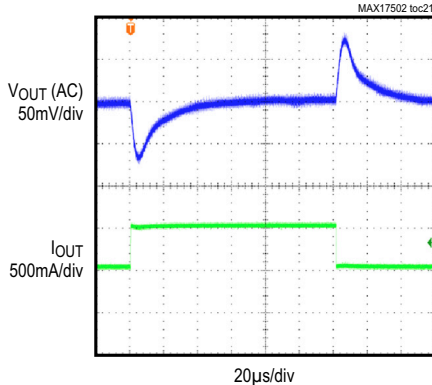

LOAD TRANSIENT RESPONSE OF MAX17502F
(LOAD CURRENT STEPPED FROM 500mA TO 1A),
5V OUTPUT, FIGURE 8 CIRCUIT

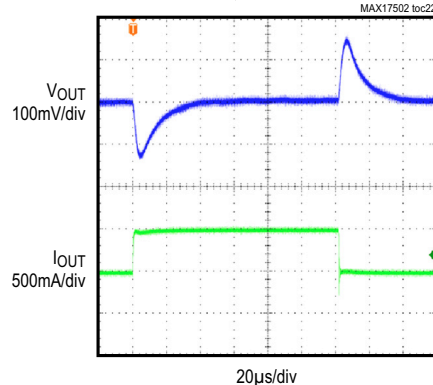

Typical Operating Characteristics (continued)

($V_{IN} = 24V$, $V_{GND} = V_{PGND} = 0V$, $C_{VIN} = 2.2\mu F$, $C_{VCC} = 1\mu F$, $V_{EN} = 1.5V$, $C_{SS} = 3300pF$, $V_{FB} = 0.98 \times V_{OUT}$, LX = unconnected, RESET = unconnected, $T_A = -40^\circ C$ to $+125^\circ C$, unless otherwise noted. Typical values are at $T_A = +25^\circ C$. All voltages are referenced to GND, unless otherwise noted.)

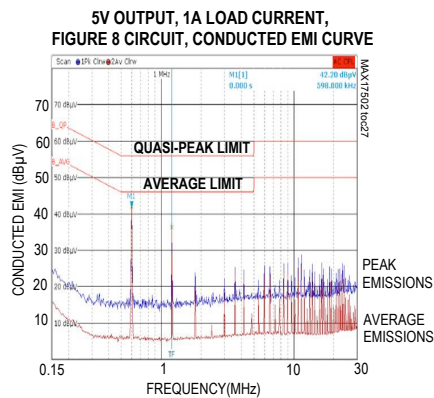
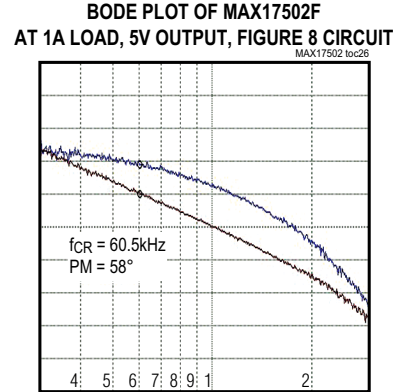
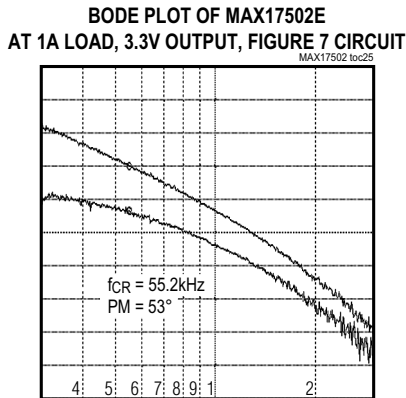
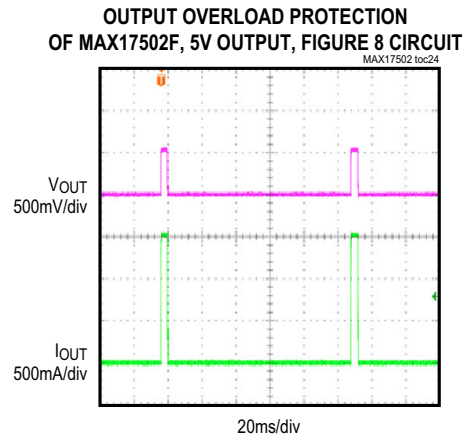
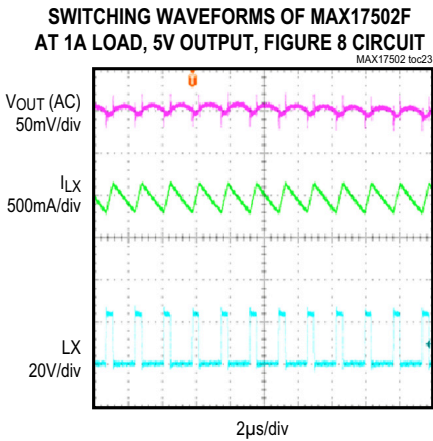

MEASURED ON THE MAX17502FTEVKIT WITH INPUT FILTER— $C_{IN} = 2.2\mu F$, $L_{IN} = 10\mu H$

Pin Configurations

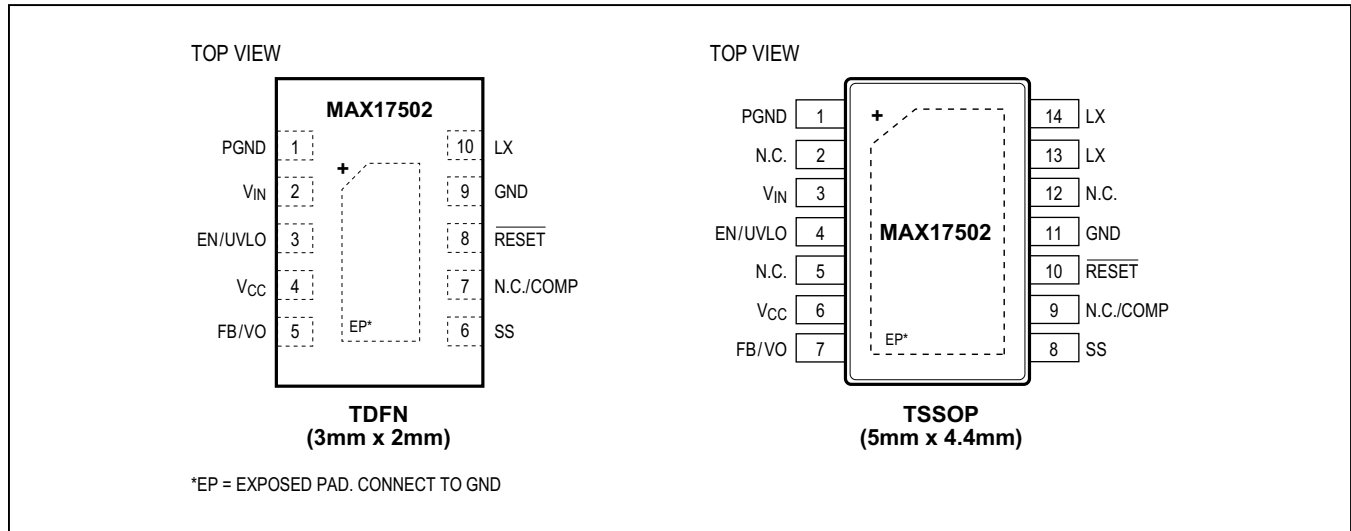

Pin Description

| PIN | | NAME | FUNCTION |
|------|----------|-----------------|---|
| TDFN | TSSOP | | |
| 1 | 1 | PGND | Power Ground. Connect PGND externally to the power ground plane. Connect GND and PGND pins together at the ground return path of the V _{CC} bypass capacitor. |
| 2 | 3 | V _{IN} | Power-Supply Input. The input supply range is from 4.5V to 60V. |
| 3 | 4 | EN/UVLO | Enable/Undervoltage Lockout Input. Drive EN/UVLO high to enable the output voltage. Connect to the center of the resistive divider between V _{IN} and GND to set the input voltage (undervoltage threshold) at which the device turns on. Pull up to V _{IN} for always on. |
| 4 | 6 | V _{CC} | 5V LDO Output. Bypass V _{CC} with 1μF ceramic capacitance to GND. |
| 5 | 7 | FB/VO | Feedback Input. For fixed output voltage devices, directly connect FB/VO to the output. For adjustable output voltage devices, connect FB/VO to the center of the resistive divider between V _{OUT} and GND. |
| 6 | 8 | SS | Soft-Start Input. Connect a capacitor from SS to GND to set the soft-start time. |
| 7 | 9 | N.C./COMP | External Loop Compensation. For adjustable output voltage (MAX17502G/H), connect to an RC network from COMP to GND. See External Loop Compensation for Adjustable Output Versions section for more details. For fixed output voltage (MAX17502E/F), this pin is a no connect (N.C.) and should be left unconnected. |
| 8 | 10 | RESET | Open-Drain RESET Output. The RESET output is driven low if FB drops below 92.5% of its set value. RESET goes high 1024 clock cycles after FB rises above 95.5% of its set value. RESET is valid when the device is enabled and V _{IN} is above 4.5V. |
| 9 | 11 | GND | Analog Ground |
| 10 | 13, 14 | LX | Switching Node. Connect LX to the switching side of the inductor. LX is high impedance when the device is in shutdown mode. |
| — | 2, 5, 12 | N.C. | No Connection. Not internally connected. |
| — | | EP | Exposed Pad. Connect to the GND pin of the IC. Connect to a large copper plane below the IC to improve heat dissipation capability. |

Block Diagram

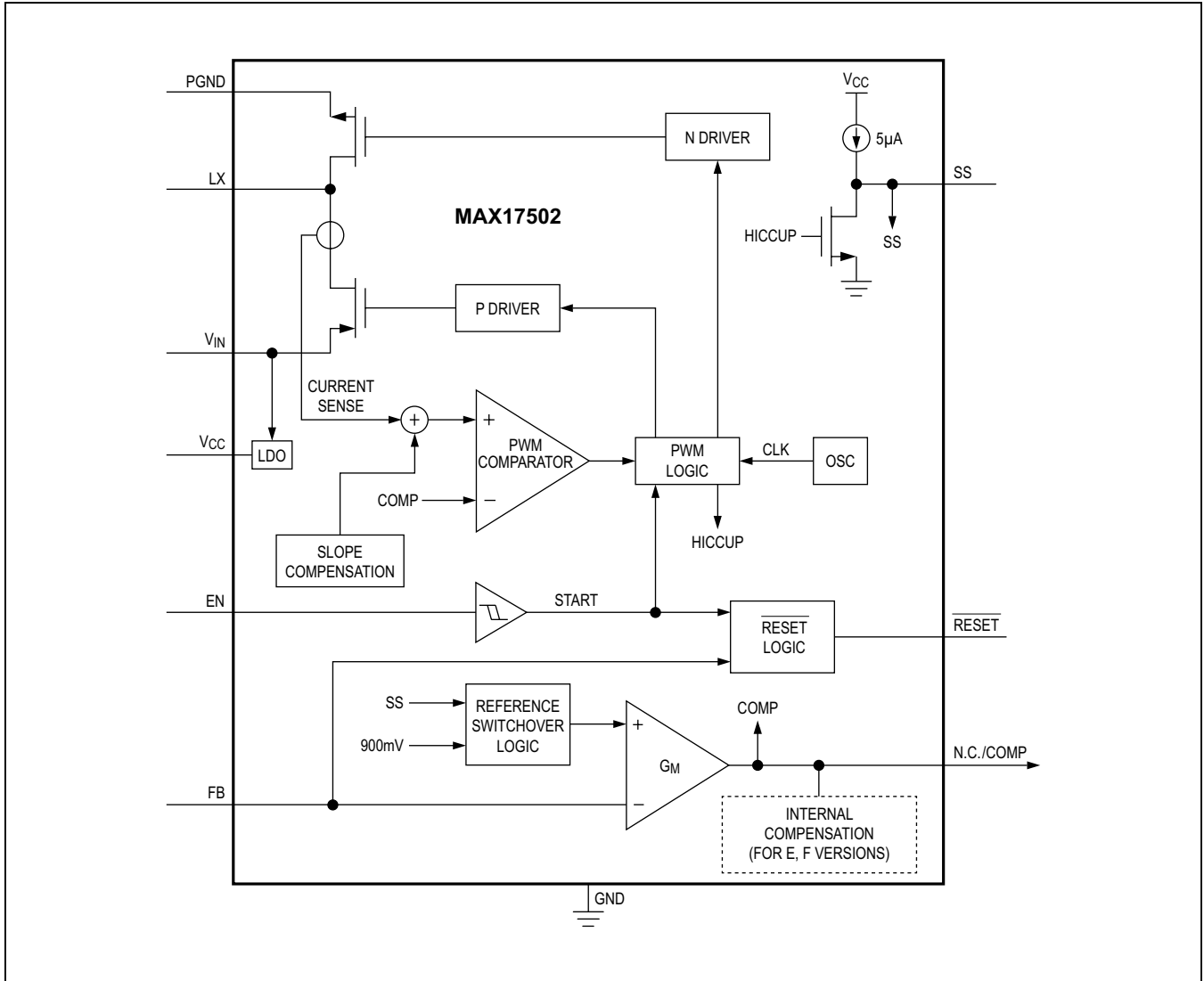

Detailed Description

The MAX17502 synchronous step-down regulator operates from 4.5V to 60V and delivers up to 1A load current. Output voltage regulation accuracy meets $\pm 1.7\%$ over temperature.

The device uses a peak-current-mode control scheme. An internal transconductance error amplifier generates an integrated error voltage. The error voltage sets the duty cycle using a PWM comparator, a high-side current-sense amplifier, and a slope-compensation generator. At each rising edge of the clock, the high-side p-channel MOSFET turns on and remains on until either the appropriate or maximum duty cycle is reached, or the peak current limit is detected.

During the high-side MOSFET's on-time, the inductor current ramps up. During the second half of the switching cycle, the high-side MOSFET turns off and the low-side n-channel MOSFET turns on and remains on until either the next rising edge of the clock arrives or sink current limit is detected. The inductor releases the stored energy as its current ramps down, and provides current to the output (the internal low $R_{\text{DS(on)}}$ pMOS/nMOS switches ensure high efficiency at full load).

This device also integrates enable/undervoltage lockout (EN/UVLO), adjustable soft-start time (SS), and open-drain reset output ($\overline{\text{RESET}}$) functionality.

Linear Regulator (V_{CC})

An internal linear regulator (V_{CC}) provides a 5V nominal supply to power the internal blocks and the low-side MOSFET driver. The output of the V_{CC} linear regulator should be bypassed with a 1 μ F ceramic capacitor to GND. The device employs an undervoltage-lockout circuit that disables the internal linear regulator when V_{CC} falls below 3.7V (typical). The internal V_{CC} linear regulator can source up to 40mA (typical) to supply the device and to power the low-side gate driver.

Operating Input Voltage Range

The maximum operating input voltage is determined by the minimum controllable on-time and the minimum operating input voltage is determined by the maximum duty cycle and circuit voltage drops. The minimum and maximum operating input voltages for a given output voltage should be calculated as:

$$V_{\text{IN(MIN)}} = \frac{V_{\text{OUT}} + (I_{\text{OUT(MAX)}} \times (R_{\text{DCR}} + 0.47))}{D_{\text{MAX}}} + (I_{\text{OUT(MAX)}} \times 0.73)$$

$$V_{\text{IN(MAX)}} = \frac{V_{\text{OUT}}}{f_{\text{SW(MAX)}} \times t_{\text{ON(MIN)}}}$$

where V_{OUT} is the steady-state output voltage, I_{OUT(MAX)} is the maximum load current, R_{DCR} is the DC resistance of the inductor, f_{SW(MAX)} is the switching frequency (maximum) and t_{ON(MIN)} is the worst-case minimum switch on-time (120ns). The following table lists the f_{SW(MAX)} and D_{MAX} values to be used for calculation for different versions of the MAX17502:

| PART VERSION | f _{SW(MAX)} (kHz) | D _{MAX} |
|---------------|----------------------------|------------------|
| MAX17502E/F/G | 640 | 0.92 |
| MAX17502H | 320 | 0.965 |

Overcurrent Protection/HICCUP Mode

The device is provided with a robust overcurrent-protection scheme that protects the device under overload and output short-circuit conditions. A cycle-by-cycle peak current limit turns off the high-side MOSFET whenever the high-side switch current exceeds an internal limit of 1.65A (typ). A runaway current limit on the high-side switch current at 1.7A (typ) protects the device under high input voltage, short-circuit conditions when there is insufficient output voltage available to restore the inductor current that built up during the on period of the step-down converter. One occurrence of the runaway current limit triggers a hiccup mode. In addition, if due to a fault condition, output voltage drops to 71.14% (typ) of its nominal value any time after soft-start is complete, hiccup mode is triggered.

In hiccup mode, the converter is protected by suspending switching for a hiccup timeout period of 32,768 clock cycles. Once the hiccup timeout period expires, soft-start is attempted again. This operation results in minimal power dissipation under overload fault conditions.

$\overline{\text{RESET}}$ Output

The device includes a $\overline{\text{RESET}}$ comparator to monitor the output voltage. The open-drain $\overline{\text{RESET}}$ output requires an external pullup resistor. $\overline{\text{RESET}}$ can sink 2mA of current while low. $\overline{\text{RESET}}$ goes high (high impedance) 1024 switching cycles after the regulator output increases above 95.5% of the designated nominal regulated voltage. $\overline{\text{RESET}}$ goes low when the regulator output voltage drops to below 92.5% of the nominal regulated voltage. $\overline{\text{RESET}}$ also goes low during thermal shutdown. $\overline{\text{RESET}}$ is valid when the device is enabled and V_{IN} is above 4.5V.

Prebiased Output

When the device starts into a prebiased output, both the high-side and low-side switches are turned off so the converter does not sink current from the output. High-side and low-side switches do not start switching until the PWM comparator commands the first PWM pulse, at which point switching commences first with the high-side switch. The output voltage is then smoothly ramped up to the target value in alignment with the internal reference.

Thermal-Overload Protection

Thermal-overload protection limits total power dissipation in the device. When the junction temperature of the device exceeds +165°C, an on-chip thermal sensor shuts down the device, allowing the device to cool. The thermal sensor turns the device on again after the junction temperature cools by 10°C. Soft-start resets during thermal shutdown. Carefully evaluate the total power dissipation (see the [Power Dissipation](#) section) to avoid unwanted triggering of the thermal-overload protection in normal operation.

Applications Information

Input Capacitor Selection

The discontinuous input-current waveform of the buck converter causes large ripple currents in the input capacitor. The switching frequency, peak inductor current, and the allowable peak-to-peak voltage ripple that reflects back to the source dictate the capacitance requirement. The device's high switching frequency allows the use of smaller value input capacitors. X7R capacitors are recommended in industrial applications for their temperature stability. A minimum value of 2.2µF should be used for the input capacitor. Higher values help reduce the ripple on the input DC bus further. In applications where the source is located distant from the device input, an electrolytic capacitor should be added in parallel to the 2.2µF ceramic capacitor to provide necessary damping for potential oscillations caused by the longer input power path and input ceramic capacitor.

Inductor Selection

Three key inductor parameters must be specified for operation with the device: inductance value (L), inductor saturation current (I_{SAT}), and DC resistance (R_{DCR}). The switching frequency, and output voltage determine the inductor value as follows:

$$L = \frac{2.4 \times V_{OUT}}{f_{SW}}$$

where V_{OUT} and f_{SW} are nominal values.

Select a low-loss inductor closest to the calculated value with acceptable dimensions and having the lowest possible DC resistance. The saturation current rating (I_{SAT}) of the inductor must be high enough to ensure that saturation can occur only above the peak current-limit value (I_{PEAK-LIMIT} (typ) = 1.65A for the device).

Output Capacitor Selection

X7R ceramic output capacitors are preferred due to their stability over temperature in industrial applications. The output capacitor is usually sized to support a step load of 50% of the maximum output current in the application, so the output-voltage deviation is contained to ±3% of the output-voltage change.

For fixed 3.3V output voltage versions, connect a minimum of 22µF (1210) capacitor at the output. For fixed 5V output voltage versions, connect a minimum of 10µF (1210) capacitor at the output. For adjustable output voltage versions, the output capacitance can be calculated as follows:

$$C_{OUT} = \frac{1}{2} \times \frac{I_{STEP} \times t_{RESPONSE}}{\Delta V_{OUT}}$$

$$t_{RESPONSE} \cong \frac{0.33}{f_C} + \frac{1}{f_{SW}}$$

where I_{STEP} is the load current step, t_{RESPONSE} is the response time of the controller, ΔV_{OUT} is the allowable output-voltage deviation, f_C is the target closed-loop cross-over frequency, and f_{SW} is the switching frequency. Select f_C to be 1/12th of f_{SW}. Consider DC bias and aging effects while selecting the output capacitor.

Soft-Start Capacitor Selection

The MAX17502 implements adjustable soft-start operation to reduce inrush current. A capacitor connected from the SS pin to GND programs the soft-start period.

The selected output capacitance (C_{SEL}) and the output voltage (V_{OUT}) determine the minimum required soft-start capacitor as follows:

$$C_{SS} \geq 19 \times 10^6 \times C_{SEL} \times V_{OUT}$$

The soft-start time (t_{SS}) is related to the capacitor connected at SS (C_{SS}) by the following equation:

$$t_{SS} = \frac{C_{SS}}{5.55 \times 10^6}$$

Adjusting Output Voltage

The MAX17502E and MAX17502F have preset output voltages of 3.3V and 5.0V, respectively. Connect FB/VO directly to the positive terminal of the output capacitor (see the [Typical Applications Circuits](#)).

The MAX17502G/H offer an adjustable output voltage from 0.9V to 92%V_{IN}. Set the output voltage with a resistive voltage-divider connected from the positive terminal of the output capacitor (V_{OUT}) to GND (see [Figure 1](#)). Connect the center node of the divider to FB/VO. To optimize efficiency and output accuracy, use the following procedure to choose the values of R4 and R5:

For MAX17502G, select the parallel combination of R4 and R5, R_p to be less than 15kΩ. For the MAX17502H, select the parallel combination of R4 and R5, R_p to be less than 30kΩ. Once R_p is selected, calculate R4 as:

$$R4 = \frac{Rp \times V_{OUT}}{0.9}$$

Calculate R5 as follows:

$$R5 = \frac{R4 \times 0.9}{(V_{OUT} - 0.9)}$$

Setting the Input Undervoltage Lockout Level

The device offers an adjustable input undervoltage-lockout level. Set the voltage at which the device turns on with a resistive voltage-divider connected from V_{IN} to GND (see [Figure 2](#)). Connect the center node of the divider to EN/UVLO.

Choose R1 to be 3.3MΩ, and then calculate R2 as:

$$R2 = \frac{R1 \times 1.218}{(V_{INU} - 1.218)}$$

where V_{INU} is the voltage at which the device is required to turn on. For adjustable output voltage devices, ensure that V_{INU} is higher than 0.8 x V_{OUT}.

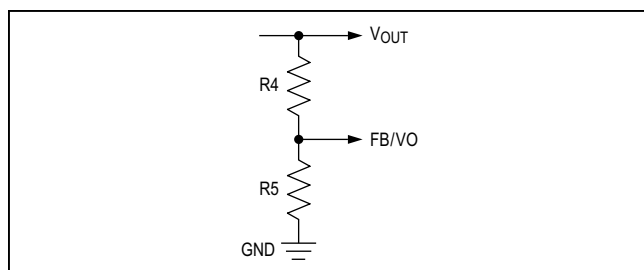

Figure 1. Setting the Output Voltage

External Loop Compensation for Adjustable Output Versions

The MAX17502 uses peak current-mode control scheme and needs only a simple RC network to have a stable, high-bandwidth control loop for the adjustable output voltage versions. The basic regulator loop is modeled as a power modulator, an output feedback divider, and an error amplifier. The power modulator has DC gain G_{MOD(dc)}, with a pole and zero pair. The following equation defines the power modulator DC gain:

$$G_{MOD(dc)} = \frac{2}{\frac{1}{R_{LOAD}} + \frac{0.4}{V_{IN}} + \left(\frac{0.5 - D}{f_{SW} \times L_{SEL}} \right)}$$

where R_{LOAD} = V_{OUT}/I_{OUT(MAX)}, f_{SW} is the switching frequency, L_{SEL} is the selected output inductance, D is the duty ratio, D = V_{OUT}/V_{IN}.

The compensation network is shown in [Figure 3](#).

R_Z can be calculated as:

$$R_Z = 6000 \times f_C \times C_{SEL} \times V_{OUT}$$

where R_Z is in Ω. Choose f_C to be 1/12th of the switching frequency.

C_Z can be calculated as follows:

$$C_Z = \frac{C_{SEL} \times G_{MOD(dc)}}{2 \times R_Z}$$

C_P can be calculated as follows:

$$C_P = \frac{1}{\pi \times R_Z \times f_{SW}}$$

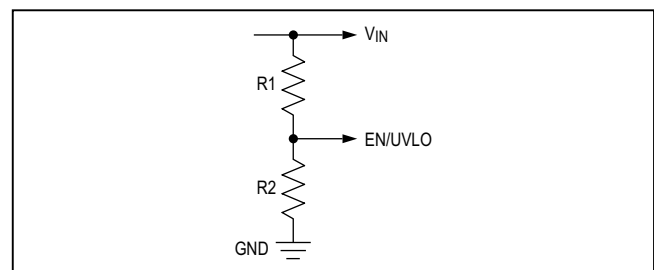

Figure 2. Adjustable EN/UVLO Network

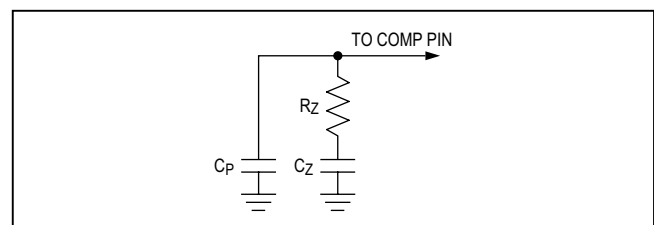

Figure 3. External Compensation Network

Power Dissipation

At a particular operating condition, the power losses that lead to temperature rise of the device are estimated as follows:

$$P_{\text{LOSS}} = (P_{\text{OUT}} \times (\frac{1}{\eta} - 1)) - (I_{\text{OUT}}^2 \times R_{\text{DCR}})$$

$$P_{\text{OUT}} = V_{\text{OUT}} \times I_{\text{OUT}}$$

where P_{OUT} is the output power, η is the efficiency of the device, and R_{DCR} is the DC resistance of the output inductor (refer to the *Typical Operating Characteristics* in the evaluation kit data sheets for more information on efficiency at typical operating conditions).

For a typical multilayer board, the thermal performance metrics for the 10-pin TDFN package are given as:

$$\theta_{\text{JA}} = 67.3^\circ\text{C/W}$$

$$\theta_{\text{JC}} = 18.2^\circ\text{C/W}$$

For a typical multilayer board, the thermal performance metrics for the 14-pin TSSOP package are given as:

$$\theta_{\text{JA}} = 39^\circ\text{C/W}$$

$$\theta_{\text{JC}} = 3^\circ\text{C/W}$$

The junction temperature of the device can be estimated at any given maximum ambient temperature ($T_{\text{A_MAX}}$) from the following equation:

$$T_{\text{J_MAX}} = T_{\text{A_MAX}} + (\theta_{\text{JA}} \times P_{\text{LOSS}})$$

If the application has a thermal-management system that ensures that the exposed pad of the device is maintained at a given temperature ($T_{\text{EP_MAX}}$) by using proper heat sinks, then the junction temperature of the device can be estimated at any given maximum ambient temperature as:

$$T_{\text{J_MAX}} = T_{\text{EP_MAX}} + (\theta_{\text{JC}} \times P_{\text{LOSS}})$$

Junction temperature greater than $+125^\circ\text{C}$ degrades operating lifetimes.

PCB Layout Guidelines

Careful PCB layout is critical to achieve low switching losses and stable operation. For a sample layout that ensures first-pass success, refer to the MAX17502 evaluation kit layouts available at www.maximintegrated.com. Follow these guidelines for good PCB layout:

- 1) All connections carrying pulsed currents must be very short and as wide as possible. The loop area of these connections must be made very small to reduce stray inductance and radiated EMI.
- 2) A ceramic input filter capacitor should be placed close to the V_{IN} pin of the device. The bypass capacitor for the V_{CC} pin should also be placed close to the V_{CC} pin. External compensation components should be placed close to the IC and far from the inductor. The feedback trace should be routed as far as possible from the inductor.
- 3) The analog small-signal ground and the power ground for switching currents must be kept separate. They should be connected together at a point where switching activity is at minimum, typically the return terminal of the V_{CC} bypass capacitor. The ground plane should be kept continuous as much as possible.
- 4) A number of thermal throughputs that connect to a large ground plane should be provided under the exposed pad of the device, for efficient heat dissipation.

[Figure 4](#), [5](#), and [6](#) show the recommended component placement for MAX17502 in TDFN and TSSOP packages.

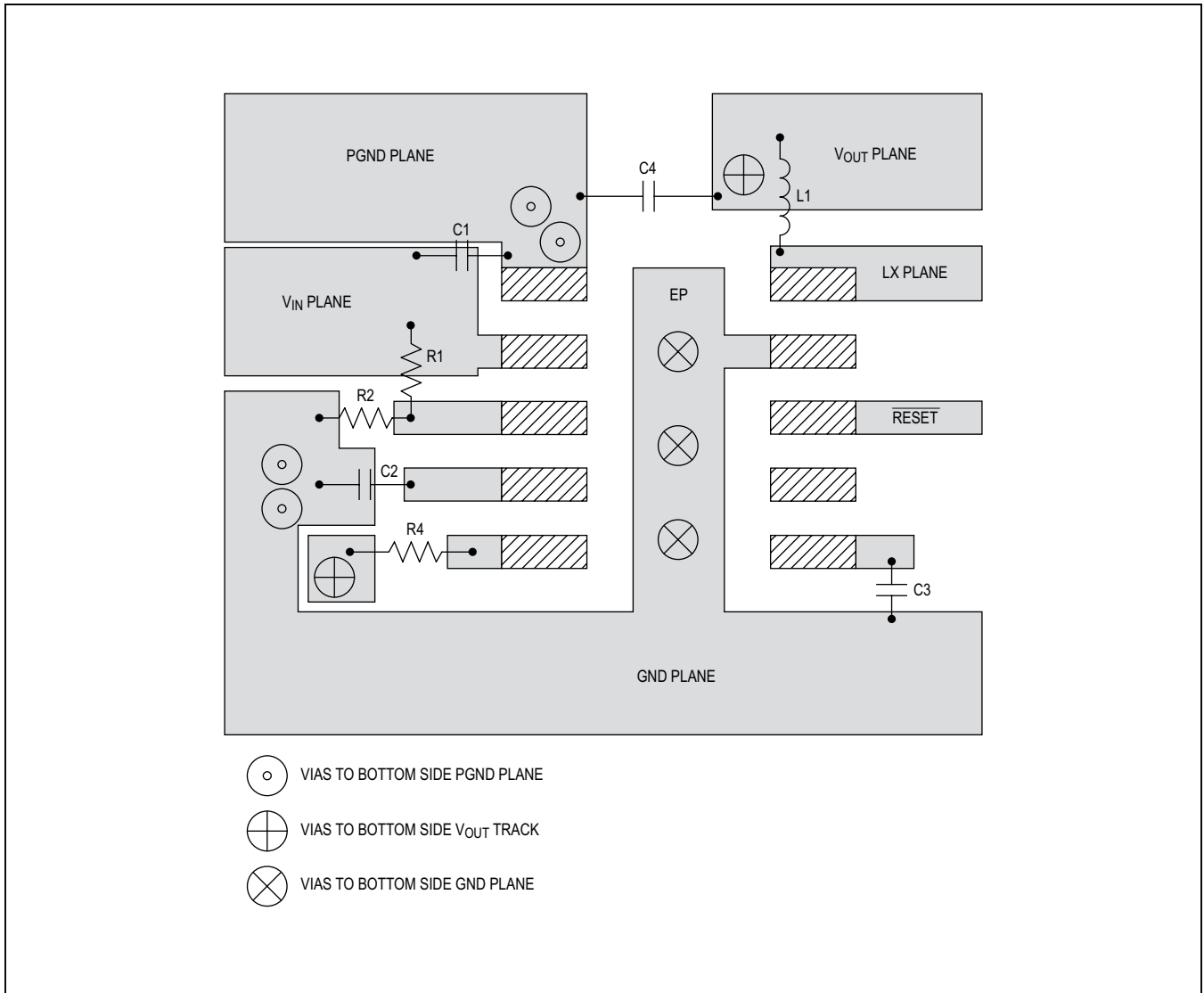

Figure 4. Recommended Component Placement for MAX17502E/F

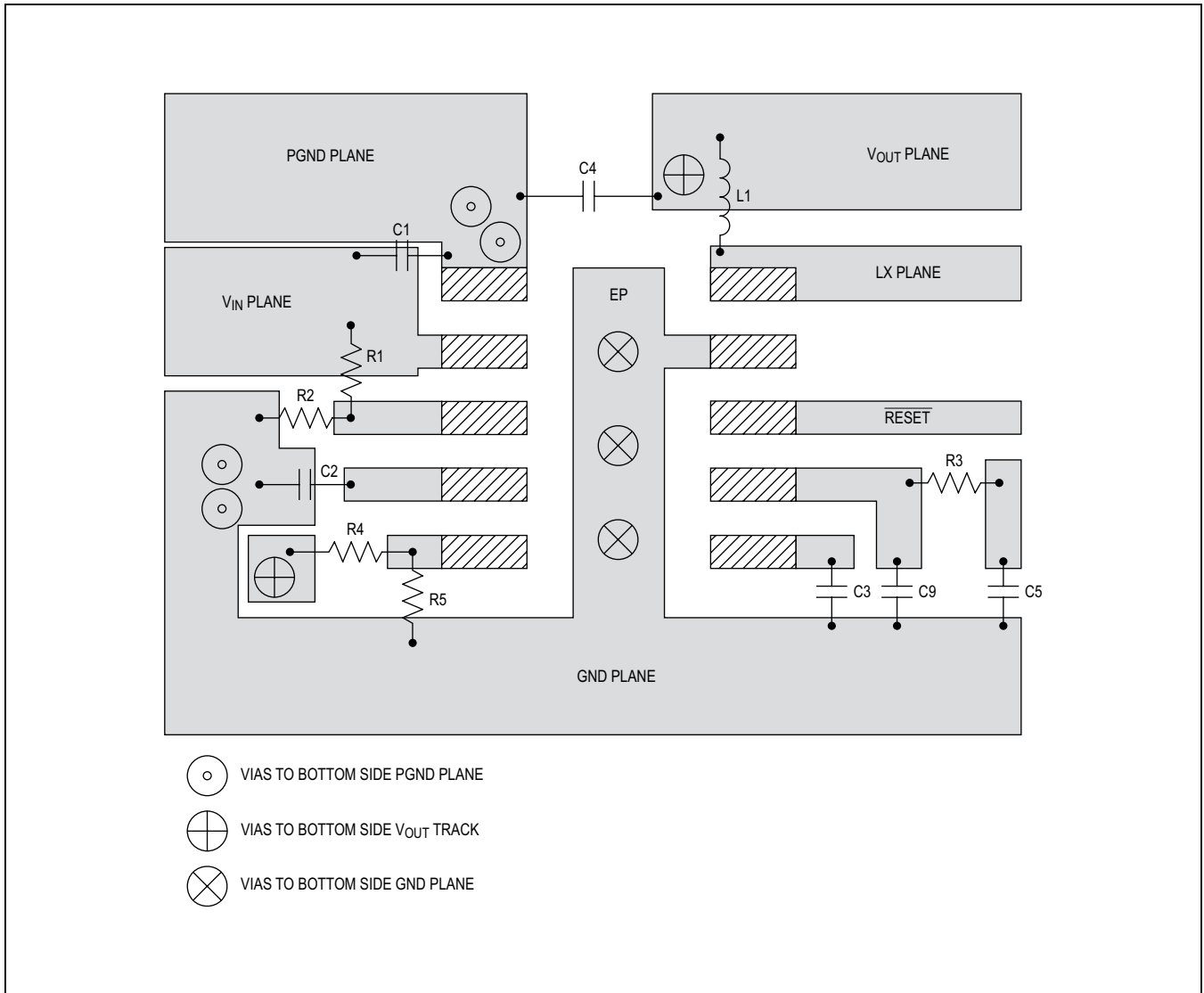

Figure 5. Recommended Component Placement for MAX17502G

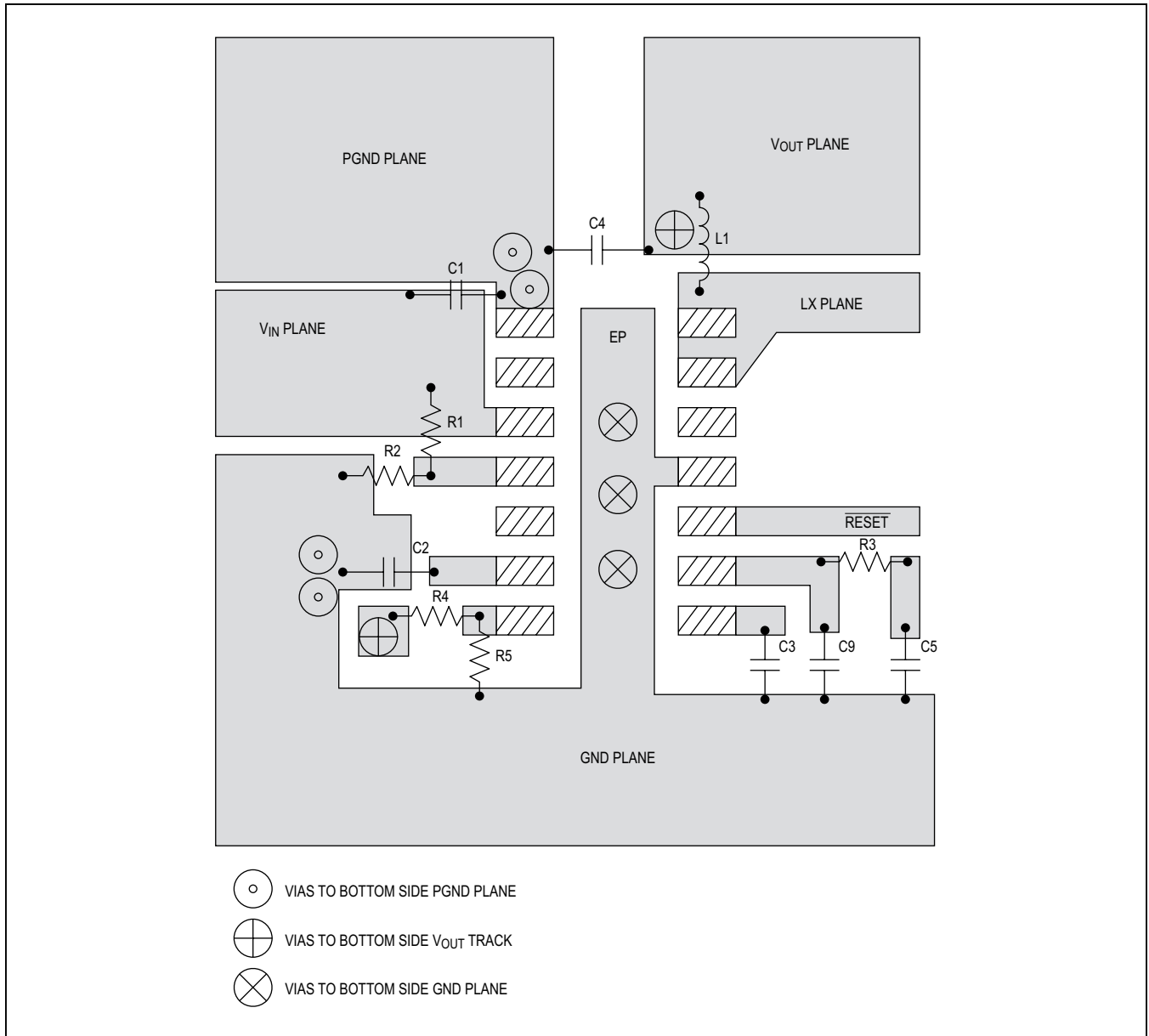

Figure 6. Recommended Component Placement for MAX17502H

Typical Applications Circuits

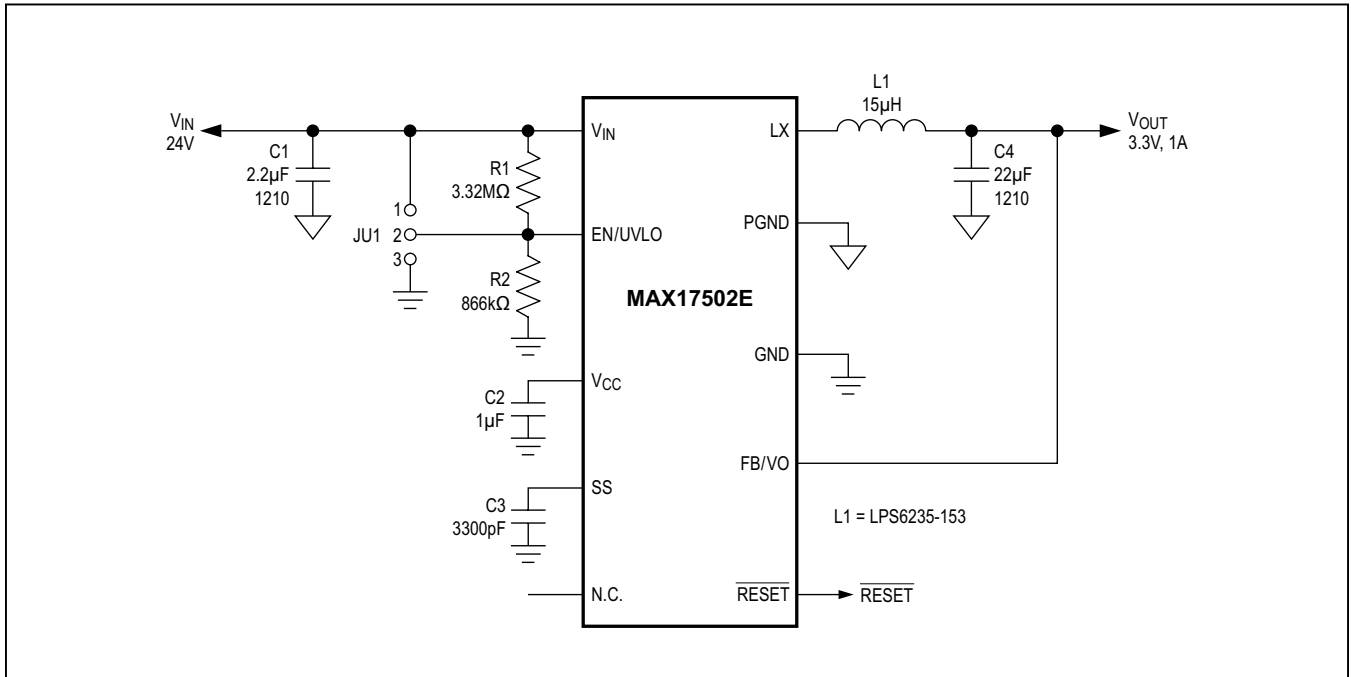

Figure 7. MAX17502E Application Circuit (3.3V Output, 1A Maximum Load Current, 600kHz Switching Frequency)

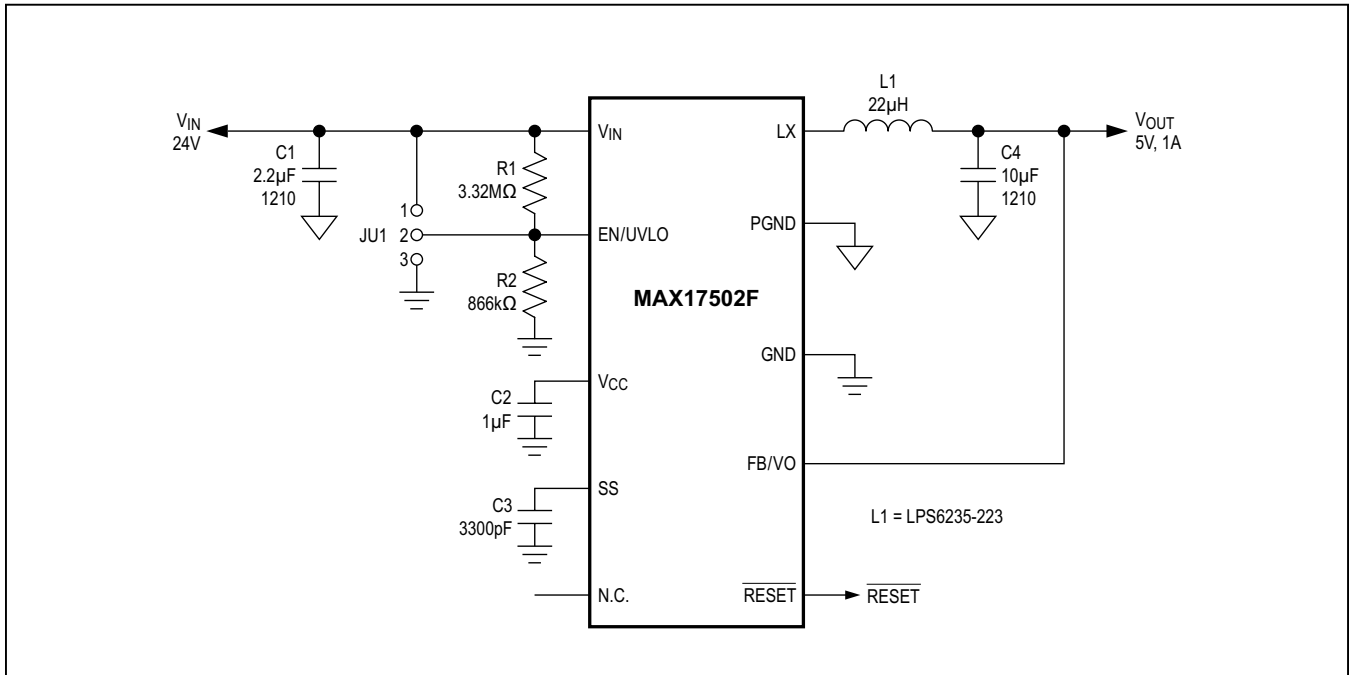

Figure 8. MAX17502F Application Circuit (5V Output, 1A Maximum Load Current, 600kHz Switching Frequency)

MAX17502

60V, 1A, Ultra-Small, High-Efficiency, Synchronous Step-Down DC-DC Converter

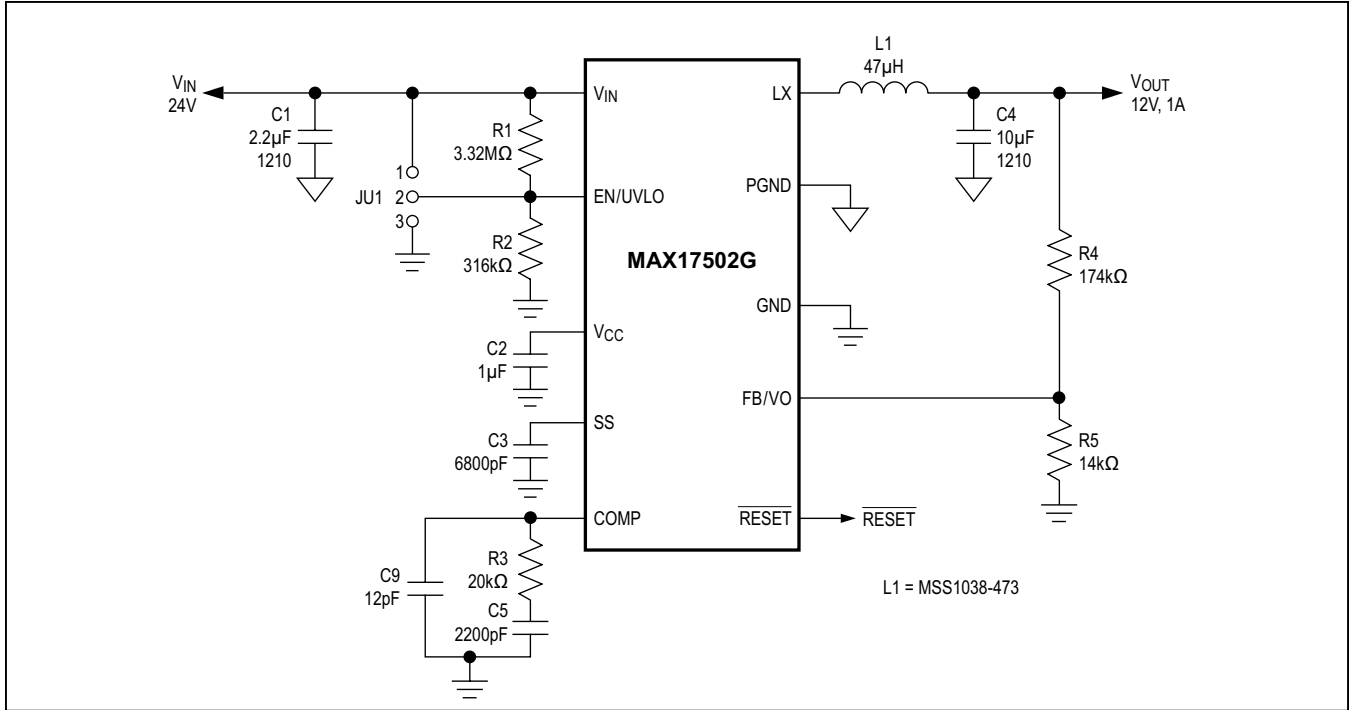

Figure 9. MAX17502G Application Circuit (12V Output, 1A Maximum Load Current, 600kHz Switching Frequency)

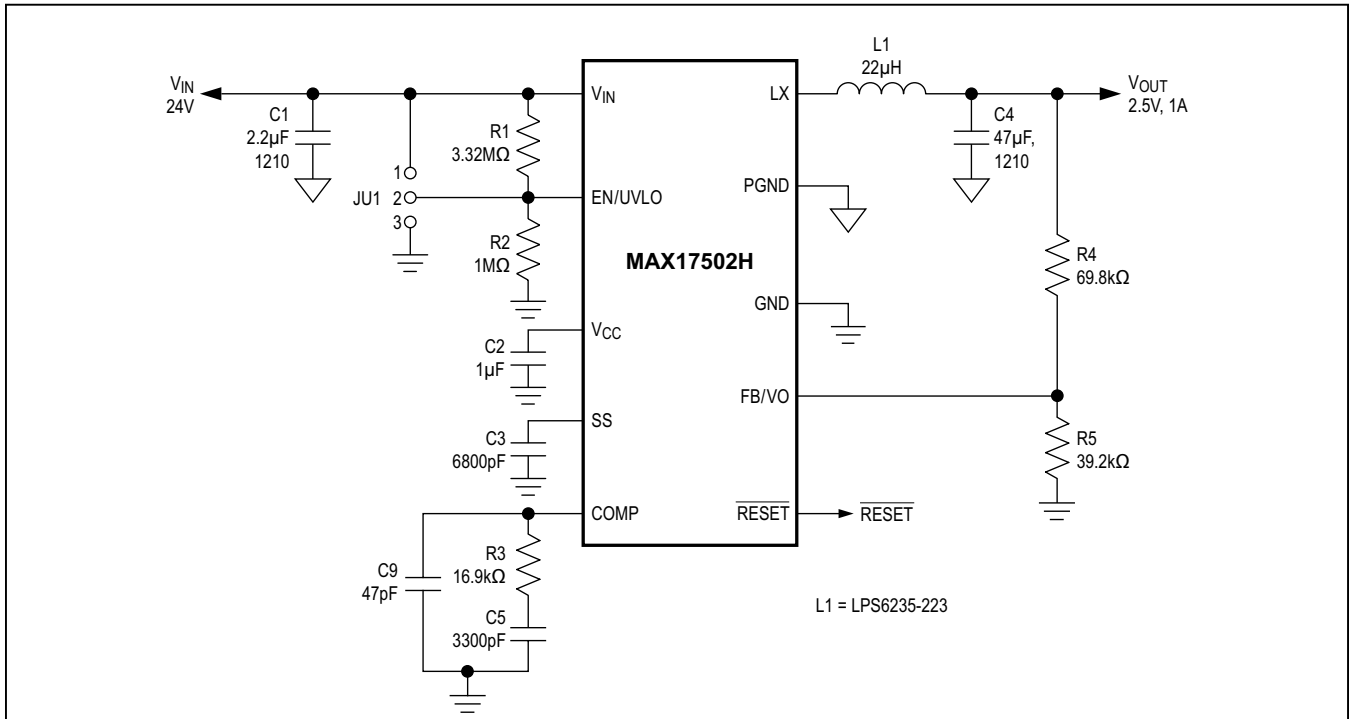

Figure 10. MAX17502H Application Circuit (2.5V Output, 1A Maximum Load Current, 300kHz Switching Frequency)

MAX17502

60V, 1A, Ultra-Small, High-Efficiency,
Synchronous Step-Down DC-DC Converter

Ordering Information/Selector Guide

| PART | PIN-PACKAGE | OUTPUT VOLTAGE (V) | SWITCHING FREQUENCY (kHz) | MODE |
|---------------|--------------|--------------------|---------------------------|------|
| MAX17502EATB+ | 10 TDFN-EP* | 3.3 | 600 | PWM |
| MAX17502FATB+ | 10 TDFN-EP* | 5 | 600 | PWM |
| MAX17502GATB+ | 10 TDFN-EP* | Adjustable | 600 | PWM |
| MAX17502HAUD+ | 14 TSSOP-EP* | Adjustable | 300 | PWM |

+Denotes a lead(Pb)-free/RoHS-compliant package.

*EP = Exposed pad.

Chip Information

PROCESS: BiCMOS

Package Information

For the latest package outline information and land patterns (footprints), go to www.maximintegrated.com/packages. Note that a "+", "#", or "-" in the package code indicates RoHS status only. Package drawings may show a different suffix character, but the drawing pertains to the package regardless of RoHS status.

| PACKAGE TYPE | PACKAGE CODE | OUTLINE NO. | LAND PATTERN NO. |
|--------------|--------------|-------------------------|-------------------------|
| 10 TDFN | T1032N+1 | 21-0429 | 90-0082 |
| 14 TSSOP | U14E+3 | 21-0108 | 90-0119 |

Revision History

| REVISION NUMBER | REVISION DATE | DESCRIPTION | PAGES CHANGED |
|-----------------|---------------|--|---------------------|
| 0 | 5/12 | Initial release | — |
| 1 | 11/12 | Added MAX17502G and MAX17502H to data sheet | 1–17 |
| 2 | 1/13 | Added dotted line for exposed pad in <i>Pin Configuration</i> , and added explanation on detailed condition for RESET | 9, 11 |
| 3 | 8/14 | Updated <i>General Description</i> , <i>Benefits and Features</i> , <i>Pin Description</i> , and <i>Adjusting Output Voltage</i> sections. | 1, 9, 13 |
| 4 | 6/15 | Added output voltage to TOC captions | 8–12, 16–18, 22, 23 |
| 5 | 6/16 | Updated operating and junction temperature values | 1–8, 14, 19 |

For pricing, delivery, and ordering information, please contact Maxim Direct at 1-888-629-4642, or visit Maxim Integrated's website at www.maximintegrated.com.

Maxim Integrated cannot assume responsibility for use of any circuitry other than circuitry entirely embodied in a Maxim Integrated product. No circuit patent licenses are implied. Maxim Integrated reserves the right to change the circuitry and specifications without notice at any time. The parametric values (min and max limits) shown in the Electrical Characteristics table are guaranteed. Other parametric values quoted in this data sheet are provided for guidance.

Mouser Electronics

Authorized Distributor

Click to View Pricing, Inventory, Delivery & Lifecycle Information:

Analog Devices Inc.:

[MAX17502GATB+](#) [MAX17502FATB+](#) [MAX17502HAUD+](#) [MAX17502HAUD+T](#) [MAX17502EATB+T](#)
[MAX17502FTEVKIT#](#) [MAX17502ETEVKIT#](#) [MAX17502GATB+T](#)

Other:

[MAX17502EATB+](#) [MAX17502FATB+T](#)