



Click [here](#) to ask an associate for production status of specific part numbers.

## Two-Channel, Low-Power, 3kV<sub>RMS</sub> and 5kV<sub>RMS</sub> Digital Isolators

## MAX12930/MAX12931

### General Description

The MAX12930/MAX12931 are a family of 2-channel, 3kV/5kV<sub>RMS</sub> digital galvanic isolators using Maxim's proprietary process technology. These devices transfer digital signals between circuits with different power domains while using as little as 0.65mW per channel at 2Mbps with 1.8V.

The two channels of the MAX12931 transfer data in opposite directions, and this makes the MAX12931 ideal for isolating the TX and RX lines of a transceiver. The MAX12930 features two channels transferring data in the same direction.

Both devices are available with a maximum data rate of either 25Mbps or 150Mbps and with the default outputs that are either high or low. The default is the state the output assumes when the input is not powered, or if the input is open-circuit. See the [Ordering Information](#) and [Product Selector Guide](#) for suffixes associated with each option. Independent 1.71V to 5.5V supplies on each side of the isolator also make the devices suitable for use as level translators.

The MAX12930/MAX12931 are available in an 8-pin, narrow-body SOIC package. In addition, the MAX12931 is available in a 16-pin, wide-body SOIC package. The package material of the 8-pin narrow-body SOIC package has a minimum comparative tracking index (CTI) of 400, which gives it a group II rating in creepage tables. The package material of the 16-pin wide-body SOIC package has a CTI of 600, which gives it a group I rating in creepage tables. All devices are rated for operation at ambient temperatures of -40°C to +125°C.

### Benefits and Features

- Robust Galvanic Isolation of Digital Signals
  - Withstands 5kV<sub>RMS</sub> for 60s (V<sub>ISO</sub>) Wide-Body
  - Withstands 3kV<sub>RMS</sub> for 60s (V<sub>ISO</sub>) Narrow-Body
  - Continuously Withstands 848V<sub>RMS</sub> (V<sub>IOWM</sub>) Wide-Body
  - Continuously Withstands 445V<sub>RMS</sub> (V<sub>IOWM</sub>) Narrow-Body
  - Withstands ±10kV Surge Between GNDA and GNDB with 1.2/50µs Waveform
  - High CMTI (50kV/µs, typ)
- Options to Support a Broad Range of Applications
  - 2 Data Rates (25Mbps/150Mbps)
  - 2 Channel Direction Configurations
  - 2 Output Default States (High or Low)
- Low Power Consumption
  - 1.3mW per Channel at 2Mbps with V<sub>DD</sub> = 3.3V
  - 3.3mW per Channel at 100Mbps with V<sub>DD</sub> = 1.8V

### Safety Regulatory Approvals

(see [Safety Regulatory Approvals](#))

- UL According to UL1577
- cUL According to CSA Bulletin 5A
- VDE 0884-11 Basic Insulation (Narrow SOIC)

### Applications

- Fieldbus Communications for Industrial Automation
- Isolated RS232, RS-485/RS-422, CAN
- General Isolation Application
- Battery Management
- Medical Systems

[Ordering Information](#) and [Product Selector Guide](#) appear at end of data sheet.

### Functional Diagrams

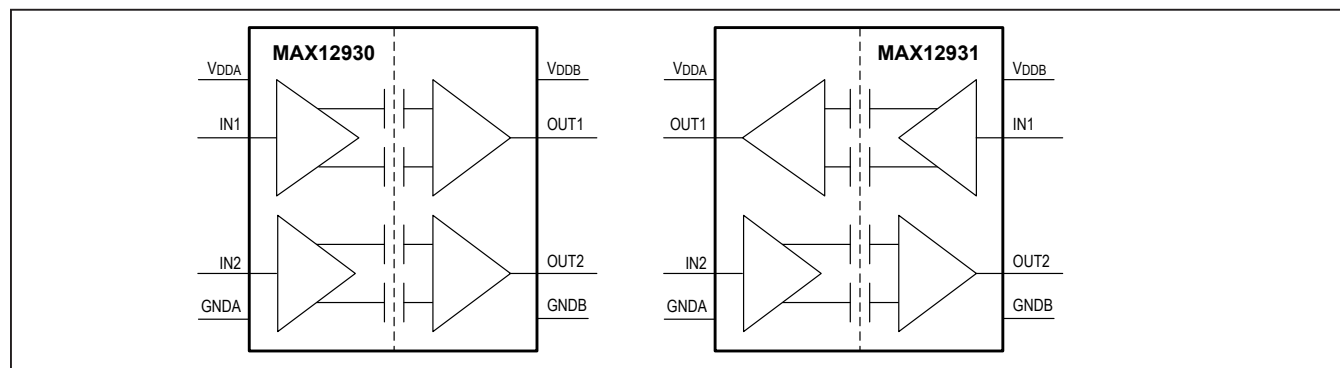

19-8563; Rev 10; 8/21

## Absolute Maximum Ratings

V <sub>DDA</sub> to GNDA.....	-0.3V to +6V
V <sub>DDB</sub> to GNDB.....	-0.3V to +6V
IN_ on Side A to GNDA.....	-0.3V to +6V
IN_ on Side B to GNDB.....	-0.3V to +6V
OUT_ on Side A to GNDA.....	-0.3V to V <sub>DDA</sub> + 0.3V
OUT_ on Side B to GNDB.....	-0.3V to V <sub>DDB</sub> + 0.3V
Short-Circuit Duration	
OUT_ on Side A to GNDA,	
OUT_ on Side B to GNDB.....	Continuous

Continuous Power Dissipation (T <sub>A</sub> = +70°C)	
Wide SOIC (derate 14.1mW/°C above +70°C) .....	1126.8mW
Narrow SOIC (derate 5.79mW/°C above +70°C).....	462.96mW
Operating Temperature Range.....	-40°C to +125°C
Maximum Junction Temperature .....	+150°C
Storage Temperature Range.....	-60°C to +150°C
Soldering Temperature (reflow).....	+260°C

Stresses beyond those listed under "Absolute Maximum Ratings" may cause permanent damage to the device. These are stress ratings only, and functional operation of the device at these or any other conditions beyond those indicated in the operational sections of the specifications is not implied. Exposure to absolute maximum rating conditions for extended periods may affect device reliability.

## Package Information

<b>PACKAGE TYPE: 8 NARROW SOIC</b>	
Package Code	S8MS-22
Outline Number	<a href="#">21-0041</a>
Land Pattern Number	<a href="#">90-0096</a>
<b>THERMAL RESISTANCE, FOUR-LAYER BOARD</b>	
Junction to Ambient (θ <sub>JA</sub> )	172.8°C/W
Junction to Case (θ <sub>JC</sub> )	67.6°C/W

<b>PACKAGE TYPE: 16 WIDE SOIC</b>	
Package Code	W16MS-11
Outline Number	<a href="#">21-0042</a>
Land Pattern Number	<a href="#">90-0107</a>
<b>THERMAL RESISTANCE, FOUR-LAYER BOARD</b>	
Junction to Ambient (θ <sub>JA</sub> )	71°C/W
Junction to Case (θ <sub>JC</sub> )	23°C/W

For the latest package outline information and land patterns (footprints), go to [www.maximintegrated.com/packages](http://www.maximintegrated.com/packages). Note that a "+", "#", or "-" in the package code indicates RoHS status only. Package drawings may show a different suffix character, but the drawing pertains to the package regardless of RoHS status.

Package thermal resistances were obtained using the method described in JEDEC specification JESD51-7, using a four-layer board. For detailed information on package thermal considerations, refer to [www.maximintegrated.com/thermal-tutorial](http://www.maximintegrated.com/thermal-tutorial).

DC Electrical Characteristics

(V<sub>DDA</sub> - V<sub>GNDA</sub> = 1.71V to 5.5V, V<sub>DDB</sub> - V<sub>GNDB</sub> = 1.71V to 5.5V, C<sub>L</sub> = 15pF, T<sub>A</sub> = -40°C to +125°C, unless otherwise noted. Typical values are at V<sub>DDA</sub> - V<sub>GNDA</sub> = 3.3V, V<sub>DDB</sub> - V<sub>GNDB</sub> = 3.3V, GNDA = GNDB, T<sub>A</sub> = 25°C, unless otherwise noted.) (Note 1)

PARAMETER	SYMBOL	CONDITIONS	MIN	TYP	MAX	UNITS
<b>POWER SUPPLY</b>						
Supply Voltage	V <sub>DDA</sub>	Relative to GNDA	1.71		5.5	V
	V <sub>DDB</sub>	Relative to GNDB	1.71		5.5	
Undervoltage-Lockout Threshold	V <sub>UVLO_</sub>	V <sub>DD_</sub> rising	1.5	1.6	1.66	V
Undervoltage-Lockout Threshold Hysteresis	V <sub>UVLO_HYST</sub>			45		mV
Supply Current (MAX12930_) (Note 2)	I <sub>DDA</sub>	1MHz square wave, C <sub>L</sub> = 0pF	V <sub>DDA</sub> = 5V	0.32	0.58	mA
			V <sub>DDA</sub> = 3.3V	0.31	0.54	
			V <sub>DDA</sub> = 2.5V	0.3	0.53	
			V <sub>DDA</sub> = 1.8V	0.29	0.39	
		12.5MHz square wave, C <sub>L</sub> = 0pF	V <sub>DDA</sub> = 5V	0.81	1.26	
			V <sub>DDA</sub> = 3.3V	0.8	1.20	
			V <sub>DDA</sub> = 2.5V	0.78	1.18	
			V <sub>DDA</sub> = 1.8V	0.77	1.01	
		50MHz square wave, C <sub>L</sub> = 0pF	V <sub>DDA</sub> = 5V	2.15	3.00	
			V <sub>DDA</sub> = 3.3V	2.09	2.91	
			V <sub>DDA</sub> = 2.5V	2.06	2.88	
			V <sub>DDA</sub> = 1.8V	2	2.62	
	I <sub>DDB</sub>	1MHz square wave, C <sub>L</sub> = 0pF	V <sub>DDB</sub> = 5V	0.5	0.83	mA
			V <sub>DDB</sub> = 3.3V	0.47	0.79	
			V <sub>DDB</sub> = 2.5V	0.45	0.76	
			V <sub>DDB</sub> = 1.8V	0.4	0.67	
		12.5MHz square wave, C <sub>L</sub> = 0pF	V <sub>DDB</sub> = 5V	1.37	1.83	
			V <sub>DDB</sub> = 3.3V	1.02	1.40	
			V <sub>DDB</sub> = 2.5V	0.87	1.22	
			V <sub>DDB</sub> = 1.8V	0.71	1.00	
		50MHz square wave, C <sub>L</sub> = 0pF	V <sub>DDB</sub> = 5V	4.21	4.99	
			V <sub>DDB</sub> = 3.3V	2.81	3.39	
			V <sub>DDB</sub> = 2.5V	2.21	2.69	
			V <sub>DDB</sub> = 1.8V	1.69	2.04	

DC Electrical Characteristics (continued)

(V<sub>DDA</sub> - V<sub>GNDA</sub> = 1.71V to 5.5V, V<sub>DDB</sub> - V<sub>GNDB</sub> = 1.71V to 5.5V, C<sub>L</sub> = 15pF, T<sub>A</sub> = -40°C to +125°C, unless otherwise noted. Typical values are at V<sub>DDA</sub> - V<sub>GNDA</sub> = 3.3V, V<sub>DDB</sub> - V<sub>GNDB</sub> = 3.3V, GNDA = GNDB, T<sub>A</sub> = 25°C, unless otherwise noted.) (Note 1)

PARAMETER	SYMBOL	CONDITIONS	MIN	TYP	MAX	UNITS
Supply Current (MAX12931_) (Note 2)	I <sub>DDA</sub>	1MHz square wave, C <sub>L</sub> = 0pF	V <sub>DDA</sub> = 5V	0.42	0.70	mA
			V <sub>DDA</sub> = 3.3V	0.39	0.67	
			V <sub>DDA</sub> = 2.5V	0.38	0.64	
			V <sub>DDA</sub> = 1.8V	0.36	0.56	
		12.5MHz square wave, C <sub>L</sub> = 0pF	V <sub>DDA</sub> = 5V	1.07	1.52	
			V <sub>DDA</sub> = 3.3V	0.89	1.29	
			V <sub>DDA</sub> = 2.5V	0.81	1.19	
			V <sub>DDA</sub> = 1.8V	0.73	1.03	
		50MHz square wave, C <sub>L</sub> = 0pF	V <sub>DDA</sub> = 5V	3.06	3.87	
			V <sub>DDA</sub> = 3.3V	2.37	3.06	
			V <sub>DDA</sub> = 2.5V	2.08	2.72	
			V <sub>DDA</sub> = 1.8V	1.82	2.33	
	I <sub>DDB</sub>	1MHz square wave, C <sub>L</sub> = 0pF	V <sub>DDB</sub> = 5V	0.42	0.70	
			V <sub>DDB</sub> = 3.3V	0.39	0.67	
			V <sub>DDB</sub> = 2.5V	0.38	0.64	
			V <sub>DDB</sub> = 1.8V	0.36	0.56	
		12.5MHz square wave, C <sub>L</sub> = 0pF	V <sub>DDB</sub> = 5V	1.07	1.52	
			V <sub>DDB</sub> = 3.3V	0.89	1.29	
			V <sub>DDB</sub> = 2.5V	0.81	1.19	
			V <sub>DDB</sub> = 1.8V	0.73	1.03	
		50MHz square wave, C <sub>L</sub> = 0pF	V <sub>DDB</sub> = 5V	3.06	3.87	
			V <sub>DDB</sub> = 3.3V	2.37	3.06	
			V <sub>DDB</sub> = 2.5V	2.08	2.72	
			V <sub>DDB</sub> = 1.8V	1.82	2.33	
<b>LOGIC INPUTS AND OUTPUTS</b>						
Input High Voltage	V <sub>IH</sub>	2.25V ≤ V <sub>DD_</sub> ≤ 5.5V	0.7 x V <sub>DD_</sub>			V
		1.71V ≤ V <sub>DD_</sub> < 2.25V	0.75 x V <sub>DD_</sub>			
Input Low Voltage	V <sub>IL</sub>	2.25V ≤ V <sub>DD_</sub> ≤ 5.5V	0.8			V
		1.71V ≤ V <sub>DD_</sub> < 2.25V	0.7			
Input Hysteresis	V <sub>HYS</sub>	MAX1293_B/E	410			mV
		MAX1293_C/F	80			
Input Pullup Current (Note 3)	I <sub>PU</sub>	IN_, MAX1293_B/C	-10	-5	-1.5	μA
Input Pulldown Current (Note 3)	I <sub>PD</sub>	IN_, MAX1293_E/F	1.5	5	10	μA
Input Capacitance	C <sub>IN</sub>	IN_, f <sub>SW</sub> = 1MHz	2			pF

# MAX12930/MAX12931

## Two-Channel, Low-Power, 3kV<sub>RMS</sub> and 5kV<sub>RMS</sub> Digital Isolators

### DC Electrical Characteristics (continued)

(V<sub>DDA</sub> - V<sub>GNDA</sub> = 1.71V to 5.5V, V<sub>DDB</sub> - V<sub>GNDB</sub> = 1.71V to 5.5V, C<sub>L</sub> = 15pF, T<sub>A</sub> = -40°C to +125°C, unless otherwise noted. Typical values are at V<sub>DDA</sub> - V<sub>GNDA</sub> = 3.3V, V<sub>DDB</sub> - V<sub>GNDB</sub> = 3.3V, G<sub>NDA</sub> = G<sub>NDB</sub>, T<sub>A</sub> = 25°C, unless otherwise noted.) (Note 1)

PARAMETER	SYMBOL	CONDITIONS	MIN	TYP	MAX	UNITS
Output Voltage High (Note 3)	V <sub>OH</sub>	I <sub>OUT</sub> = 4mA source	V <sub>DD_</sub> - 0.4			V
Output Voltage Low (Note 3)	V <sub>OL</sub>	I <sub>OUT</sub> = 4mA sink			0.4	V

### Dynamic Characteristics MAX1293\_B/E

(V<sub>DDA</sub> - V<sub>GNDA</sub> = 1.71V to 5.5V, V<sub>DDB</sub> - V<sub>GNDB</sub> = 1.71V to 5.5V, C<sub>L</sub> = 15pF, T<sub>A</sub> = -40°C to +125°C, unless otherwise noted. Typical values are at V<sub>DDA</sub> - V<sub>GNDA</sub> = 3.3V, V<sub>DDB</sub> - V<sub>GNDB</sub> = 3.3V, G<sub>NDA</sub> = G<sub>NDB</sub>, T<sub>A</sub> = 25°C, unless otherwise noted.) (Notes 1, 2)

PARAMETER	SYMBOL	CONDITIONS	MIN	TYP	MAX	UNITS	
Common-Mode Transient Immunity	CMTI	IN_ = GND_ or V <sub>DD_</sub> (Note 4)		50		kV/μs	
Maximum Data Rate	DR <sub>MAX</sub>		25			Mbps	
Minimum Pulse Width	PW <sub>MIN</sub>				40	ns	
Glitch Rejection			10	17	29	ns	
Propagation Delay (Figure 1)	t <sub>PLH</sub>	4.5V ≤ V <sub>DD_</sub> ≤ 5.5V	17.4	23.9	32.5	ns	
		3.0V ≤ V <sub>DD_</sub> ≤ 3.6V	17.6	24.4	33.7		
		2.25V ≤ V <sub>DD_</sub> ≤ 2.75V	18.3	25.8	36.7		
		1.71V ≤ V <sub>DD_</sub> ≤ 1.89V	20.7	29.6	43.5		
	t <sub>PHL</sub>	4.5V ≤ V <sub>DD_</sub> ≤ 5.5V	16.9	23.4	33.6		
		3.0V ≤ V <sub>DD_</sub> ≤ 3.6V	17.2	24.2	35.1		
		2.25V ≤ V <sub>DD_</sub> ≤ 2.75V	17.8	25.4	38.2		
		1.71V ≤ V <sub>DD_</sub> ≤ 1.89V	19.8	29.3	45.8		
Pulse Width Distortion	PWD		0.4	4	ns		
Propagation Delay Skew Part-to-Part (same channel)	t <sub>SPLH</sub>	4.5V ≤ V <sub>DD_</sub> ≤ 5.5V			15.1	ns	
		3.0V ≤ V <sub>DD_</sub> ≤ 3.6V			15		
		2.25V ≤ V <sub>DD_</sub> ≤ 2.75V			15.4		
		1.71V ≤ V <sub>DD_</sub> ≤ 1.89V			20.5		
	t <sub>SPHL</sub>	4.5V ≤ V <sub>DD_</sub> ≤ 5.5V					13.9
		3.0V ≤ V <sub>DD_</sub> ≤ 3.6V					14.2
		2.25V ≤ V <sub>DD_</sub> ≤ 2.75V					16
		1.71V ≤ V <sub>DD_</sub> ≤ 1.89V					21.8
Propagation Delay Skew Chan- nel-to-Channel (Same Direction) (MAX12930 only)	t <sub>SCSLH</sub>				2	ns	
	t <sub>SCSHL</sub>				2		

**Dynamic Characteristics MAX1293\_B/E (continued)**

(V<sub>DDA</sub> - V<sub>GNDA</sub> = 1.71V to 5.5V, V<sub>DDB</sub> - V<sub>GNDB</sub> = 1.71V to 5.5V, C<sub>L</sub> = 15pF, T<sub>A</sub> = -40°C to +125°C, unless otherwise noted. Typical values are at V<sub>DDA</sub> - V<sub>GNDA</sub> = 3.3V, V<sub>DDB</sub> - V<sub>GNDB</sub> = 3.3V, G<sub>NDA</sub> = G<sub>NDB</sub>, T<sub>A</sub> = 25°C, unless otherwise noted.) (Notes 1, 2)

PARAMETER	SYMBOL	CONDITIONS	MIN	TYP	MAX	UNITS
Propagation Delay Skew Channel-to-Channel (Opposite Direction) (MAX12931 only)	t <sub>SCOLH</sub>				2	ns
	t <sub>SCOHL</sub>				2	
Peak Eye Diagram Jitter	T <sub>JIT(PK)</sub>	25Mbps		250		ps
Rise Time ( <a href="#">Figure 1</a> )	t <sub>R</sub>	4.5V ≤ V <sub>DD_</sub> ≤ 5.5V			1.6	ns
		3.0V ≤ V <sub>DD_</sub> ≤ 3.6V			2.2	
		2.25V ≤ V <sub>DD_</sub> ≤ 2.75V			3	
		1.71V ≤ V <sub>DD_</sub> ≤ 1.89V			4.5	
Fall Time ( <a href="#">Figure 1</a> )	t <sub>F</sub>	4.5V ≤ V <sub>DD_</sub> ≤ 5.5V			1.4	ns
		3.0V ≤ V <sub>DD_</sub> ≤ 3.6V			2	
		2.25V ≤ V <sub>DD_</sub> ≤ 2.75V			2.8	
		1.71V ≤ V <sub>DD_</sub> ≤ 1.89V			5.1	

Dynamic Characteristics MAX1293\_C/F

(V<sub>DDA</sub> - V<sub>GNDA</sub> = 1.71V to 5.5V, V<sub>DDB</sub> - V<sub>GNDB</sub> = 1.71V to 5.5V, C<sub>L</sub> = 15pF, T<sub>A</sub> = -40°C to +125°C, unless otherwise noted. Typical values are at V<sub>DDA</sub> - V<sub>GNDA</sub> = 3.3V, V<sub>DDB</sub> - V<sub>GNDB</sub> = 3.3V, G<sub>NDA</sub> = G<sub>NDB</sub>, T<sub>A</sub> = 25°C, unless otherwise noted.) (Notes 2,3)

PARAMETER	SYMBOL	CONDITIONS	MIN	TYP	MAX	UNITS
Common-Mode Transient Immunity	CMTI	IN <sub>-</sub> = GND <sub>-</sub> or V <sub>DD-</sub> (Note 4)		50		kV/μs
Maximum Data Rate	DR <sub>MAX</sub>		150			Mbps
Minimum Pulse Width	PW <sub>MIN</sub>	2.25V ≤ V <sub>DD-</sub> ≤ 5.5V			5	ns
		1.71V ≤ V <sub>DD-</sub> ≤ 1.89V			6.67	
Propagation Delay (Figure 1)	t <sub>PLH</sub>	4.5V ≤ V <sub>DD-</sub> ≤ 5.5V	4.1	5.4	9.2	ns
		3.0V ≤ V <sub>DD-</sub> ≤ 3.6V	4.2	5.9	10.2	
		2.25V ≤ V <sub>DD-</sub> ≤ 2.75V	4.9	7.1	13.4	
		1.71V ≤ V <sub>DD-</sub> ≤ 1.89V	7.1	10.9	20.3	
	t <sub>PHL</sub>	4.5V ≤ V <sub>DD-</sub> ≤ 5.5V	4.3	5.6	9.4	
		3.0V ≤ V <sub>DD-</sub> ≤ 3.6V	4.4	6.2	10.5	
		2.25V ≤ V <sub>DD-</sub> ≤ 2.75V	5.1	7.3	14.1	
		1.71V ≤ V <sub>DD-</sub> ≤ 1.89V	7.2	10.9	21.7	
Pulse Width Distortion	PWD		0.3	2	ns	
Propagation Delay Skew Part-to-Part (Same Channel)	t <sub>SPLH</sub>	4.5V ≤ V <sub>DD-</sub> ≤ 5.5V			3.7	ns
		3.0V ≤ V <sub>DD-</sub> ≤ 3.6V			4.3	
		2.25V ≤ V <sub>DD-</sub> ≤ 2.75V			6	
		1.71V ≤ V <sub>DD-</sub> ≤ 1.89V			10.3	
	t <sub>SPHL</sub>	4.5V ≤ V <sub>DD-</sub> ≤ 5.5V			3.8	
		3.0V ≤ V <sub>DD-</sub> ≤ 3.6V			4.7	
		2.25V ≤ V <sub>DD-</sub> ≤ 2.75V			6.5	
		1.71V ≤ V <sub>DD-</sub> ≤ 1.89V			11.5	
Propagation Delay Skew Channel-to-Channel (Same Direction) (MAX12930 only)	t <sub>SCSLH</sub>			2	ns	
	t <sub>SCSHL</sub>			2		
Propagation Delay Skew Channel-to-Channel (Opposite Direction) (MAX12931 only)	t <sub>SCOLH</sub>			2	ns	
	t <sub>SCOHL</sub>			2		
Peak Eye Diagram Jitter	t <sub>JIT(PK)</sub>	150Mbps		90	ps	
Clock Jitter RMS	t <sub>JCLK(RMS)</sub>	500kHz Clock Input Rising/Falling Edges		6.5	ps	

Dynamic Characteristics MAX1293\_C/F (continued)

(V<sub>DDA</sub> - V<sub>GNDA</sub> = 1.71V to 5.5V, V<sub>DDB</sub> - V<sub>GNDB</sub> = 1.71V to 5.5V, C<sub>L</sub> = 15pF, T<sub>A</sub> = -40°C to +125°C, unless otherwise noted. Typical values are at V<sub>DDA</sub> - V<sub>GNDA</sub> = 3.3V, V<sub>DDB</sub> - V<sub>GNDB</sub> = 3.3V, G<sub>NDA</sub> = G<sub>NDB</sub>, T<sub>A</sub> = 25°C, unless otherwise noted.) (Notes 2,3)

PARAMETER	SYMBOL	CONDITIONS	MIN	TYP	MAX	UNITS
Rise Time (Figure 1)	t <sub>R</sub>	4.5V ≤ V <sub>DD_</sub> ≤ 5.5V			1.6	ns
		3.0V ≤ V <sub>DD_</sub> ≤ 3.6V			2.2	
		2.25V ≤ V <sub>DD_</sub> ≤ 2.75V			3	
		1.71V ≤ V <sub>DD_</sub> ≤ 1.89V			4.5	
Fall Time (Figure 1)	t <sub>F</sub>	4.5V ≤ V <sub>DD_</sub> ≤ 5.5V			1.4	ns
		3.0V ≤ V <sub>DD_</sub> ≤ 3.6V			2	
		2.25V ≤ V <sub>DD_</sub> ≤ 2.75V			2.8	
		1.71V ≤ V <sub>DD_</sub> ≤ 1.89V			5.1	

- Note 1:** All devices are 100% production tested at T<sub>A</sub> = +25°C. Specifications over temperature are guaranteed by design.
- Note 2:** Not production tested. Guaranteed by design and characterization.
- Note 3:** All currents into the device are positive. All currents out of the device are negative. All voltages are referenced to their respective ground (G<sub>NDA</sub> or G<sub>NDB</sub>), unless otherwise noted.
- Note 4:** CMTI is the maximum sustainable common-mode voltage slew rate while maintaining the correct output. CMTI applies to both rising and falling common-mode voltage sedges. Tested with the transient generator connected between G<sub>NDA</sub> and G<sub>NDB</sub> (V<sub>CM</sub> = 1000V).

ESD Protection

PARAMETER	SYMBOL	CONDITIONS	MIN	TYP	MAX	UNITS
ESD		Human Body Model, all pins		±3		kV

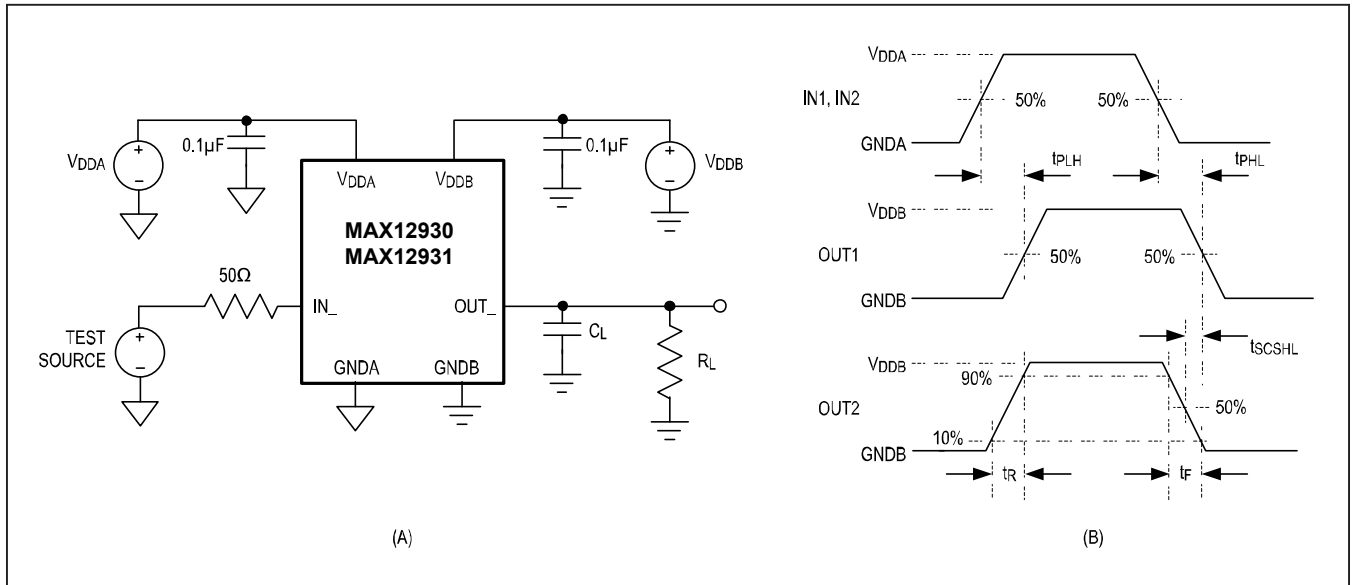

Figure 1. Test Circuit (A) and Timing Diagram (B)



## MAX12930/MAX12931

## Two-Channel, Low-Power, 3kV<sub>RMS</sub> and 5kV<sub>RMS</sub> Digital Isolators

### Safety Regulatory Approvals

<b>UL</b>
The MAX12930–MAX12931 narrow-body SOIC are certified under UL1577. For more details, refer to file E351759.
Rated up to 3000V <sub>RMS</sub> isolation voltage for single protection.
<b>cUL (Equivalent to CSA Notice 5A)</b>
The MAX12930–MAX12931 narrow-body SOIC are certified up to 3000V <sub>RMS</sub> for single protection. For more details, refer to file E351759.

<b>UL</b>
The MAX12931 wide-body SOIC is certified under UL1577. For more details, refer to file E351759.
Rated up to 5000V <sub>RMS</sub> isolation voltage for single protection.
<b>cUL (Equivalent to CSA notice 5A)</b>
The MAX12931 wide-body SOIC is certified up to 5000V <sub>RMS</sub> for single protection. For more details, refer to file E351759.

<b>VDE</b>
The MAX12930–MAX12931 narrow-body SOIC are certified to DIN VDE V 0884-11: 2017-01
Basic Insulation, Maximum Transient Isolation Voltage 4200V <sub>PK</sub> , Maximum Repetitive Peak Isolation Voltage 630V <sub>PK</sub> .
For details, see file ref. 5015017-4880-0001/272147/TL7/SCT.

*These couplers are suitable for “safe electrical insulation” only within the safety ratings. Compliance with the safety ratings shall be ensured by means of suitable protective circuits.*

**Insulation Characteristics**

**Table 1. Narrow SOIC Insulation Characteristic**

PARAMETER	SYMBOL	CONDITIONS	VALUE	UNITS
Partial Discharge Test Voltage	V <sub>PR</sub>	Method B1 = V <sub>IORM</sub> × 1.875 (t = 1s, partial discharge < 5pC)	1182	V <sub>P</sub>
Maximum Repetitive Peak Isolation Voltage	V <sub>IORM</sub>	(Note 5)	630	V <sub>P</sub>
Maximum Working Isolation Voltage	V <sub>IOWM</sub>	Continuous RMS voltage (Note 5)	445	V <sub>RMS</sub>
Maximum Transient Isolation Voltage	V <sub>IOTM</sub>	t = 1s (Note 5)	4200	V <sub>P</sub>
Maximum Withstand Isolation Voltage	V <sub>ISO</sub>	f <sub>SW</sub> = 60Hz, duration = 60s (Note 5, 6)	3000	V <sub>RMS</sub>
Maximum Surge Isolation Voltage	V <sub>IOSM</sub>	Basic Insulation, 1.2/50µs pulse per IEC 61000-4-5 (Note 5, 8)	5000	V <sub>P</sub>
Insulation Resistance	R <sub>IO</sub>	V <sub>IO</sub> = 500V, T <sub>A</sub> = 25°C	> 10 <sup>12</sup>	Ω
		V <sub>IO</sub> = 500V, 100°C ≤ T <sub>A</sub> ≤ 125°C	> 10 <sup>11</sup>	
		V <sub>IO</sub> = 500V at T <sub>S</sub> = 150°C	> 10 <sup>9</sup>	
Barrier Capacitance Side A to Side B	C <sub>IO</sub>	f <sub>SW</sub> = 1MHz (Note 7)	2	pF
Minimum Creepage Distance	CPG	Narrow SOIC	4	mm
Minimum Clearance Distance	CLR	Narrow SOIC	4	mm
Internal Clearance		Distance through insulation	0.015	mm
Comparative Tracking Index	CTI	Material Group II (IEC 60112)	> 400	
Climate Category			40/125/21	
Pollution Degree (DIN VDE 0110, Table 1)			2	

**Table 2. Wide SOIC Insulation Characteristic**

PARAMETER	SYMBOL	CONDITIONS	VALUE	UNITS
Partial Discharge Test Voltage	V <sub>PR</sub>	Method B1 = V <sub>IORM</sub> × 1.875 (t = 1s, partial discharge < 5pC)	2250	V <sub>P</sub>
Maximum Repetitive Peak Isolation Voltage	V <sub>IORM</sub>	(Note 5)	1200	V <sub>P</sub>
Maximum Working Isolation Voltage	V <sub>IOWM</sub>	Continuous RMS voltage (Note 5)	848	V <sub>RMS</sub>
Maximum Transient Isolation Voltage	V <sub>IOTM</sub>	t = 1s (Note 5)	8400	V <sub>P</sub>
Maximum Withstand Isolation Voltage	V <sub>ISO</sub>	f <sub>SW</sub> = 60Hz, duration = 60s (Note 5, 6)	5000	V <sub>RMS</sub>
Maximum Surge Isolation Voltage	V <sub>IOSM</sub>	Basic Insulation, 1.2/50μs pulse per IEC 61000-4-5 (Note 5, 8)	10000	V <sub>P</sub>
Insulation Resistance	R <sub>IO</sub>	V <sub>IO</sub> = 500V, T <sub>A</sub> = 25°C	> 10 <sup>12</sup>	Ω
		V <sub>IO</sub> = 500V, 100°C ≤ T <sub>A</sub> ≤ 125°C	> 10 <sup>11</sup>	
		V <sub>IO</sub> = 500V at T <sub>S</sub> = 150°C	> 10 <sup>9</sup>	
Barrier Capacitance Side A to Side B	C <sub>IO</sub>	f <sub>SW</sub> = 1MHz (Note 7)	2	pF
Minimum Creepage Distance	CPG	Wide SOIC	8	mm
Minimum Clearance Distance	CLR	Wide SOIC	8	mm
Internal Clearance		Distance through insulation	0.015	mm
Comparative Tracking Index	CTI	Material Group I (IEC 60112)	>600	
Climate Category			40/125/21	
Pollution Degree (DIN VDE 0110, Table 1)			2	

**Note 5:** V<sub>ISO</sub>, V<sub>IOTM</sub>, V<sub>IOSM</sub>, V<sub>IOWM</sub>, and V<sub>IORM</sub> are defined by the IEC 60747-5-5 standard.

**Note 6:** Product is qualified at V<sub>ISO</sub> for 60s and 100% production tested at 120% of V<sub>ISO</sub> for 1s.

**Note 7:** Capacitance is measured with all pins on side A and side B tied together.

**Note 8:** Devices are immersed in oil during surge characterization.

## MAX12930/MAX12931

### Safety Limits

Damage to the IC can result in a low-resistance path to ground or to the supply and, without current limiting, the MAX12930–MAX12931 could dissipate excessive amounts of power. Excessive power dissipation can damage the die and result in damage to the isolation barrier, potentially causing downstream issues. [Table 3](#) shows the safety limits for the MAX12930–MAX12931.

The maximum safety temperature ( $T_S$ ) for the device is the 150°C maximum junction temperature specified in the [Absolute Maximum Ratings](#). The power dissipation ( $P_D$ ) and junction-to-ambient thermal impedance ( $\theta_{JA}$ ) determine the junction temperature. Thermal impedance values ( $\theta_{JA}$  and  $\theta_{JC}$ ) are available in the [Package Information](#) section of the datasheet and power dissipation calculations are discussed in the [Calculating Power Dissipation](#) section. Calculate the junction temperature ( $T_J$ ) as:

$$T_J = T_A + (P_D \times \theta_{JA})$$

## Two-Channel, Low-Power, 3kV<sub>RMS</sub> and 5kV<sub>RMS</sub> Digital Isolators

[Figure 2](#) and [Figure 3](#) show the thermal derating curves for the safety power limiting of the devices and [Figure 4](#) shows the thermal derating curve for the safety current limiting of the devices. Ensure that the junction temperature does not exceed 150°C.

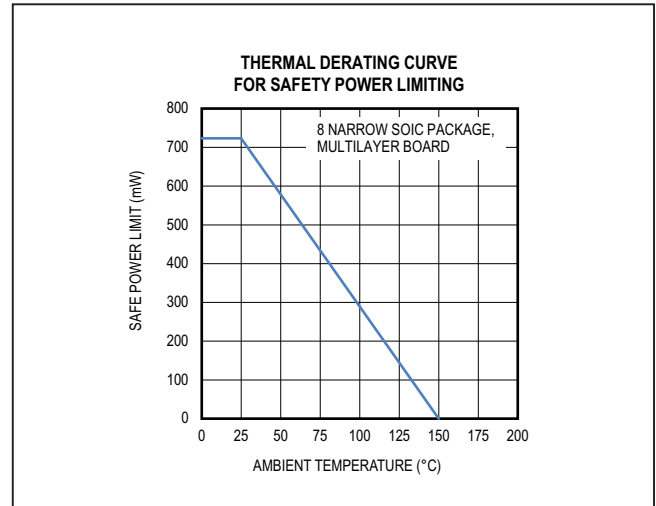

Figure 3. Thermal Derating Curve for Safety Power Limiting—8 Narrow SOIC

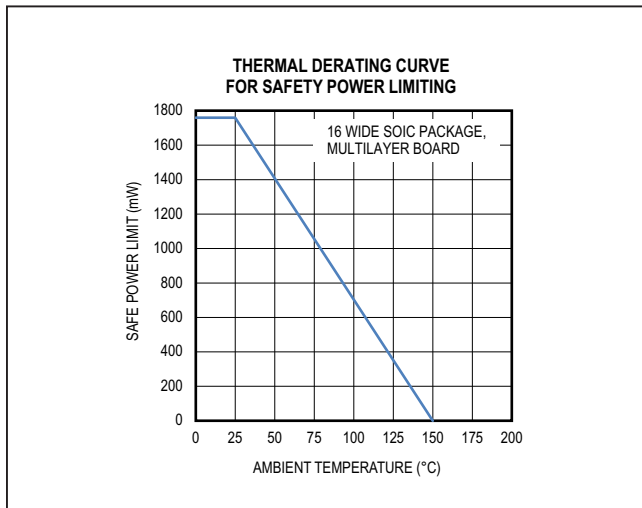

Figure 2. Thermal Derating Curve for Safety Power Limiting—16 Wide SOIC

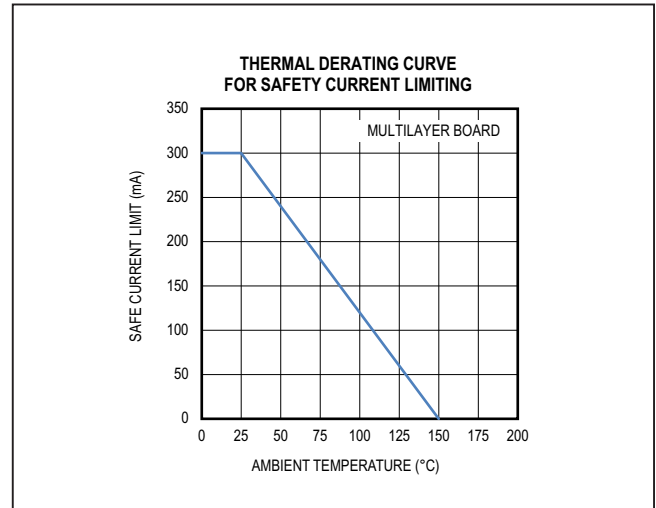

Figure 4. Thermal Derating Curve for Safety Current Limiting

Table 3. Safety Limiting Values for the MAX12930–MAX12931

PARAMETER	SYMBOL	TEST CONDITIONS	MAX	UNITS
Safety Current on Any Pin (No Damage to Isolation Barrier)	$I_S$	$T_J = 150^\circ\text{C}, T_A = 25^\circ\text{C}$	300	mA
Total Safety Power Dissipation	$P_S$	$T_J = 150^\circ\text{C}, T_A = 25^\circ\text{C}$	16 Wide SOIC	1760
			8 Narrow SOIC	723
Maximum Safety Temperature	$T_S$		150	$^\circ\text{C}$

Typical Operating Characteristics

( $V_{VDDA} - V_{GNDA} = +3.3\text{V}, V_{VDDB} - V_{GNDB} = +3.3\text{V}, V_{GNDA} = V_{GNDB}, T_A = +25^\circ\text{C}$ , unless otherwise noted.)

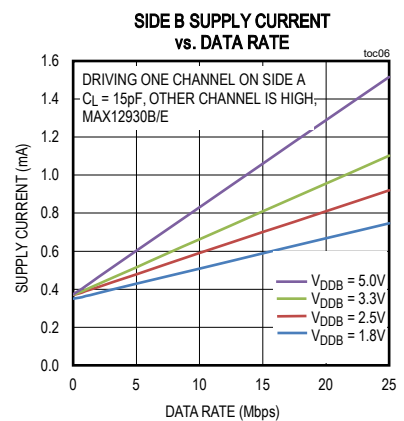
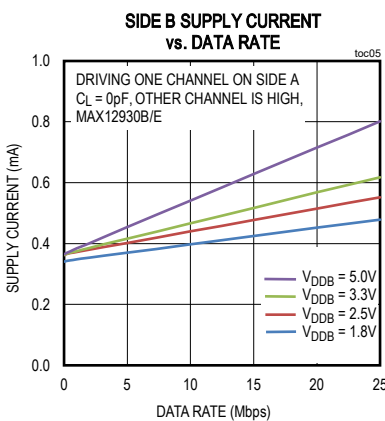
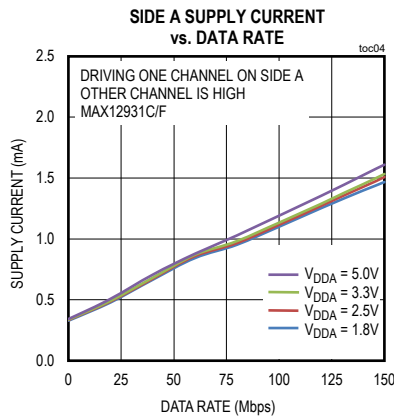
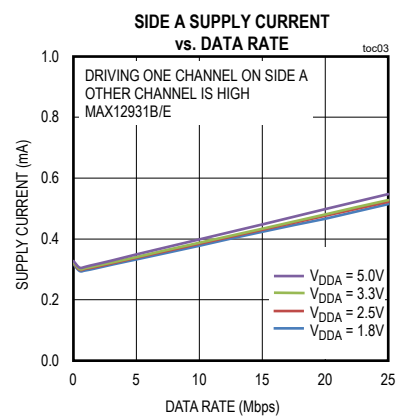
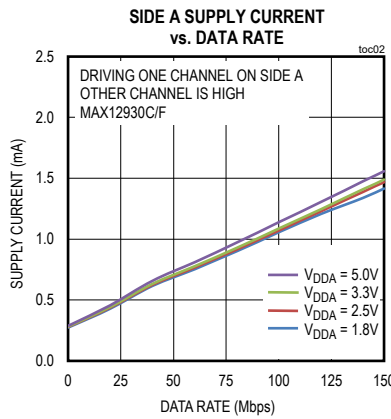
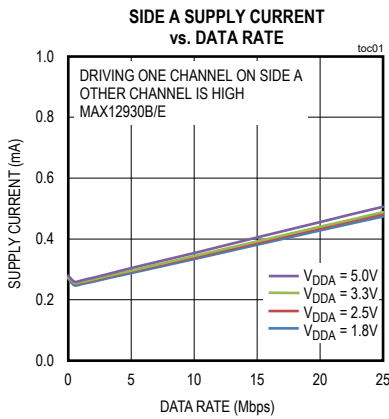

Typical Operating Characteristics (continued)

(V<sub>VDDA</sub> - V<sub>GNDA</sub> = +3.3V, V<sub>VDDB</sub> - V<sub>GNDB</sub> = +3.3V, V<sub>GNDA</sub> = V<sub>GNDB</sub>, T<sub>A</sub> = +25°C, unless otherwise noted.)

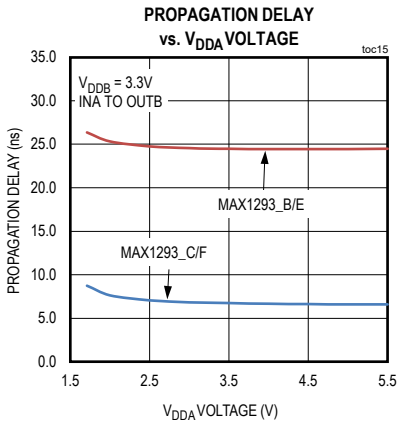
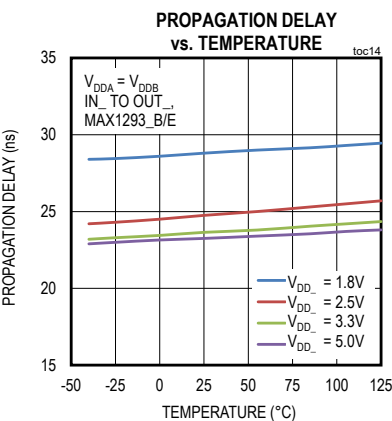
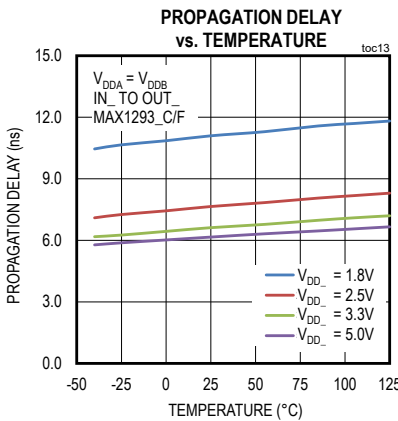
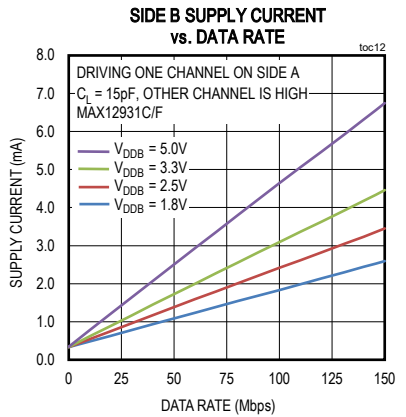
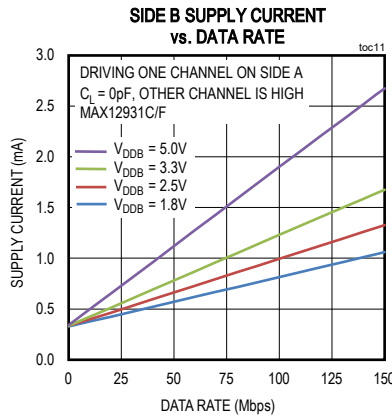
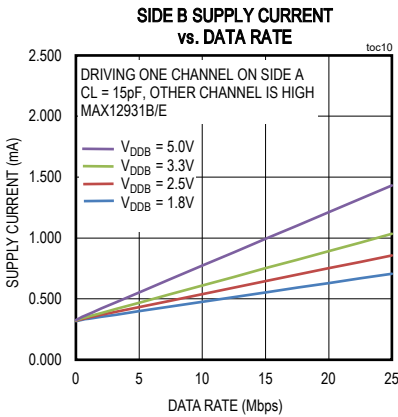
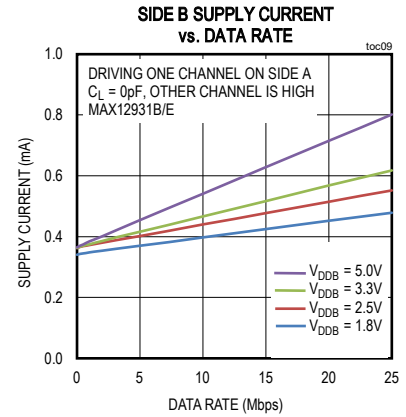
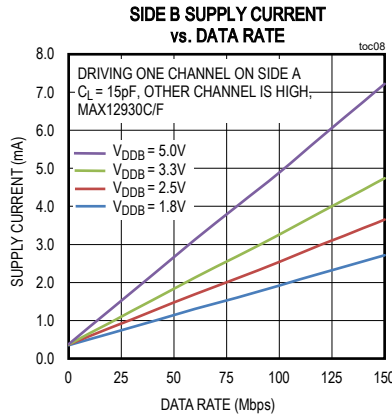
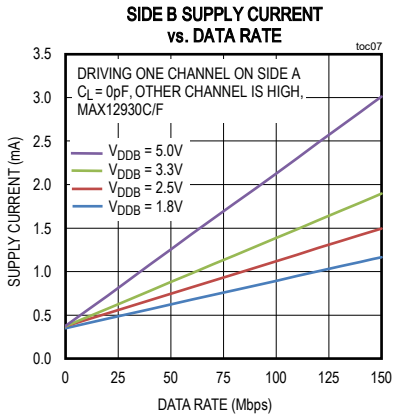

Typical Operating Characteristics (continued)

( $V_{VDDA} - V_{GNDA} = +3.3V$ ,  $V_{VDDB} - V_{GNDB} = +3.3V$ ,  $V_{GNDA} = V_{GNDB}$ ,  $T_A = +25^\circ C$ , unless otherwise noted.)

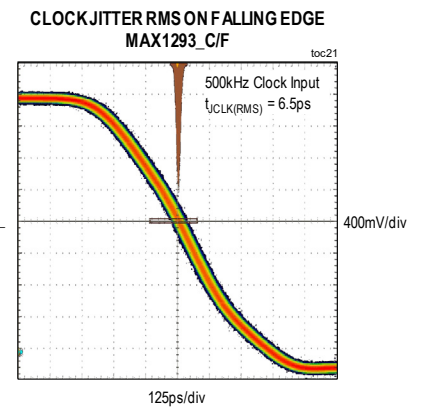
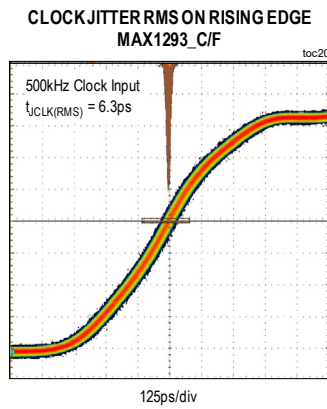
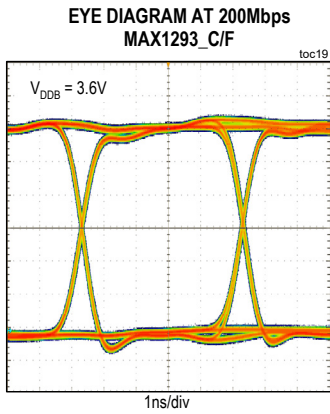
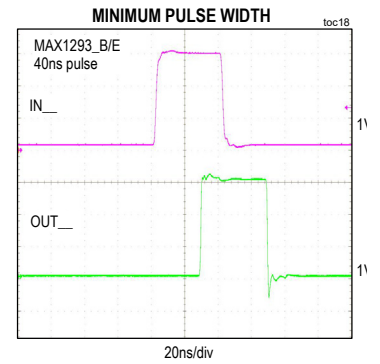
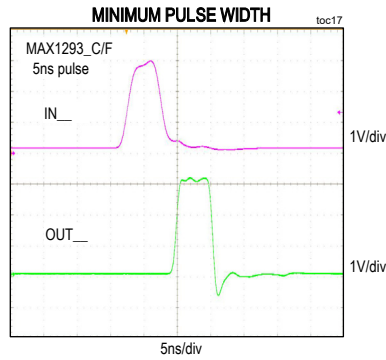
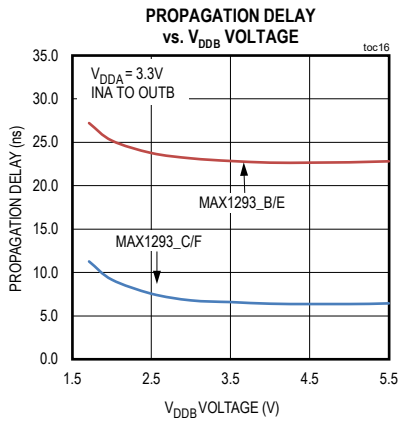

**Pin Configurations**

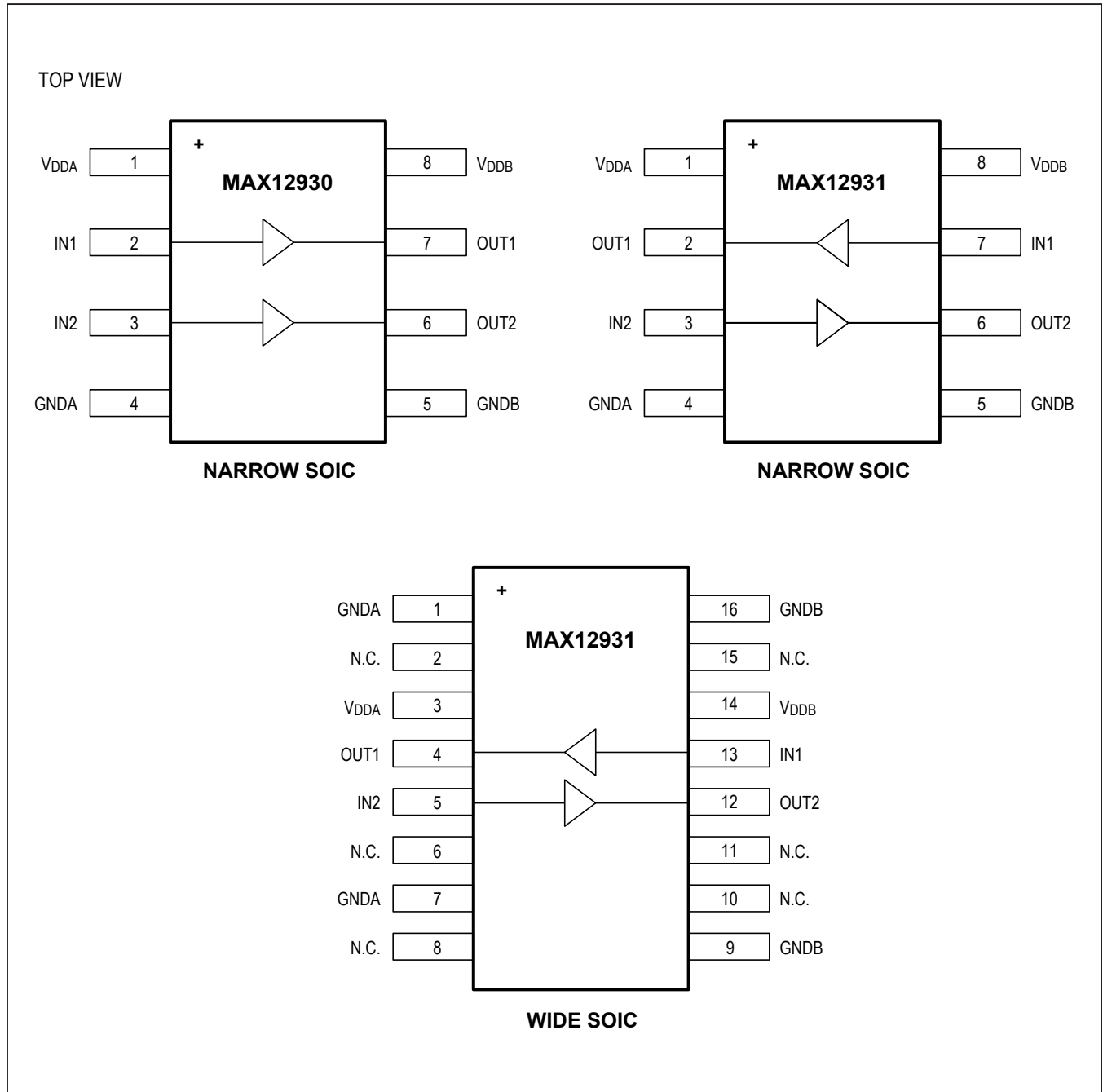



**Pin Description**

PIN			NAME	FUNCTION	REFERENCE
MAX12930 8-PIN SOIC	MAX12931 8-PIN SOIC	MAX12931 16-PIN SOIC			
1	1	3	V <sub>DDA</sub>	Power Supply for side A. Bypass V <sub>DDA</sub> with a 0.1µF ceramic capacitor to GNDA.	GNDA
2	—	—	IN1	Logic input for channel 1	GNDA
—	2	4	OUT1	Logic output of channel 1	GNDA
3	3	5	IN2	Logic input for channel 2	GNDA
4	4	1, 7	GNDA	Ground reference for side A	—
5	5	9, 16	GNDB	Ground reference for side B	—
6	6	12	OUT2	Logic output of channel 2	GNDB
7	—	—	OUT1	Logic output of channel 1	GNDB
—	7	13	IN1	Logic input for channel 1	GNDB
8	8	14	V <sub>DDB</sub>	Power Supply for side B. Bypass V <sub>DDB</sub> with a 0.1µF ceramic capacitor to GNDB.	GNDB
—	—	2, 6, 8, 10, 11, 15	N.C.	Not internally connected	—

**Typical Application Circuits**

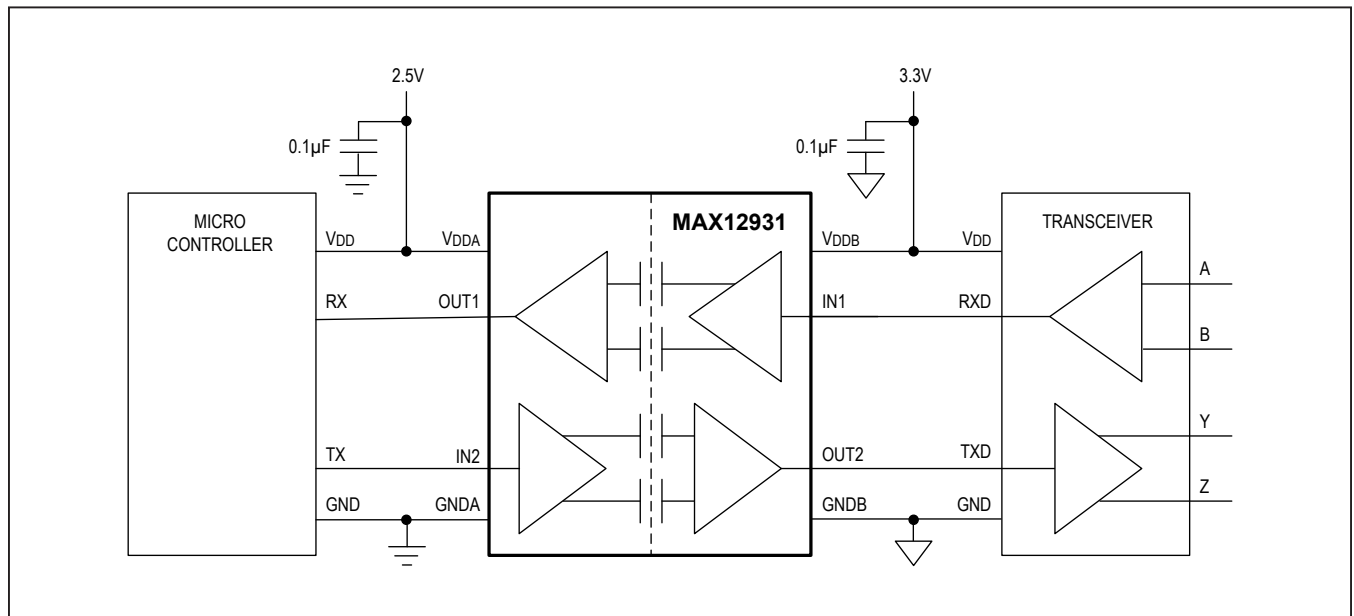

## Detailed Description

The MAX12930/MAX12931 are a family of 2-channel digital isolators. The MAX12930 transfers digital signals between circuits with different power domain in one direction, which is convenient for applications such as digital I/O. The MAX12931 transfers digital signals in opposite directions, which is necessary for isolated RS-485 or other UART applications.

Devices available in the 8-pin narrow body SOIC package are rated for up to 3kV<sub>RMS</sub> isolation voltage for 60 seconds and the device in the 16-pin wide body SOIC package is rated for up to 5kV<sub>RMS</sub>. This family of digital isolators offers low-power operation, high electromagnetic interference (EMI) immunity, and stable temperature performance through Maxim's proprietary process technology. The devices isolate different ground domains and block high-voltage/high-current transients from sensitive or human interface circuitry.

Devices are available with data rates from DC to 25Mbps (B/E versions) or 150Mbps (C/F versions). Each device can be ordered with default-high or default-low outputs. The default is the state the output assumes when the input is not powered, or if the input is open circuit.

The devices have two supply inputs (V<sub>DDA</sub> and V<sub>ddb</sub>) that independently set the logic levels on either side of device. V<sub>DDA</sub> and V<sub>ddb</sub> are referenced to GNDA and GNDB, respectively. The MAX12930/MAX12931 family also features a refresh circuit to ensure output accuracy when an input remains in the same state indefinitely.

## Digital Isolation

The device family provides galvanic isolation for digital signals that are transmitted between two ground domains. Up to 630V<sub>PEAK</sub> of continuous isolation is supported

in the narrow SOIC package and up to 1200V<sub>PEAK</sub> of continuous isolation is supported in the wide SOIC package. The devices withstand differences of up to 3kV<sub>RMS</sub> in the 8-pin narrow SOIC package or 5kV<sub>RMS</sub> in the 16-pin wide SOIC package for up to 60 seconds.

## Level-Shifting

The wide supply voltage range of both V<sub>DDA</sub> and V<sub>ddb</sub> allows the MAX12930/MAX12931 family to be used for level translation in addition to isolation. V<sub>DDA</sub> and V<sub>ddb</sub> can be independently set to any voltage from 1.71V to 5.5V. The supply voltage sets the logic level on the corresponding side of the isolator.

## Unidirectional Channels

Each channel of the MAX12930/MAX12931 is unidirectional; it only passes data in one direction, as indicated in the functional diagram. Each device features two unidirectional channels that operate independently with guaranteed data rates from DC up to 25Mbps (B/E versions), or DC to 150Mbps (C/F versions). The output driver of each channel is push-pull, eliminating the need for pullup resistors. The outputs are able to drive both TTL and CMOS logic inputs.

## Startup and Undervoltage-Lockout

The V<sub>DDA</sub> and V<sub>ddb</sub> supplies are both internally monitored for undervoltage conditions. Undervoltage events can occur during power-up, power-down, or during normal operation due to a sagging supply voltage. When an undervoltage condition is detected on either supply, all outputs go to their default states regardless of the state of the inputs (Table 4). Figure 5 through Figure 8 show the behavior of the outputs during power-up and power-down.

**Table 4. Output Behavior During Undervoltage Conditions**

V <sub>IN_</sub>	V <sub>DDA</sub>	V <sub>ddb</sub>	V <sub>OUTA_</sub>	V <sub>OUTB_</sub>
1	Powered	Powered	1	1
0	Powered	Powered	0	0
X	Undervoltage	Powered	Default	Default
X	Powered	Undervoltage	Default	Default

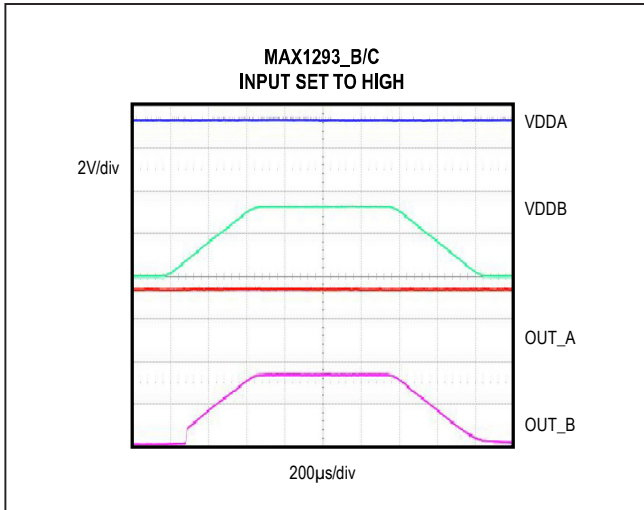

Figure 5. Undervoltage Lockout Behavior (MAX1293\_B/C High)

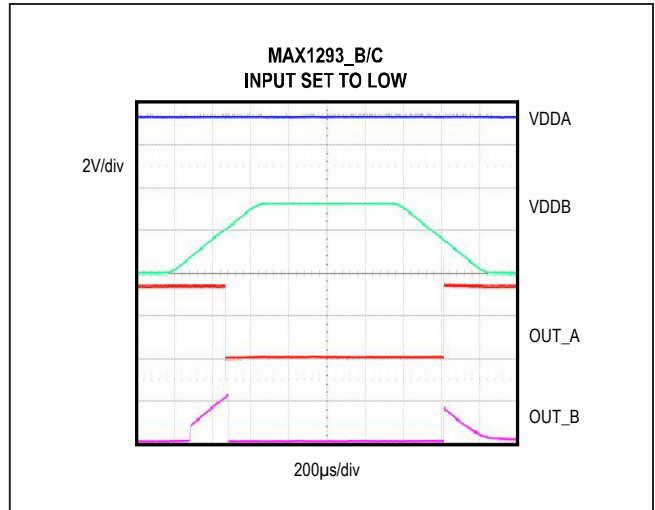

Figure 6. Undervoltage Lockout Behavior (MAX1293\_B/C Low)

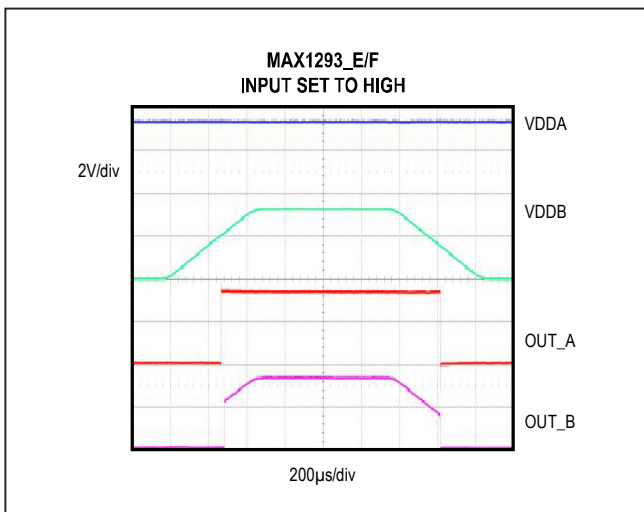

Figure 7. Undervoltage Lockout Behavior (MAX1293\_E/F High)

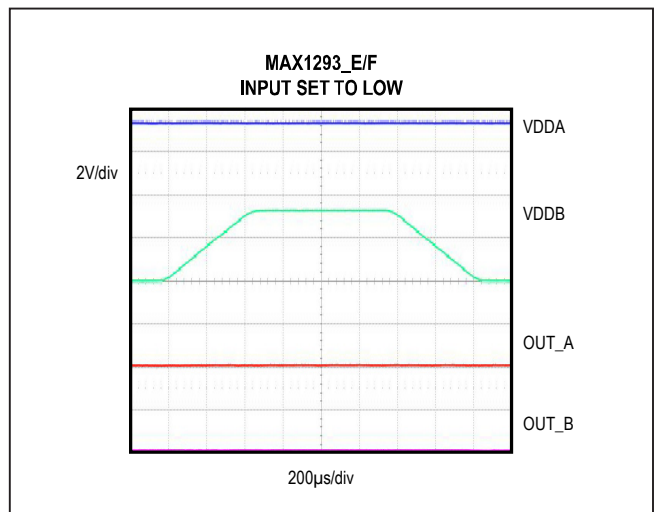

Figure 8. Undervoltage Lockout Behavior (MAX1293\_E/F Low)

## Application Information

### Power-Supply Sequencing

The MAX12930/MAX12931 do not require special power supply sequencing. The logic levels are set independently on either side by V<sub>DDA</sub> and V<sub>DDB</sub>. Each supply can be present over the entire specified range regardless of the level or presence of the other supply.

### Power-Supply Decoupling

To reduce ripple and the chance of introducing data errors, bypass V<sub>DDA</sub> and V<sub>DDB</sub> with 0.1µF low-ESR ceramic capacitors to GNDA and GNDB, respectively. Place the bypass capacitors as close to the power supply input pins as possible.

### Layout Considerations

The PCB designer should follow some critical recommendation in order to get the best performance from the design.

- Keep the input/output traces as short as possible. To keep signal paths low-inductance, avoid using vias.
- Have a solid ground plane underneath the high-speed signal layer.
- Keep the area underneath the MAX12930/MAX12931 free from ground and signal planes. Any galvanic or metallic connection between the field-side and logic-side defeats the isolation.

### Calculating Power Dissipation

The required current for a given supply (V<sub>DDA</sub> or V<sub>DDB</sub>) can be estimated by summing the current required for each channel. The supply current for a channel depends on whether the channel is an input or an output, the channel's data rate, and the capacitive or resistive load if it is an output. The typical current for an input or output at any data rate can be estimated from the graphs in [Figure 9](#) and [Figure 10](#). Please note that the data in [Figure 9](#) and [Figure 10](#) are extrapolated from the supply current measurements in a typical operating condition.

The total current for a single channel is the sum of the "no load" current (shown in [Figure 9](#) and [Figure 10](#)) which is a function of Voltage and Data Rate, and the "load current" which depends upon the type of load. Current into a capacitive load is a function of the load capacitance, the switching frequency, and the supply voltage.

$$I_{CL} = C_L \times f_{SW} \times V_{DD}$$

where,

I<sub>CL</sub> = Current required to drive the capacitive load.

C<sub>L</sub> = Load capacitance on the isolator's output pin.

f<sub>SW</sub> = Switching frequency (bits per second/2).

V<sub>DD</sub> = Supply voltage on the output side of the isolator.

Current into a resistive load depends on the load resistance, the supply voltage and the average duty cycle of the data waveform. The DC load current can be conservatively estimated by assuming the output is always high.

$$I_{RL} = V_{DD} \div R_L$$

where,

I<sub>RL</sub> = Current required to drive the resistive load.

V<sub>DD</sub> = Supply voltage on the output side of the isolator.

R<sub>L</sub> = Load resistance on the isolator's output pin.

Example (shown in [Figure 11](#)): A MAX12931F is operating with V<sub>DDA</sub> = 2.5V, V<sub>DDB</sub> = 3.3V, channel 1 operating at 100Mbps with a 15pF capacitive load, and channel 2 operating at 20Mbps with a 10pF capacitive load. Refer to [Table 5](#) and [Table 6](#) for V<sub>DDA</sub> and V<sub>DDB</sub> supply current calculation worksheets.

#### V<sub>DDA</sub> must supply:

Channel 1 is an output channel operating at 2.5V and 100Mbps, consuming 1.02mA, estimated from [Figure 10](#). Channel 2 is an input channel operating at 2.5V and 20Mbps, consuming 0.33mA, estimated from [Figure 9](#). I<sub>CL</sub> on channel 1 for 15pF capacitor at 2.5V and 100Mbps is 1.875mA.

**Total current for side A = 1.02 + 0.33 + 1.875 = 3.225mA, typical**

#### V<sub>DDB</sub> must supply:

Channel 1 is an input channel operating at 3.3V and 100Mbps, consuming 1.13mA, estimated from [Figure 9](#). Channel 2 is an output channel operating at 3.3V and 20Mbps, consuming 0.42mA, estimated from [Figure 10](#). I<sub>CL</sub> on channel 2 for 10pF capacitor at 3.3V and 20Mbps is 0.33mA.

**Total current for side B = 1.13 + 0.42 + 0.33 = 1.88mA, typical**

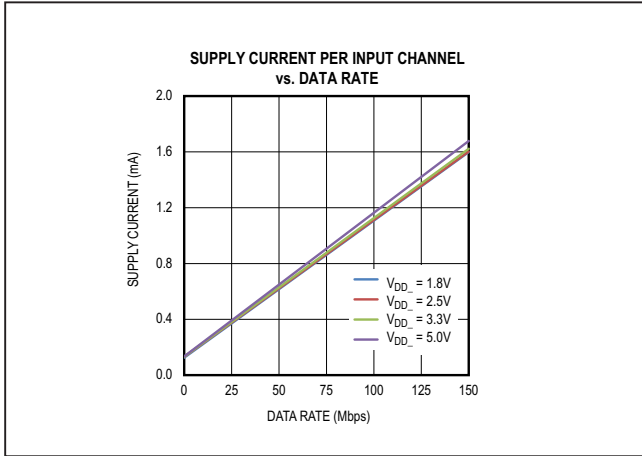

Figure 9. Supply Current per Input Channel Versus Data Rate

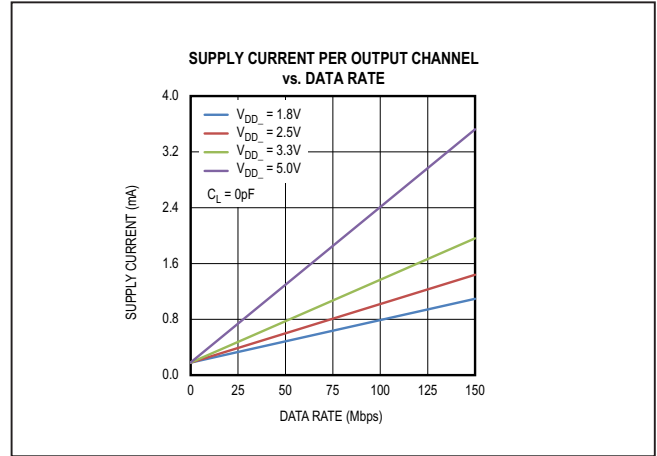

Figure 10. Supply Current per Output Channel Versus Data Rate

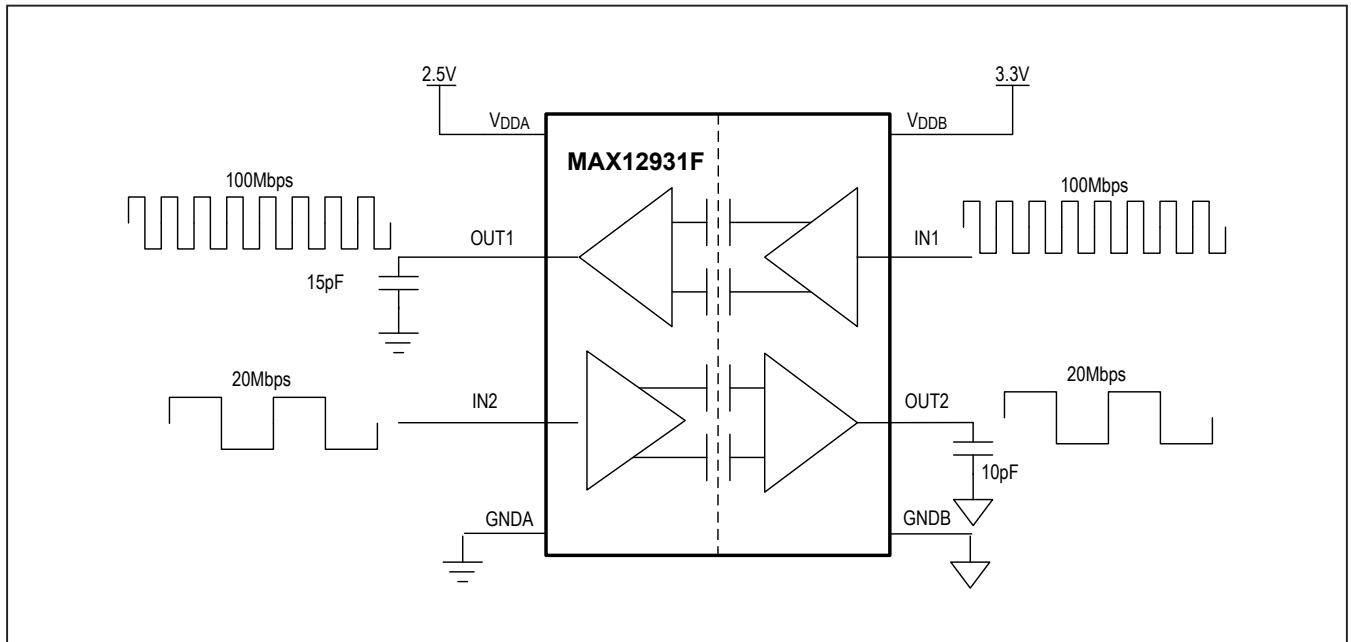

Figure 11. Example Circuit for Supply Current Calculation

**Table 5. Side A Supply Current Calculation Worksheet**

SIDE A		V <sub>DDA</sub> = 2.5V				
CHANNEL	IN/OUT	FREQUENCY (Mbps)	LOAD TYPE	LOAD	“NO LOAD” CURRENT (mA)	LOAD CURRENT (mA)
1	OUT	100	Capacitive	15pF	1.02	2.5V x 50MHz x 15pF = 1.875mA
2	IN	20			0.33	
Total:					3.225mA	

**Table 6. Side B Supply Current Calculation Worksheet**

SIDE B		V <sub>DDB</sub> = 3.3V				
CHANNEL	IN/OUT	FREQUENCY (Mbps)	LOAD TYPE	LOAD	“NO LOAD” CURRENT (mA)	LOAD CURRENT (mA)
1	IN	100			1.13	
2	OUT	20	Capacitive	10pF	0.42	3.3V x 10MHz x 10pF = 0.33mA
Total:					1.88mA	

# MAX12930/MAX12931

Two-Channel, Low-Power,  
3kV<sub>RMS</sub> and 5kV<sub>RMS</sub> Digital Isolators

## Product Selector Guide

The diagram shows the pin configurations for the MAX12930 and MAX12931. The pins are labeled 1, F, A, S, A, +. The configurations are as follows:

- CHANNEL CONFIGURATION:** 0: 2/0, 1: 1/1
- MAXIMUM DATA RATE DEFAULT OUTPUT (SEE TABLE):** F
- TEMP RANGE: -40°C TO +125°C:** A
- PACKAGE:** S: N SOIC, W: W SOIC
- PINS:** A: 8, E: 16
- LEAD-FREE/ROHS COMPLIANT:** +

DEVICE CONFIGURATION	MAX DATA RATE	
	25 Mbps	150 Mbps
DEFAULT-HIGH OUTPUT	B	C
DEFAULT-LOW OUTPUT	E	F

## Ordering Information

PART	CHANNEL CONFIGURATION	DATA RATE (Mbps)	DEFAULT OUTPUT	ISOLATION VOLTAGE (kV <sub>RMS</sub> )	TEMP RANGE	PIN-PACKAGE
<b>MAX12930</b> BASA+	2/0	25	High	3	-40°C to 125°C	8 Narrow SOIC
MAX12930CASA+	2/0	150	High	3	-40°C to 125°C	8 Narrow SOIC
MAX12930EASA+	2/0	25	Low	3	-40°C to 125°C	8 Narrow SOIC
MAX12930FASA+	2/0	150	Low	3	-40°C to 125°C	8 Narrow SOIC
<b>MAX12931</b> BASA+	1/1	25	High	3	-40°C to 125°C	8 Narrow SOIC
MAX12931CASA+	1/1	150	High	3	-40°C to 125°C	8 Narrow SOIC
MAX12931EASA+	1/1	25	Low	3	-40°C to 125°C	8 Narrow SOIC
MAX12931FASA+	1/1	150	Low	3	-40°C to 125°C	8 Narrow SOIC
MAX12931BAWE+	1/1	25	High	5	-40°C to 125°C	16 Wide SOIC

+Denotes a lead(Pb)-free/RoHS-compliant package.

## Chip Information

PROCESS: BICMOS

## Revision History

REVISION NUMBER	REVISION DATE	DESCRIPTION	PAGES CHANGED
0	6/16	Initial release	—
1	3/17	Added <i>Safety Regulatory Approvals</i> section, updated <i>Absolute Maximum Rating</i> , <i>Package Thermal Characteristics</i> , and <i>Electrical Characteristics</i> sections, and removed future product status from MAX12930FASA+ and MAX12931BASA+	1, 2, 5, 7–13, 15–19
2	8/17	Removed future asterisk from MAX12931FASA+ in <i>Ordering Information</i> table	21
3	10/17	Removed future asterisk from MAX12930BASA+ in <i>Ordering Information</i> table	21
4	11/18	Removed future asterisk from MAX12930EASA+ and MAX12931EASA+ in <i>Ordering Information</i> table	21
5	3/19	Added "VDE 0884-10 Basic" under <i>Safety Regulatory Approvals</i> , and updated the table. Updated Table 1 and Table 2	1, 8, 9, 10
6	8/19	Updated the <i>General Description</i> , Table 1, and Table 2; corrected subscripts in the <i>Benefits and Features</i> section	1, 9, 10
7	10/19	Removed future product asterisk from MAX12930CASA+	21
8	11/19	Removed future product asterisk from MAX12931CASA+	21
9	11/20	Updated <i>General Description</i> , <i>Safety Regulatory Approvals</i> , <i>Absolute Maximum Ratings</i> , <i>Package Information</i> , <i>Dynamic Characteristics MAX1293_B/E</i> , <i>Dynamic Characteristics MAX1293_C/F</i> , <i>Safety Regulatory Approvals</i> , <i>Insulation Characteristics</i> , <i>Typical Operating Circuit</i> , and <i>Layout Considerations</i> sections; added <i>Safety Limits</i> and <i>Product Selector Guide</i> sections; added new Figure 2–4 and renumbered subsequent figures; replaced Figure 9–10; updated Tables 1 and 2; added Table 3 and renumbered subsequent tables	1–2, 5–11, 15–21
10	8/21	Updated <i>General Description</i> , <i>Benefits and Features</i> , <i>Dynamic Characteristics MAX1293_B/E</i> , <i>Dynamic Characteristics MAX1293_C/F</i> , <i>Safety Regulatory Approvals</i> , replaced TOC 13, 14, 19, and replaced Figure 5–8,	1, 5–7, 9, 14, 15, 19



Information furnished by Analog Devices is believed to be accurate and reliable. However, no responsibility is assumed by Analog Devices for its use, nor for any infringements of patents or other rights of third parties that may result from its use. Specifications subject to change without notice. No license is granted by implication or otherwise under any patent or patent rights of Analog Devices. Trademarks and registered trademarks are the property of their respective owners.



# Mouser Electronics

Authorized Distributor

Click to View Pricing, Inventory, Delivery & Lifecycle Information:

## [Analog Devices Inc.:](#)

[MAX12931BWEVKIT#](#) [MAX12931BAWE+T](#)

Other:

[MAX12931BAWE+](#) [MAX12931BASA+T](#) [MAX12931BASA+](#) [MAX12931FASA+](#) [MAX12931EASA+T](#)  
[MAX12931EASA+](#) [MAX12931FASA+T](#) [MAX12931CASA+T](#) [MAX12931CASA+](#)