

PART NUMBER	SML-LXT0805SYW-TR	REV.	G
DATE	E.C.N. NUMBER AND REVISION COMMENTS	REV.	
12.08.99	E.C.N. #10567.	A	
01.08.01	E.C.N. #10695.	B	
02.25.02	E.C.N. #10814.	C	
03.22.04	E.C.N. #10967.	D	
08.12.05	E.C.N. #11248.	E	
09.30.09	E.C.N. #11508.	F	
12.17.19	ECN-Lumex201900133	G	

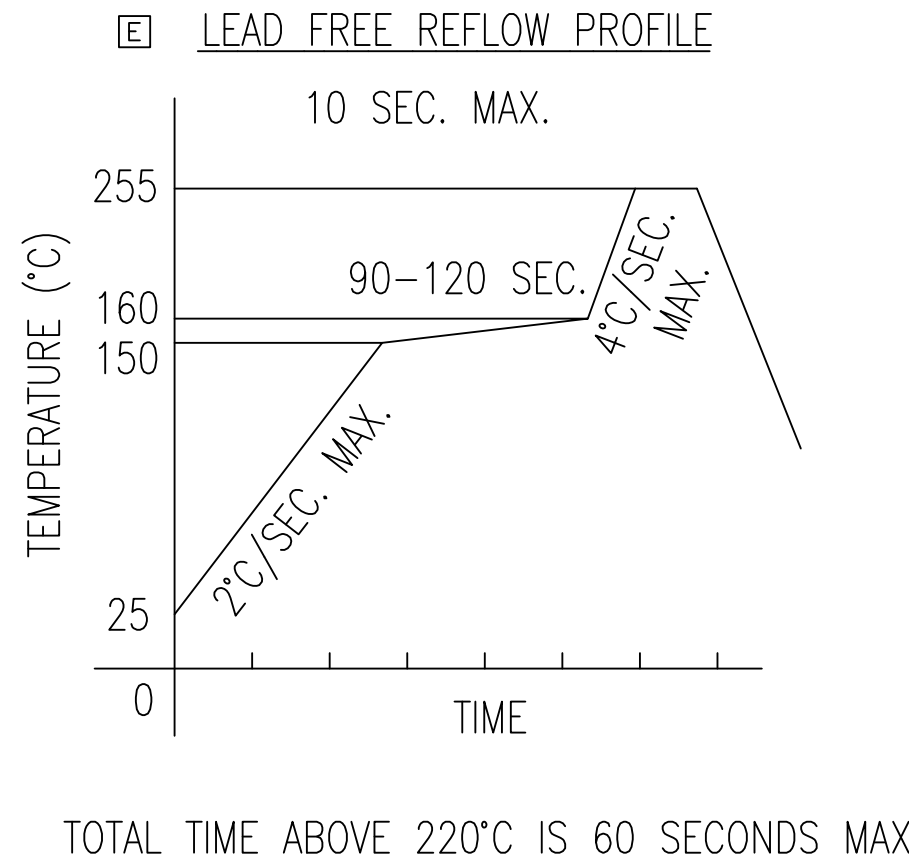
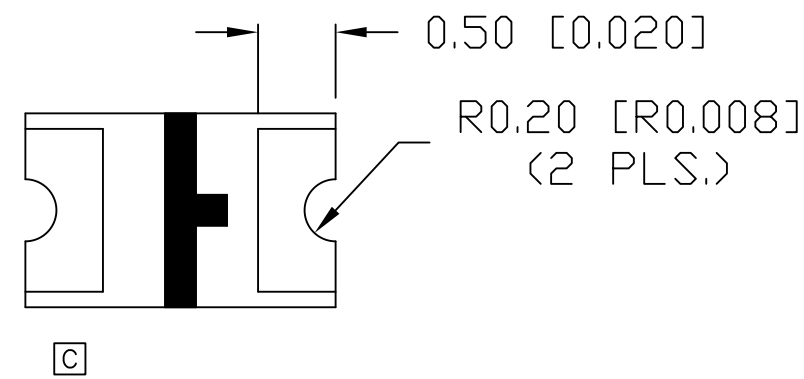
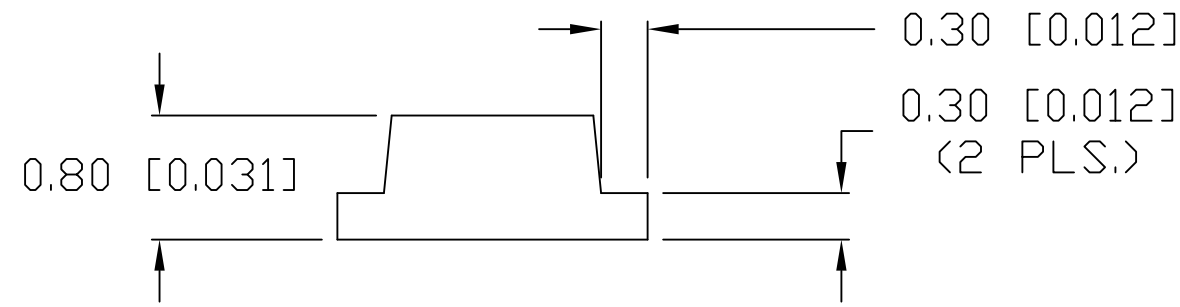
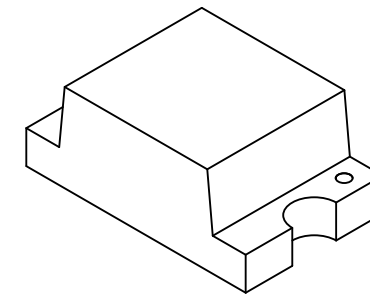
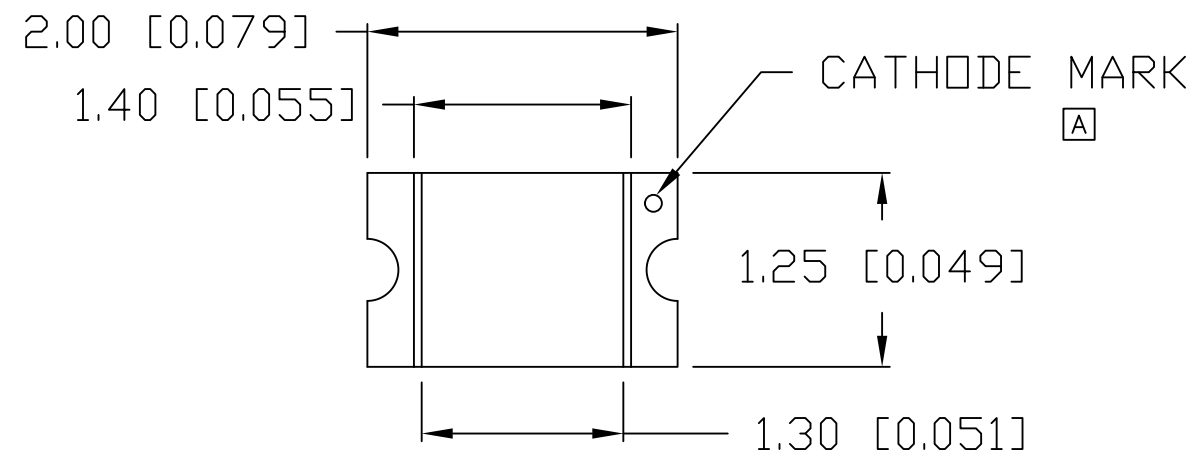

ELECTRO-OPTICAL CHARACTERISTICS $T_A=25^\circ\text{C}$ $I_f=20\text{mA}$

PARAMETER	MIN	TYP	MAX	UNITS	TEST COND
PEAK WAVELENGTH		590		nm	
FORWARD VOLTAGE		2.1	2.5	V_f	
REVERSE VOLTAGE	5.0			V_r	$I_r=100\mu\text{A}$
AXIAL INTENSITY	25	60		mcd	$I_f=20\text{mA}$
VIEWING ANGLE		140		2x theta	
EMITTED COLOR:	YELLOW				
EPOXY LENS FINISH:	MILKY WHITE DIFFUSED				

LIMITS OF SAFE OPERATION AT 25°C

PARAMETER	MAX	UNITS
PEAK FORWARD CURRENT*	100	mA
STEADY CURRENT	30	mA
POWER DISSIPATION	100	mW
DERATE FROM 25°C	-1.2	mW/°C
OPERATING TEMP.	-25 TO +80	°C
STORAGE TEMP.	-30 TO +85	°C

* $t < 10\mu\text{s}$

NOTES:

- 4K PER REEL
- CATHODE IS ORIENTED TOWARDS THE TAPE SPROCKET HOLE.

CAUTION: MOISTURE SENSITIVE DEVICE
PER JEDEC LEVEL 2a STANDARDS

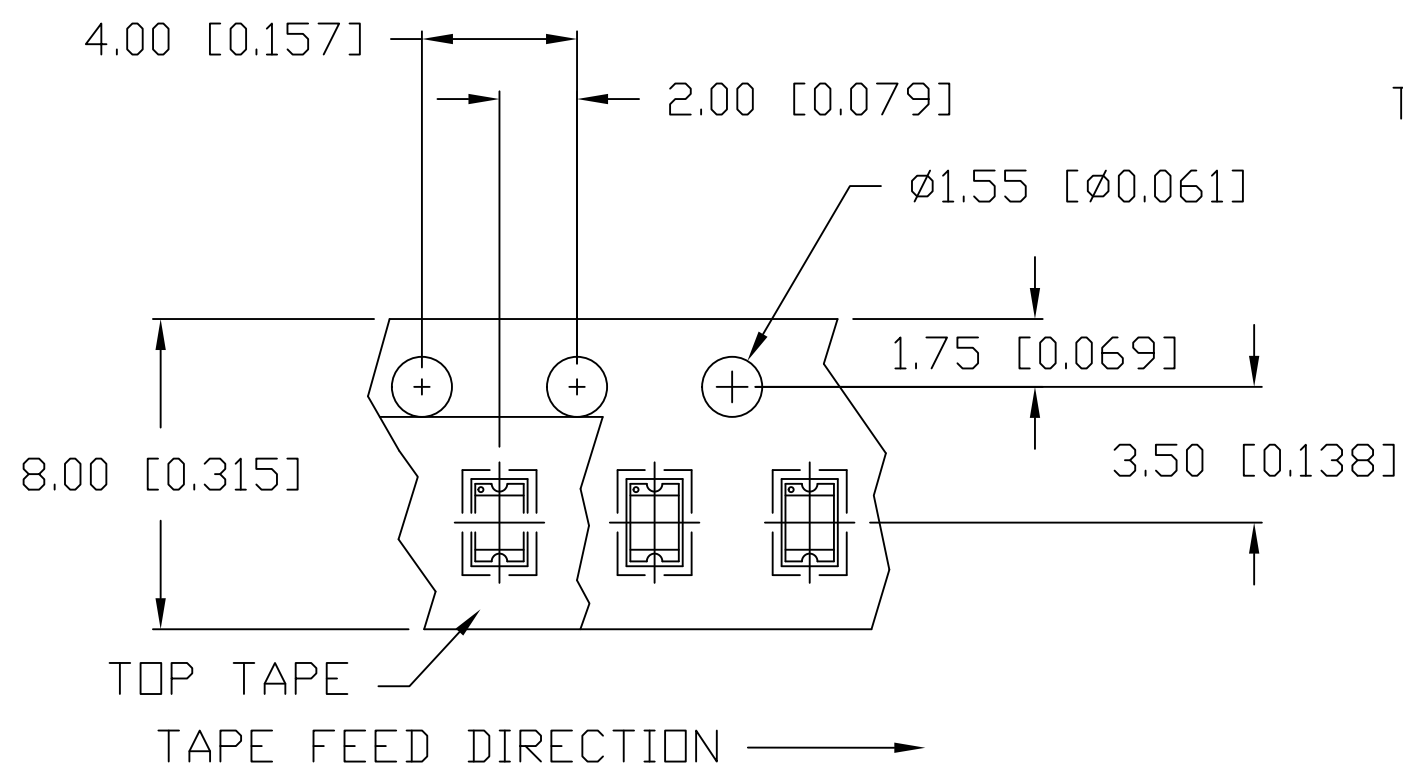

RECOMMENDED SOLDER PAD LAYOUT

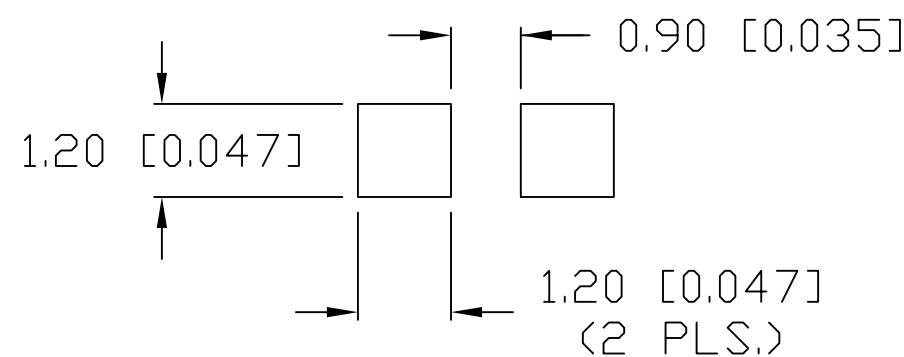

*UNLESS OTHERWISE SPECIFIED TOLERANCES PER DECIMAL PRECISION ARE: X=±1 (±0.039), X.X=±0.5 (±0.020), X.XX=±0.25 (±0.010), X.XXX=±0.127 (±0.005). LEAD SIZE=±0.05 (±0.002), LEAD LENGTH=±0.75 (±0.030). MIN= +DECIMAL PRECISION -0.00 MAX.= +0.00 -DECIMAL PRECISION



425 N. GARY AVE.
CAROL STREAM, IL 60188
PHONE: 800-278-5666
FAX: 630-315-2150
WEB: WWW.LUMEX.COM

2.0mm x 1.25mm THIN PCB SURFACE MOUNT LED, 590nm YELLOW, MILKY WHITE DIFFUSED LENS, TAPE AND REEL.

THE SPECIFICATIONS MAY CHANGE AT ANY TIME WITHOUT NOTICE.

CONFIDENTIAL INFORMATION
THE INFORMATION CONTAINED IN THIS DOCUMENT IS THE PROPERTY OF LUMEX INC. EXCEPT AS SPECIFICALLY AUTHORIZED IN WRITING BY LUMEX INC., THE HOLDER OF THIS DOCUMENT SHALL KEEP ALL INFORMATION CONTAINED HEREIN CONFIDENTIAL AND SHALL PROTECT SAME IN WHOLE OR IN PART FROM DISCLOSURE AND DISSEMINATION TO ALL THIRD PARTIES.

DATE:	12.17.19	DRAWN BY:	C.S.
PAGE:	1 OF 1	CHKD BY:	E.C.
SCALE:	NTS	APRVD BY:	G.Y.
UNIT:	mm [INCH]		(R6)

Mouser Electronics

Authorized Distributor

Click to View Pricing, Inventory, Delivery & Lifecycle Information:

Lumex:

[SML-LXT0805SYW-TR](#)