

868 MHz Ceramic Chip Antenna

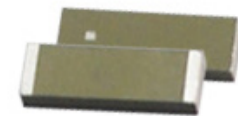

ACAG1204-868-T



12.0 x 4.0 x 1.6mm
RoHS/RoHS II Compliant
MSL = 1

FEATURES

- Uses Low Temperature Co-Fired Ceramic (LTCC) Technology
- Gain of 2.63 dBi
- Omni-directional
- VSWR of ≤ 2.0

APPLICATIONS

- ISM applications
- LORA
- Sigfox
- RFID

ELECTRICAL SPECIFICATIONS

Item	Specification
Frequency	868MHz
Bandwidth	20MHz typ
VSWR	≤ 2.0
Impedance	50 Ω
Gain	2.63dBi
Azimuth	Omni-directional
Polarization	Linear
Operating Temperature range	-40°C ~+ 85°C

DIMENSIONS

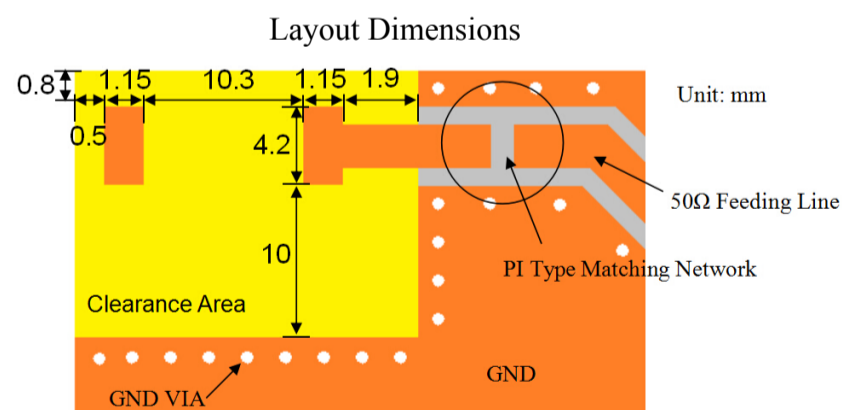
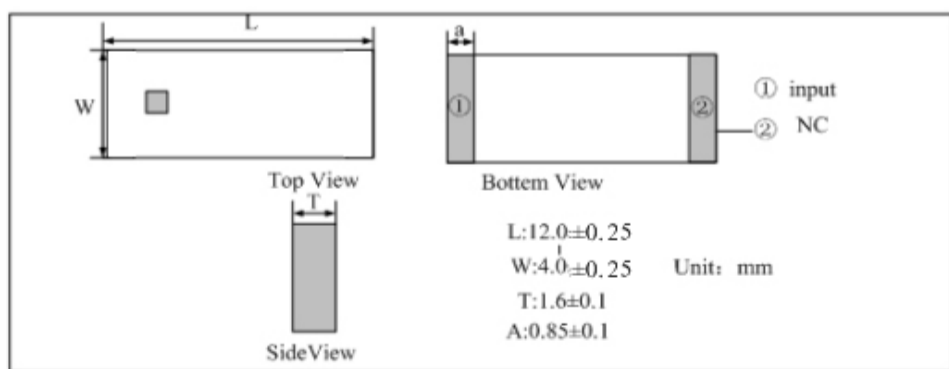

Unit: mm

868 MHz Ceramic Chip Antenna

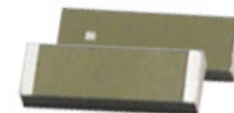

ACAG1204-868-T



12.0 x 4.0 x 1.6mm
RoHS/RoHS II Compliant
MSL = 1

EVALUATION BOARD AND MATCHING CIRCUITS

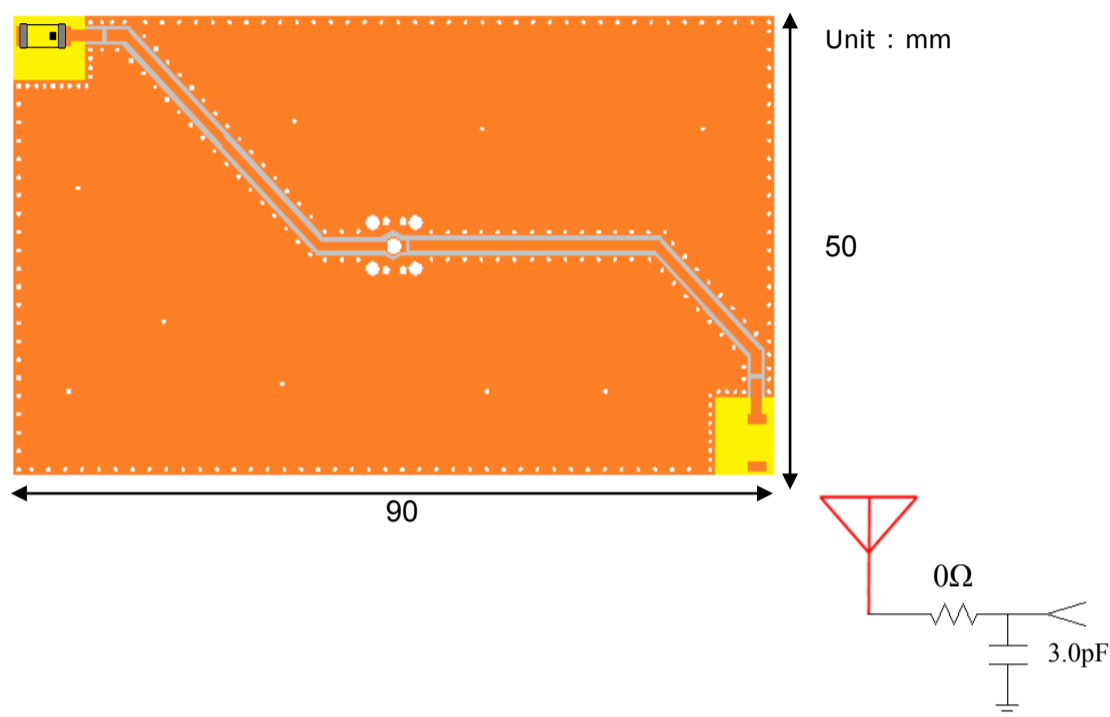

ANTENNA RESPONSE – SMITH CHART AND RETURN LOSS S11

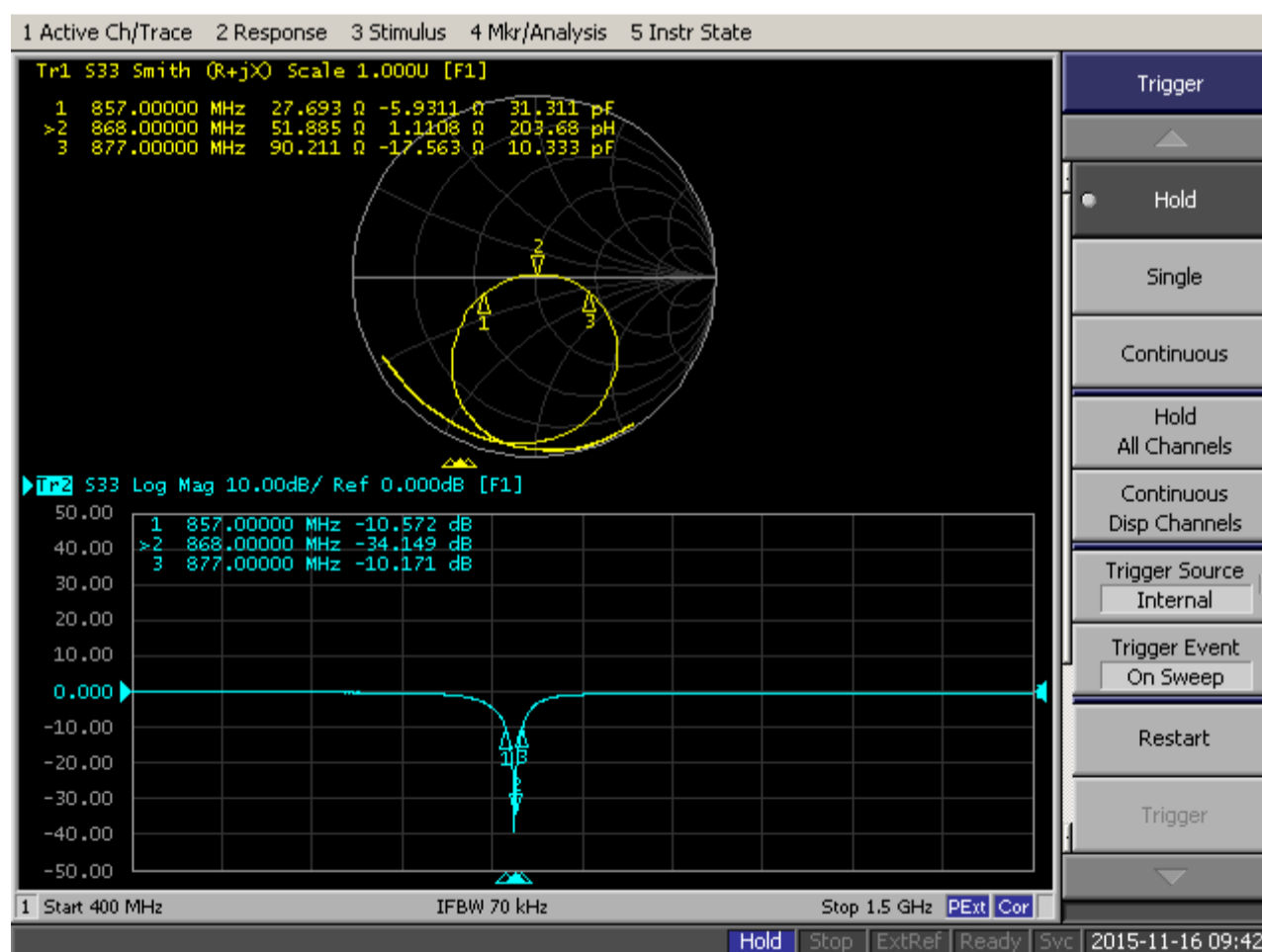

868 MHz Ceramic Chip Antenna

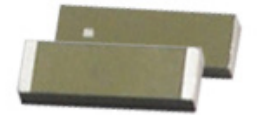

ACAG1204-868-T



12.0 x 4.0 x 1.6mm
RoHS/RoHS II Compliant
MSL = 1

RADIATION PATTERNS

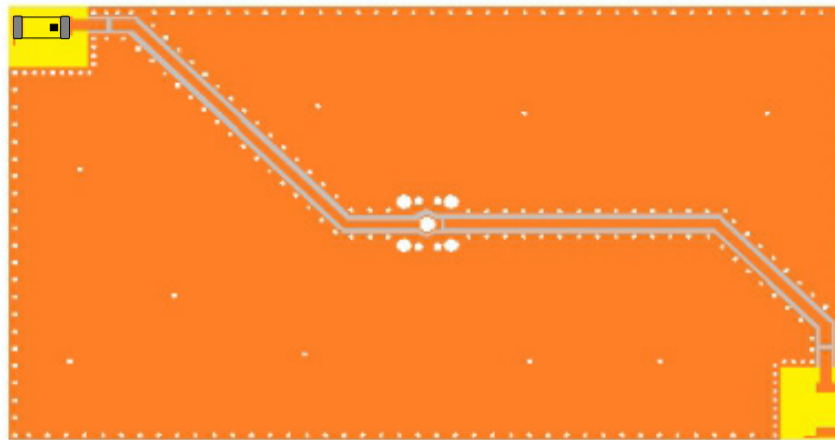
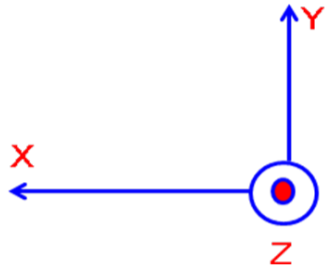

X-Z Plane

Y-Z Plane

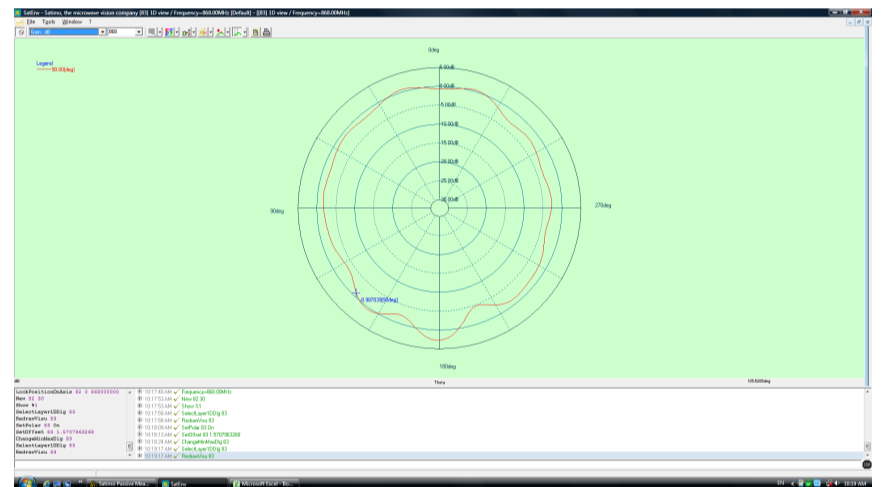
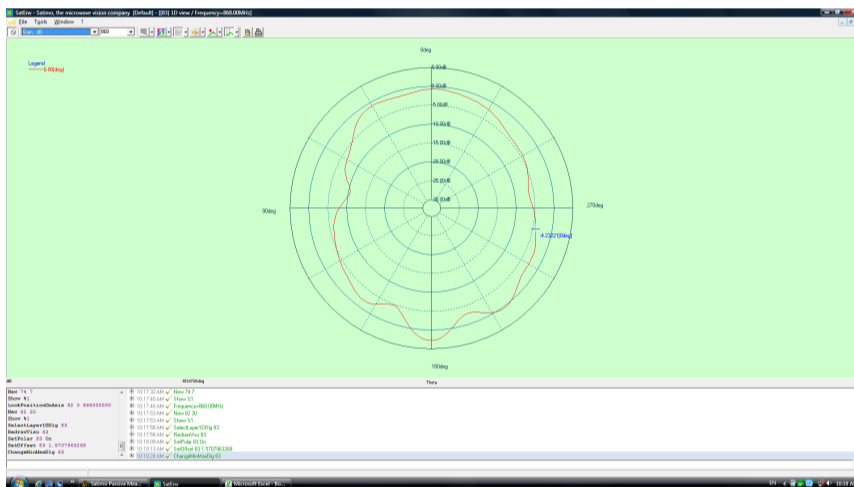

X-Y Plane

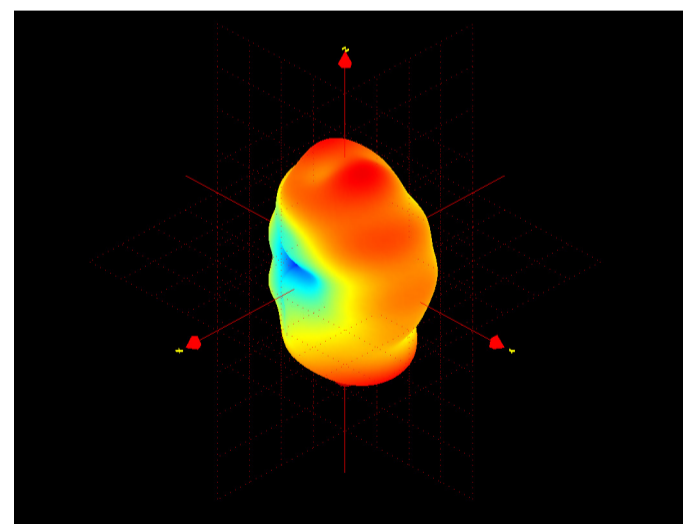
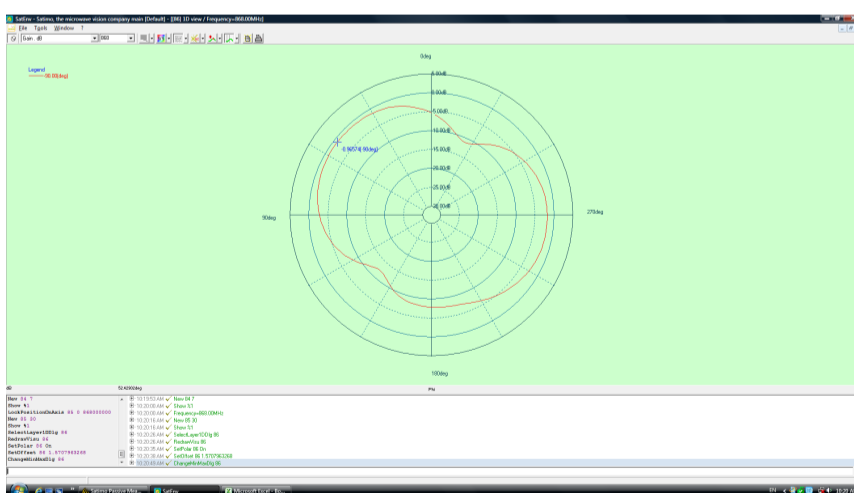

Frequency (MHz)	858	868	878
Avg. Gain (dBi)	-2.68	-2.05	-2.72
Peak Gain (dBi)	2.35	2.63	2.26
Efficiency (%)	48	52	50

868 MHz Ceramic Chip Antenna



ACAG1204-868-T



12.0 x 4.0 x 1.6mm
RoHS/RoHS II Compliant
MSL = 1

REFLOW PROFILE

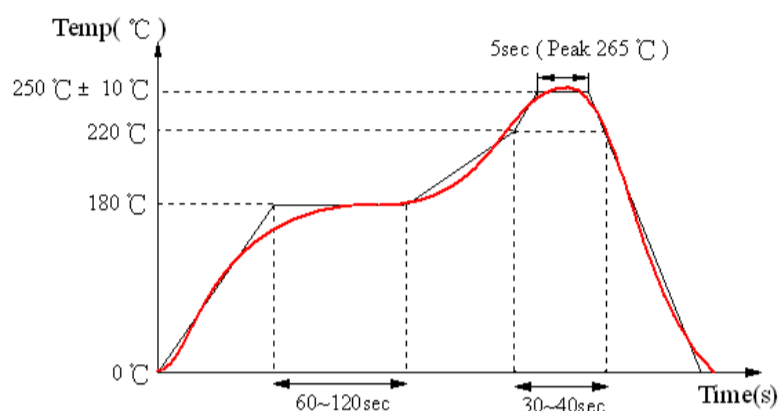

PACKAGING

Package Type	Quantity/Size
Inner Box	3000 pcs/reel
Carton	15000 pcs/carton
Size of the carton	345 x 250 x 360 mm

Tape Dimensions (mm)

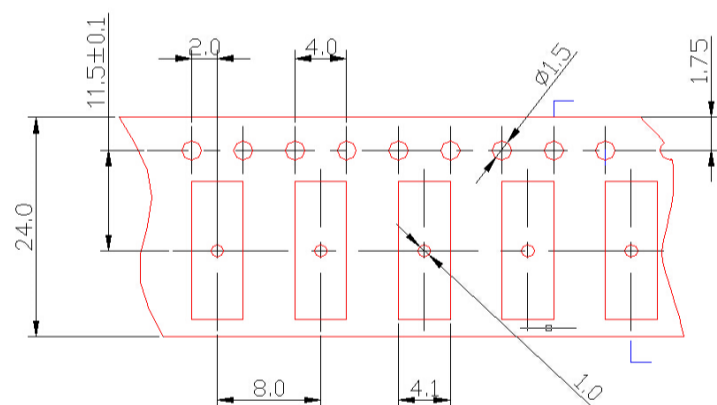

Reel Dimensions (mm)

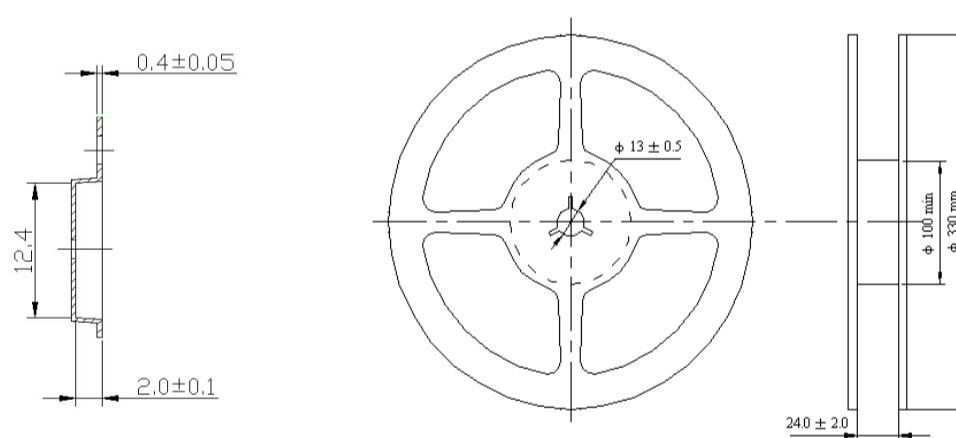

Unit: mm

CAUTIONS

1. Static voltage

Static voltage between signal & ground may cause deterioration & destruction of the component. Please avoid static voltage.

2. Ultrasonic cleaning

Ultrasonic vibration may cause deterioration & destruction of the component. Please avoid ultrasonic cleaning.

3. Soldering

Only leads of the component may be soldered. Please avoid soldering to any other part of the component, such as on the patterns as this will change the performance of the antenna.

Mouser Electronics

Authorized Distributor

Click to View Pricing, Inventory, Delivery & Lifecycle Information:

[ABRACON:](#)

[ACAG1204-868-T](#)