

THIS DRAWING IS UNPUBLISHED. RELEASED FOR PUBLICATION 20
 © COPYRIGHT 20 BY - ALL RIGHTS RESERVED.

REVISIONS				
P	LTR	DESCRIPTION	DATE	APVD
A3		ADD NEW PART 1-1 AND 1-2	28SEP2014	AY SZ

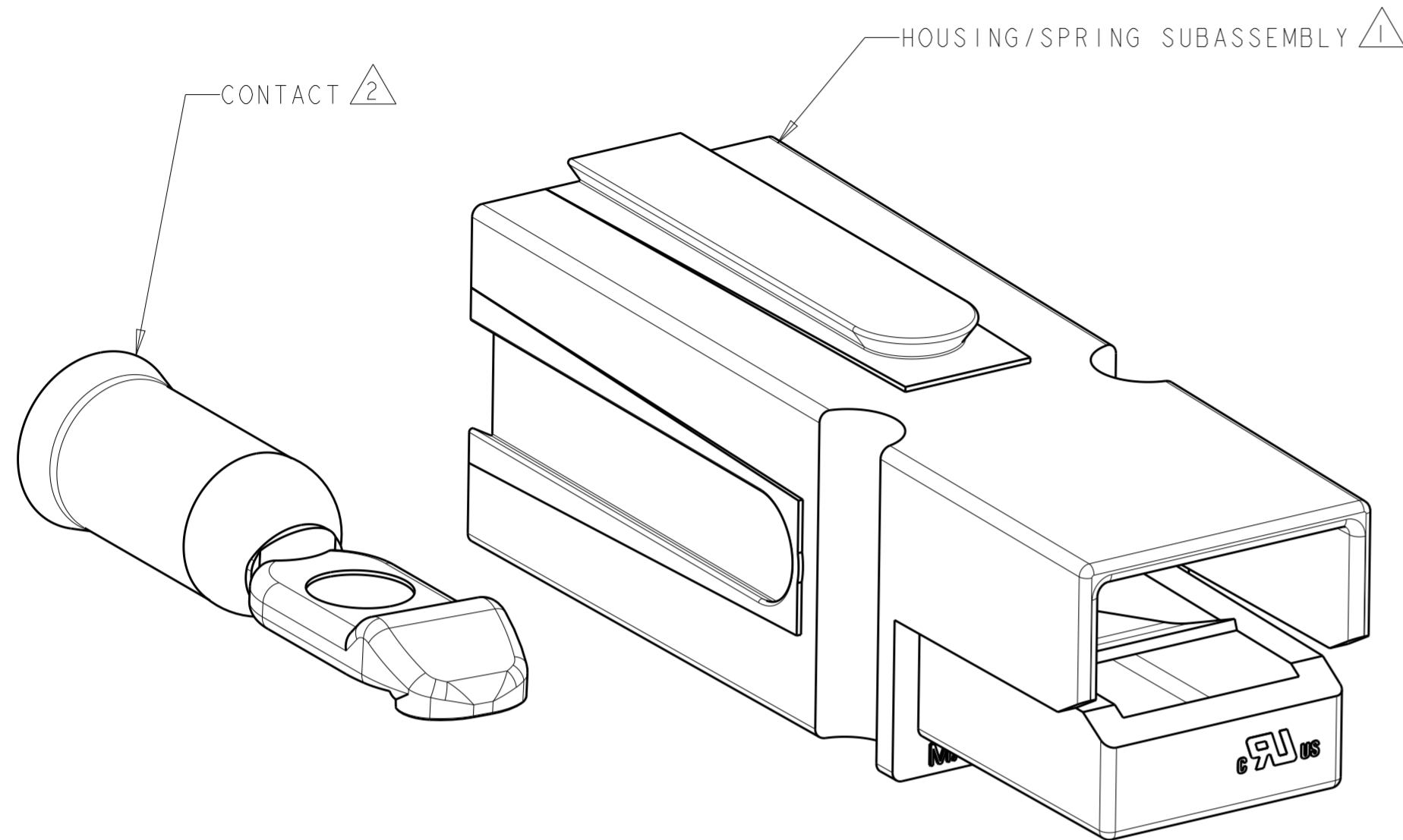

PART NUMBER 1445716-1 THRU 1445716-5
(WITHOUT LOCKING FEATURE)

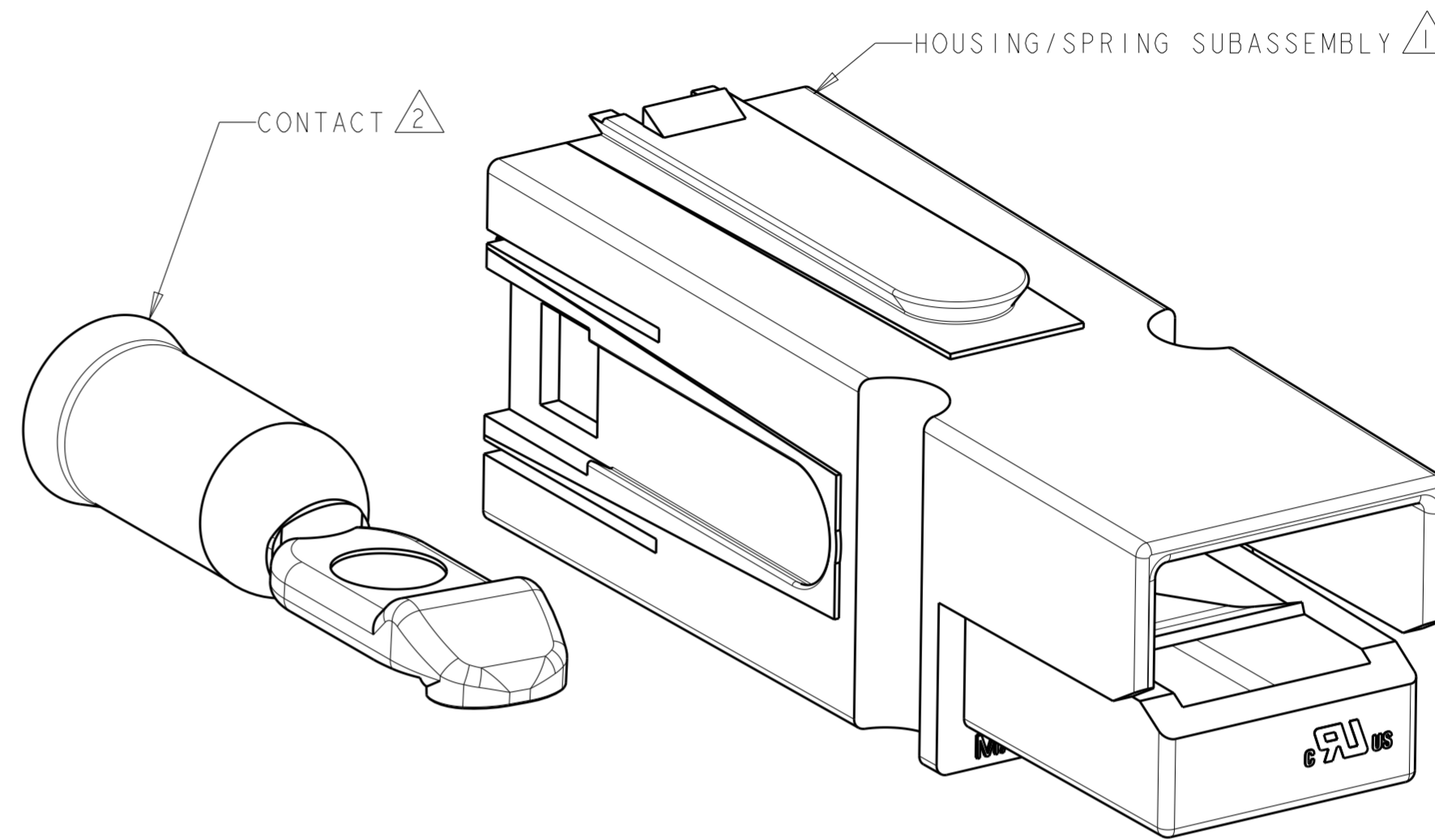

PART NUMBER 1445716-6 THRU 1-1445716-0
(WITH LOCKING FEATURE)

1 HOUSING MATERIAL: POLYCARBONATE UL94VO.

2 CONTACT MATERIAL: COPPER
PLATING: SILVER

3. THIS PRODUCT HAS PASSED VERIFICATION AND AGENCY APPROVALS TESTING AND IS COMPONENT RECOGNIZED PER UL 1977 AND CSA 22.2. TE CONNECTIVITY PRODUCT QUALIFICATION TESTING IS NOT YET COMPLETED.

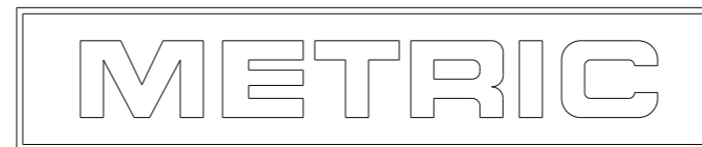

WITHOUT LOCKING FEATURE	647879-1	1445715-2 (BLACK)	1-1445716-2
WITHOUT LOCKING FEATURE	647879-1	1445715-1 (BLUE)	1-1445716-1
WITH LOCKING FEATURE	647877-1	1-1445715-0 (RED)	1-1445716-0
WITH LOCKING FEATURE	647877-1	1445715-9 (GREEN)	1445716-9
WITH LOCKING FEATURE	647877-1	1445715-8 (WHITE)	1445716-8
WITH LOCKING FEATURE	647877-1	1445715-7 (BLACK)	1445716-7
WITH LOCKING FEATURE	647877-1	1445715-6 (BLUE)	1445716-6
WITHOUT LOCKING FEATURE	647877-1	1445715-5 (RED)	1445716-5
WITHOUT LOCKING FEATURE	647877-1	1445715-4 (GREEN)	1445716-4
WITHOUT LOCKING FEATURE	647877-1	1445715-3 (WHITE)	1445716-3
WITHOUT LOCKING FEATURE	647877-1	1445715-2 (BLACK)	1445716-2
WITHOUT LOCKING FEATURE	647877-1	1445715-1 (BLUE)	1445716-1
DESCRIPTION	2 CONTACT	1 HOUSING/SPRING SUBASSEMBLY	PART NUMBER

THIS DRAWING IS A CONTROLLED DOCUMENT.		DWN BH 19OCT01	TE Connectivity			
DIMENSIONS: mm		CHK KAK 19OCT01				
TOLERANCES UNLESS OTHERWISE SPECIFIED:		APVD KAK 19OCT01				
0 PLC ± 1 PLC ± 2 PLC ±0.13 3 PLC ± 4 PLC ± ANGLES ± FINISH ±		NAME KIT, AMP POWER SERIES 75				
MATERIAL -		PRODUCT SPEC -	SIZE A2	CAGE CODE 00779	DRAWING NO C-1445716	RESTRICTED TO -
		APPLICATION SPEC -	SCALE 4:1		SHEET 1 OF 1	REV A3
		WEIGHT -	CUSTOMER DRAWING			

Mouser Electronics

Authorized Distributor

Click to View Pricing, Inventory, Delivery & Lifecycle Information:

[TE Connectivity:](#)

[1445716-3](#)