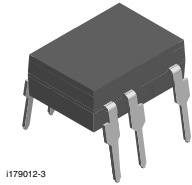
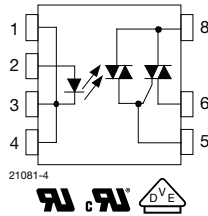


# Optocoupler, Power Phototriac



1179012-3



## FEATURES

- Maximum trigger current ( $I_{FT}$ ): 10 mA
- Isolation test voltage 5300  $V_{RMS}$
- Peak off-state voltage 600 V
- Load current 0.9  $A_{RMS}$
- $dV/dt$  of 210 V/ $\mu s$
- DIP-8 package
- Pure tin leads
- Material categorization: For definitions of compliance please see [www.vishay.com/doc?99912](http://www.vishay.com/doc?99912)


**RoHS**  
COMPLIANT

PIN	FUNCTION
1	LED cathode
2	LED anode
3	LED cathode
4	LED cathode
5	Triac gate
6	Triac T1
7	Triac T2

## DESCRIPTION

The VO2223 is an optically couple phototriac driving a power triac in a DIP-8 package. It provides a 5300 V of input to output isolation.

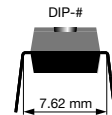
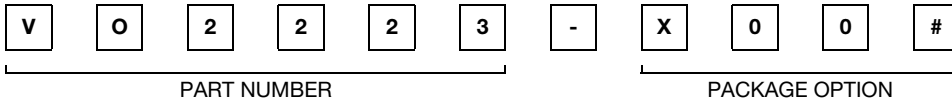
## APPLICATIONS

- Home appliances (air conditioners, microwave ovens, washing machines, personal hygiene systems, refrigerators, fan heaters, inductive heating cooker, water heaters, etc.)
- Industrial equipments

## AGENCY APPROVALS

- UL - E52744 system code H
- cUL - E52744 system code H
- VDE - DIN EN 60747-5-5 (VDE 0884-5)

## ORDERING INFORMATION



AGENCY CERTIFIED/PACKAGE	TRIGGER, CURRENT $I_{FT}$ (mA)
UL, cUL	10
DIP-8	VO2223
VDE, UL, cUL	10
DIP-8	VO2223-X001

## ABSOLUTE MAXIMUM RATINGS ( $T_{amb} = 25\text{ }^{\circ}\text{C}$ , unless otherwise specified)

PARAMETER	TEST CONDITION	SYMBOL	VALUE	UNIT
<b>INPUT</b>				
LED continuous forward current		$I_F$	50	mA
LED reverse voltage		$V_R$	6	V
<b>OUTPUT</b>				
Repetitive peak off-state voltage	Sine wave, 50 Hz to 60 Hz, gate open	$V_{DRM}$	600	V
On-state RMS current		$I_{T(RMS)}$	0.9	A
Peak non-repetitive surge current (60 Hz, 1 cycle)		$I_{TSM}$	9	A
<b>COUPLER</b>				
Total power dissipation <sup>(2)</sup>		$P_{diss}$	1.2	W
Ambient temperature range		$T_{amb}$	- 40 to + 85	$^{\circ}\text{C}$
Storage temperature range		$T_{stg}$	- 40 to + 125	$^{\circ}\text{C}$
Soldering temperature <sup>(1)</sup>	$t \leq 10$ s max.	$T_{slid}$	260	$^{\circ}\text{C}$
Isolation test voltage	for 1 s	$V_{ISO}$	5300	$V_{RMS}$

## Notes

- Stresses in excess of the absolute maximum ratings can cause permanent damage to the device. Functional operation of the device is not implied at these or any other conditions in excess of those given in the operational sections of this document. Exposure to absolute maximum ratings for extended periods of the time can adversely affect reliability.
- <sup>(1)</sup> Refer to wave profile for soldering conditions for through hole devices.
- <sup>(2)</sup> Total power dissipation value is based on 2S2P PCB.

**ABSOLUTE MAXIMUM RATING CURVES**

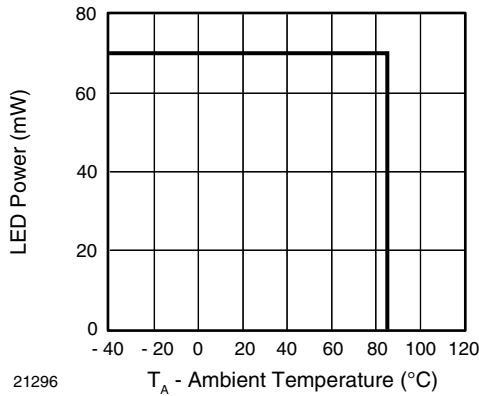


Fig. 1 - Power Dissipation vs. Temperature

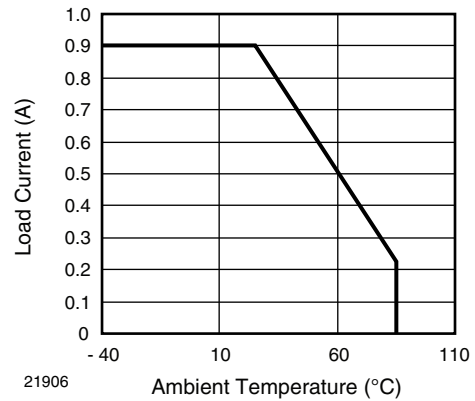


Fig. 2 - Allowable Load Current vs. Ambient Temperature

**Note**

- The allowable load current was calculated out under a given operating conditions and only for reference:  
LED power:  $Q_E = 0.015 \text{ W}$ ,  $\theta_{BA} \text{ (4-layer)} = 30 \text{ }^\circ\text{C/W}$

<b>ELECTRICAL CHARACTERISTICS</b> ( $T_{amb} = 25 \text{ }^\circ\text{C}$ , unless otherwise specified)						
PARAMETER	TEST CONDITION	SYMBOL	MIN.	TYP.	MAX.	UNIT
<b>INPUT</b>						
LED trigger current	$V_T = 6 \text{ V}$	$I_{FT}$			10	mA
LED reverse current	$V_R = 5 \text{ V}$	$I_R$			10	$\mu\text{A}$
LED forward voltage	$I_F = 10 \text{ mA}$	$V_F$	0.9		1.3	V
<b>OUTPUT</b>						
Peak on-state voltage	$I_F = 10 \text{ mA}$ , $I_{TM} = \text{max.}$	$V_{TM}$			2.5	V
Peak off-state current	$I_F = 10 \text{ mA}$ , $V_{DRM} = 600 \text{ V}$	$I_{DRM}$			100	$\mu\text{A}$
Holding current	$R_L = 100 \text{ } \Omega$	$I_H$			25	mA
Critical rate of rise of off-state voltage	$V_{IN} = 400 \text{ V}_{RMS}$ (fig. 3)	$dV/dt_{cr}$		210		$\text{V}/\mu\text{s}$
Critical rate of rise of commutating voltage	$V_{IN} = 240 \text{ V}_{RMS}$ , $I_T = 1 \text{ A}_{RMS}$ (fig. 3)	$dV/dt_{crq}$		0.7		$\text{V}/\mu\text{s}$

**Note**

- Minimum and maximum values are testing requirements. Typical values are characteristics of the device and are the result of engineering evaluations. Typical values are for information only and are not part of the testing requirements.

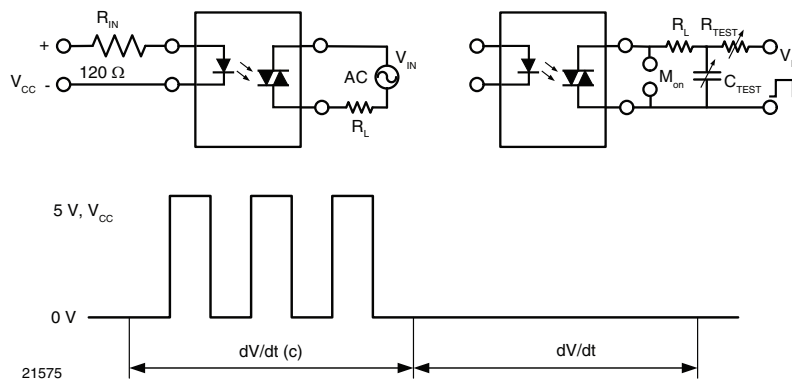


Fig. 3 - dV/dt Test Circuit

SAFETY AND INSULATION RATINGS						
PARAMETER	TEST CONDITION	SYMBOL	MIN.	TYP.	MAX.	UNIT
Climatic classification	IEC 68 part 1			40/85/21		
Pollution degree	DIN VDE0109			2		
Tracking resistance (comparative tracking index)	Insulation group IIIa	CTI	175			
Highest allowable overvoltage	Transient overvoltage	$V_{IOTM}$	8000			$V_{peak}$
Maximum working insulation voltage	Recurring peak voltage	$V_{IORM}$	890			$V_{peak}$
Insulation resistance at 25 °C	$V_{IO} = 500\text{ V}$	$R_{IS}$			$\geq 10^{12}$	$\Omega$
Insulation resistance at $T_S$	$V_{IO} = 500\text{ V}$	$R_{IS}$			$\geq 10^9$	$\Omega$
Insulation resistance at 100 °C	$V_{IO} = 500\text{ V}$	$R_{IS}$			$\geq 10^{11}$	$\Omega$
Partial discharge test voltage	Method b, $V_{pd} = V_{IORM} \times 1.6$	$V_{pd}$			1424	$V_{peak}$
Safety limiting values - maximum values allowed in the event of a failure	Case temperature	$T_{SI}$			165	°C
	Input current	$I_{SI}$			150	mA
	Output power	$P_{SO}$			2000	mW
Minimum external air gap (clearance distance)	Measured from input terminals to output terminals, shortest distance through air		$\geq 7$			mm
Minimum external tracking (creepage distance)	Measured from input terminals to output terminals, shortest distance path along body		$\geq 7$			mm

**Note**

- This phototriac coupler is suitable for "Safe Electrical Insulation" only within the safety ratings. Compliance with safety ratings shall be ensured by means of protective circuits.

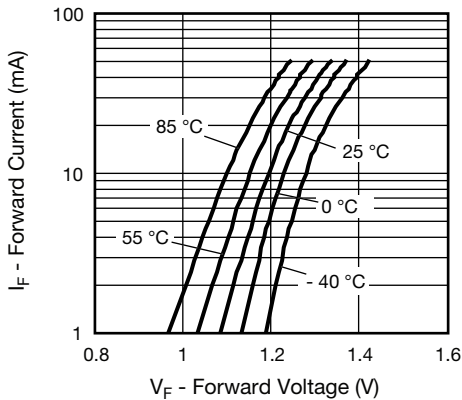
**TYPICAL CHARACTERISTICS** ( $T_{amb} = 25\text{ °C}$ , unless otherwise specified)


Fig. 4 - Forward Current vs. Forward Voltage

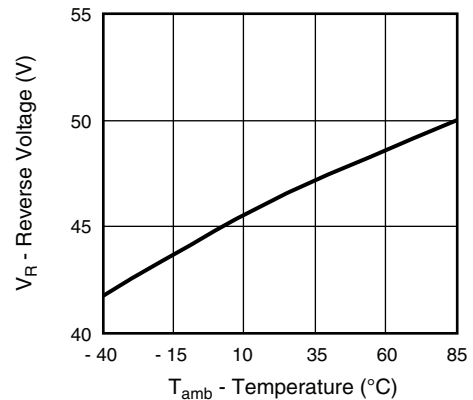


Fig. 5 - Reverse Voltage vs. Temperature

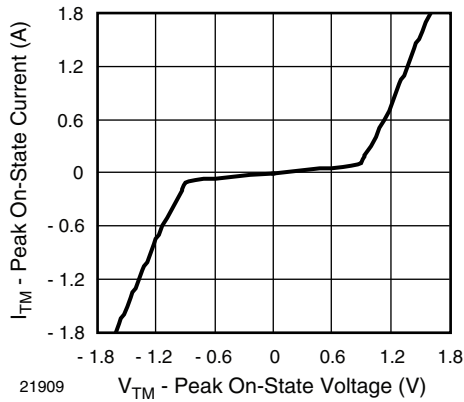


Fig. 6 - On-State Current vs. On-State Voltage

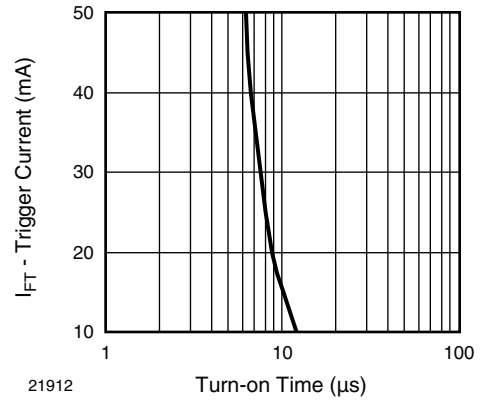


Fig. 9 - Trigger Input Current vs. Turn-on Time

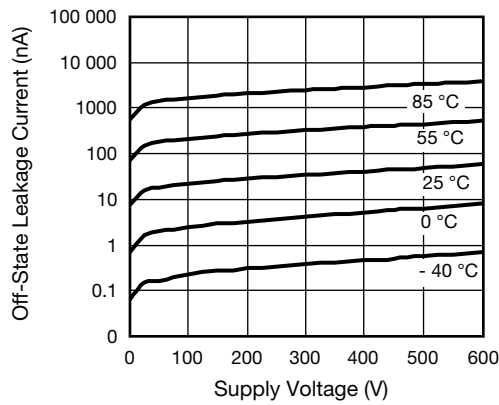


Fig. 7 - Off-State Leakage Current vs. Voltage

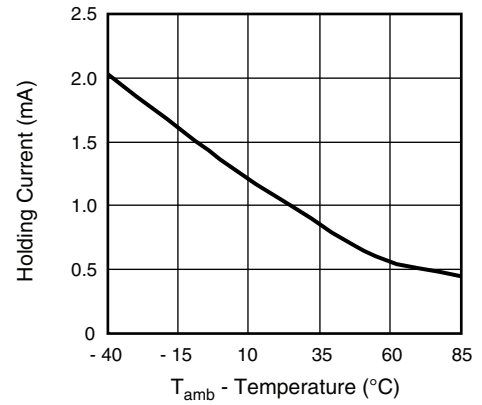


Fig. 10 - Normalized Holding Current vs. Temperature

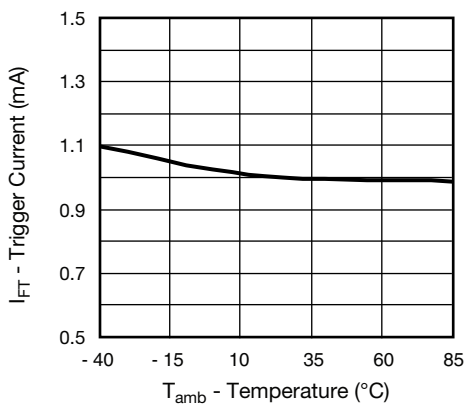


Fig. 8 - Normalized Trigger Input Current vs. Temperature

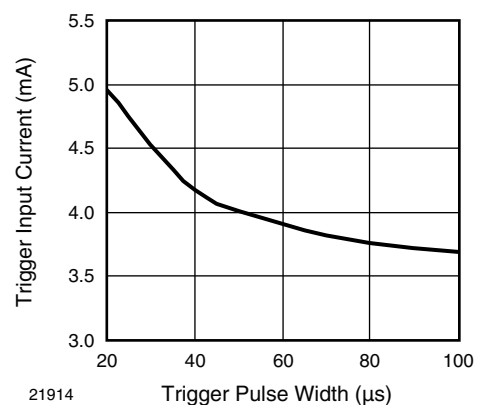


Fig. 11 - Trigger Current vs. Trigger Pulse Width

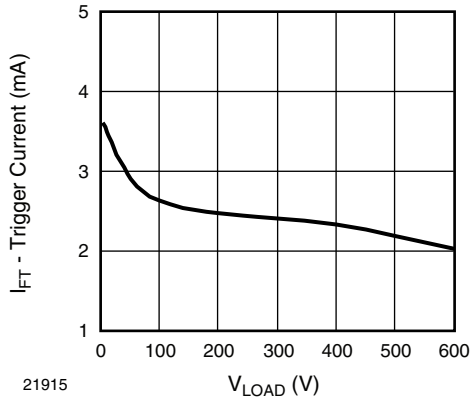
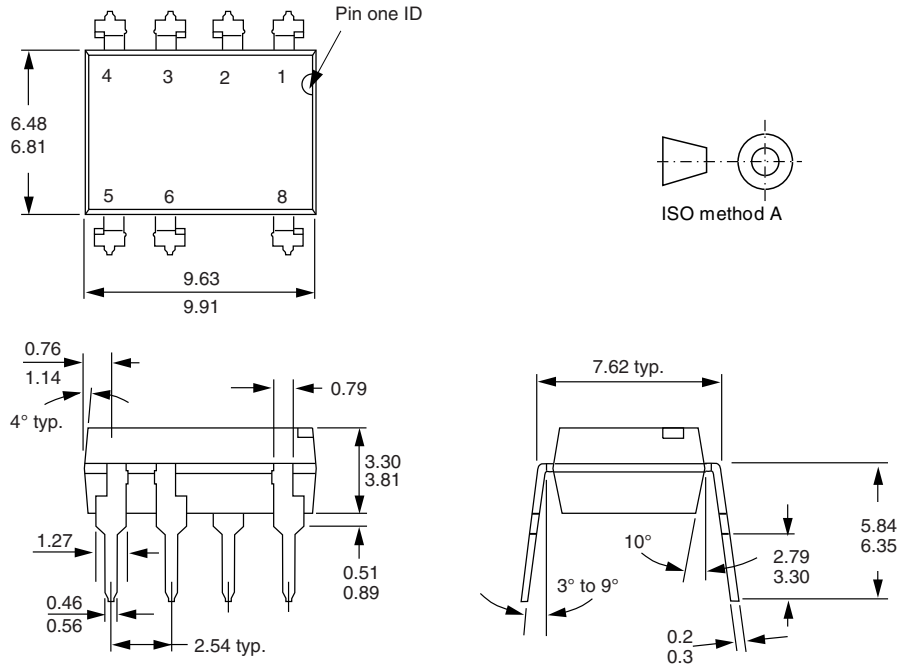


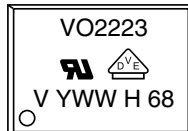
Fig. 12 - Trigger Current vs. V\_LOAD

**PACKAGE DIMENSIONS** in millimeters



i178006-1

**PACKAGE MARKING** (example of VO2223-X001)





## **Disclaimer**

ALL PRODUCT, PRODUCT SPECIFICATIONS AND DATA ARE SUBJECT TO CHANGE WITHOUT NOTICE TO IMPROVE RELIABILITY, FUNCTION OR DESIGN OR OTHERWISE.

Vishay Intertechnology, Inc., its affiliates, agents, and employees, and all persons acting on its or their behalf (collectively, "Vishay"), disclaim any and all liability for any errors, inaccuracies or incompleteness contained in any datasheet or in any other disclosure relating to any product.

Vishay makes no warranty, representation or guarantee regarding the suitability of the products for any particular purpose or the continuing production of any product. To the maximum extent permitted by applicable law, Vishay disclaims (i) any and all liability arising out of the application or use of any product, (ii) any and all liability, including without limitation special, consequential or incidental damages, and (iii) any and all implied warranties, including warranties of fitness for particular purpose, non-infringement and merchantability.

Statements regarding the suitability of products for certain types of applications are based on Vishay's knowledge of typical requirements that are often placed on Vishay products in generic applications. Such statements are not binding statements about the suitability of products for a particular application. It is the customer's responsibility to validate that a particular product with the properties described in the product specification is suitable for use in a particular application. Parameters provided in datasheets and / or specifications may vary in different applications and performance may vary over time. All operating parameters, including typical parameters, must be validated for each customer application by the customer's technical experts. Product specifications do not expand or otherwise modify Vishay's terms and conditions of purchase, including but not limited to the warranty expressed therein.

Except as expressly indicated in writing, Vishay products are not designed for use in medical, life-saving, or life-sustaining applications or for any other application in which the failure of the Vishay product could result in personal injury or death. Customers using or selling Vishay products not expressly indicated for use in such applications do so at their own risk. Please contact authorized Vishay personnel to obtain written terms and conditions regarding products designed for such applications.

No license, express or implied, by estoppel or otherwise, to any intellectual property rights is granted by this document or by any conduct of Vishay. Product names and markings noted herein may be trademarks of their respective owners.