

Installation general information

Socket outlets, switches and other MK wiring accessories can be wall or bench mounted. Do not use a trailing lead for sockets and connection units or mount any devices where they may be subject to excessive moisture or dampness.

Cable management

Socket outlets, switches and other MK wiring accessories can be mounted in a variety of MK trunking systems.

13A Socket Outlets

Standards and approvals

13A socket outlets comply with BS 1363 Part 2:1995.

Replacement fuses to the 3 gang switchsocket outlets (Logic Plus only) comply with BS 1362:1973.

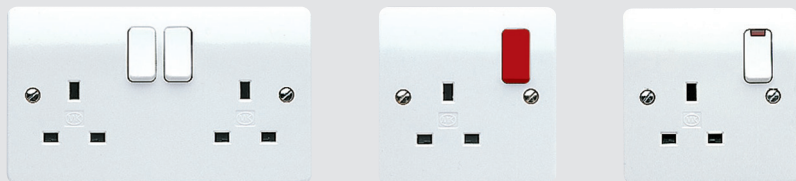

Description

A range of socket outlets designed for ease of installation and having all the advantageous design features of the MK range of wiring devices. The 2 gang sockets with outboard rockers (available in Logic Plus and Albany Plus) are of particular value for use by the infirm and partially sighted whilst the same feature in Metalclad Plus is ideal for use with gloved hands.

Non-standard clean earth sockets are for use on installations where restricted access is required and will only accept a 647WHI 13A non-standard plug with T-shaped earth pin. The sockets have two independent earth terminals so that they can also be used for 'clean earth' installations. The K2746CE and K2947CE also have two independent earth terminals for 'clean earth' installations.

A variety of sockets (see Technical Specification) are fitted with two earth terminals on a common busbar to provide a double earth facility for use when installations require a high integrity protective connection as specified within the latest edition of BS 7671 which should be referred to for guidance.

The products can be quickly installed as replacement for existing 13A sockets or in a new installation.

Fuse carriers

(Logic Plus 3 gang switchsocket only)

The fuse carrier is opened by a fast-acting, screwdriver-operated, worm-drive screw for ease of replacement.

TECHNICAL SPECIFICATION

ELECTRICAL

VOLTAGE RATING

250V a.c.

CURRENT RATING

13A

(3 Gang Switchsocket 13A total)

TERMINAL CAPACITY

Live, neutral & earth

3 x 2.5mm²

3 x 4mm²

2 x 6mm² (standard)

(Dual earth terminals on list Nos. K781, K2657, K2737, K2746, K2757, all standard Edge and Aspect sockets, K733, K2958, K2458, K2947, K2947D6, K850, K2977, K2477, K3045, K3077, K2945, K2945D6 and K5357)

PHYSICAL

AMBIENT OPERATING TEMPERATURE

-5°C to +40°C

IP RATING

IP2XD

MAX. INSTALLATION ALTITUDE

2000 metres

13A Socket Outlets

Installation

1 gang switchsocket – view from rear

Top-facing, angled, backed-out terminals make wiring easier and quicker.



FEATURES

- Moulded 'on' indicator flash on plastic switches will not rub off – totally safe
- Matching Metal rocker Switches (Edge™ and Aspect only)
- Optional neon indicators in the switch rockers with 175° visibility in the horizontal and vertical planes
- 3 pin operated safety shutter
- Printed terminal markings on grey rear mouldings for clearer identification
- Top access, angled terminals make wiring easier and quicker
- 3mm minimum switch contact gap
- Double pole switching
- Choice of inboard or outboard positioned rockers
- Additional electrical safety from DP Switch, neutral 'make first', 'break last' feature
- Switch contacts with silver contacts on both surfaces for good continuity
- Only one size of screwdriver required for installation
- Selection of products incorporating dual earth terminals for high integrity earthing
- Backed out and captive terminal screws
- 'Clean earth' sockets available
- Non-standard 'clean earth' sockets available

Wiring Devices Technical

– Logic Plus™

2 Gang Switchsocket Outlet with Integrated Dual USB Charging Capability

Standards and approvals

Logic Plus™ 13A socket outlets and 2A USB charging outlets comply with BS 5733 and IEC 61558-2-16.

EMC Compatibility:

IEC 61000-6-1

IEC 61000-6-3

Products are CE marked and meet the requirements of the Low Voltage, EMC, RoHS and WEEE directives.



TECHNICAL SPECIFICATION

13A SOCKET OUTLETS

ELECTRICAL

VOLTAGE RATING

220-240V

CURRENT RATING

13A

Combined total 2A drawn from USB outlets

STANDBY POWER

150mW

TERMINAL CAPACITY

Live, neutral & earth

3 x 2.5mm²

3 x 4mm²

2 x 6mm² (stranded)

PHYSICAL

AMBIENT OPERATING TEMPERATURE

-5°C to +40°C

IP RATING

IP2XD

MAX. INSTALLATION ALTITUDE

2000 metres

Description

A range of socket outlets designed for ease of installation and having all the advantageous design features of the Logic Plus™ range. Dual USB charging outlets offer end users easy access to power for charging a variety of devices such as smart phones, tablets and cameras.

FEATURES

- Moulded 'on' indicator flash on switches will not rub off – totally safe
 - 3 pin operated safety shutter on 13A socket outlets
 - USB 2.0 and 3.0 compatible
 - Can charge a device at up to a full 2A
 - If only one device is connected to a USB outlet the total output current of 2A is available from either outlet
 - If two devices are connected to USB outlets the the total rated current of 2A is divided between the two outlets
 - Differing manufacturers devices can be charged simultaneously via the two USB outlets
 - If the total charging current exceeds the rated level of 2A then the device will enter a current limiting safety mode
 - Electronically protected against an overload or short circuit on either USB outlet
- USB outlets are designed to provide optimum charging compatibility across a wide range of devices
 - Printed terminal markings on grey rear mouldings for clearer identification
 - Top access, angled terminals make wiring easier and quicker
 - 3mm minimum switch contact gap
 - Double pole switching
 - Additional electrical safety from neutral 'make first', 'break last' feature
 - Switch contacts with silver contacts on both surfaces for good continuity
 - Backed out and captive terminal screws
 - Dual earthed

Installation

Logic Plus™ socket outlets can be wall or bench mounted.

Do not mount or use as a trailing socket or where they may be subject to excessive moisture or damp.

Cable management

Logic Plus™ socket outlets can be mounted in a variety of MK trunking systems.

BOX TYPES WITHOUT PATRESS

GANG	FLUSH	SURFACE INSULATED	SURFACE METAL
	DEPTH 35MM	DEPTH 40MM	DEPTH 41MM
2 GANG	886 ZIC	K2172 WHI	K2212 ALM K2214 ALM

Dimensions (mm)

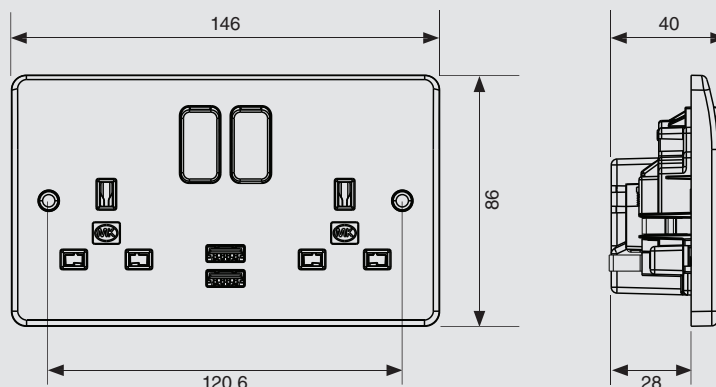

Wiring Devices Technical

– Aspect

2 Gang Switchsocket Outlet with Integrated Dual USB Charging Capability

Standards and approvals

Aspect 13A socket outlets and 2A USB charging outlets comply with BS 5733 and IEC 61558-2-16.

EMC Compatibility:

IEC 61000-6-1

IEC 61000-6-3

Products are CE marked and meet the requirements of the Low Voltage, EMC, RoHS and WEEE directives.



TECHNICAL SPECIFICATION

13A SOCKET OUTLETS

ELECTRICAL

VOLTAGE RATING

220-240V

CURRENT RATING

13A

Combined total 2A drawn from USB outlets

STANDBY POWER

150mW

TERMINAL CAPACITY

Live, neutral & earth

3 x 2.5mm²

3 x 4mm²

2 x 6mm² (stranded)

PHYSICAL

AMBIENT OPERATING TEMPERATURE

-5°C to +40°C

IP RATING

IP2XD

MAX. INSTALLATION ALTITUDE

2000 metres

Description

A range of socket outlets designed for ease of installation and having all the advantageous design features of the Aspect range. Dual USB charging outlets offer end users easy access to power for charging a variety of devices such as smart phones, tablets and cameras.

FEATURES

- Slim screwless frontplate design
- Matching metal rocker switches
- 3 pin operated safety shutter on 13A socket outlets
- USB 2.0 and 3.0 compatible
- Can charge a device at up to a full 2A
- If only one device is connected to a USB outlet the total output current of 2A is available from either outlet
- If two devices are connected to USB outlets the total rated current of 2A is divided between the two outlets
- Differing manufacturers devices can be charged simultaneously via the two USB outlets
- If the total charging current exceeds the rated level of 2A then the device will enter a current limiting safety mode
- Electronically protected against an overload or short circuit on either USB outlet
- USB outlets are designed to provide optimum charging compatibility across a wide range of devices
- Printed terminal markings on grey rear mouldings for clearer identification
- Top access, angled terminals make wiring easier and quicker
- 3mm minimum switch contact gap
- Double pole switching
- Additional electrical safety from neutral 'make first', 'break last' feature
- Switch contacts with silver contacts on both surfaces for good continuity
- Backed out and captive terminal safety screws
- Dual earthed

Installation

Aspect socket outlets can be wall or bench mounted.

Do not mount or use as a trailing socket or where they may be subject to excessive moisture or damp.

Cable management

Aspect socket outlets can be mounted in a variety of MK trunking systems.

BOX TYPES WITHOUT PATRESS

GANG	FLUSH
2 GANG	DEPTH 47MM
	878 ZIC

Dimensions (mm)

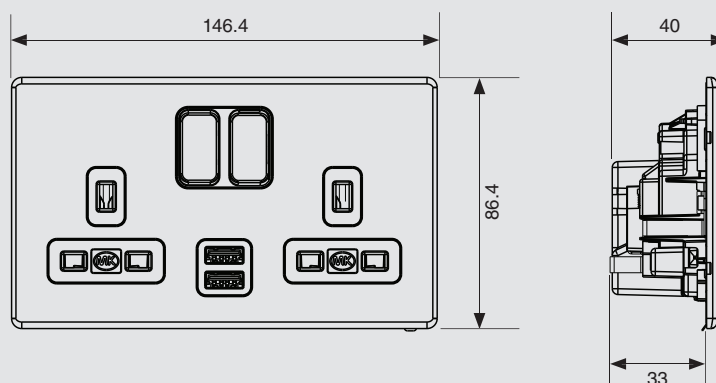

Wiring Devices Technical

– Edge™

2 Gang Switchsocket Outlet with Integrated Dual USB Charging Capability

Standards and approvals

Edge™ 13A socket outlets and 2A USB charging outlets comply with BS 5733 and IEC 61558-2-16.

EMC Compatibility:

IEC 61000-6-1

IEC 61000-6-3

Products are CE marked and meet the requirements of the Low Voltage, EMC, RoHS and WEEE directives.



TECHNICAL SPECIFICATION

13A SOCKET OUTLETS

ELECTRICAL

VOLTAGE RATING

220-240V

CURRENT RATING

13A

Combined total 2A drawn from USB outlets

STANDBY POWER

150mW

TERMINAL CAPACITY

Live, neutral & earth

3 x 2.5mm²

3 x 4mm²

2 x 6mm² (stranded)

PHYSICAL

AMBIENT OPERATING TEMPERATURE

-5°C to +40°C

IP RATING

IP2XD

MAX. INSTALLATION ALTITUDE

2000 metres

Description

A range of socket outlets designed for ease of installation and having all the advantageous design features of the Edge™ range. Dual USB charging outlets offer end users easy access to power for charging a variety of devices such as smart phones, tablets and cameras.

FEATURES

- Matching metal rocker switches
- 3 pin operated safety shutter on 13A socket outlets
- USB 2.0 and 3.0 compatible
- Can charge a device at up to a full 2A
- If only one device is connected to a USB outlet the total output current of 2A is available from either outlet
- If two devices are connected to USB outlets the the total rated current of 2A is divided between the two outlets
- Differing manufacturers devices can be charged simultaneously via the two USB outlets
- If the total charging current exceeds the rated level of 2A then the device will enter a current limiting safety mode
- Electronically protected against an overload or short circuit on either USB outlet
- USB Outlets are designed to provide optimum charging compatibility across a wide range of devices
- Printed terminal markings on grey rear mouldings for clearer identification
- Top access, angled terminals make wiring easier and quicker
- 3mm minimum switch contact gap
- Double pole switching
- Additional electrical safety from neutral 'make first', 'break last' feature
- Switch contacts with silver contacts on both surfaces for good continuity
- Backed out and captive terminal screws
- Dual earthed

Installation

Edge™ socket outlets can be wall or bench mounted.

Do not mount or use as a trailing socket or where they may be subject to excessive moisture or damp.

Cable management

Edge™ socket outlets can be mounted in a variety of MK trunking systems.

BOX TYPES WITHOUT PATRESS

GANG	FLUSH
2 GANG	DEPTH 47MM
	878 ZIC

Dimensions (mm)

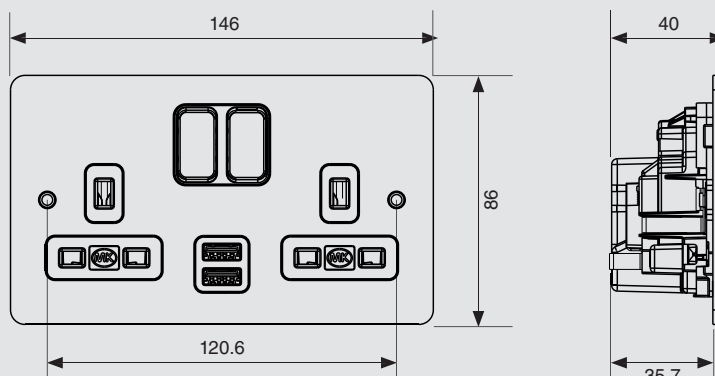

Wiring Devices Technical

– Albany Plus™

mkelectric.co.uk



2 Gang Switchsocket Outlet with Integrated Dual USB Charging Capability

Standards and approvals

Albany Plus™ 13A socket outlets and 2A USB charging outlets comply with BS 5733 and IEC 61558-2-16.

EMC Compatibility:

IEC 61000-6-1

IEC 61000-6-3

Products are CE marked and meet the requirements of the Low Voltage, EMC, RoHS and WEEE directives.

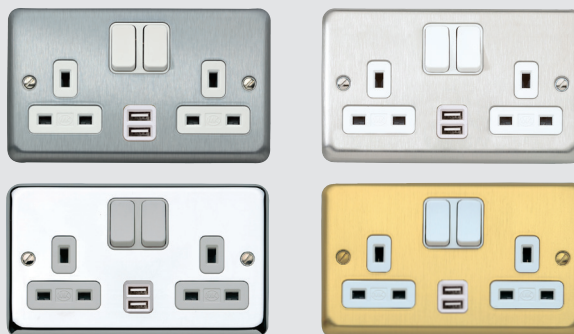

TECHNICAL SPECIFICATION

13A SOCKET OUTLETS

ELECTRICAL

VOLTAGE RATING

220-240V

CURRENT RATING

13A

Combined total 2A drawn from USB outlets

STANDBY POWER

150mW

TERMINAL CAPACITY

Live, neutral & earth

3 x 2.5mm²

3 x 4mm²

2 x 6mm² (stranded)

PHYSICAL

AMBIENT OPERATING TEMPERATURE

-5°C to +40°C

IP RATING

IP2XD

MAX. INSTALLATION ALTITUDE

2000 metres

Description

A range of socket outlets designed for ease of installation and having all the advantageous design features of the Albany Plus™ range. Dual USB charging outlets offer end users easy access to power for charging a variety of devices such as smart phones, tablets and cameras.

FEATURES

- Moulded 'on' indicator flash on switches will not rub off – totally safe
- 3 pin operated safety shutter on 13A socket outlets
- USB 2.0 and 3.0 compatible
- Can charge a device at up to a full 2A
- If only one device is connected to a USB outlet the total output current of 2A is available from either outlet
- If two devices are connected to USB outlets the the total rated current of 2A is divided between the two outlets
- Differing manufacturers devices can be charged simultaneously via the two USB outlets
- If the total charging current exceeds the rated level of 2A then the device will enter a current limiting safety mode
- Electronically protected against an overload or short circuit on either USB outlet
- USB outlets are designed to provide optimum charging compatibility across a wide range of devices
- Printed terminal markings on grey rear mouldings for clearer identification
- Top access, angled terminals make wiring easier and quicker
- 3mm minimum switch contact gap
- Double pole switching
- Additional electrical safety from neutral 'make first', 'break last' feature
- Switch contacts with silver contacts on both surfaces for good continuity
- Backed out and captive terminal screws
- Dual earthed

Installation

Albany Plus™ socket outlets can be wall or bench mounted.

Do not mount or use as a trailing socket or where they may be subject to excessive moisture or damp.

Cable management

Albany Plus™ socket outlets can be mounted in a variety of MK trunking systems.

BOX TYPES WITHOUT PATRESS

GANG	FLUSH	SURFACE INSULATED	SURFACE METAL
2 GANG	DEPTH 35MM	DEPTH 40MM	DEPTH 41MM
	886 ZIC	K2172 WHI	K2212ALM / K2214ALM

Dimensions (mm)

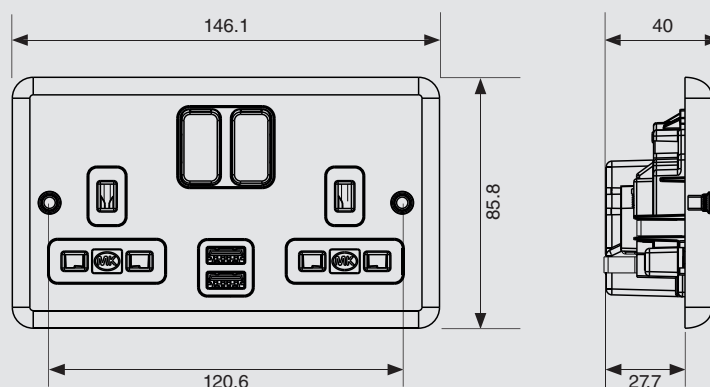



Technical Hotline
+44 (0)1268 563720

Wiring Devices Technical – Metalclad Plus™

2 Gang Switchsocket Outlet with Integrated Dual USB Charging Capability

Standards and approvals

Metalclad Plus™ 13A socket outlets and 2A USB charging outlets comply with BS 5733 and IEC 61558-2-16.

EMC Compatibility:

IEC 61000-6-1

IEC 61000-6-3

Products are CE marked and meet the requirements of the Low Voltage, EMC, RoHS and WEEE directives.



TECHNICAL SPECIFICATION

13A SOCKET OUTLETS

ELECTRICAL

VOLTAGE RATING

220-240V

CURRENT RATING

13A

Combined total 2A drawn from USB outlets

STANDBY POWER

150mW

TERMINAL CAPACITY

Live, neutral & earth

3 x 2.5mm²

3 x 4mm²

2 x 6mm² (stranded)

PHYSICAL

AMBIENT OPERATING TEMPERATURE

-5°C to +40°C

IP RATING

IP2XD

MAX. INSTALLATION ALTITUDE

2000 metres

Description

A range of socket outlets designed for ease of installation and having all the advantageous design features of the Metalclad Plus™ range. Dual USB charging outlets offer end users easy access to power for charging a variety of devices such as smart phones, tablets and cameras.

FEATURES

- Moulded 'on' indicator flash on switches will not rub off – totally safe
- 3 pin operated safety shutter on 13A socket outlets
- USB 2.0 and 3.0 compatible
- Can charge a device at up to a full 2A
- If only one device is connected to a USB outlet the total output current of 2A is available from either outlet
- If two devices are connected to USB outlets the the total rated current of 2A is divided between the two outlets
- Differing manufacturers devices can be charged simultaneously via the two USB outlets
- If the total charging current exceeds the rated level of 2A then the device will enter a current limiting safety mode
- Electronically protected against an overload or short circuit on either USB outlet
- USB outlets are designed to provide optimum charging compatibility across a wide range of devices
- Printed terminal markings on grey rear mouldings for clearer identification
- Top access, angled terminals make wiring easier and quicker
- 3mm minimum switch contact gap
- Double pole switching
- Additional electrical safety from neutral 'make first', 'break last' feature
- Switch contacts with silver contacts on both surfaces for good continuity
- Backed out and captive terminal screws
- Metallic powder paint finish is corrosion and scratch resistant
- Dual earthed
- High impact resistance

Installation

Metalclad Plus™ socket outlets can be wall or bench mounted.

Do not mount or use as a trailing socket or where they may be subject to excessive moisture or damp.

Cable management

Metalclad Plus™ socket outlets can be mounted in a variety of MK trunking systems.

BOX TYPES WITHOUT PATRESS

GANG	FLUSH	SURFACE
2 GANG	DEPTH 35MM	DEPTH 38MM
	886 ZIC	K830 ALM (without knockouts) K897 ALM and K897 WHI (with 8 x 20mm knockouts)

Dimensions (mm)

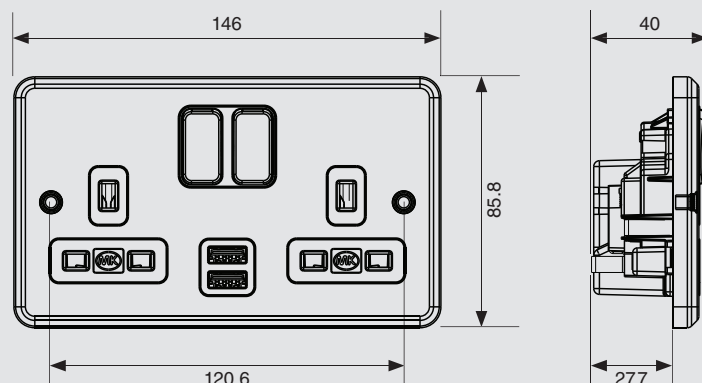

Sentrysocket

Compliance with EC Directives, Standards and approvals

All Sentrysockets comply with the following EC Directives and are CE marked:

Low Voltage Directive
Electromagnetic Compatibility Directive (89/336/EEC)

Sentrysocket RCD DP Single Sockets comply with the requirements of the following standards:

BS 7288:1990
BS EN 50082-1:1998

Sentrysocket RCD SP Double Sockets also comply with the requirements of BS EN 61543:1996.

TECHNICAL SPECIFICATION

ELECTRICAL

RATED VOLTAGE
240V a.c.

CURRENT RATING
13A resistive
Rated tripping current 10mA/30mA

TERMINAL CAPACITY
3 x 4mm² for 1 gang
2 x 4mm² for 2 gang

PHYSICAL

AMBIENT OPERATING TEMPERATURE
-5°C to +40°C

IP RATING
IP2XD
IP66 (K56301/K56231/K56233)

MAX. INSTALLATION ALTITUDE
2000 metres

Sentrysockets are not suitable for connection across two lines of a 127V line to Neutral Voltage System

Cable management

Logic Plus™, Albany Plus™ and Metalclad Plus™ Sentrysockets can be mounted in a variety of MK trunking systems.

Installation

Flush mounting steel wall box

It should be noted that some of the conduit entries may be restricted, depending upon their positions and the depth of box used.

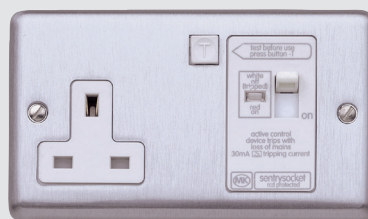

Description

Sentrysocket provides a high level of protection against electrocution and gives further protection when used with appliances vulnerable to insulation damage, particularly when they are in damp environments or outdoors. The Sentrysocket units are not suitable for mounting in damp environments or outdoors.

Sentrysocket, incorporating an RCD, is part of a complete range of fixed and portable wiring devices and circuit protection devices suitable for use in domestic, commercial and light industrial applications.

Active control circuits

Incorporate a 'Re-set' mechanism and are mains failure sensitive, i.e. they will function under all the normal conditions expected of an RCD, but will also trip in the event of a power cut or a sudden, dramatic reduction in mains voltage. This makes them ideal for use where it would be hazardous for equipment to suddenly energise after return of mains power, such as use with rotating machinery and heat developing apparatus.

Passive control circuits

Incorporate a 'Stay-set' mechanism and is mains failure proof, i.e. it will function under all the normal conditions expected of an RCD and will not trip in the event of a power cut. This makes it suitable for use with freezers or in inaccessible or unmanned locations.

FEATURES

- Suitable for most residential, commercial and light industrial applications
- Active and passive control circuit applications
- Flexible and versatile in use
- Single Sockets have double pole switching, double sockets are single pole switching
- Masterseal Plus products are ideal for use with equipment subject to wet weather or high humidity
- Part of a complete range of MK circuit protection devices
- They are a.c. and pulsating d.c. sensitive for residual current
- Double Socket products have an enhanced RF Immunity performance

Sentrysockets products can be wall or bench mounted. Do not mount or use as a trailing socket or where they may be subject to excessive moisture or dampness.

Dimensions (mm)

Single socket

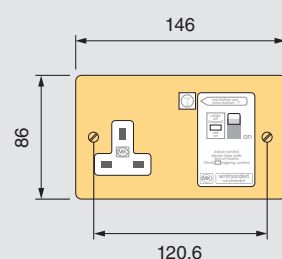

Double socket

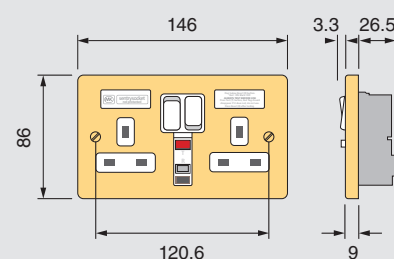

Sentrysocket

Installation

Flush mounting steel wall box

It should be noted that some of the conduit entries may be restricted, depending upon their positions and the depth of box used.

Socket Testing

Single Socket Testing

After installation, turn the mains electricity supply on.

To test that the Sentrysocket is functioning correctly:

1. Ensure that no appliance is connected to the Sentrysocket.
Switch Sentrysocket on: The switch should remain closed and the red flag will appear in the window. If the switch fails to remain closed, check that the Supply L and N connections are not reversed or the Supply N connection is not open circuit. If the Sentrysocket is correctly connected and still trips after being switched on, the Sentrysocket is faulty and should not be used.
2. If the Sentrysocket stays on, **press the test button:** The switch will open and the white flag will appear in the window. If the Sentrysocket does not trip and there is mains voltage present at the socket outlet, Sentrysocket is faulty and should not be used.
3. **Switch Sentrysocket on:** Connect an RCD tester and ensure that the Sentrysocket trips within the specified time:
≤ 200 ms AT RATED TRIP CURRENT
≤ 40 ms AT 5 x RATED TRIP CURRENT

If the Sentrysocket does not trip within the specified times then the product is faulty and should not be used (If more than one RCD is in series then there is no guarantee as to which device will trip first).
4. **Reset all tripped RCD's including the Sentrysocket.**
5. **Switch off the mains supply switch disconnecter.** On mains failure, a Sentrysocket with Active Control Circuit will trip, whilst a Sentrysocket with Passive Control Circuit will not trip. If the Active Control device does not trip, it is faulty and should not be used – see note below. If no faults have been found then installation testing has been completed successfully.

Note: If a fault is identified at any stage of installation testing procedure do not use Sentrysocket, and contact your local electrician, or your local MK stockist.

Double Socket Testing

After installation, turn the mains electricity supply on.

To test that the Sentrysocket is functioning correctly follow the steps 1 to 4 below:

1. Ensure that no appliance is connected to the Sentrysocket.
2. **Reset** – Press the button marked R (for Reset) – the contact status indicator should show red, indicating that the socket outlets are now live (if the switches are in the ON positions).
3. **Test** – Press the TEST button marked T (for Test), the product should trip with the contact status indicator showing black. In this state the socket outlets are disconnected from the supply.
4. **Reset** – Press the button marked R again, the contact status indicator should show red.
5. Connect an RCD Tester to either socket outlet and ensure that the Sentrysocket trips with the specified times below:
≤ 200 ms AT RATED TRIP CURRENT
≤ 40 ms AT 5 x RATED TRIP CURRENT
6. Reset the Sentrysocket as in step 2 above.
7. Switch off the Mains Supply Switch Disconnecter.
8. A Sentrysocket with Active Control Circuit should trip while a Sentrysocket with Passive Control Circuit should not trip.

If all the operations in steps 2 to 8 above give correct results, the Sentrysocket RCD socket outlet is safe to use.

If the procedures in steps 2 to 8 above are not completed correctly, do not use the Sentrysocket product and seek professional advice or contact the MK Technical Sales and Service department on +44 (0)1268 563720.

Filtered Switchsocket Outlets (Logic Plus and Albany Plus)

Standards and approvals

Filtered socket outlets comply with BS 5733:2010.

TECHNICAL SPECIFICATION

ELECTRICAL

CURRENT RATING

13A maximum total for 2 sockets

VOLTAGE RATING

250V a.c.

EARTH LEAKAGE

0.5 mA

SUPPRESSION

150 kHz – 30 MHz (transients)

MAXIMUM ENERGY ABSORPTION

140 Joules L – N

140 Joules L – E

TERMINAL CAPACITY

2 x 6mm²

3 x 4mm²

3 x 2.5mm²

3 x 1.5mm²

PHYSICAL

AMBIENT OPERATING TEMPERATURE

-5°C to +40°C

THERMAL OVERLOAD

The K1826 and K2826 filter socket incorporates a thermal overload device in the RFI filter section.

Overload current causes temperature rise, resulting in automatic 'trip out'. The overload device will re-set as the temperature falls.

IP RATING

IP2XD

MAX. INSTALLATION ALTITUDE

2000 metres

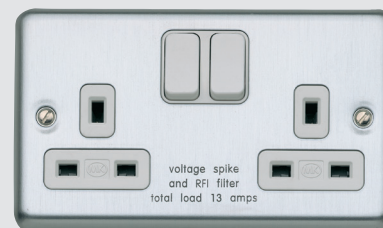
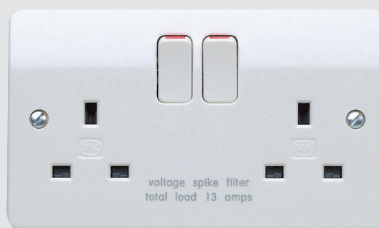

Description

A range of sockets in the Logic Plus and Albany Plus styles, designed to combat interference to or data losses on sensitive electrical products and systems due to mains borne voltage spikes and RFI.

Such systems include:

- Computer or microprocessor based equipment
- Telecommunications systems
- Electronic measurement equipment
- Cash registers
- Audio visual and hi-fi equipment

These products can be quickly installed as replacements for existing twin 13A sockets or in a new installation.

Fitted with two earth terminals to provide a double earth facility for use when installations require a high integrity protective connection as specified within the latest edition of BS 7671.

Filter cassettes

Filter cassettes are supplied with sockets and have an LED which shows green under normal conditions but will turn red or extinguish when a replacement cassette (K1800WHI) is required. An alarm will also beep at 5 second intervals to indicate replacement necessity. It can be de-activated if required.

FEATURES

- Moulded 'on' indicator flash on switches will not rub off – totally safe
- 3 pin operated safety shutter
- Printed terminal markings on grey rear mouldings for clearer identification
- Reduces risk of damage to equipment and down time
- Reduces risk of data loss
- 2 way filtering – into appliance and back into mains supply
- Additional electrical safety from DP Switch, neutral 'make first', 'break last' feature
- Double pole switches
- Dual earth terminals for high integrity earthing
- Clearly visible LED on filter cassette, changes from green to red when replacement required
- Simple replacement of cassettes
- 10 year guarantee (except filter cassette)
- 3mm minimum switch contact gap
- Backed out and captive terminal screws

Filtered Switchsocket Outlets

Product features

Ensure that the connecting pins protruding from the bottom of the replacement Filter Cassette are not damaged or bent before installation. If in doubt, contact MK Technical Sales Service Department on +44 (0)1268 563720.

The MK Filtered Switchsocket, in common with many other filters uses Voltage Dependant Resistors for spike suppression purposes. The performance of these devices will eventually degrade with use to a level where they will no longer provide adequate protection.

When this occurs the spike filter performance of the MK Filtered Switchsocket outlet can be restored by replacing the filter cassette.

When the filter cassette needs replacing, the green indicator on the Replacement Filer Cassette will glow red or go out, an audible beep every five seconds may also be heard.

Note: As with all filters, these Filter Sockets will reduce the magnitude of RFI and spikes and consequently their ability to interfere with connected equipment. They will not completely remove the interference from the supply.

Figure 1

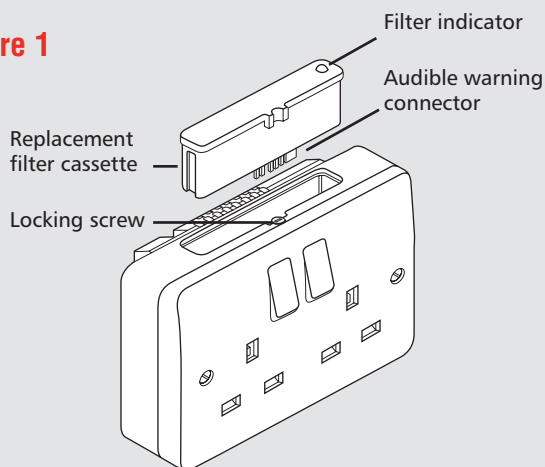

Installation

Replaceable Spike Filter Cassette

Note: To ensure a safe installation;

- this product should be installed by a competent person.
 - it is important that all connections are made as instructed.
1. The filter cassette can be removed and replaced without switching off the mains or removing any plugs from the filter socket.
 2. Remove the filter cassette by turning the jacking screw anti-clockwise to partially eject it (see Figure 2), and then gently pulling the cassette upwards, (see Figure 2a).
 3. **Only fit the MK Replacement Filter Cassette (K1800WHI).**

Unpack the new filter cassette and check that the pins along the bottom edge are not bent or broken. If these pins are damaged, do not fit the replacement cassette. The audible sound indicating that the filter cassette needs replacing, is optional. It may be prevented by removing the small connector on the two end pins, (see Figure 2b), before fitting it into the socket.

Figure 2

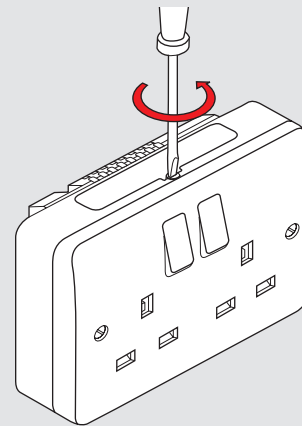

4. Fit the new filter cassette by carefully sliding it into the aperture and gently pushing it down while turning the screw clockwise until the filter cassette is flush with the surface. Do not turn the screw any further as this will cause distortion of the plastic mouldings.

Product and packaging can safely be disposed of via standard refuse facilities at the end of its useful life.

Figure 2a

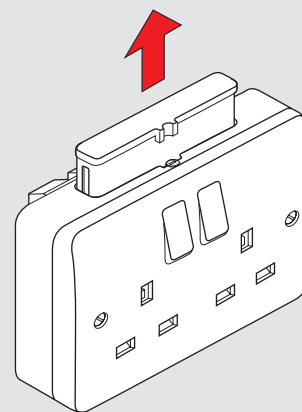
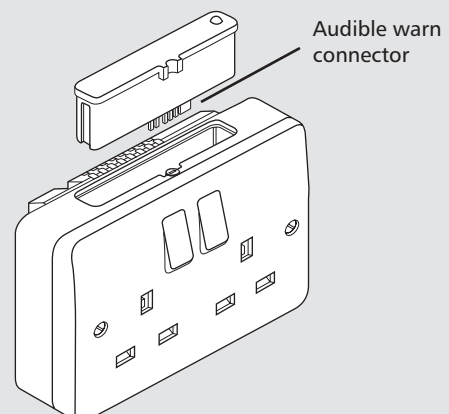

Figure 2b



Round Pin Socket Outlets

Standards and approvals

Round pin socket outlets comply with BS 546:1950.

TECHNICAL SPECIFICATION

ELECTRICAL

VOLTAGE RATING

250V a.c.

TERMINAL CAPACITIES

2A sockets:

7 x 1mm²

4 x 1.5mm²

2 x 2.5mm²

1 x 4mm²

5A sockets:

3 x 2.5mm²

2 x 4mm²

2 x 6mm² (stranded)

15A sockets:

3 x 2.5mm²

3 x 4mm²

2 x 6mm² (stranded)

PHYSICAL

AMBIENT OPERATING TEMPERATURE

-5°C to +40°C

IP RATING

IP2XD

MAX. INSTALLATION ALTITUDE

2000 metres



Description

A range of round pin socket outlets designed for ease of installation and having all the advantages and design features of the MK range of wiring devices.

These products can be quickly installed as replacements for existing socket outlets or in new installations.

FEATURES

- Top access terminals make wiring easier and quicker
- Integral ON indicator on plastic switches will not rub off – totally safe
- Switch contact gap, 3mm minimum
- Double pole switching
- Terminal screws backed out
- Additional electrical safety from neutral “make first”, “break last” feature on switched sockets
- Switch contacts with silver contact points on both surfaces for good continuity
- 5A and 15A sockets contain a 3 pin operated safety shutter.
- Printed terminal markings on grey rear mouldings for clearer identification

Non UK Socket Outlets

Standards and approvals

15A American sockets comply with SASO 2004:2003

16A 2P+E German sockets comply with IEC 60884-1:2006

TECHNICAL SPECIFICATION

ELECTRICAL

15A AMERICAN

VOLTAGE RATING
127V a.c.

CURRENT RATING
15A

TERMINAL CAPACITY
Live, neutral & earth
3 x 2.5mm²
2 x 4mm²
1 x 6mm² (stranded)

MAX. INSTALLATION ALTITUDE
2000 metres

16A 2P+E GERMAN SOCKET

VOLTAGE RATING
250V a.c.

CURRENT RATING
16A

TERMINAL CAPACITY
Live, neutral & earth
4 x 1.5mm²
2 x 2.5mm²
1 x 4mm²

PHYSICAL

AMBIENT OPERATING TEMPERATURE
-5°C to +40°C

IP RATING
IP2XD

MAX. INSTALLATION ALTITUDE
2000 metres

15A AMERICAN (Logic Plus*)



BOX TYPES			
GANG	FLUSH	FLUSH (FOR EXTRA WIRING SPACE)	SURFACE
1 GANG	861ZIC	866ZIC	K2140WHI
2 GANG	862ZIC	886ZIC	K2142WHI

16A 2P+E GERMAN (Logic Plus*)

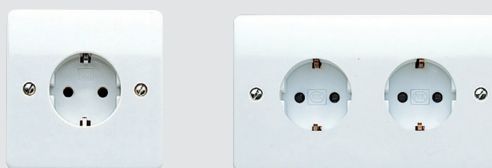

BOX TYPES		
GANG	FLUSH	SURFACE
1 GANG	861ZIC	K2140WHI
2 GANG	862ZIC	K2142WHI

Note: 16A 2P+E German Outlet: These products are NOT suitable for 25mm deep boxes.

*15A American Sockets and 16A 2P+E German Sockets are also available in a modular format for MK decorative wiring device ranges.

Three Pole Fan Isolators

Standards and approvals

Comply with BS EN 60669-2-4:2005

TECHNICAL SPECIFICATION

ELECTRICAL

VOLTAGE RATING

250V a.c.

CURRENT RATING

10A

RATED CONDITIONAL SHORT

CIRCUIT CURRENT (Inc)

3000A

TERMINAL CAPACITY

4 x 1mm²

4 x 1.5mm²

3 x 2.5mm²

2 x 4mm²

1 x 6mm²

CONTACT GAP

4mm switch contact gap

RECOMMENDED SCPD

GE Power Controls TIA32M40 32A IEC269-2-1 Fuse-link

PHYSICAL

AMBIENT OPERATING TEMPERATURE

-5°C to +40°C

IP RATING

IP4X

MAX. INSTALLATION ALTITUDE

2000 metres

Features

- Switchlock list no. K4858 is available to allow the isolator to be locked in the disconnected position to facilitate fan maintenance



Description

The MK Three Pole Fan Isolator provides a safe and simple method of isolating mechanical fan units and is particularly useful in bathrooms, toilets, storerooms and basements where there is little or no natural light.

For example, timer controlled fans are often linked into the lighting circuit for energy saving and convenience. In such an installation there is often a need for the lighting circuit to remain live to provide light whilst the fan unit is externally isolated so that routine maintenance and repairs can be carried out in complete safety.

The fan isolator can be used as a double pole or triple pole isolator. In addition it includes a clear on/off indicator and the frontplate features a fan isolator symbol for easy circuit identification.

Wiring diagrams

Two pole switching for fan units without timers

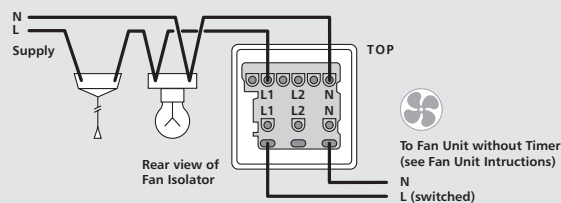
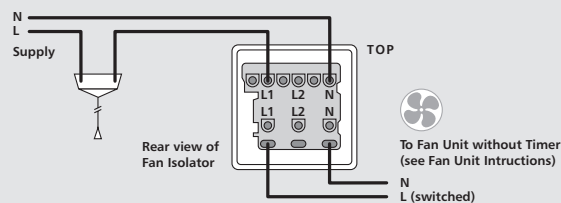

Three pole switching for fan units incorporating timers

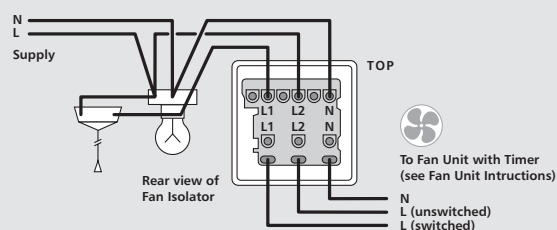
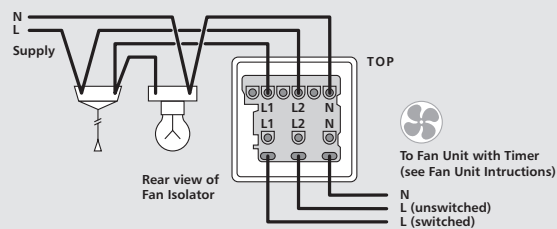

Wiring Devices Technical

– Logic Plus™

Shaver Socket Outlets

Standards and approvals

Shaver socket outlets comply with BS 4573:1970 and IEC 60884-1:2006.

Plug pin apertures, and engagement face dimensions comply with BS 4573:1970.



TECHNICAL SPECIFICATION

ELECTRICAL

VOLTAGE RATING

200-250V a.c. Input

MAXIMUM LOAD

200 mA (internal thermister trip current)

TERMINAL CAPACITIES

Each terminal will accommodate

1 x 4mm², or 2 x 2.5mm², 3 x 1.5 solid conductors

PHYSICAL

AMBIENT OPERATING TEMPERATURE

-5°C to +40°C

IP RATING

IP2XD

MAX. INSTALLATION ALTITUDE

2000 metres

Description

Designed for ease of installation and having many of the advantageous features of the Logic Plus™ range.

The shaver socket outlet accommodates the following plugs:

British 5mm dia pins on 16.6mm pitch (230V socket) to BS 4573:1970.

European 4mm dia pins on 17 to 19mm pitch (230V socket) to IEC 83:1975 Standard C5.

Australian 6.5 x 1.6 flat blades each set at 30° to the vertical on a nominal pitch of 13.7mm (230V socket).

AS C112:1964.

The fuse carrier is captive and opened by a fast acting, screwdriver operated worm drive screw for ease of replacement.

FEATURES

- Top access terminals make wiring quicker and easier
- Only one size of screwdriver required for installation
- Terminal screws supplied 'backed out' and held captive within the terminal moulding
- White printed terminal markings on grey rear mouldings for clearer identification
- Front plate fixing screws retained on rear case moulding

Installation

This shaver socket **must not** be used in bathrooms and washrooms. Non-isolated, fused, shaver socket outlets must never be installed in any location subject to splashes, condensation or damp conditions.

For installation in any other room where a wash basin or shower cubicle is installed then refer to the current IET wiring regulations.

Shaver/Toothbrush Supply Units

Standards and approvals

Shaver/Toothbrush supply units comply with BS 61558-2-5:1998

Accommodates plugs as follows:

- British 5mm dia pins on 16.6mm pitch (230V socket) to BS 4573:1970.
- European 4mm dia pins on 17 to 19mm pitch (230V socket) to BS EN 50075
- Australian 6.5 x 1.6 flat blades each set at 30° to the vertical on a nominal pitch of 13.7mm (230V socket) AS/NZS 3112:2000
- American 6.6 x 1.6 horizontal blades on 12.7mm pitch (115V socket) to UL498 / NEMA WD6.



Description

Designed for ease of installation and having many of the advantageous design features of the MK range of wiring devices.

May be used in bathrooms and washrooms – must only be installed in accordance with the latest edition of BS 7671.

TECHNICAL SPECIFICATION

ELECTRICAL

VOLTAGE RATING

K701: 230V a.c. Input (will operate at 220-250V a.c.)

K706: 127V a.c. Input (will operate at 110-130V a.c.)
230V or 115V nominal outputs

CURRENT RATING

K701: 200mA max.

(internal thermister trip current)

K706: 400mA max.

(internal thermister trip current)

MAXIMUM LOAD

20VA

No load voltage < 275V

TERMINAL CAPACITIES

Each terminal will accommodate 1 x 4mm² or 2 x 2.5mm² solid conductors

PHYSICAL

AMBIENT OPERATING TEMPERATURE

-5°C to +40°C

IP RATING

IP41 (In Zone 2 if fixed where direct spray from showers is unlikely)

MAX. INSTALLATION ALTITUDE

2000 metres

FEATURES

- Top access terminal screws make wiring quicker and easier
- Automatic primary supply switching on insertion of plug
- Choice of 230V or 115V output socket positions
- Safety interlocked shutters to prevent insertion of two plugs simultaneously
- Only one size of screwdriver required for installation
- Front plate fixing screws retained on rear case moulding
- Integral over current device to protect transformer
- Suitable for use with electric toothbrush chargers

Installation

Shaver/Toothbrush supply unit should be wall mounted.

13A Connection Units, 20A Switches and Flex Outlets

Standards and approvals

All Connection Units comply with BS 1363-4:1995.

All 20A DP Switches comply with BS EN 60669-1:1999.

Flex Outlet complies with BS EN 60670-22:2006.

Fuses comply with BS 1362:1973.

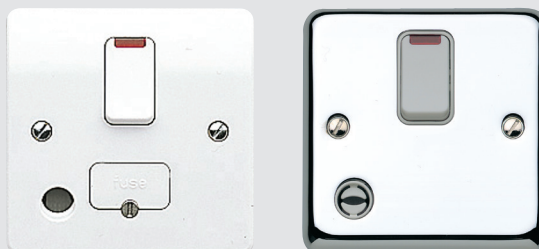

TECHNICAL SPECIFICATION

ELECTRICAL

VOLTAGE RATING

250V a.c.

CURRENT RATING

Connection Units: 13A

DP switches: 20A

Flex outlets: 20A

TERMINAL CAPACITY

Supply terminal:

2 x 6mm² stranded

2 x 4mm²

3 x 2.5mm²

Load terminals:

2 x 6mm² stranded

2 x 4mm²

3 x 2.5mm²

CORD GRIP CAPACITY

Connection units:

min: 2 core, 0.5mm

max: 3 core, 1.5mm

20A DP switches & flex outlet plate:

min: 3 core, 1.5mm

max: 3 core, 2.5mm

PHYSICAL

AMBIENT OPERATING TEMPERATURE

-5°C to +40°C

IP RATING

With flex outlet: IP2XD

Without flex outlet: IP4X

MAX. INSTALLATION ALTITUDE

2000 metres

Description

A range of 13A fused connection units and 20A DP switches designed for the connection of refrigerators, water heaters, central heating boilers and other fixed appliances.

The ranges are designed for ease of installation and have the advantageous design features of the MK range of wiring devices.

Neon indicators

Products are available with Neon indicators included in the rockers of the switched connection units. In the case of unswitched units, they are positioned centrally and uppermost on the face plate. Neon indicators are integrally wired into the product and do not require separate connection when installing. The design gives 175° visibility in the horizontal and vertical planes.

Fuse carriers

These are captive and are opened by a fast acting, screwdriver operated worm drive for ease of replacement. A tamper-proof version is also available.

Fuse carriers can be locked open using a padlock, List No. K2000.

Flex outlets

Bottom outlet types are supplied with blanking plug allowing use where the bottom outlet is not required.

The products are equipped with very strong, push-fit nylon cord grips making installation safe, quick and easy.

Flex outlet plate

An unfused flex outlet with cord grip and 3 pairs of terminals.

Installation

Wiring

Products must be installed in accordance with current IET Regulations.

Changing Fuses

1. Unscrew the fuse carrier screw to partially eject the carrier.
2. Carefully lever the carrier out further to remove the fuse.
Note: The carrier does not come fully out.
3. Always replace with a BS 1362 type fuse (as used in 13A plugs) of the correct rating.
4. Consistent fuse blowing could mean a faulty appliance. If in doubt, consult a qualified electrician.
5. Push carrier back until engaging with jacking screw. Screw the carrier down until flush with surface of the plate. Do not over tighten the screw.

13A Connection Units, 20A Switches and Flex Outlets

FEATURES

- Optional indicators in the switch rockers with 175° visibility in the horizontal and vertical planes
- Worm-drive operated fuse carriers for additional security (tamper-proof version available)
- Fuse carrier lockable in open position
- All supply and load cables can be cut and stripped to the same length
- Integrally wired Neon indicators save installation time
- Push-fit cord grips, for safer, quicker installation
- Angled, top mounted terminal screws simplify wiring
- Moulded 'on' indicator flash on switches cannot rub off – totally safe
- Captive fuse carrier
- Additional electrical safety from DP Switch, neutral 'make first', 'break last' feature
- Secure cable and flexible cord connection
- All terminal and fixing screws operated by one-size (4mm) screwdriver
- Backed out and captive terminal screws

Note: These switches are not recommended for switching large banks of PCs

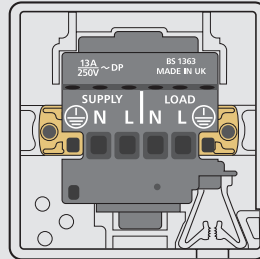

Supply and load cable cords cut and stripped to same length



Blanking plug for bottom outlet

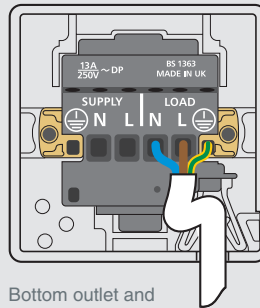

Bottom outlet and cord grip

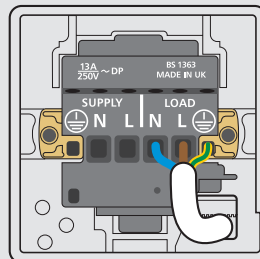
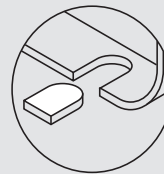

Front outlet cord grip



Lockable fuse carrier

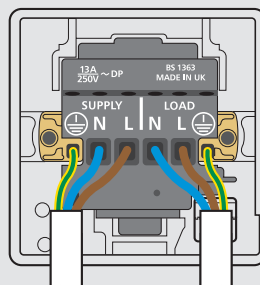

Supply and non flexible load cables

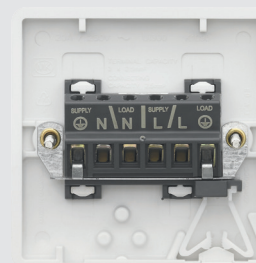

K1090WHI Flex Outlet

20A Key Operated Fire Alarm Isolator Switch

TECHNICAL SPECIFICATION

ELECTRICAL

VOLTAGE RATING
250V a.c.

CURRENT RATING
20A

TERMINAL CAPACITIES
Live, Neutral & Earth
3 x 2.5mm²
3 x 4mm²
2 x 6mm²

PHYSICAL

AMBIENT OPERATING TEMPERATURE
-5°C to +40°C

IP RATING
IP2XD

MAX. INSTALLATION ALTITUDE
2000 metres



Description

The isolators comply with BS 60669-2-4:2005

The Isolator is intended for use with building alarm systems that are required to comply with BS 5839 Part 1.

FEATURES

- The built in lock ensures power cannot be provided without the key being operated, making it safe to carry out maintenance to fire alarms
- Printed terminal markings on grey rear of the switch moulding for clearer identification
- Double Pole switching
- Only one size of screwdriver required for installation

Note: The lock fitted to these isolators is universal for all MK 20A Isolators in the range i.e. a common key profile.

However, the keys are different to those used on all other MK Key Operated Switched Products, for added security.

High Current Switches and Cooker Control Units

Standards and approvals

All DP switches in the range comply with BS EN 60669-1:1999.

All Cooker Control Units in the range comply with BS 4177:1992.

Cooker Connection Unit comply with BS EN 60670-22:2006

TECHNICAL SPECIFICATION

ELECTRICAL

VOLTAGE RATING
250V a.c.

CURRENT RATING
32A Switch
45A Cooker Control Unit
45A Cooker Connection Unit
50A Switch (Resistive Load)

SWITCH

3mm contact gap
Double pole operation –
except socket switch on Cooker Control Units

TERMINAL CAPACITY 50A SWITCHES

Cooker Control Units, and Cooker Connection Units:
4 x 4mm²
3 x 6mm²
1 x 10mm²
1 x 16mm²

TERMINAL CAPACITY, 32A SWITCH

3 x 2.5mm²
2 x 4mm²
1 x 6mm²

PHYSICAL

AMBIENT OPERATING TEMPERATURE
-5°C to +40°C

IP RATING

IP2XD
Cooker Control Units

IP4X

32A Switch, 50A Switch, Cooker Connection Unit

MAX. INSTALLATION ALTITUDE

2000 metres

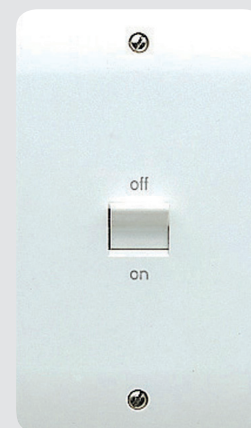

Description

A range of switches and cooker control units suitable for the switching of all domestic, commercial and industrial appliances where higher current ratings are required, i.e. cookers, heaters, units etc. Metal units are particularly suitable for refurbishment projects.

FEATURES

- Positive switch action
- Positive double pole switching
- Toggle action switches
- Metal front plates available
- Replaceable neon indicators
- Wide product choice

Note: These switches are not recommended for switching large banks of PCs

Plateswitches

Standards and approvals

All MK plateswitches comply with BS EN 60669-1:1999.

TECHNICAL SPECIFICATION

ELECTRICAL

VOLTAGE RATING
250V a.c.

CURRENT RATING

10A – no derating when used on fluorescent or inductive loads

20A – no derating when used on fluorescent or inductive loads

Push / Retractive switch types are not intended for fluorescent loads.

TERMINAL CAPACITY

4 x 1mm²
4 x 1.5mm²
3 x 2.5mm²
2 x 4mm²
1 x 6mm²

CONTACT GAP

3mm switch contact gap

PHYSICAL

AMBIENT OPERATING TEMPERATURE
-5°C to +40°C

IP RATING
IP2XD

MAX. INSTALLATION ALTITUDE
2000 metres

Operational testing (all plateswitches): tested to 100,000 operations for mechanical life tested to 40,000 operations at 10A rating tested to 10,000 operations at 20A rating.

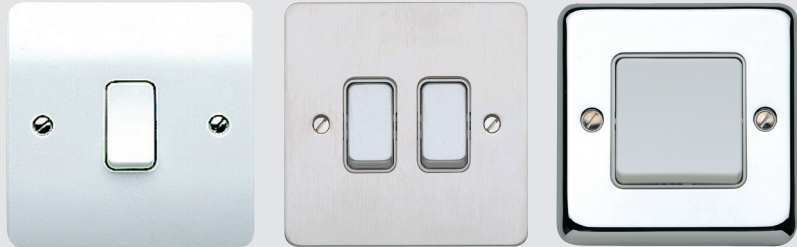

Description

MK plateswitches are designed to blend in with the decor, whilst complementing a wide range of other MK wiring devices. They are designed for easy installation in plasterdepth boxes and are suitable for controlling lighting circuits in domestic, commercial and industrial applications.

Neon locator

A textured, polycarbonate moulding allowing the glow of the neon to be seen at almost any angle. Designed to complement the Logic Plus 1, 2, or 3 gang plateswitches.

It is easy to install in existing locations. For 3 gang applications using a 25mm deep box simplifies wiring.

FEATURES

- Two way switches can be wired as one or two way
- Matching Grid switches available in 10 or 20A ratings
- 3mm switch contact gap
- Positive switch action
- Top access, backed out and captive terminal screws
- Neon locator available making switch easy to find in darkened rooms (Logic Plus™ only)



Plateswitches

Wiring diagrams

One-way switching

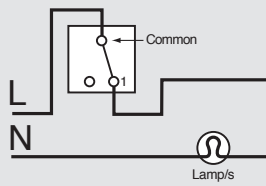

Two-way switching – 2 wire control

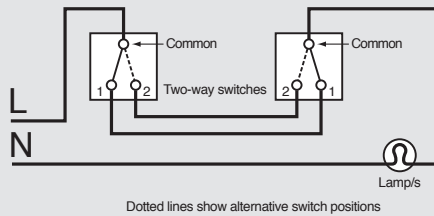

Two-way switching plus intermediate switching – 2 wire control

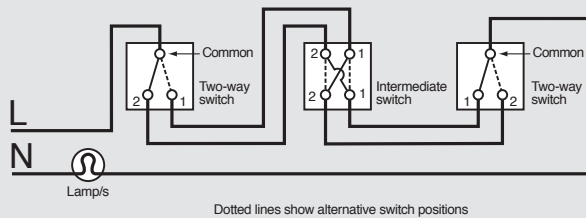

Two-way switching – 3 wire control

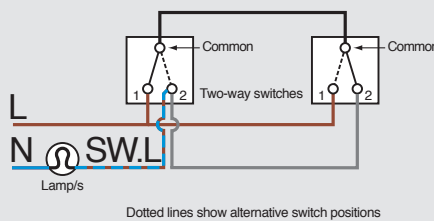

Two-way switching plus intermediate switching – 3 wire control

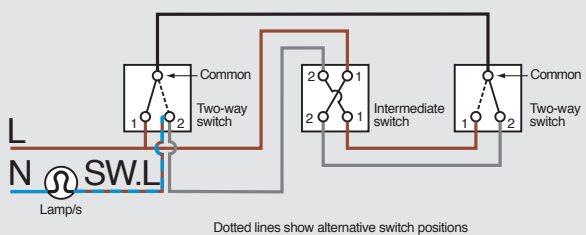

N.B. Terminal positions may alter. The above diagrams are to show wiring layout.

Dimmer Switches

Standards and approvals

All CE marked Logic Plus™ dimmer switches comply with the EC Low Voltage

Directive: 73/23/EEC, Electromagnetic Compatibility Directive 89/336/EEC

They also comply with BS EN 60669-2-1 and IEC 60669-2-1 (LED Intelligent Dimmer only)

*Non-UK dimmer switches see note below

TECHNICAL SPECIFICATION

ELECTRICAL

MAINS SUPPLY VOLTAGE

230V a.c. (Nominal)
220V a.c. (Nominal, Non-UK)
220V a.c. to 240V a.c. (For LED Intelligent Dimmer)

MAINS SUPPLY VOLTAGE RANGE

216V a.c. to 253V a.c.
200V a.c. to 250V a.c.
198V a.c. to 264V a.c. (For LED Intelligent Dimmer)

MAINS SUPPLY FREQUENCY

50Hz ±3Hz
60Hz ±3Hz

TYPE OF LOADS

STANDARD DIMMERS

Fused GLS Tungsten Filament lamps only to BS EN 60064:1996 and BS EN 60432-1:2000, rated at 230/240V

INTELLIGENT DIMMERS AND LED INTELLIGENT DIMMERS:

Fused GLS Tungsten Filament lamps to BS EN 60064:1996 and BS EN 60432-1,2 rated at 230/240V. Dimmable wire wound or electronic Low Voltage Transformers of good quality. Can also be used with good quality mains voltage halogen lamps incorporating GU10 bases. Please check with lamp manufacturer to determine suitability.

Note: Transformer must be suitable for dimming using phase delay (leading edge) and NOT only phase cut (trailing edge) type of dimmers.

Warning: These dimmer switches are not suitable for use with Fluorescent Lamps or Energy Saving Lamps.

PHYSICAL

AMBIENT OPERATING TEMPERATURE

0°C to +40°C

IP RATING

IP2XD

MAX. INSTALLATION ALTITUDE

2000 metres



Description

MK dimmer switches can fall into one of four categories

- 1) Standard Dimmer Switches
- 2) Intelligent Dimmer Switches
- 3) Non-UK Dimmer Switches
- 4) LED Intelligent Dimmer Switches

Standard Dimmer Switches

Dimmer Switches belonging to this category employ simpler electronic circuitry and the CE marked products make use of thermal switches to conform to the very stringent requirements of the Standard BS EN 60669-2-1, for overload protection. They are only suitable for use with normal tungsten filament lamps, conforming to BS EN 60064:1996 and BS EN 60432-1 Standards and do not have any added features, e.g. soft start, ability to control dimmable transformers for low voltage, etc.

Standard Dimmer Switches are not suitable for use with transformers for Low Voltage Lighting or Fluorescent Loads, including Energy Saving Lamps.

Intelligent and LED Intelligent Dimmer Switches

Dimmer Switches belonging to this category, employ the latest, state of the art, micro-controller based electronic circuitry and use current sensing to compute the load conditions. These products show progressive reaction to overload conditions, depending on the extent of overload as shown in the table below. List numbers belonging to this category are identified by the suffix letters LV, e.g. K1501 WHI LV. All MK Intelligent Dimmer Switches employ one pole change over switches to facilitate two way switching.

MK Intelligent and LED Intelligent Dimmer Switches are not suitable for use with Fluorescent Loads, including Energy Saving Lamps.

*Non-UK Dimmer Switches

Dimmer switches belonging to this category only conform to the relevant parts of BS EN 60669-2-1. Loads suitable for use with standard dimmer switches above are also suitable for use with this category of dimmer switch.

Only one Dimmer Switch can be used in a two-way switching circuit.

Minimum Brightness Adjustment for LED Intelligent Dimmers

The light output of some LED lamps may appear to be too dim or invisible when the dimmer knob is at the minimum dim level. Follow the steps below to adjust the minimum brightness level. This feature is primarily for adjusting the minimum brightness level of the LED lamp although it can be used for other load types.

For a double gang dimmer, the light level of each gang has to be adjusted separately.

Step 1 – Access To Programming Mode

1. Push the dimmer knob so that it is in OFF state.
2. Set the dimmer knob to minimum level.

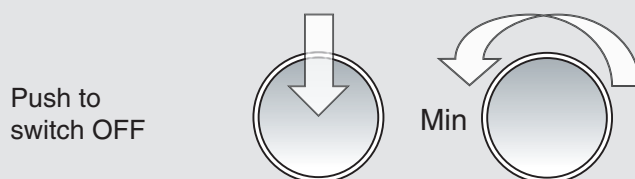

3. Turn on the dimmer and immediately rotate the knob 3 times in full rotary span within 5 seconds.

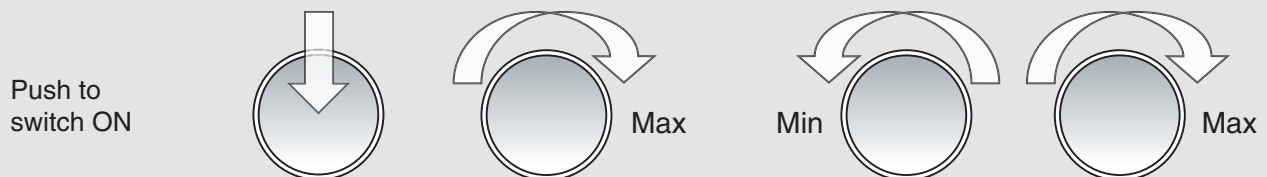

NOTE: Wait for 3 seconds, the lamp will then dim to minimum before automatically brightening to about 30% level. Turning/pushing the dimmer knob before the end of automatic brightening will end access to programming mode

4. Dimmer enters programming mode.

Step 2 – Adjust Brightness Level and Exit Programming Mode

5. Rotate the dimmer knob anticlockwise to adjust the lamp to the desired brightness level.

NOTE: Some LED lamps may not work properly if the brightness level is set too low thus it is recommended to keep the brightness level of the lamp at a visible level. The dimmer will exit programming mode automatically without saving the new setting if there is no dimmer knob movement for 15 seconds. The dimmer will restore its factory default light level.



6. Confirm the new setting and exit programming mode by turning OFF the dimmer.



Step 3 – Success indication (Programming Complete)

7. The next time the dimmer is turned on the lamp will automatically brighten to the maximum level before dimming to the brightness level corresponds to the knob level.

Dimmer Switches

FEATURES

Intelligent and LED Intelligent Dimmer Switches

incorporate the following advanced features

- Suitable for dimming Low Voltage Halogen lamps via good quality, fully dimmable electronic or wire-wound transformers. In addition, LED Intelligent dimmer switches are suitable for dimmable LED bulbs for incandescent replacement.
- Can be used with good quality mains voltage halogen lamps incorporating GU10 bases. Please check with lamp manufacturer to determine suitability
- Load current sensing:
These dimmers continuously monitor the load current to help protect against overheating in wire wound transformers and to prevent overloading of the dimmer for long term reliability

- Soft Start, which gradually increases the light output from the load over 1 to 3 seconds after switch on. The Soft Start feature is also particularly beneficial when used to dim Mains Voltage Tungsten Halogen lamps which inherently have a very high inrush current at switch on

Standard Dimmer Switches

- Suitable only for use with fused GLS Tungsten Filament lamps to BS EN 60064 and BS EN 60432-1
- One way dimmer switches incorporate manual soft start
- Incorporate thermal switches for protection against overload

LOAD TYPES AND LOADINGS

DIMMER SERIES	DIMMER SIZE (1 GANG)	RATING			MAX NO. OF TRANSFORMERS AND LEDS (TOTAL RATING MUST NOT EXCEED MAX. VA RATING OF DIMMER)	
		GLS AND MAINS VOLTAGE HALOGEN	ELECTRONIC OR WIRE WOUND LV TRANSFORMERS	LED	TRANSFORMERS	LEDS
INTELLIGENT DIMMER SWITCHES	single dimmer	40-300W	40-240W/VA	-	4	-
	double dimmer	2 x 40-300W	2 x 40-240W/VA	-	4 per dimmer	-
	single dimmer	60-500W	60-400W/VA	-	5	-
STANDARD DIMMER SWITCHES	single dimmer	40-250W	-	-	-	-
	double dimmer	2 x 40-250W	-	-	-	-
	single dimmer	65-450W	-	-	-	-
LED INTELLIGENT DIMMER SWITCHES	single dimmer	40-300W	40-240W/VA	4-70W	4	10
	double dimmer	2 x 40-300W	2 x 40-240W/VA	2 x 4-70W	4 per dimmer	10 per dimmer

Do not connect more than the maximum number of transformers stated for each dimmer.

One-way switching

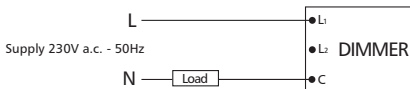

Two-way switching (only one dimmer can be used)

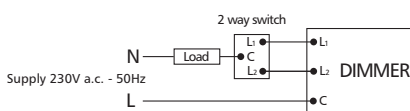

Wires must be connected to the correct dimmer terminals.
DO NOT connect earth to dimmer.

OVERLOAD MANAGEMENT

60-500W CIRCUIT	40-300W CIRCUIT	LED INTELLIGENT DIMMER
60-500W nominal	40-300W nominal	40-300W nominal
60-625W function without dimming	40-375W function without dimming	40-375W function without dimming
> 625-750W dim to 68V±8V r.m.s.	> 375-500W dim to 68V±8V r.m.s.	> 375-600W dim to minimum level
> 750W switch off	> 500W switch off	> 600W switch off

Please note the dimmer may be substituted for any Two-Way switches.

Euro and LJU6C Data Frontplates

Standards and approvals

BS 5733:2010

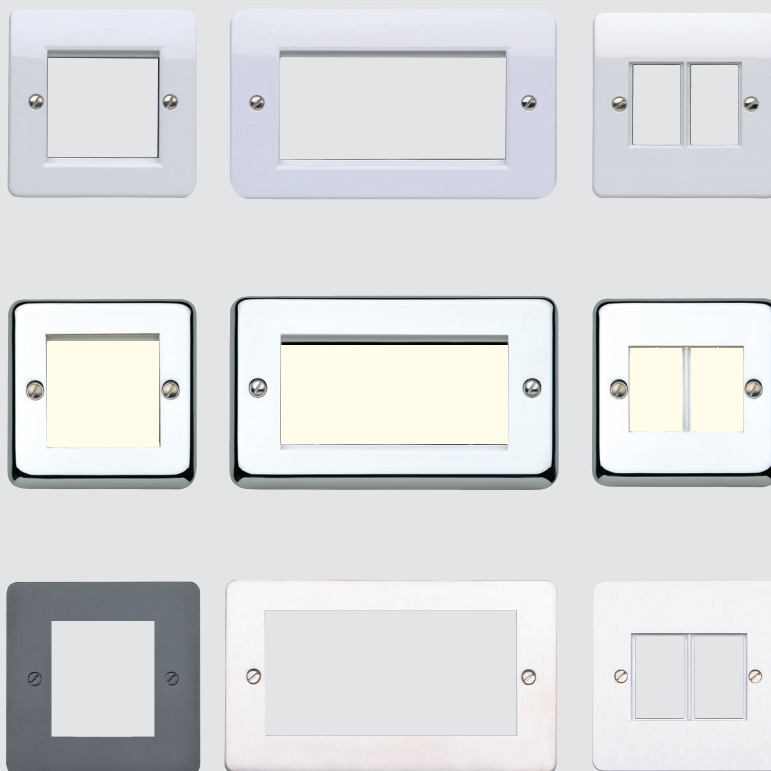

Description

Frontplates used for mounting snapfit modules.

FEATURES

- 1G, 2G and 3G Euro frontplates
- 1G LJU6C Frontplate
- Accept industry standard (Euro) and LJU6C snapfit modules
- 1G Euro frontplate accepts 2 Euro modules, (50 x 50mm aperture)
- 2G Euro frontplate accepts 4 Euro modules, (100 x 50mm aperture)
- 3G Euro frontplate accepts 6 Euro Modules, (150x50mm aperture)
- 1G LJU6C frontplate accepts two LJU6C modules (27 x 37mm aperture)
- 1/2 , 1 and 2 module Euro Blanks available
- 1 module LJU6C Blank available

Power Modules

Standards and approvals

K5830: BS 1363 Part 2:1995

K5831: IEC 60884-1:2006

K5832: SASO 2204:2003

K5833: BS 546:1950

K5834: French National Standard NF C 61-314

Description

A range of euro modules designed to provide a variety of power options.

TECHNICAL SPECIFICATION						
13A UK	5A UK	16A GERMAN	16A FRENCH/BELGIAN	15A AMERICAN	2A USB CHARGING MODULE	
ELECTRICAL	ELECTRICAL	ELECTRICAL	ELECTRICAL	ELECTRICAL	ELECTRICAL	OUTPUT
VOLTAGE RATING 250V a.c.	VOLTAGE RATING 250V a.c.	VOLTAGE RATING 250V a.c.	VOLTAGE RATING 250V a.c.	VOLTAGE RATING 127V a.c.	INPUT	VOLTAGE RATING 2 x 5V d.c.
CURRENT RATING 13A	CURRENT RATING 5A	CURRENT RATING 16A	CURRENT RATING 16A	CURRENT RATING 15A	VOLTAGE RATING 220-240V a.c.	FREQUENCY 50-60Hz
TERMINAL CAPACITY Live, neutral & earth 3 x 2.5mm ² 3 x 4mm ² 2 x 6mm ² (stranded)	TERMINAL CAPACITY Live, neutral & earth 3 x 2.5mm ² 3 x 4mm ² 2 x 6mm ² (stranded)	TERMINAL CAPACITY Live, neutral & earth 4 x 1.5mm ² 2 x 2.5mm ² 1 x 4mm ²	TERMINAL CAPACITY Live, neutral & earth 3 x 2.5mm ² 3 x 4mm ² 1 x 6mm ²	TERMINAL CAPACITY Live, neutral & earth 3 x 2.5mm ² 3 x 4mm ² 1 x 6mm ² (stranded)	TERMINAL CAPACITY Live & neutral 3 x 2.5mm ²	MAX CURRENT Combined total of 2A
PHYSICAL	PHYSICAL	PHYSICAL	PHYSICAL	PHYSICAL	PHYSICAL	CHARGING SOCKETS USB 2.0 Type A, USB 3.0
AMBIENT OPERATING TEMPERATURE -5°C to +40°C	AMBIENT OPERATING TEMPERATURE -5°C to +40°C	AMBIENT OPERATING TEMPERATURE -5°C to +40°C	AMBIENT OPERATING TEMPERATURE -5°C to +40°C	AMBIENT OPERATING TEMPERATURE -5°C to +40°C	AMBIENT OPERATING TEMPERATURE 0°C to +40°C	
IP RATING IP2XD	IP RATING IP2XD	IP RATING IP2XD	IP RATING IP2XD	IP RATING IP2XD	IP RATING IP3xC	
MAX. INSTALLATION ALTITUDE 2000 metres	MAX. INSTALLATION ALTITUDE 2000 metres	MAX. INSTALLATION ALTITUDE 2000 metres	MAX. INSTALLATION ALTITUDE 2000 metres	MAX. INSTALLATION ALTITUDE 2000 metres	MAX. INSTALLATION ALTITUDE 2000 metres	

Dimensions (mm)

13A UK

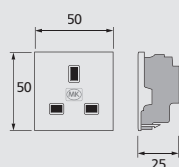

K5830

BOX TYPES
MINIMUM
35MM
EXTRA WIRING SPACE
46MM

5A UK

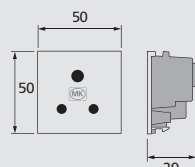

K5833

BOX TYPES
MINIMUM
35MM
EXTRA WIRING SPACE
46MM

16A German

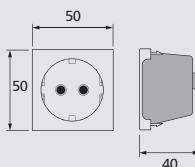

K5831

BOX TYPES
MINIMUM
46MM

16A French/ Belgian

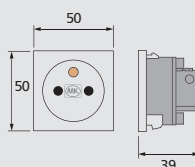

K5834

BOX TYPES
MINIMUM
46MM

15A American

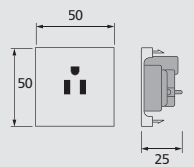

K5832

BOX TYPES
MINIMUM
35MM
EXTRA WIRING SPACE
46MM

2A USB Charging Module

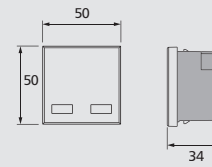

K5837

MK EURO FRONT PLATE THICKNESS	BOX TYPES
> 7mm	Min 35mm
< 7mm	Min 46mm

Wiring Devices Technical

RJ45 Data Outlets

Standards and approvals

ISO/IEC 11801

EN 50173

TIA 568

EN 41003



Installation

- Maximum cable length 90m.
- Cable bend radii, 40mm during installation, 20mm after installation.
- Maximum pull force 8.7kg.
- Do not over tighten cable ties.
- Do not unwind the twists in the wire pairs by more than 13mm max.

Description

Suitable for use in all LJU6C and Euro frontplates, available in the Logic Plus range, Cat 5e and Cat 6 modules suitable for use in structured cabling distribution systems.

Installation details and wiring diagram illustrations

TIA WIRING SCHEME COLOUR CODES		
PIN NO.	568A	568B
1	WHITE / green	WHITE / orange
2	GREEN / white	ORANGE / white
3	WHITE / orange	WHITE / green
4	BLUE / white	BLUE / white
5	WHITE / blue	WHITE / blue
6	ORANGE / white	GREEN / white
7	WHITE / brown	WHITE / brown
8	BROWN / white	BROWN / white

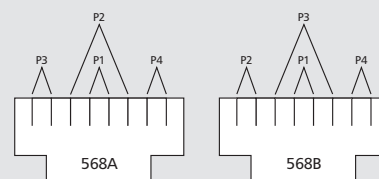

Pair 1 – BLUE/white & WHITE/blue
 Pair 2 – ORANGE/white & WHITE/orange
 Pair 3 – GREEN/white & WHITE/green
 Pair 4 – BROWN/white & WHITE/brown

Euro and LJU6C modules are to be wired as follows

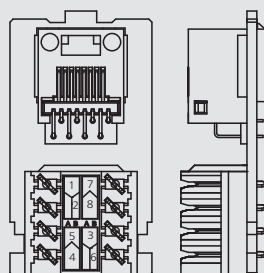

RJ45 Cat.5e Euro K5845

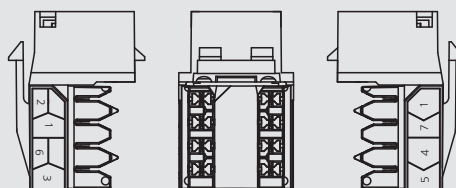

RJ45 Cat.5e Euro - Angled K5844

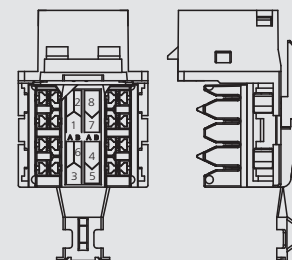

RJ45 Cat.6 Screened K5746S - LJU6C, K5846S - Euro

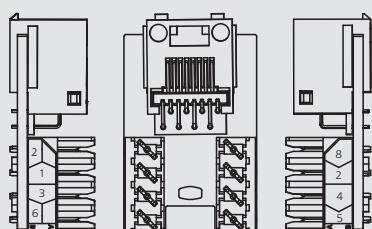

RJ45 Cat.5e LJU6C K5745

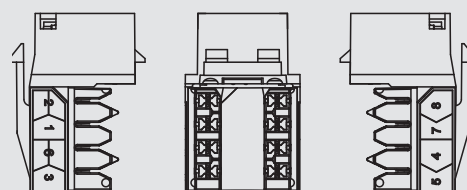

RJ45 Cat.6 Euro - Angled K5746 - LJU6C K5846 - Euro, K5864 - Euro Angled

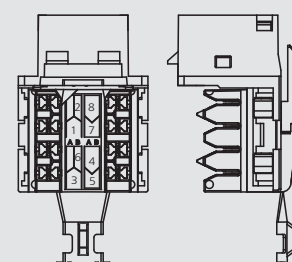

RJ45 Cat.5e Screened K5845S - Euro



Technical Hotline
+44 (0)1268 563720

Wiring Devices Technical

Telephone, RJ11/12, BNC Data and Blank Modules

Standards and approvals

Telephone sockets K5820 and K5821 comply with the following:

BS 6312: 2.2

Data sockets K5801, BS 5733: 2010 (where applicable).

K5887 complies with FCC68 and EN 41003.



TECHNICAL SPECIFICATION

ELECTRICAL

CABLE TYPES

Telephone: CW1311, CW1293, CW1308, CW1316

NO. OF CABLES PER TERMINATION

Telephone: 2

RJ11/12: 1

BNC

50 Ohms impedance cable – RG58, RG141, URM43 Belden 9907

FREQUENCY RANGE

BNC connector: 0 to 4GHz

IMPEDANCE

BNC Connector: 50. nominal

TERMINATION TYPE

Telephone module – IDC

BNC module – Crimped connection

PHYSICAL

AMBIENT OPERATING TEMPERATURE

-5°C to +40°C

IP RATING

IP2XD – K5820, K5821, K5801 and K5787.

IP4X – K180, K188, K186 and K170

MAX. INSTALLATION ALTITUDE

2000 metres

Description

A range of telephone, data and blank modules to fit Euro and LJ6UC front plates. BNC Euro modules with a 50Ohm crimp connector suitable for use with RG58, URM43, URM76 and Belden 9907 type co-axial cables are also available.

Installation (Telephone socket modules)

Product performance, systems compatibility

Master Sockets: For use as the first socket outlet on a direct exchange. They contain the required surge protector (for line protection against electrical surges) and ringing capacitor.

Secondary Sockets: for use as extension sockets when connected on the same line as a Master Socket.

Installation tools required IDC Connectors (telephone & RJ45 outlets)

MK insertion tool List No. 400NAT.

Wire pull-out force: 10.5 Newtons when installed correctly.

Wiring regulation restrictions

Domestic Installations: The total REN (Ring Equivalent Number) value of all telephone equipment connected on a line must not exceed 4.

FEATURES

- Meet all relevant BS and cabling standards
- Interchangeable modules clip into frontplates
- Front fixing facilitates easy exchange of modules
- Part of a complete range of products for telephone and data processing requirements

Telephone sockets

- Quick, simple and reliable IDC connectors
- Can be specified for all applications

Data sockets

- Latest specification for high performance systems
- Wide range of data connectors available

For information on TV Satellite and FM Modules see pages 471-473

Wiring Devices Technical

Telephone, RJ11/12, BNC Data and Blank Modules

Telephone Wiring Scheme

- 1 GREEN / white
- 2 BLUE / white
- 3 ORANGE / white
- 4 WHITE / orange
- 5 WHITE / blue
- 6 WHITE / green

Note: Main wire colour is shown in capitals

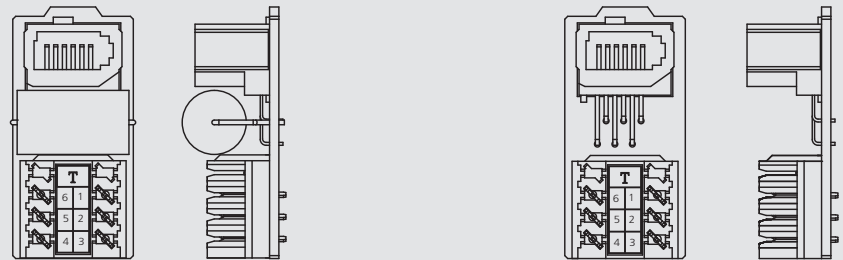

K5820

K5821

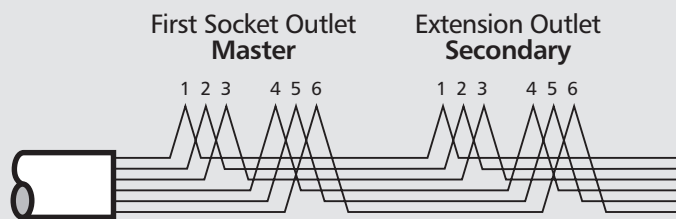

RJ11/12 Wiring Scheme

PIN NO.	STRIPPED COLOUR WIRE	SOLID COLOUR WIRE
1	WHITE / green	WHITE
2	WHITE / orange	BLACK
3	BLUE / white	RED
4	WHITE / blue	GREEN
5	ORANGE / white	YELLOW
6	GREEN / white	BLUE

Note: Main wire colour is shown in capitals

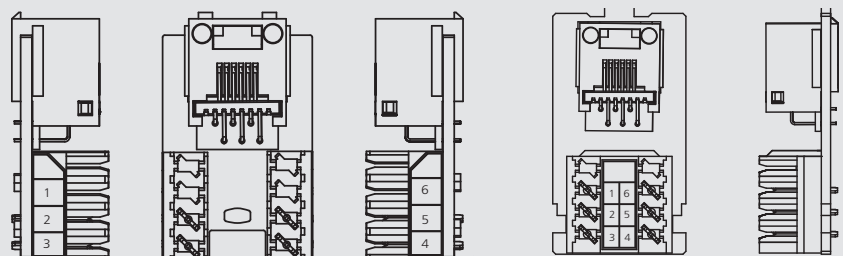

K5787

K5887

Telephone, TV/FM and Satellite Socket Outlets

Standards and approvals

Telephone and TV sockets comply with the following:

Telephone sockets K422 and K427

BS 6312: 2.2, BS 5733:2010 (where applicable).

K4817: BS 5733:2010 (where applicable) and FCC68.

TV sockets

BS 3041 Part 2:1977 / IEC 169-2:1977,
BS 5733:2010 (where applicable) and IEC65,
clauses 10.1, 10.3.

Satellite TV sockets

BS 5733:2010 (where applicable).



Description

A part of the very wide range of products to meet the latest technical requirements and the standards applicable to modern technology in the installation of telephone and television equipment. The master and secondary telephone sockets K422 and K427 comply with relevant approvals for direct and indirect connections between a termination point of a public telecommunications system and any piece of approved telecommunications apparatus. For applications requiring twin or dual telephone outlets, refer to the Modular Data section, pages 46-48.

Telephone and TV sockets fit into plaster depth boxes (except for RJ11).

The F-type Satellite Socket may be used for connection of CATV, MATV and satellite TV installations.

TECHNICAL SPECIFICATION

ELECTRICAL

TELEPHONE SOCKETS, CABLE SPECIFICATION
CW1311, CW1293, CW1308, CW1316

NO. OF CABLES PER TERMINATION
2

RE-USABILITY

>9 reterminations (should not be reterminated with smaller diameter wire)

TV SOCKETS

Cable specification: CT100 or equivalent Any standard

LOW-LOSS TV CO-AXIAL CABLE:

Outside 4-8mm diameter, inner conductor 0.5-2mm diameter

INSERTION LOSS

Insertion loss data available on request

'F' TYPE SATELLITE SOCKET (K3525), CABLE SPECIFICATION

Co-axial cable: inner core diameter – 0.5-1.2mm

RJ11 (K4817), CABLE SPECIFICATION

Capable of taking 0.08 to 0.65mm² solid or stranded cable

PHYSICAL

AMBIENT OPERATING TEMPERATURE

--5°C to +40°C

IP RATING

IP2XD

MAX. INSTALLATION ALTITUDE

2000 metres

FEATURES

- Single screw termination on TV outlets
- Protected, fully enclosed PCBs
- Meet all relevant BS requirements
- Quick, simple and reliable terminal connection
- IDC connectors on telephone outlets
- Part of a complete range of products for telephone, television and data processing requirements
- Angled connector on TV outlets
- Sockets fit in plaster depth boxes (except K4817)

Telephone, TV/FM and Satellite Socket Outlets

Installation (Telephone sockets)

Product performance, systems compatibility

Master Sockets: for use as the first socket outlet on a direct exchange or PABX line. They contain surge protector (for line protection against electrical surges) and ringing capacitor.

Secondary Sockets

For use as extension sockets when connected on the same line as a Master Socket.

Installation tools required

MK IDC insertion tool List No. 400NAT (not supplied with product).

Wiring regulation restrictions

Domestic installations

Any number of MK sockets may be installed thereafter, with a total REN (Ring Equivalent Number) value of all telephone equipment connected on a line not exceeding 4.

Telephone Wiring Scheme

- 1 GREEN / white
- 2 BLUE / white
- 3 ORANGE / white
- 4 WHITE / orange
- 5 WHITE / blue
- 6 WHITE / green

Note: Main wire colour is shown in capitals

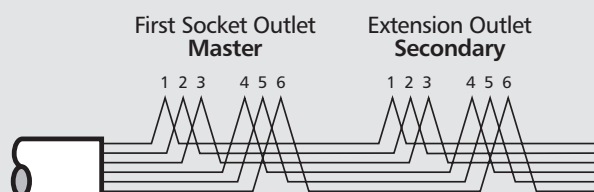
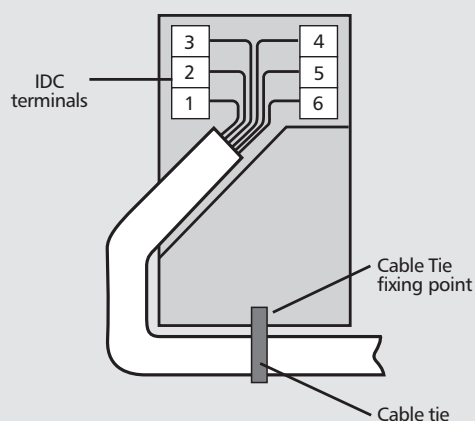

Digital TV and Telephone Outlets (Logic Plus and Modular Datacoms)

Installation (TV sockets)

Product performance, systems compatibility

Isolated Outlets are intended for use where safety isolation (rated at 2000V ac) is required to provide protection against faults occurring within any mains powered product used on different parts of the distribution system. They are not suitable for use in systems where DC signals are passed through the socket, (e.g. where masthead/headend equipment is controlled by receiver/decoder equipment).

Diplexer Outlets are used in distribution systems where both TV and FM band signals are combined on a single aerial downlead. The filtering in the diplexer separates the appropriate signals and feeds them through to the relevant output connection port.

Cable Routing and Use of Cable Clamp

Sharp bends in the cable must be avoided during installation. The single TV/FM socket is fitted with a cable clamp that can be fixed on either side of the termination position to facilitate this.

When tightening the screening braid clamps ensure that the cable is firmly gripped and that the inner insulation is not squashed flat beyond a slight oval shape.

Safety Information

TV outlets or modules must not be installed in the same enclosure as equipment rated in excess of 50V, (e.g. mains rated 13A sockets or switches).

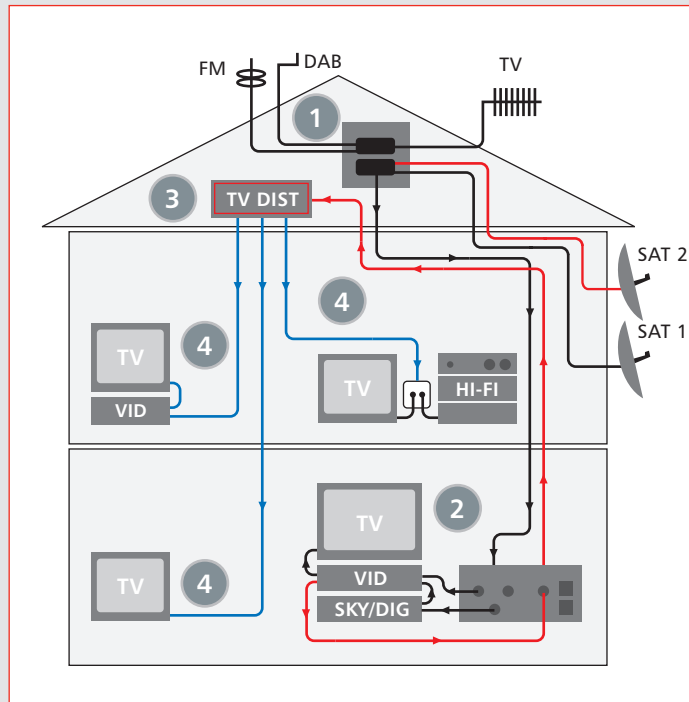

Method of installation of TV and FM aerial connection by using MK co-axial socket outlet and only one download.

Conventional distribution system for TV and FM signals using a single aerial download.

- 1 The signals from the TV and FM aerials and the satellite dish are combined together using two products. The first combines the TV and FM signals and the second adds the Sky signal to the TV/FM signal and provides a DC control path to power the LNB unit on the satellite dish. (These products are not supplied by MK).

The single aerial down lead feeds into the triplexer (black lines in wiring diagram).

- 2 The separated satellite signal is then fed to the decoder. The decoded satellite signal is then fed into the VCR along with the TV signal from the Triplexer. The output signal from the VCR then feeds into the TV and also back to the single outlet and onto the distribution amplifier (black lines in wiring diagram).
- 3 The single cable back-feed then feeds back to the input of a multi way distribution amplifier, (typically located in the loft or garage) (red lines in wiring diagram).
- 4 Each individual output from the distribution amplifier is then fed to the individual rooms in the house to a standard TV (single or diplexer) outlet to which the TV/VCR and/or Hi-Fi can be connected (blue lines in wiring diagram).

Digital TV, Radio and Telephone Outlets

Standards and approvals

All Logic Plus TV Outlets comply with BS 5733 and BS EN 50083 where applicable.

Also IEC 169-2, BS EN 60169-24 and BS 6312 Part 2

Modular products are Euro compatible.

TECHNICAL SPECIFICATION

SINGLE OUTLETS

TV/FM IEC Male or Female DC-950MHz
SATF-Type DC-1.75GHz

DIPLEXER AND TRIPLEXER PRODUCTS

TV

Diplexer:
5-65MHz
470-862MHz

Triplexer:

5-65MHz
470-862MHz

FM

Diplexer: 87.5-108MHz
Triplexer: 87.5-108MHz

SAT

Diplexer: n/a
Triplexer: 950-2300MHz

TV/FM/DAB/SAT PRODUCTS FOR DIGITAL RADIO

TV

Diplexer:
5-65MHz
470-862MHz

Triplexer:

5-65MHz
470-862MHz

FM/DAB

Diplexer: 87.5-230MHz
Triplexer: 87.5-230MHz

SAT OR SAT1

Diplexer: n/a
Triplexer: 950-2300MHz

SAT2

Diplexer: n/a
Triplexer: 5-2300MHz



Description

There are two ranges of diplexer and triplexer products, an established range suitable for VHF TV, and a range suitable for digital radio (DAB).

Diplexer modules are for connecting to a single co-axial aerial down lead carrying combined TV and FM signals. The filtering in the diplexer splits out the appropriate signal and feeds it to the relevant output connection.

A DC control path is provided in the TV signal path through the diplexer.

Triplexer modules are for connecting to a single co-axial aerial down lead carrying combined TV, FM and SAT signals. The filtering in the triplexer splits out the appropriate signal and feeds it to the relevant output connection.

A DC control path is provided in the SAT signal path through the triplexer.

The quad outlet contains a triplexer together with a separate satellite output, for use with Sky+, or more complex installations.

Telephone secondary outlets are provided on some products for connection of telephone or for interactive TV applications.

FEATURES

- Non Isolated
- Fully screened
- Earth terminal provided on TV modules
- Selected products with BT secondary outlets for interactive TV applications
- Selected products with supplementary TV outlet for back-feed for further distribution

BOX TYPES

FLUSH	FLUSH (FOR EXTRA WIRING SPACE)		SURFACE INSULATED	SURFACE METAL
1 GANG	861ZIC	866ZIC	K2140WHI	K2211ALM/K2213ALM
2 GANG	862ZIC	886ZIC	K2142WHI	K2212ALM/K2214ALM

Minimum recommended box depth 32mm

Note: Edge mounted modular products require 46mm box

Digital TV/FM and Telephone Outlets (Logic Plus and Modular Datacoms)

Installation

- When installing the TV co-axial cable ensure that all cable bends are smooth so that the inner insulation is not crushed or squashed, otherwise the TV signal quality may be affected
- Not suitable for loop-in loop-out installations
- Use CT100 cable (or equivalent)

TV Co-axial cable stripping details

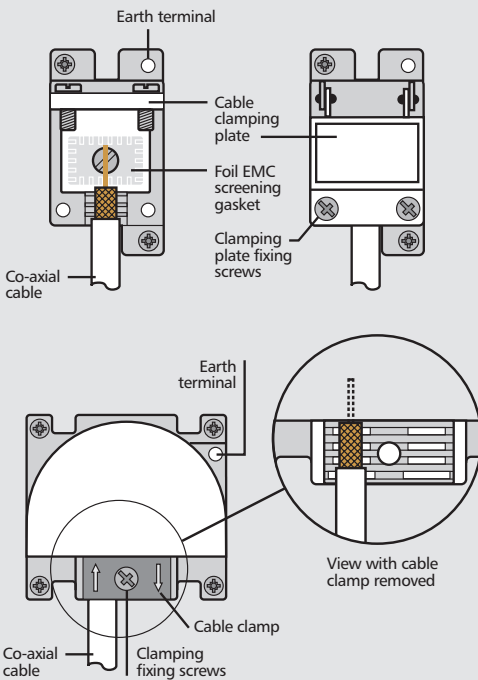
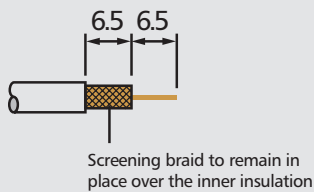

Telephone Outlet Connection

Carefully strip 50mm of the telephone cable outer sheath to expose the inner insulated conductors. Using the insertion tool supplied, (MK List no. 400NAT) carefully push each lead into the appropriate IDC terminals according to the wiring colour code stated in the telephone Wiring Scheme diagram.

Pins 1 and 6 are frequently unused, 4 wire cable may be used in these installations.

If an existing installation uses a different wiring colour code system, this should be retained on any new or extended installation.

Additional secondary extension outlets should be wired in parallel with the existing installation via the IDC terminals, (i.e. pin 1 to pin1, pin 2 to pin 2, etc).

In the event that the earth terminal is required to be used, the installer must ensure that a suitable earth conductor is present to connect to the earth terminal. (In the case of 2G products both TV modules should be earthed).

In the event that the earth terminal is required to be used, the installer must ensure that a suitable earth conductor is present to connect to the earth terminal. (In the case of 2G products both TV modules should be earthed).

Telephone Wiring Scheme

- 1 GREEN / white
- 2 BLUE / white
- 3 ORANGE / white
- 4 WHITE / orange
- 5 WHITE / blue
- 6 WHITE / green

Note: Main wire colour is shown in capitals

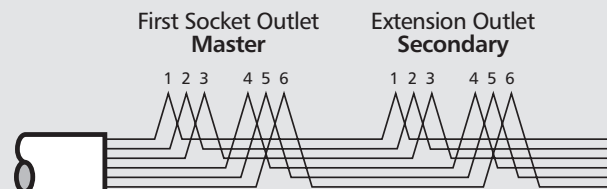
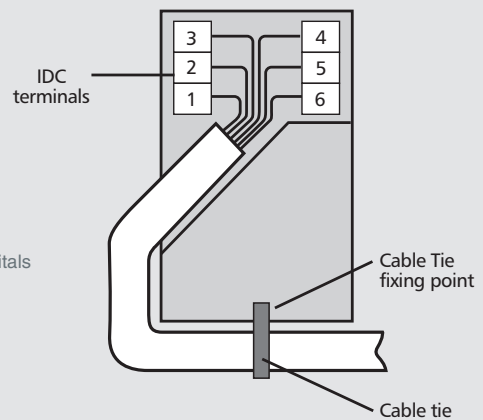

Wiring Devices Technical

– Logic Plus™

Combination Plates 2/4-gang Stacked Combination Plate

4 Gang Plate Description

The 4-gang Combination Plate carries 2x 2-gang 13A DP switched sockets, plus a Quad TV, FM/DAB, Satellite outlet, single TV (IEC Female) and an additional Telephone socket.

Additionally, there is a 4-module Euro area capable of accommodating any additional telephone or media products from the Euro modular range.



Quad TV, FM/DAB, Satellite outlet & additional TV Socket

As used on K3566 WHI

BT Telephone Socket

As used on K3566 WHI

4-module Euro Housing

This portion of the plate accepts up to 4 x 50mm high by 25mm wide Euro modules. (100mm x 50mm aperture)

TECHNICAL SPECIFICATION

FRONTPLATE

The frontplate complies with the mechanical strength requirements of BS 5733 2010.

SWITCHED SOCKET SPECIFICATION

Compliant to BS 1363 Part 2: 1995

ELECTRICAL

VOLTAGE RATING

250V a.c.

CURRENT RATING

13 Amp

TERMINAL CAPACITY

Live, Neutral & Earth

3 x 2.5mm²

3 x 4mm²

2 x 6mm² (standard)

PHYSICAL

AMBIENT OPERATING TEMPERATURE

-5°C to +40°C

IP RATING

IP2XD

MAX. INSTALLATION ALTITUDE

2000 metres

Note

- Pre-configured back boxes available shall be used with these plates. These are 853ZIC, which is 35mm deep, and for greater wiring space 854ZIC, which is 47mm deep
- These back boxes should always be used to ensure alignment of the fixing screws is correct and proper segmentation between mains and low voltage products is maintained
- Mains operated products and extra low voltage modules must not be installed within the same front plate aperture. Refers to BS 7671 IET Wiring regulations for detail
- When removing the fixing screws and front plate from an installation to gain access to low voltage modules, please be aware that there will also be access to the mains supply

2 Gang Plate Description

The 2-gang Combination Plate carries a 2-gang 13A DP switched sockets and an additional 4-module Euro area capable of accommodating any additional telephone or media products from the Euro modular range.

TECHNICAL SPECIFICATION

FRONTPLATE

The frontplate complies with the mechanical strength requirements of BS 5733 2010.

SWITCHED SOCKET SPECIFICATION

Compliant to BS 1363 Part 2: 1995

ELECTRICAL

VOLTAGE RATING

250V a.c.

CURRENT RATING

13 Amp

TERMINAL CAPACITY

Live, Neutral & Earth

3 x 2.5mm²

3 x 4mm²

2 x 6mm² (standard)

PHYSICAL

AMBIENT OPERATING TEMPERATURE

-5°C to +40°C

IP RATING

IP2XD

MAX. INSTALLATION ALTITUDE

2000 metres

Note

- Pre-configured back boxes available shall be used with these plates. These are 853ZIC, which is 35mm deep, and for greater wiring space 854ZIC, which is 47mm deep
- These back boxes should always be used to ensure alignment of the fixing screws is correct and proper segmentation between mains and low voltage products is maintained
- Mains operated products and extra low voltage modules must not be installed within the same front plate aperture. Refers to BS 7671 IET Wiring regulations for detail
- When removing the fixing screws and front plate from an installation to gain access to low voltage modules, please be aware that there will also be access to the mains supply

Wiring Devices Technical – Aspect

Combination Plate

Standards and approvals

All Aspect 13A socket outlets comply with BS 1363: Part 2:1995.

K24209 and K24210 comply with BS 5733:2010.

TECHNICAL SPECIFICATION

ELECTRICAL

VOLTAGE RATING

250V a.c.

CURRENT RATING

13A

TERMINAL CAPACITY

Live, neutral & earth

3 x 2.5mm²

3 x 4mm²

2 x 6mm² (stranded)

(Dual earth terminals)

PHYSICAL

AMBIENT OPERATING TEMPERATURE

-5°C to +40°C

IP RATING

IP2XD

MAX. INSTALLATION ALTITUDE

2000 metres

MOUNTING BOXES

Combination Plate List Number	47mm Mounting Box
K24206	870ZIC
K24207	870ZIC
K24208	868ZIC
K24209	858ZIC
K24210	869ZIC

Bespoke requirements can be achieved through the MK Design Service to deliver variation in colours, materials, finishes and markings.

Euro apertures can also be converted to grid-switch. For more information please visit www.mkelectric.co.uk or call 01268 563720



Description

A range of combination plates designed for ease of installation and having all the advantageous design features of the Aspect range.

These combination socket outlets provide interior designers and installers with a stylish and practical wiring device solution. The range also has larger euro module frontplates to house eight and twelve single euro modules without the inclusion of fixed socket outlets. The K24209 combination socket outlet, for example allows for the inclusion of up to eight single Euro modules, which could include datacoms, telecoms, plus TV and Satellite modules.

Alternatively, Euro Power Modules i.e. German, French/Belgium and American socket outlets may be used.

Note:

- Pre-configured back boxes are designed for use with the combination plates. These back boxes should always be used to ensure alignment of the fixing screws is correct and proper segregation between mains and extra low voltage products is maintained
- For Aspect products, back boxes must be installed 10mm sub flush to the wall surface
- Mains operated products and extra low voltage modules must not be installed within the same frontplate aperture. Refer to BS 7671: 2008 for details
- When removing the fixing screws and frontplate from an installation to gain access to low voltage modules, please be aware that there will also be access to the mains supply

All pre-fitted sockets come complete and are fitted with two earth terminals on a common busbar to provide a double earth facility for use when installations require a high integrity protective connection as specified within BS 7671, IET Wiring Regulations.

Wiring Devices Technical

– Aspect

Combination Plate

Features

- Metal-capped rockers designed to match the chosen front plate finish
- 3 pin operated safety shutter
- Printed terminal markings on grey rear mouldings for clearer identification
- Top access, angled terminals make wiring easier and quicker
- 3mm minimum switch contact gap
- Double pole switching
- Additional electrical safety from neutral 'make first', 'break last' feature
- Switch contacts with silver contacts on both surfaces for good continuity
- Dual earth terminals on pre-fitted sockets are for high integrity earthing
- Backed out and captive terminal screws on pre-fitted sockets
- Pre-configured backboxes to ensure alignment of the fixing screws is correct and proper segregation between circuits is maintained to comply with BS 7671 17th Edition wiring regulations

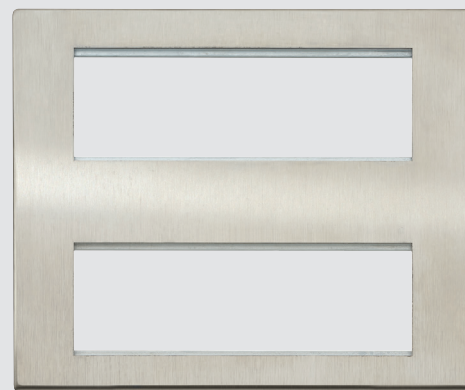

Installation

Aspect socket outlets can only be mounted on a wall. Do not mount or use as a trailing socket or where they may be subject to excessive moisture or dampness.

Install corresponding back box 10mm sub flush to finished wall surface.

Aspect combination plates are supplied with clip on segregator.

Dimensions (mm)

K24206 and K24207

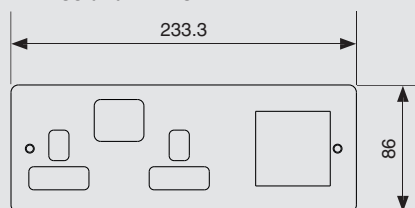

K24208

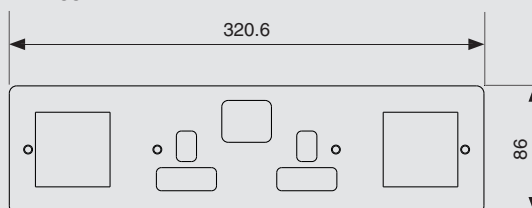

K24209

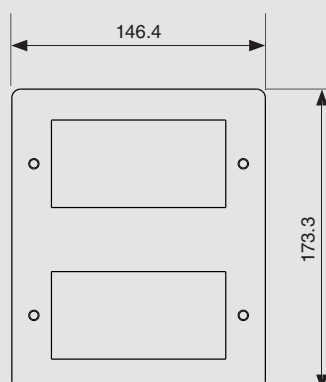

K24210

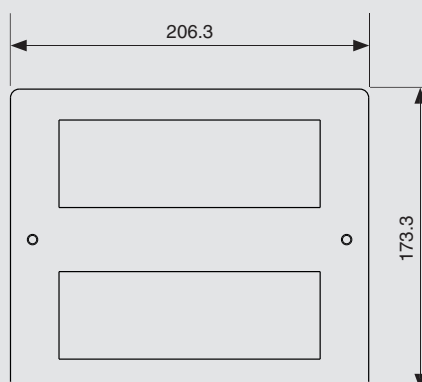

Wiring Devices Technical

– Edge™

Combination Plate

Standards and approvals

All Edge 13A socket outlets comply with BS 1363: Part 2:1995.

K14209 and K14210 comply with BS 5733:2010.

TECHNICAL SPECIFICATION

ELECTRICAL

VOLTAGE RATING
250V a.c.

CURRENT RATING
13A

TERMINAL CAPACITY
Live, neutral & earth
3 x 2.5mm²
3 x 4mm²
2 x 6mm² (stranded)
(Dual earth terminals)

PHYSICAL

AMBIENT OPERATING TEMPERATURE
–5°C to +40°C

IP RATING
IP2XD

MAX. INSTALLATION ALTITUDE
2000 metres

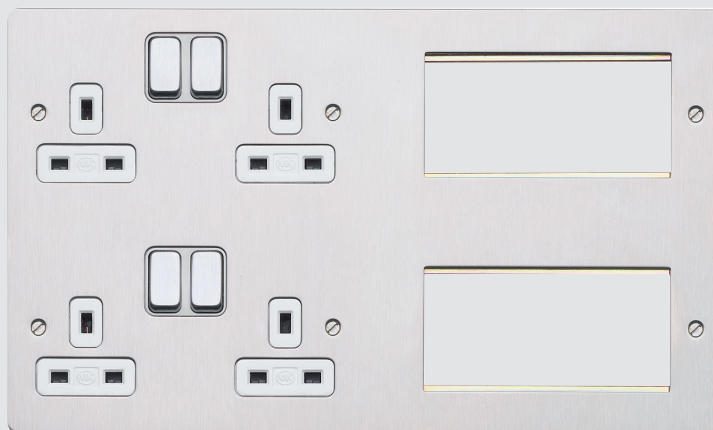

Description

A range of combination plates designed for ease of installation and having all the advantageous design features of the Edge range.

These combination socket outlets provide interior designers and installers with a stylish and practical wiring device solution. The range also has larger euro module frontplates to house eight and twelve single euro modules without the inclusion of fixed socket outlets. The K14100 combination socket outlet, for example allows for the inclusion of up to eight single Euro modules, which could include datacoms, telecoms, plus TV and Satellite modules.

Alternatively, Euro Power Modules i.e. German, French/Belgium and American socket outlets may be used.

Note:

- Pre-configured back boxes are designed for use with the combination plates. These back boxes should always be used to ensure alignment of the fixing screws is correct and proper segregation between mains and extra low voltage products is maintained
- For Edge products, back boxes must be installed flush to the wall surface
- Mains operated products and extra low voltage modules must not be installed within the same frontplate aperture. Refer to BS 7671: 2008 for details
- When removing the fixing screws and frontplate from an installation to gain access to low voltage modules, please be aware that there will also be access to the mains supply

All pre-fitted sockets come complete and are fitted with two earth terminals on a common busbar to provide a double earth facility for use when installations require a high integrity protective connection as specified within BS 7671, IET Wiring Regulations.

MOUNTING BOXES

Combination Plate List Number	35mm Mounting Box	47mm Mounting Box
K14200	K14201	K14202
K14205	K14206	K14207
K14100	K14101	K14102
K14216		867ZIC
K14217		867ZIC
K14208		868ZIC
K14209		858ZIC
K14210		869ZIC

Bespoke requirements can be achieved through the MK Design Service to deliver variation in colours, materials, finishes and markings.

Euro apertures can also be converted to grid-switch. For more information please visit www.mkelectric.co.uk or call 01268 563720



Combination plates allow the use of a variety of power and data modules making them ideal for hotels.

Wiring Devices Technical

– Edge™

Combination Plate

Features

- Metal-capped rockers designed to match the chosen front plate finish
- 3 pin operated safety shutter
- Printed terminal markings on grey rear mouldings for clearer identification
- Top access, angled terminals make wiring easier and quicker
- 3mm minimum switch contact gap
- Double pole switching
- Additional electrical safety from neutral 'make first', 'break last' feature
- Switch contacts with silver contacts on both surfaces for good continuity
- Dual earth terminals on pre-fitted sockets are for high integrity earthing
- Backed out and captive terminal screws on pre-fitted sockets
- Pre-configured backboxes to ensure alignment of the fixing screws is correct and proper segregation between circuits is maintained to comply with BS 7671 17th Edition wiring regulations

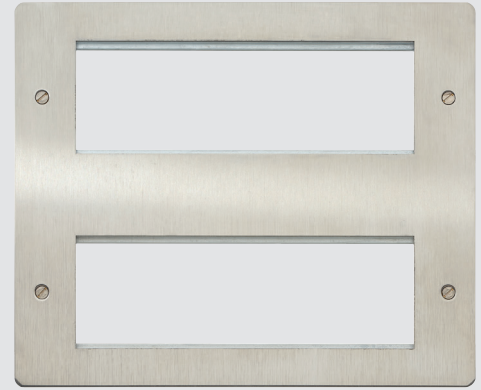

Installation

Edge socket outlets can be mounted on either a wall or suitable bench mounted trunking. Do not mount or use as a trailing socket or where they may be subject to excessive moisture or dampness.

Dimensions (mm)

K14216 and K14217

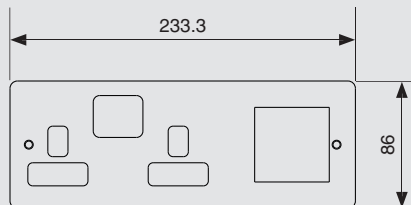

K14200

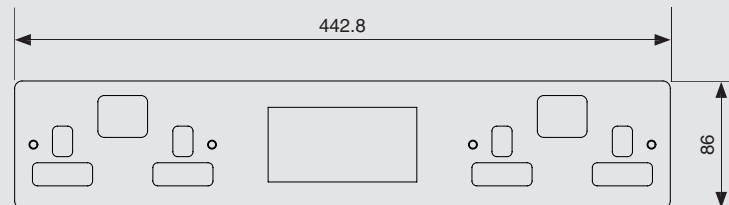

K14209

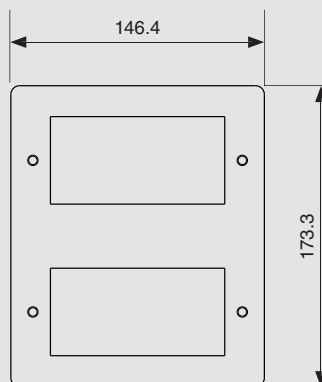

K14210

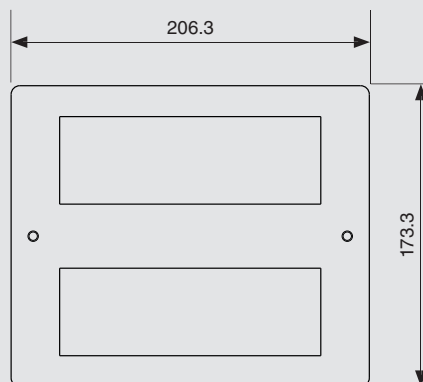

K14100

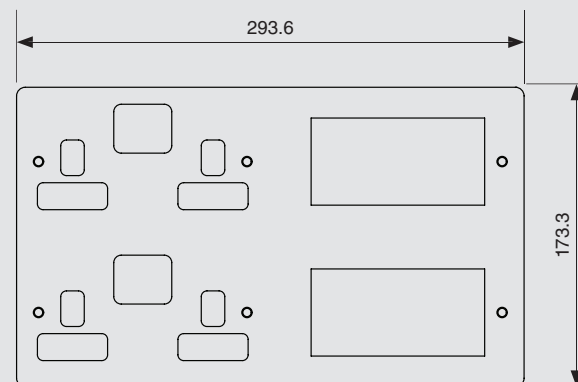

K14208

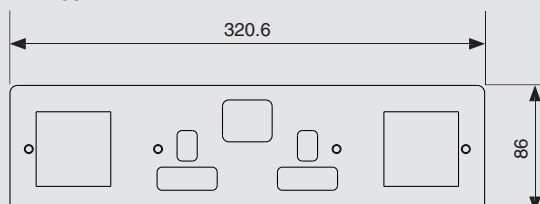

K14205

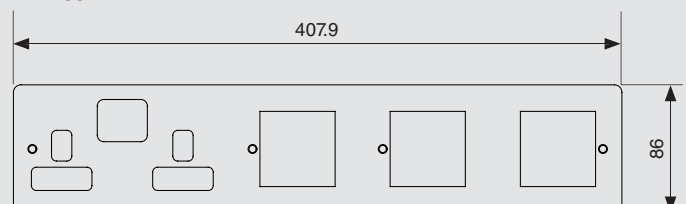

Wiring Devices Technical

– Edge™

Key Operated Switchsocket Outlet

Standards and approvals

All Edge 13A socket outlets comply with BS 1363: Part 2:1995.

TECHNICAL SPECIFICATION

ELECTRICAL

VOLTAGE RATING

250V a.c.

CURRENT RATING

13A

TERMINAL CAPACITY

Live, neutral & earth

3 x 2.5mm²

2 x 4mm²

1 x 6mm² (stranded)

(Dual earth terminals)

PHYSICAL

AMBIENT OPERATING TEMPERATURE

-5°C to +40°C

IP RATING

IP2XD

MAX. INSTALLATION ALTITUDE

2000 metres



Description

The Key Operated 13 amp socket is designed for ease of installation and has all the design features of the Edge range. The built-in lock ensures that power cannot be provided without key operation making it ideal for communal areas such as hotel lobbies. The key can be removed from the lock in the on or off position leaving the socket with or without power supply.

The product can be quickly installed as replacement for existing 2 gang 13 amp sockets or in a new installation (assuming suitable 47mm deep mounting box is in position).

Installation

Edge socket outlets can be wall or bench mounted. Do not mount or use as a trailing socket or where they may be subject to excessive moisture or dampness.

Features

- Built in lock ensures power cannot be provided without key operation
- Printed terminal markings on grey rear mouldings for clearer identification
- Double pole switching
- Only one size of screwdriver required for installation
- Dual earth terminals for high integrity earthing

Note: The lock fitted to each socket is universal. i.e. a common key profile. However, the keys are different to those used on MK Key Operated Fire Alarm Isolator Switches, for added security.

Wiring Devices Technical

– Edge™

Edge™ Technical: General information

Mounting Boxes

Due to the slimline design MK Edge accessories require deeper back boxes than standard. They are designed to fit into folded metal boxes that comply with BS 4662. To ensure products can be correctly installed, the box must always be installed flush or sub flush to the surface to a maximum depth of 6mm.

The recommended depth of boxes for the different types of wiring accessories are as follows:

MOUNTING BOXES	
Product	Box Depth
Socket Outlets	35mm
Lockable Socket	47mm
Lockable Switch	47mm
German style 2 pole + E Socket Outlet mounted in Euro Frame	47mm
Connection Units	47mm
Plateswitches	35mm
Grid System Switches*	35mm
Dimmer Switches	35mm
Telephone, Television and Data Outlets	35mm
Cooker Control and 50A Switches	47mm
Shaver Supply Units	47mm
32A Triple Pole and Neutral Switch	List no. 5268ALM

*Note: If Grid system accessories are to be fitted and the installation requires the attachment of conduit via nuts inside the mounting box, then it is recommended that a box depth of 47mm is used.

Fixing Screws

The surface head of Edge fixing screws is treated and compliment the finish of the frontplate. To prevent damage to the fixing screw extreme care is required. It is recommended that a screwdriver with a maximum blade of 3.5mm is used.

Aspect Installation

The MK 'Aspect' range of products consists of the main product complete with its support frame and clipping medium, plus a separate frontplate. The product is mounted to the wall, after wiring, and the front plate clipped onto the frame.

1. The frontplate is supplied loose to aid installation.
2. Make sure not to crush or deform the spring steel clips situated along one edge of the product support frame.
3. A gasket is also supplied with each product, which may prove useful on uneven walls. See note 5 below.
4. Using the gasket with all switches and the German socket, will ensure full compliance with the appropriate standards.
5. Both standards set out to guarantee full engagement of the frontplate on uneven surfaces, even when there is a mismatch of as much as 1mm between the distance the main body of the product is from the wall and that of the front plate.
6. Where no gasket is used, if thick wallpapers are cut such that they fit around the support frame and therefore remain under the edge of the frontplate, full plate engagement with the clips may be restricted.

Note: When installing Aspect do not over tighten screws, so as to prevent damage or distortion to the product or support frame.

Frontplate Removal

1. Turn off the power supply.
2. Carefully slide a screwdriver between the ramp on the main body of the product and the notch in the lower right hand edge of the plate.
3. On uneven walls, make sure the screwdriver does not go between the spring steel ramp and the wall, or damage to the wall and/or product could result.
4. Carefully slide the blade upwards and then gently lift the handle away from the wall, which will lever the plate away from the first clip. See Fig.4.
5. With the first clip released, support the plate with one hand and continue to move the blade to the left under.

Data products in euromounting frames

Products operating at extra low voltage levels (<50v) must not be mounted in the same Euro enclosures as equipment rated in excess of 50v.

Cleaning Frontplates

In order to protect the quality surface finish of the front plate, periodic cleaning should only consist of polishing with a dry lint free soft cloth.

FIGURE 1A

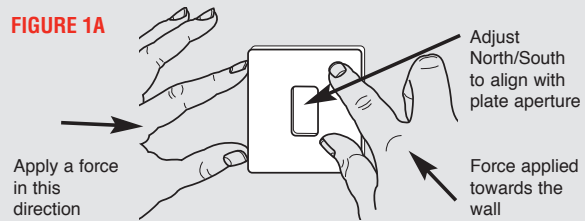
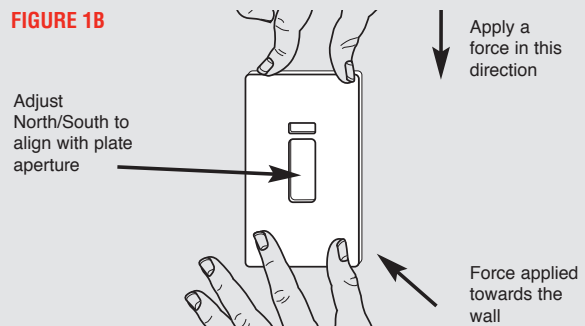

FIGURE 1B



Frontplate Installation

FIGURE 2

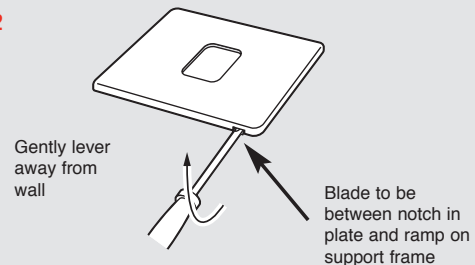

FIGURE 3

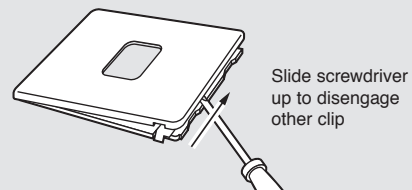

FIGURE 4

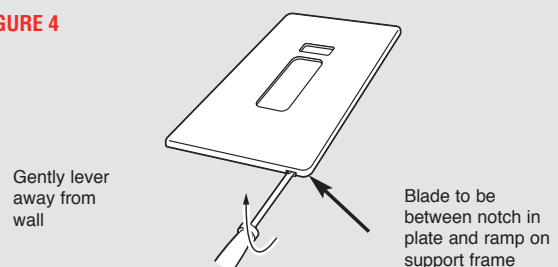
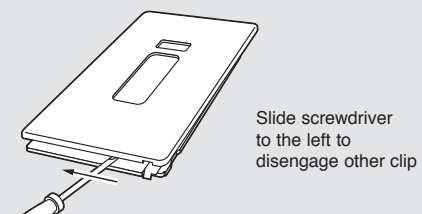

FIGURE 5



Frontplate Removal

Decorative Technical: General information

Earthing: All Metal Frontplate Products

To comply with the latest edition of the BS 7671 IET regulations: the metal front plate must be earthed. All earth terminals provided must be connected to the protective earth conductor.

Telephone Secondary and Data Sockets

To provide customers with a high level of flexibility the voice and data decorative wiring devices are available in modular formats.

For example to produce a Telephone Secondary Socket the following items are required:

RANGE	PRODUCTS REQUIRED	
Albany Plus	K181	K5821
Aspect	K24181	K5821
Edge	K14181	K5821

Or

RANGE	PRODUCTS REQUIRED		
Albany Plus	K182	K5821	2 x K186
Aspect	K24182	K5821	2 x K186
Edge	K14182	K5821	2 x K186