

THIS DOCUMENT IS THE PROPERTY OF KEYSTONE ELECTRONICS CORP. AND SHALL NOT BE REPRODUCED, DISTRIBUTED OR USED AS A BASIS FOR MANUFACTURE WITHOUT PRIOR WRITTEN PERMISSION FROM KEYSTONE ELECTRONICS CORP.

MOUNTING DETAIL

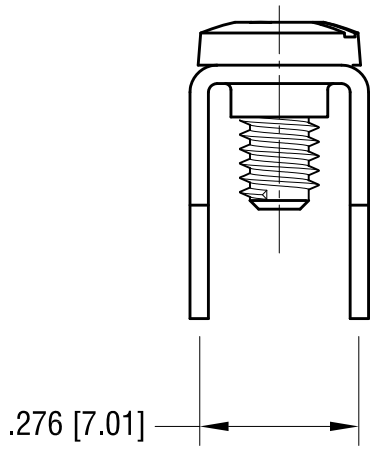
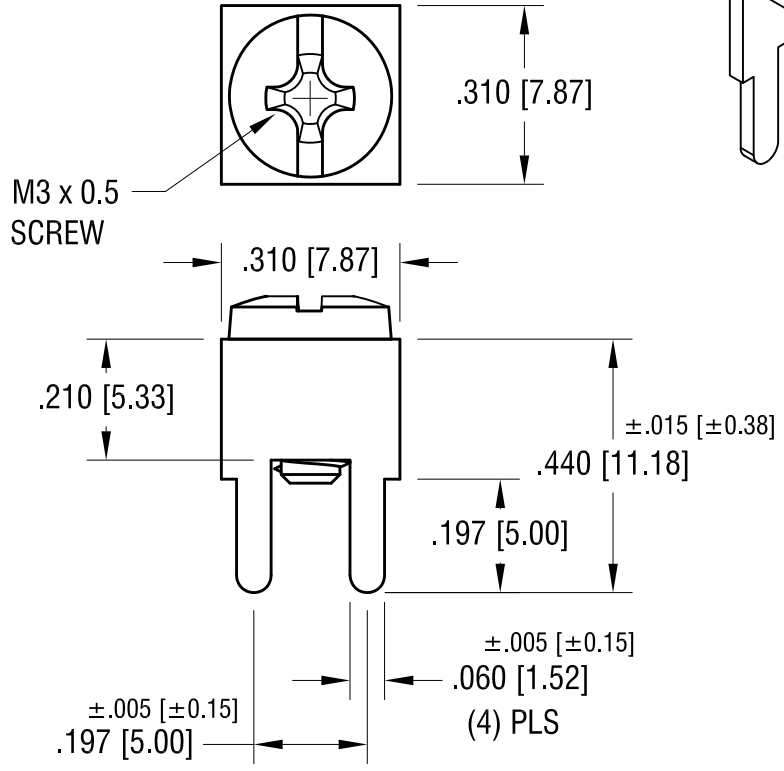
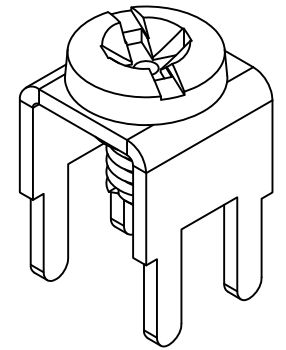
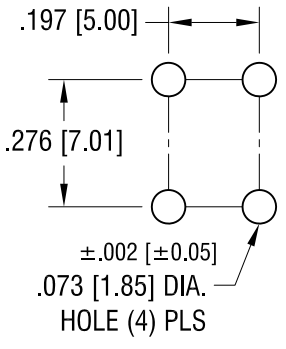

NOTE:

- 1. TERMINAL:
 MAT'L - .032 [0.81] TH'K BRASS, MATTE TIN PLATE
 SCREW : ONE (1) M3 x 0.5 SCREW (CAPTIVE)
 MAT'L - BRASS, NICKEL PLATE
 HEAD OF SCREW IS POWDER COATED
 WITH COLOR AS INDICATED IN CHART.

PC SCREW TERMINAL WITH COLORED SCREW HEAD

PART NO.	HEAD COLOR	PART NO.	HEAD COLOR
7772-2	RED	7772-5	BLUE
7772-3	BLACK	7772-6	GREEN
7772-4	WHITE	7772-7	YELLOW

KEYSTONE ELECTRONICS CORP.

www.keyelco.com • ASTORIA, N.Y. 11105-2017 • Tel (718) 956-8900

PART NAME				PC SCREW TERMINAL			
MATERIAL				AS NOTED			
FINISH		DRN BY		DATE		SCALE	
AS NOTED		NT		1.27.10		3X	
TOLERANCES		INCH		[MM]		CODE	
DECIMAL		± .010		[± 0.25]		C	
ANGULAR		± 1°		UNLESS OTHERWISE SPECIFIED		DWG NO.	
						7772-2 - 7772-7	

DATE	DESCRIPTION	REV.
------	-------------	------

Mouser Electronics

Authorized Distributor

Click to View Pricing, Inventory, Delivery & Lifecycle Information:

[Keystone Electronics:](#)

[7772-2](#)