

1 2 3 4 5 6

A

B

C

D

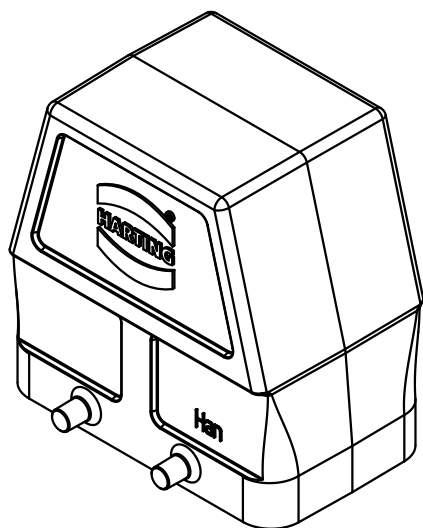
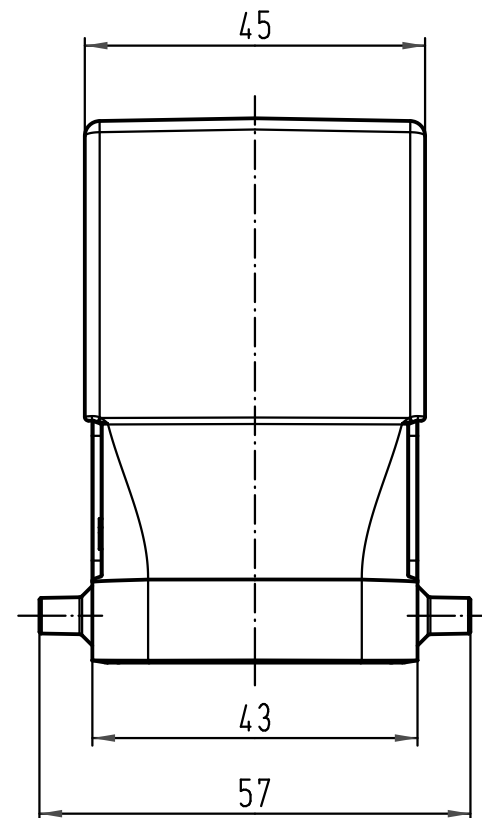
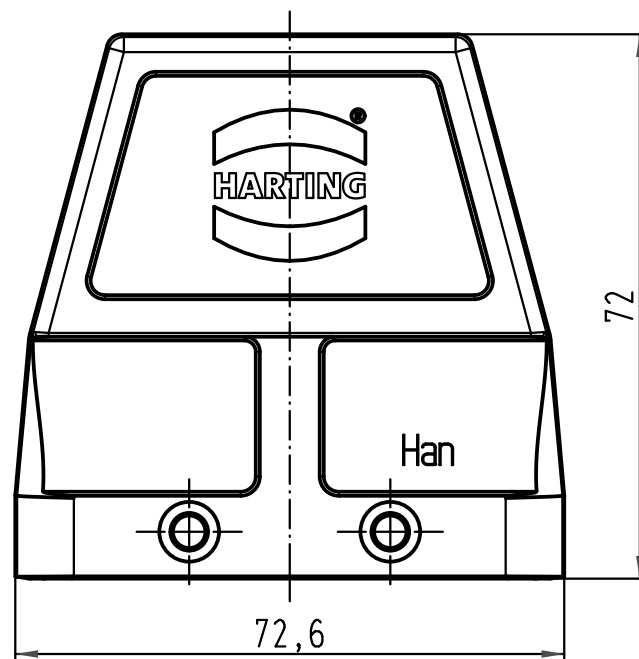

All Dimensions in mm Original Size DIN A 4		Techn. Character.			Nicht tolerierte Masse/ Free size tolerances	
			Dat.	Name	Massstab/ Scale 1:1	Han 10B-g Gehäuse hood
		Detail.	23.08.00	ROH.		
		Insp.		KR		
		Stand.				
412724	21.02.07	Bor	HARTING Electric GmbH & Co. KG			TB 09 30 010 0801
28257			D-32339 Espelkamp			
Mod.	Dat.	Name				Sub. TB 09 30 0.. 0801 v. 23.03.95
						Blatt/ page