

Part No. PCMC3

Issue B Date 25/01/2001

Drawn  Date 25/01/2001

Approved P.J.H Date 25/01/2001

Unless otherwise stated All Dimensions are in mm

General tolerance +/- 0.25mm

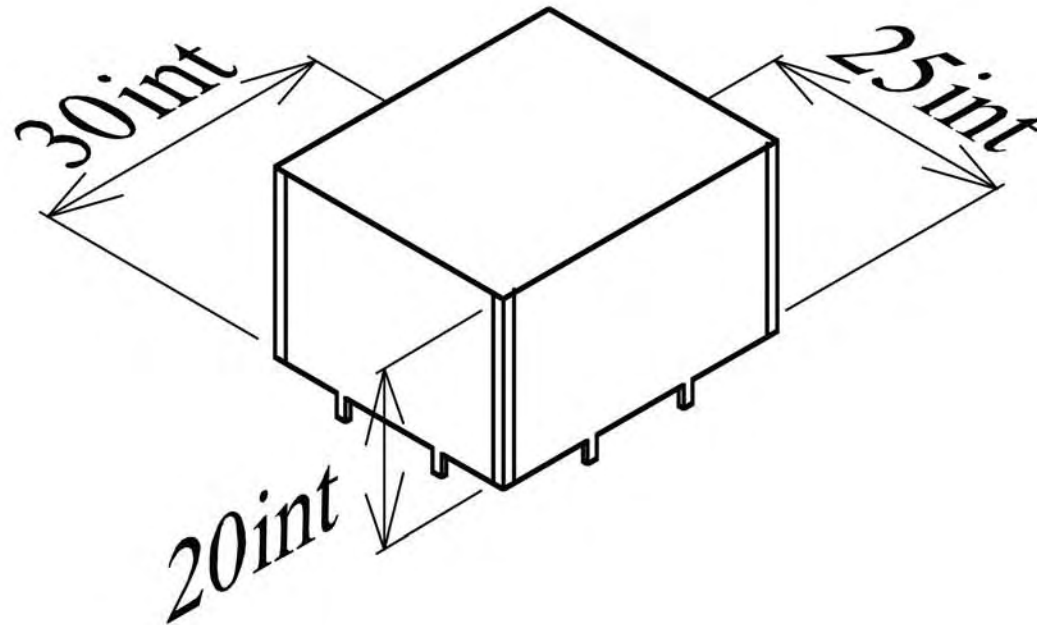

Specification

Material: Tinplate to BS EN 1202
Construction: Close Butt Jointed Corners
Thickness: 0.54mm
Surface resistivity: $20 \times 10^{-6} \Omega$ per square
Conductivity: 5×10^4 mho

PCB Pin Size & Pitch

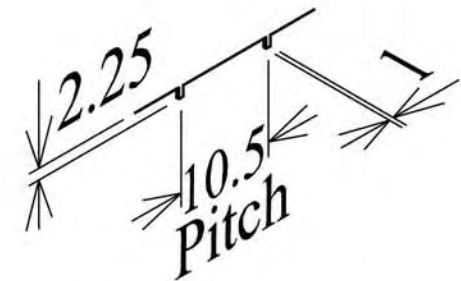

PCB Pin pitch tolerance +/- 0.10mm

THIS DRAWING IS THE PROPERTY OF PERANCEA LTD AND MAY NOT BE COPIED OR REPRODUCED WITHOUT OUR WRITTEN CONSENT

PERANCEA LTD

ENCLOSURE AND INSTRUMENT CASE
DESIGNERS AND MANUFACTURERS

Unit 36, Silicon Business Centre, Greenford, UB6 7JZ

Telephone: 020 8365 2520

Fax: 020 8566 7217

Email: sales@perancea.com

Web: www.perancea.com