

Power supply unit - QUINT-PS/3AC/24DC/40



2866802

<https://www.phoenixcontact.com/us/products/2866802>

Please be informed that the data shown in this PDF document is generated from our Online Catalog. Please find the complete data in the user documentation. Our General Terms of Use for Downloads are valid.



Primary-switched power supply unit, QUINT POWER, Screw connection, DIN rail mounting, SFB Technology (Selective Fuse Breaking), input: 3-phase, output: 24 V DC / 40 A

Product Description

QUINT POWER power supplies with maximum functionality

QUINT POWER circuit breakers magnetically and therefore quickly trip at six times the nominal current, for selective and therefore cost-effective system protection. The high level of system availability is additionally ensured, thanks to preventive function monitoring, as it reports critical operating states before errors occur.

Reliable starting of heavy loads takes place via the static power reserve POWER BOOST. Thanks to the adjustable voltage, all ranges between 5 V DC ... 56 V DC are covered.

Your advantages

- Reliable starting of difficult loads
- High level of system availability even in the event of permanent phase failure
- Preventive function monitoring

Power supply unit - QUINT-PS/3AC/24DC/40



2866802

<https://www.phoenixcontact.com/us/products/2866802>

Commercial Data

Item number	2866802
Packing unit	1 pc
Minimum order quantity	1 pc
Sales Key	C14
Product Key	CMPQ33
Catalog Page	Page 211 (C-4-2017)
GTIN	4046356152877
Weight per Piece (including packing)	2,955 g
Weight per Piece (excluding packing)	2,954 g
Customs tariff number	85044030
Country of origin	TH

Technical Data

Input data

AC operation

Nominal input voltage range	3x 400 V AC ... 500 V AC
Input voltage range	3x 320 V AC ... 575 V AC
	2x 360 V AC ... 575 V AC
	450 V DC ... 800 V DC
Input voltage range AC	Not approved by UL
Input voltage range DC	450 V DC ... 800 V DC
Voltage type of supply voltage	AC/DC
Inrush current	< 15 A
Inrush current integral (I^2t)	< 1 A ² s
AC frequency range	45 Hz ... 65 Hz
Frequency range DC	0 Hz
Mains buffering time	> 25 ms (400 V AC)
	> 35 ms (500 V AC)
Current consumption	3x 2.1 A (400 V AC)
	3x 1.7 A (500 V AC)
	1.7 A (600 V DC)
Nominal power consumption	1342 VA
Protective circuit	Transient surge protection; Varistor, gas-filled surge arrester
Power factor (cos phi)	0.76
Typical response time	< 0.5 s
Permissible backup fuse	B6 B10 B16 AC:
Permissible DC backup fuse	DC: Connect a suitable fuse upstream
Recommended breaker for input protection	6 A ... 16 A (AC: Characteristics B, C, D, K)
Discharge current to PE	< 3.5 mA

Output data

Efficiency	> 94 % (at 400 V AC and nominal values)
Output characteristic	U/I
Nominal output voltage	24 V DC \pm 1 %
Setting range of the output voltage (U_{Set})	18 V DC ... 29.5 V DC (> 24 V DC, constant capacity restricted)
Nominal output current (I_N)	40 A (-25 °C ... 60 °C, U_{OUT} = 24 V DC)
POWER BOOST (I_{Boost})	45 A (-25 °C ... 40 °C permanent, U_{OUT} = 24 V DC)
Selective Fuse Breaking (I_{SFB})	215 A (12 ms)
Magnetic circuit breaker tripping	B2 / B4 / B6 / B10 / B16 / B25 / C2 / C4 / C6 / C13
Derating	60 °C ... 70 °C (2.5%/K)
Feedback voltage resistance	max. 35 V DC
Protection against overvoltage at the output (OVP)	< 35 V DC
Control deviation	< 1 % (change in load, static 10 % ... 90 %)
	< 3 % (change in load, dynamic 10 % ... 90 %)

Power supply unit - QUINT-PS/3AC/24DC/40



2866802

<https://www.phoenixcontact.com/us/products/2866802>

	< 0.1 % (change in input voltage ± 10 %)
Residual ripple	< 40 mV _{PP} (with nominal values)
Short-circuit-proof	yes
Output power	960 W
Peak switching voltages nominal load	< 5 mV _{PP} (at nominal values, 20 MHz)
Maximum no-load power dissipation	18 W
Power loss nominal load max.	63 W
Rise time	< 0.15 s (U_{OUT} (10 % ... 90 %))
Connection in parallel	yes, for redundancy and increased capacity
Connection in series	yes

Signal: DC OK active

Output description	$U_{OUT} > 0.9 \times U_N$: High signal
Switching voltage range	18 V DC ... 24 V DC
Output voltage	+ 24 V DC
Maximum inrush current	≤ 20 mA (short-circuit-proof)
Continuous load current	≤ 20 mA

Signal: DC OK floating

Output description	Relay contact, $U_{OUT} > 0.9 \times U_N$: Contact closed
Maximum switching voltage	30 V AC/DC
	24 V DC
Maximum inrush current	0.5 A
	1 A
Continuous load current	≤ 1 A

Signal: POWER BOOST, active

Output description	$I_{OUT} < I_N$: High signal
Switching voltage range	18 V DC ... 24 V DC
Output voltage	+ 24 V DC
Maximum inrush current	≤ 20 mA (short-circuit-proof)
Continuous load current	≤ 20 mA

Signal: DC OK active

Output description	$U_{OUT} > 0.9 \times U_N$: High signal
Switching voltage range	18 V DC ... 24 V DC
Output voltage	+ 24 V DC
Maximum inrush current	≤ 20 mA (short-circuit-proof)
Continuous load current	≤ 20 mA

Signal: DC OK floating

Output description	Relay contact, $U_{OUT} > 0.9 \times U_N$: Contact closed
Maximum switching voltage	30 V AC/DC
	24 V DC
Maximum inrush current	0.5 A
	1 A

Power supply unit - QUINT-PS/3AC/24DC/40



2866802

<https://www.phoenixcontact.com/us/products/2866802>

Continuous load current	$\leq 1 \text{ A}$
-------------------------	--------------------

Signal: POWER BOOST, active

Output description	$I_{\text{OUT}} < I_{\text{N}}$: High signal
Switching voltage range	18 V DC ... 24 V DC
Output voltage	+ 24 V DC
Maximum inrush current	$\leq 20 \text{ mA}$ (short-circuit-proof)
Continuous load current	$\leq 20 \text{ mA}$

Signal: DC OK active

Output description	$U_{\text{OUT}} > 0.9 \times U_{\text{N}}$: High signal
Switching voltage range	18 V DC ... 24 V DC
Output voltage	+ 24 V DC
Maximum inrush current	$\leq 20 \text{ mA}$ (short-circuit-proof)
Continuous load current	$\leq 20 \text{ mA}$

Signal: DC OK floating

Output description	Relay contact, $U_{\text{OUT}} > 0.9 \times U_{\text{N}}$: Contact closed
Maximum switching voltage	30 V AC/DC
	24 V DC
Maximum inrush current	0.5 A
	1 A
Continuous load current	$\leq 1 \text{ A}$

Signal: POWER BOOST, active

Output description	$I_{\text{OUT}} < I_{\text{N}}$: High signal
Switching voltage range	18 V DC ... 24 V DC
Output voltage	+ 24 V DC
Maximum inrush current	$\leq 20 \text{ mA}$ (short-circuit-proof)
Continuous load current	$\leq 20 \text{ mA}$

Connection data

Input

Connection method	Screw connection
Conductor cross section solid min.	0.2 mm ²
Conductor cross section solid max.	6 mm ²
Conductor cross section flexible min.	0.2 mm ²
Conductor cross section flexible max.	4 mm ²
Conductor cross section AWG min.	18
Conductor cross section AWG max.	10
Stripping length	7 mm
Screw thread	M3
Tightening torque, min	0.5 Nm
Tightening torque max	0.6 Nm

Output

Power supply unit - QUINT-PS/3AC/24DC/40



2866802

<https://www.phoenixcontact.com/us/products/2866802>

Connection method	Screw connection
Conductor cross section solid min.	0.5 mm ²
Conductor cross section solid max.	16 mm ²
Conductor cross section flexible min.	0.5 mm ²
Conductor cross section flexible max.	16 mm ²
Conductor cross section AWG min.	8
Conductor cross section AWG max.	6
Stripping length	10 mm
Screw thread	M4
Tightening torque, min	1.2 Nm
Tightening torque max	1.5 Nm

Signal

Connection method	Screw connection
Conductor cross section solid min.	0.2 mm ²
Conductor cross section solid max.	6 mm ²
Conductor cross section flexible min.	0.2 mm ²
Conductor cross section flexible max.	4 mm ²
Conductor cross section AWG min.	18
Conductor cross section AWG max.	10
Screw thread	M3
Tightening torque, min	0.5 Nm
Tightening torque max	0.6 Nm

LED signaling

Types of signaling	LED
	Active switching output
	Relay contact
Operating voltage display	Green LED

Signal output: DC OK active

Status display	$U_{OUT} > 0.9 \times U_N$: "DC OK" LED green
Note on status display	$U_{OUT} < 0.9 \times U_N$: Flashing "DC OK" LED

Signal output: DC OK floating

Status display	$U_{OUT} > 0.9 \times U_N$: "DC OK" LED green
Note on status display	$U_{OUT} < 0.9 \times U_N$: Flashing "DC OK" LED

Signal output: POWER BOOST, active

Status display	$I_{OUT} > I_N$: LED "BOOST" yellow
----------------	--------------------------------------

Electrical properties

Number of phases	3.00
Insulation voltage input/output	4 kV AC (type test)
	2 kV AC (routine test)
Insulation voltage output / PE	500 V DC (routine test)

Power supply unit - QUINT-PS/3AC/24DC/40



2866802

<https://www.phoenixcontact.com/us/products/2866802>

Insulation voltage input / PE	3.5 kV AC (type test)
	2 kV AC (routine test)

Product properties

Product type	Power supply
MTBF (IEC 61709, SN 29500)	> 880000 h (25 °C)
	> 500000 h (40 °C)
	> 216000 h (60 °C)

Insulation characteristics

Protection class	I
Degree of pollution	2

Dimensions

Width	96 mm
Height	130 mm
Depth	176 mm

Installation dimensions

Installation distance right/left	5 mm / 5 mm
Installation distance top/bottom	50 mm / 50 mm

Alternative assembly

Width	176 mm
Height	130 mm
Depth	99 mm

Mounting

Mounting type	DIN rail mounting
Assembly instructions	alignable: $P_N \geq 50\%$, 5 mm horizontally, 15 mm next to active components, 50 mm vertically alignable: $P_N < 50\%$, 0 mm horizontally, 40 mm vertically top, 20 mm vertically bottom
Mounting position	horizontal DIN rail NS 35, EN 60715
With protective coating	No

Material specifications

Housing material	Metal
Hood version	Galvanized sheet steel, free from chrome (VI)
Side element version	Aluminum

Environmental and real-life conditions

Ambient conditions

Degree of protection	IP20
Ambient temperature (operation)	-25 °C ... 70 °C (> 60 °C Derating: 2,5 %/K)
Ambient temperature (storage/transport)	-40 °C ... 85 °C

Power supply unit - QUINT-PS/3AC/24DC/40



2866802

<https://www.phoenixcontact.com/us/products/2866802>

Ambient temperature (start-up type tested)	-40 °C
Maximum altitude	4000 m
Climatic class	3K3 (in acc. with EN 60721)
Max. permissible relative humidity (operation)	≤ 95 % (at 25 °C, non-condensing)
Shock	18 ms, 30g, in each space direction (according to IEC 60068-2-27)
Vibration (operation)	5 Hz ... 100 Hz resonance search 0.7g, 90 min., resonance frequency 0.7g, 90 min. (in accordance with DNV GL Class A)

Standards and regulations

Rail applications	EN 50121-4 EN 50121-3-2
Standard – Limitation of mains harmonic currents	EN 61000-3-2
Standard - Electrical safety	IEC 61010-2-201 (SELV)
Standard - Equipment safety	GS (tested safety)
Standard – Safety extra-low voltage	IEC 61010-1 (SELV) IEC 61010-2-201 (PELV)
Standard - Safe isolation	IEC 61010-2-201
Standard - safety for equipment for measurement, control, and laboratory use	IEC 61010-1
Standard - surge resistance	VDE 0160 (curve W2)

Overvoltage category

EN 62477-1	III
------------	-----

Approval data

CSA	CAN/CSA-C22.2 No. 60950-1-07 CSA-C22.2 No. 107.1-01
Shipbuilding approval	DNV GL (EMC A), ABS, LR, RINA, NK, BV
UL approvals	UL Listed UL 508 UL/C-UL Recognized UL 60950-1 (3-wire + PE, star net) UL ANSI/ISA-12.12.01 Class I, Division 2, Groups A, B, C, D (Hazardous Location)

Conformity/Approvals

SIL in accordance with IEC 61508	0
----------------------------------	---

EMC data

Low Voltage Directive	Conformance with Low Voltage Directive 2014/35/EC
Electromagnetic compatibility	Conformance with EMC Directive 2014/30/EU
EMC requirements for noise emission	EN 61000-6-3 EN 61000-6-4
EMC requirements for noise immunity	EN 61000-6-1 EN 61000-6-2
Noise immunity	EN 61000-6-2

Electrostatic discharge

Power supply unit - QUINT-PS/3AC/24DC/40



2866802

<https://www.phoenixcontact.com/us/products/2866802>

Standards/regulations	EN 61000-4-2
Electrostatic discharge	
Contact discharge	8 kV (Test Level 4)
Discharge in air	15 kV (Test Level 4)
Comments	Criterion A
Electromagnetic HF field	
Standards/regulations	EN 61000-4-3
Electromagnetic HF field	
Frequency range	80 MHz ... 1 GHz
Test field strength	20 V/m (Test Level 3)
Frequency range	1 GHz ... 2 GHz
Test field strength	10 V/m (Test Level 3)
Frequency range	2 GHz ... 3 GHz
Test field strength	10 V/m (Test Level 3)
Comments	Criterion A
Fast transients (burst)	
Standards/regulations	EN 61000-4-4
Fast transients (burst)	
Input	4 kV (Test Level 4 - asymmetrical)
Output	2 kV (Test Level 3 - asymmetrical)
Signal	2 kV (Test Level 4 - asymmetrical)
Comments	Criterion A
Surge voltage load (surge)	
Standards/regulations	EN 61000-4-5
Input	2 kV (Test Level 3 - symmetrical)
	6 kV (Test Level 4 - asymmetrical)
Output	1 kV (Test Level 2 - symmetrical)
	2 kV (Test Level 3 - asymmetrical)
Signal	1 kV (Test Level 2 - asymmetrical)
Comments	Criterion A
Conducted interference	
Standards/regulations	EN 61000-4-6
Conducted interference	
I/O/S	asymmetrical
Frequency range	0.15 MHz ... 80 MHz
Comments	Criterion A
Voltage	10 V (Test Level 3)
Emitted interference	
Standards/regulations	EN 61000-6-3

Power supply unit - QUINT-PS/3AC/24DC/40



2866802

<https://www.phoenixcontact.com/us/products/2866802>

Radio interference voltage in acc. with EN 55011	EN 55011 (EN 55022) Class B, area of application: Industry and residential
Emitted radio interference in acc. with EN 55011	EN 55011 (EN 55022) Class B, area of application: Industry and residential
Criterion A	Normal operating behavior within the specified limits.
Criterion B	Temporary impairment to operational behavior that is corrected by the device itself.

Power supply unit - QUINT-PS/3AC/24DC/40



2866802

<https://www.phoenixcontact.com/us/products/2866802>

Drawings

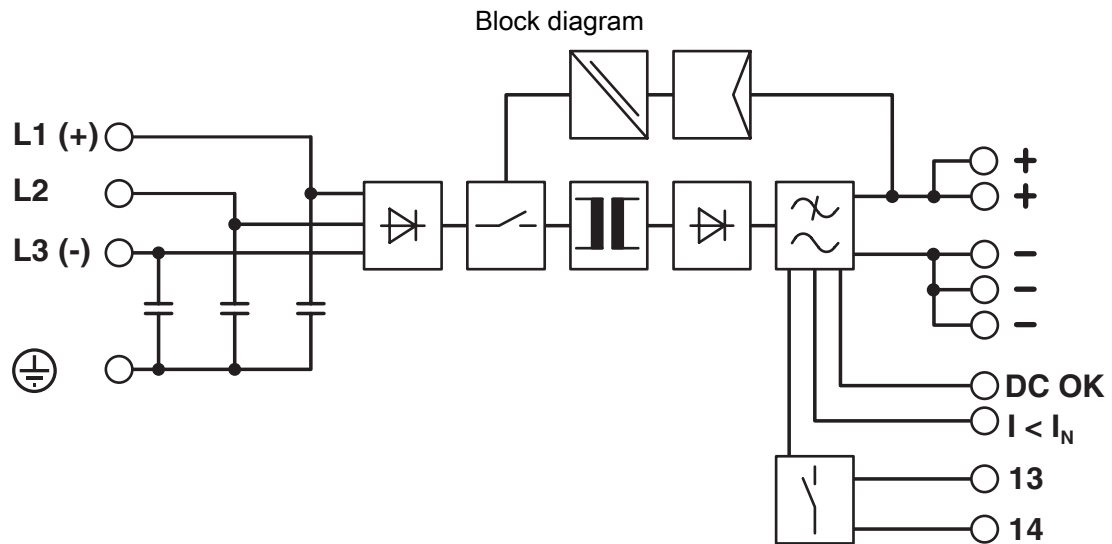

Power supply unit - QUINT-PS/3AC/24DC/40





2866802

<https://www.phoenixcontact.com/us/products/2866802>

Approvals

 **CSA**
Approval ID: 2164434

 **cUL Recognized**
Approval ID: FILE E 211944

 **UL Recognized**
Approval ID: FILE E 211944

 **IECEE CB Scheme**
Approval ID: SI-2973

 **EAC**
Approval ID: EAC-Zulassung

 **DNV GL**
Approval ID: TAA000030X

 **LR**
Approval ID: 08/20069 E4

 **ClassNK** **NK**
Approval ID: TA19643M

 **BV**
Approval ID: 21004-C0 BV

 **EAC**
Approval ID: RU S-DE.BL08.W.00764

 **UL Listed**
Approval ID: FILE E 123528

 **cUL Listed**
Approval ID: FILE E 123528

Power supply unit - QUINT-PS/3AC/24DC/40



2866802

<https://www.phoenixcontact.com/us/products/2866802>



RINA

Approval ID: ELE316517XG

ABS

Approval ID: 20-2022476-PDA



Type approved

Approval ID: SI-SIQ BG 005/009

SEMI F47

Approval ID: SEMI F47



EAC

Approval ID: RU S-DE.BL08.W.00764



cUL Listed

Approval ID: FILE E 199827



UL Listed

Approval ID: FILE E 199827

cULus Recognized

cULus Listed

cULus Listed

Power supply unit - QUINT-PS/3AC/24DC/40



2866802

<https://www.phoenixcontact.com/us/products/2866802>

Classifications

ECLASS

ECLASS-9.0	27040701
ECLASS-10.0.1	27040701
ECLASS-11.0	27040701

ETIM

ETIM 8.0	EC002540
----------	----------

UNSPSC

UNSPSC 21.0	39121000
-------------	----------

Power supply unit - QUINT-PS/3AC/24DC/40



2866802

<https://www.phoenixcontact.com/us/products/2866802>

Environmental Product Compliance

REACH SVHC	Lead 7439-92-1
China RoHS	Environmentally Friendly Use Period = 25; For information on hazardous substances, refer to the manufacturer's declaration available under "Downloads"

Power supply unit - QUINT-PS/3AC/24DC/40



2866802

<https://www.phoenixcontact.com/us/products/2866802>

Accessories

DIN rail adapter

DIN rail adapter - UTA 107 - 2853983

<https://www.phoenixcontact.com/us/products/2853983>

Universal DIN rail adapter, for screwing on switchgear



Mounting adapter

Mounting adapter - UWA 182/52 - 2938235

<https://www.phoenixcontact.com/us/products/2938235>

Universal wall adapter for securely mounting the device in the event of strong vibrations. The device is screwed directly onto the mounting surface. The universal wall adapter is attached on the top/bottom.



Power supply unit - QUINT-PS/3AC/24DC/40



2866802

<https://www.phoenixcontact.com/us/products/2866802>

Redundancy module

Redundancy module - QUINT-DIODE/12-24DC/2X20/1X40 - 2320157

<https://www.phoenixcontact.com/us/products/2320157>



DIN rail diode module 12-24 V DC/2x20 A or 1x40 A. Uniform redundancy up to the consumer.

Redundancy module, with protective coating

Redundancy module, with protective coating - QUINT-ORING/24DC/2X20/1X40 - 2320186

<https://www.phoenixcontact.com/us/products/2320186>



Active QUINT redundancy module for DIN rail mounting with ACB (Auto Current Balancing) Technology and monitoring functions, input: 24 V DC/2x 20 A, output: 24 V DC/1 x 40 A, including mounted UTA 107/30 universal DIN rail adapter

Power supply unit - QUINT-PS/3AC/24DC/40



2866802

<https://www.phoenixcontact.com/us/products/2866802>

Thermomagnetic device circuit breaker

Thermomagnetic device circuit breaker - CB TM1 1A SFB P - 2800836

<https://www.phoenixcontact.com/us/products/2800836>



Thermomagnetic device circuit breaker, 1-pos., tripping characteristic SFB, 1 changeover contact, plug for base element.

Thermomagnetic device circuit breaker

Thermomagnetic device circuit breaker - CB TM1 2A SFB P - 2800837

<https://www.phoenixcontact.com/us/products/2800837>



Thermomagnetic device circuit breaker, 1-pos., tripping characteristic SFB, 1 changeover contact, plug for base element.

Power supply unit - QUINT-PS/3AC/24DC/40



2866802

<https://www.phoenixcontact.com/us/products/2866802>

Thermomagnetic device circuit breaker

Thermomagnetic device circuit breaker - CB TM1 3A SFB P - 2800838

<https://www.phoenixcontact.com/us/products/2800838>



Thermomagnetic device circuit breaker, 1-pos., tripping characteristic SFB, 1 changeover contact, plug for base element.

Thermomagnetic device circuit breaker

Thermomagnetic device circuit breaker - CB TM1 4A SFB P - 2800839

<https://www.phoenixcontact.com/us/products/2800839>



Thermomagnetic device circuit breaker, 1-pos., tripping characteristic SFB, 1 changeover contact, plug for base element.

Power supply unit - QUINT-PS/3AC/24DC/40



2866802

<https://www.phoenixcontact.com/us/products/2866802>

Thermomagnetic device circuit breaker

Thermomagnetic device circuit breaker - CB TM1 5A SFB P - 2800840

<https://www.phoenixcontact.com/us/products/2800840>



Thermomagnetic device circuit breaker, 1-pos., tripping characteristic SFB, 1 changeover contact, plug for base element.

Thermomagnetic device circuit breaker

Thermomagnetic device circuit breaker - CB TM1 6A SFB P - 2800841

<https://www.phoenixcontact.com/us/products/2800841>



Thermomagnetic device circuit breaker, 1-pos., tripping characteristic SFB, 1 changeover contact, plug for base element.

Power supply unit - QUINT-PS/3AC/24DC/40



2866802

<https://www.phoenixcontact.com/us/products/2866802>

Thermomagnetic device circuit breaker

Thermomagnetic device circuit breaker - CB TM1 8A SFB P - 2800842

<https://www.phoenixcontact.com/us/products/2800842>



Thermomagnetic device circuit breaker, 1-pos., tripping characteristic SFB, 1 changeover contact, plug for base element.

Thermomagnetic device circuit breaker

Thermomagnetic device circuit breaker - CB TM1 10A SFB P - 2800843

<https://www.phoenixcontact.com/us/products/2800843>



Thermomagnetic device circuit breaker, 1-pos., tripping characteristic SFB, 1 changeover contact, plug for base element.

Power supply unit - QUINT-PS/3AC/24DC/40



2866802

<https://www.phoenixcontact.com/us/products/2866802>

Thermomagnetic device circuit breaker

Thermomagnetic device circuit breaker - CB TM1 12A SFB P - 2800844

<https://www.phoenixcontact.com/us/products/2800844>



Thermomagnetic device circuit breaker, 1-pos., tripping characteristic SFB, 1 changeover contact, plug for base element.

Thermomagnetic device circuit breaker

Thermomagnetic device circuit breaker - CB TM1 16A SFB P - 2800845

<https://www.phoenixcontact.com/us/products/2800845>



Thermomagnetic device circuit breaker, 1-pos., tripping characteristic SFB, 1 changeover contact, plug for base element.

Power supply unit - QUINT-PS/3AC/24DC/40



2866802

<https://www.phoenixcontact.com/us/products/2866802>

Type 3 surge protection device

Type 3 surge protection device - PLT-SEC-T3-3S-230-FM - 2905230

<https://www.phoenixcontact.com/us/products/2905230>

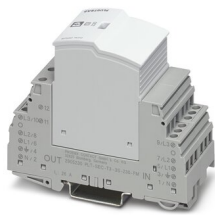

Plug-in device protection, according to type 3/class III, for 3-phase power supply networks with separate N and PE (5-conductor system: L1, L2, L3, N, PE), with integrated surge-proof fuse and remote indication contact.

Type 3 surge protection device

Type 3 surge protection device - PLT-SEC-T3-24-FM-UT - 2907916

<https://www.phoenixcontact.com/us/products/2907916>



Type 3 surge protection, consisting of protective plug and base element, with integrated status indicator and remote signaling for single-phase power supply networks. Nominal voltage: 24 V AC/DC

Power supply unit - QUINT-PS/3AC/24DC/40



2866802

<https://www.phoenixcontact.com/us/products/2866802>

End clamp

End clamp - E/AL-NS 35 - 1201662

<https://www.phoenixcontact.com/us/products/1201662>

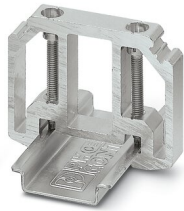

End clamp, for end support of UKH 50 to UKH 240, is pushed onto DIN rail NS 35 and fixed with 2 screws, width: 10 mm, color: aluminum

Phoenix Contact 2022 © - all rights reserved

<https://www.phoenixcontact.com>

Phoenix Contact USA
586 Fulling Mill Road
Middletown, PA 17057, United States
(+717) 944-1300
info@phoenixcon.com