

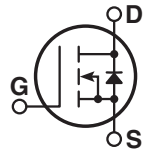

## Super Junction MOSFET

- Ultra Low  $R_{DS(ON)}$
- Low Miller Capacitance
- Ultra Low Gate Charge,  $Q_g$
- Avalanche Energy Rated
- Extreme  $dv/dt$  Rated
- Popular TO-247 or Surface Mount D<sup>3</sup> package.

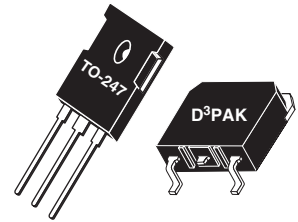

### MAXIMUM RATINGS

All Ratings per die:  $T_C = 25^\circ\text{C}$  unless otherwise specified.

Symbol	Parameter	APT77N60B_SC6	UNIT
$V_{DSS}$	Drain-Source Voltage	600	Volts
$I_D$	Continuous Drain Current @ $T_C = 25^\circ\text{C}$	77	Amps
	Continuous Drain Current @ $T_C = 100^\circ\text{C}$	49	
$I_{DM}$	Pulsed Drain Current <sup>1</sup>	272	
$V_{GS}$	Gate-Source Voltage Continuous	$\pm 20$	Volts
$P_D$	Total Power Dissipation @ $T_C = 25^\circ\text{C}$	481	Watts
$T_J, T_{STG}$	Operating and Storage Junction Temperature Range	- 55 to 150	$^\circ\text{C}$
$T_L$	Lead Temperature: 0.063" from Case for 10 Sec.	300	
$I_{AR}$	Avalanche Current <sup>2</sup>	13.4	Amps
$E_{AR}$	Repetitive Avalanche Energy <sup>2</sup> ( $I_D = 13.4\text{A}, V_{DD} = 50\text{V}$ )	2.96	mJ
$E_{AS}$	Single Pulse Avalanche Energy ( $I_D = 13.4\text{A}, V_{DD} = 50\text{V}$ )	1954	

### STATIC ELECTRICAL CHARACTERISTICS

Symbol	Characteristic / Test Conditions	MIN	TYP	MAX	UNIT
$BV_{(DSS)}$	Drain-Source Breakdown Voltage ( $V_{GS} = 0\text{V}, I_D = 250\mu\text{A}$ )	600			Volts
$R_{DS(on)}$	Drain-Source On-State Resistance <sup>3</sup> ( $V_{GS} = 10\text{V}, I_D = 44.4\text{A}$ )		.037	.041	Ohms
$I_{DSS}$	Zero Gate Voltage Drain Current ( $V_{DS} = V_{DSS}, V_{GS} = 0\text{V}, T_C = 25^\circ\text{C}$ )			25	$\mu\text{A}$
	Zero Gate Voltage Drain Current ( $V_{DS} = V_{DSS}, V_{GS} = 0\text{V}, T_C = 150^\circ\text{C}$ )			250	
$I_{GSS}$	Gate-Source Leakage Current ( $V_{GS} = \pm 20\text{V}, V_{DS} = 0\text{V}$ )			$\pm 100$	nA
$V_{GS(th)}$	Gate Threshold Voltage ( $V_{DS} = V_{GS}, I_D = 2.96\text{mA}$ )	2.5	3	3.6	Volts



CAUTION: These Devices are Sensitive to Electrostatic Discharge. Proper Handling Procedures Should Be Followed.

"COOLMOS™ comprise a new family of transistors developed by Infineon Technologies AG. "COOLMOS" is a trademark of Infineon Technologies AG."

Microsemi Website - <http://www.microsemi.com>

Symbol	Characteristic	Test Conditions	MIN	TYP	MAX	UNIT
C <sub>iss</sub>	Input Capacitance	V <sub>GS</sub> = 0V V <sub>DS</sub> = 25V f = 1 MHz		13600		pF
C <sub>oss</sub>	Output Capacitance			4400		
C <sub>rss</sub>	Reverse Transfer Capacitance			290		
Q <sub>g</sub>	Total Gate Charge <sup>4</sup>	V <sub>GS</sub> = 10V V <sub>DD</sub> = 400V I <sub>D</sub> = 77A @ 25°C		260		nC
Q <sub>gs</sub>	Gate-Source Charge			38		
Q <sub>gd</sub>	Gate-Drain ("Miller") Charge			144		
t <sub>d(on)</sub>	Turn-on Delay Time	<b>INDUCTIVE SWITCHING</b> V <sub>GS</sub> = 10V V <sub>DD</sub> = 380V I <sub>D</sub> = 77A @ 25°C R <sub>G</sub> = 5.0Ω		18		ns
t <sub>r</sub>	Rise Time			27		
t <sub>d(off)</sub>	Turn-off Delay Time			110	165	
t <sub>f</sub>	Fall Time			8	12	
E <sub>on</sub>	Turn-on Switching Energy <sup>5</sup>	<b>INDUCTIVE SWITCHING @ 25°C</b> V <sub>DD</sub> = 400V, V <sub>GS</sub> = 15V I <sub>D</sub> = 77A, R <sub>G</sub> = 5Ω		1670		μJ
E <sub>off</sub>	Turn-off Switching Energy			2880		
E <sub>on</sub>	Turn-on Switching Energy <sup>5</sup>	<b>INDUCTIVE SWITCHING @ 125°C</b> V <sub>DD</sub> = 400V, V <sub>GS</sub> = 15V I <sub>D</sub> = 77A, R <sub>G</sub> = 5Ω		2300		
E <sub>off</sub>	Turn-off Switching Energy			3100		

SOURCE-DRAIN DIODE RATINGS AND CHARACTERISTICS

Symbol	Characteristic / Test Conditions	MIN	TYP	MAX	UNIT
I <sub>S</sub>	Continuous Source Current (Body Diode)			77	Amps
I <sub>SM</sub>	Pulsed Source Current <sup>1</sup> (Body Diode)			231	
V <sub>SD</sub>	Diode Forward Voltage <sup>3</sup> (V <sub>GS</sub> = 0V, I <sub>S</sub> = -77A)		1	1.2	Volts
dv/dt	Peak Diode Recovery <sup>dv/dt</sup> <sup>6</sup>			15	V/ns
t <sub>rr</sub>	Reverse Recovery Time (I <sub>S</sub> = -77A, di/dt = 100A/μs)	T <sub>J</sub> = 25°C	950		ns
Q <sub>rr</sub>	Reverse Recovery Charge (I <sub>S</sub> = -77A, di/dt = 100A/μs)	T <sub>J</sub> = 25°C	32		μC
I <sub>RRM</sub>	Peak Recovery Current (I <sub>S</sub> = -77A, di/dt = 100A/μs)	T <sub>J</sub> = 25°C	60		Amps

THERMAL CHARACTERISTICS

Symbol	Characteristic	MIN	TYP	MAX	UNIT
R <sub>θJC</sub>	Junction to Case			0.26	°C/W
R <sub>θJA</sub>	Junction to Ambient			40	

1 Repetitive Rating: Pulse width limited by maximum junction temperature

4 See MIL-STD-750 Method 3471

2 Repetitive avalanche causes additional power losses that can be calculated as

5 Eon includes diode reverse recovery.

$P_{AV} = E_{AR} \cdot f$ . Pulse width tp limited by Tj max.

6 Maximum 125°C diode commutation speed = di/dt 600A/μs

3 Pulse Test: Pulse width < 380 μs, Duty Cycle < 2%

Microsemi reserves the right to change, without notice, the specifications and information contained herein.

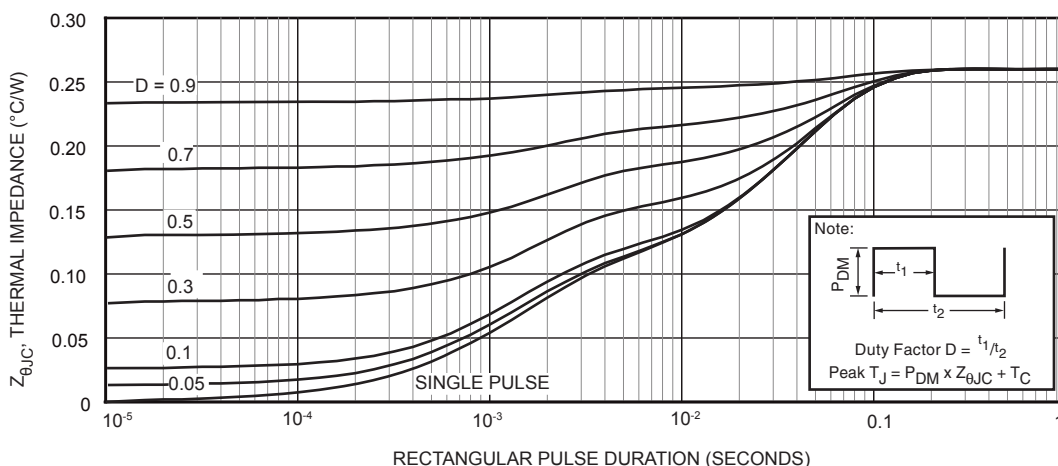

Figure 1, Maximum Effective Transient Thermal Impedance, Junction-To-Case vs Pulse Duration

# Typical Performance Curves

APT77N60B\_SC6

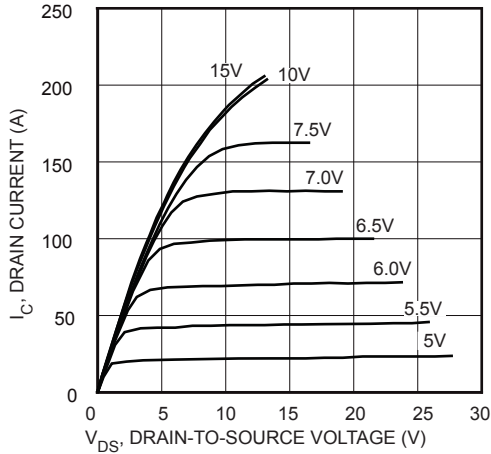

FIGURE 2, Low Voltage Output Characteristics

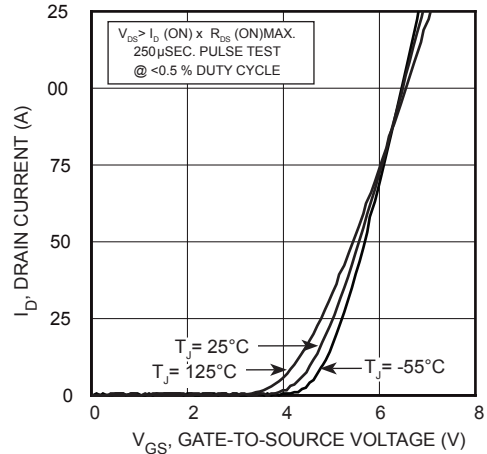

FIGURE 3, Transfer Characteristics

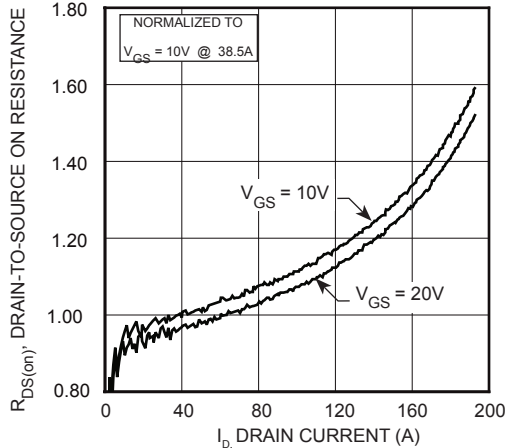

FIGURE 4,  $R_{DS(ON)}$  vs Drain Current

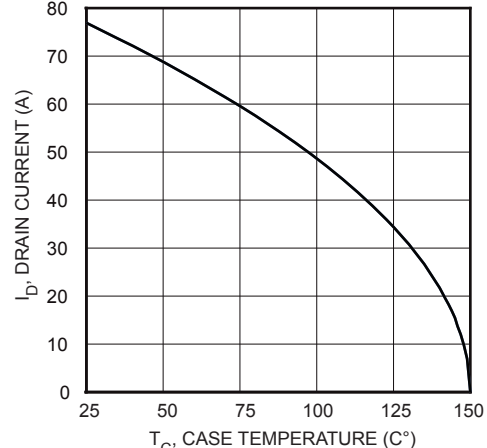

FIGURE 5, Maximum Drain Current vs Case Temperature

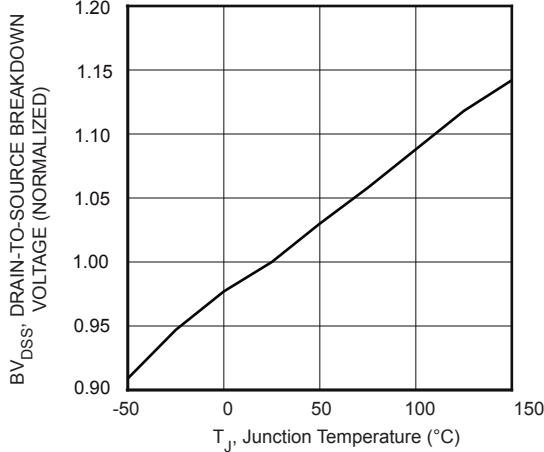

FIGURE 6, Breakdown Voltage vs Temperature

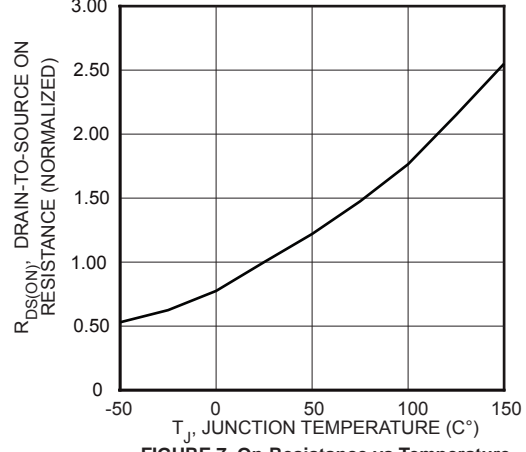

FIGURE 7, On-Resistance vs Temperature

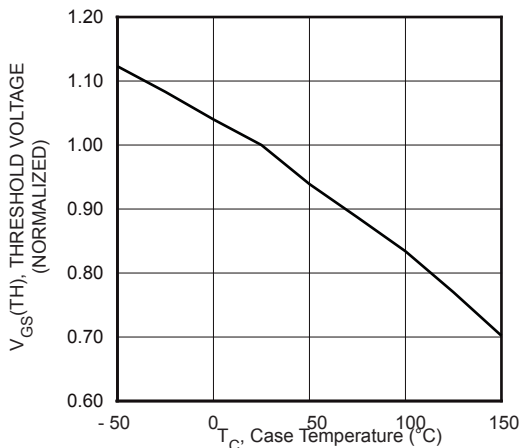

FIGURE 8, Threshold Voltage vs Temperature

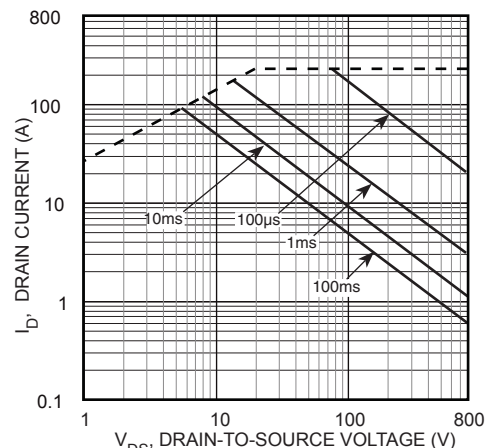

FIGURE 9, Maximum Safe Operating Area

# Typical Performance Curves

APT77N60B\_SC6

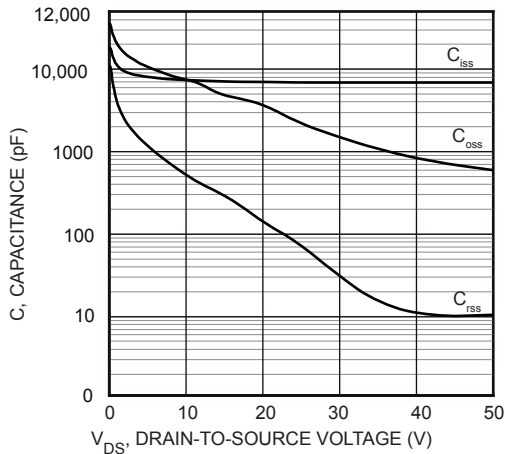

FIGURE 10, Capacitance vs Drain-To-Source Voltage

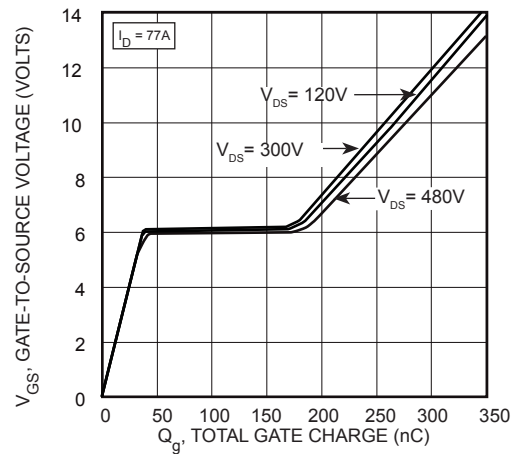

FIGURE 11, Gate Charges vs Gate-To-Source Voltage

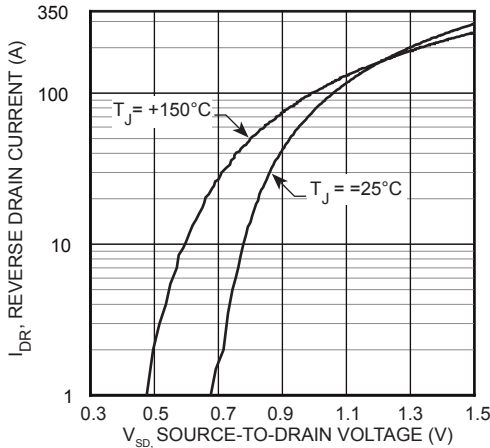

FIGURE 12, Source-Drain Diode Forward Voltage

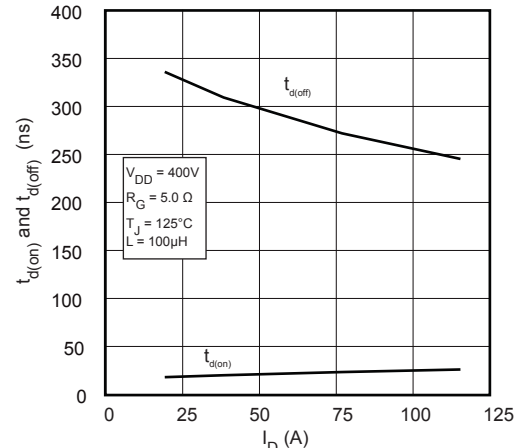

FIGURE 13, Delay Times vs Current

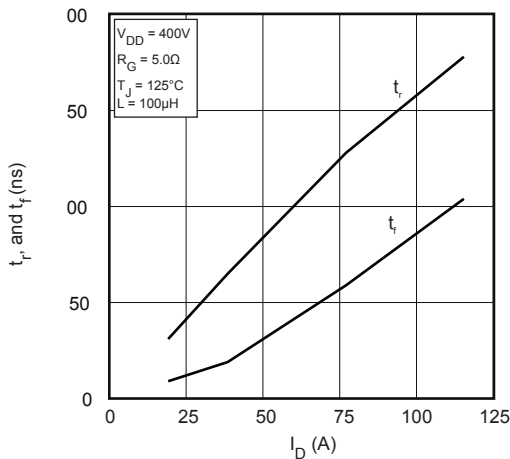

FIGURE 14, Rise and Fall Times vs Current

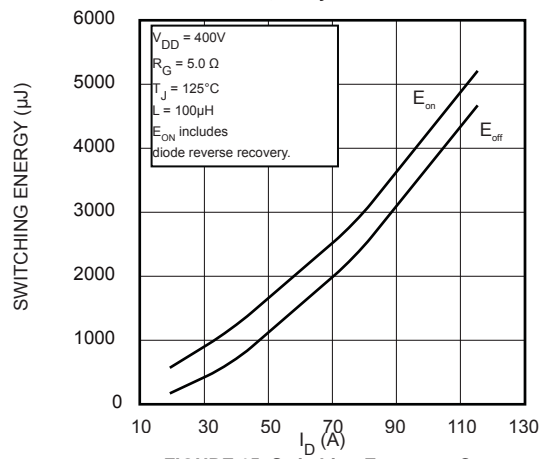

FIGURE 15, Switching Energy vs Current

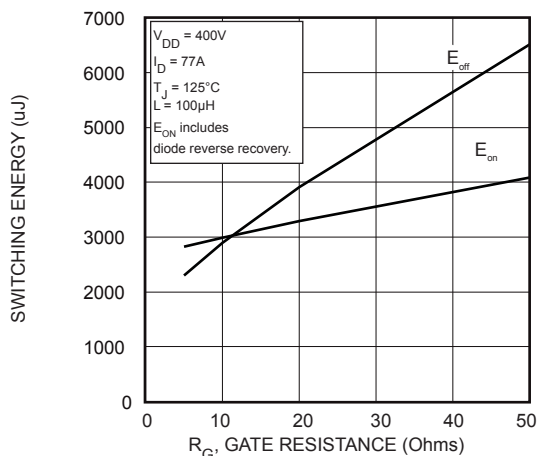

FIGURE 16, Switching Energy vs Gate Resistance

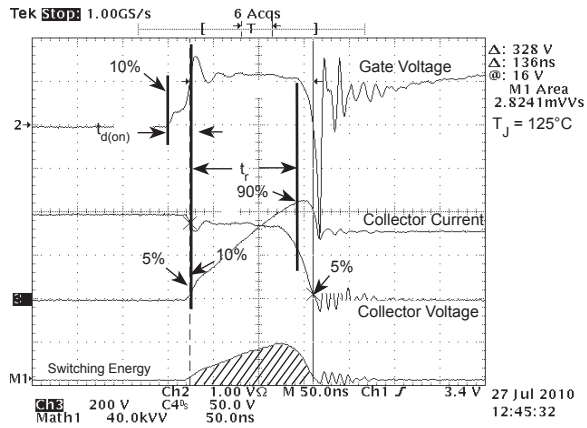

Figure 17, Turn-on Switching Waveforms and Definitions

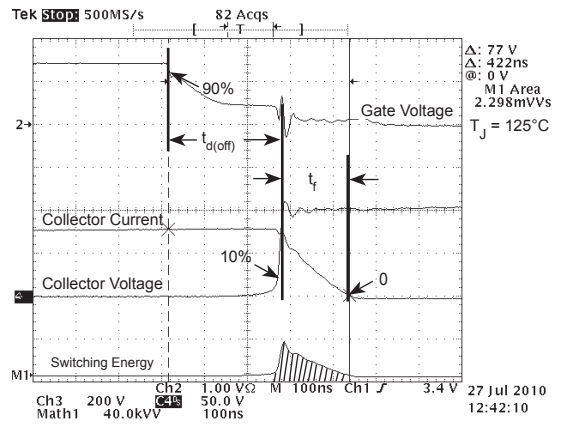

Figure 18, Turn-off Switching Waveforms and Definitions

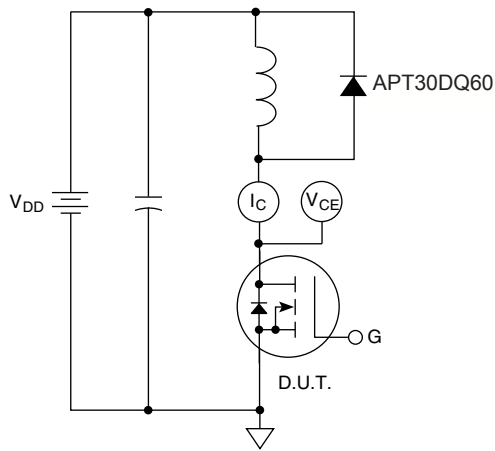
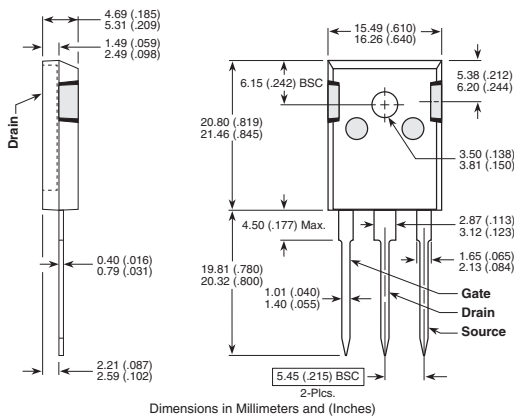

Figure 19, Inductive Switching Test Circuit

TO-247 Package Outline



D<sup>3</sup>PAK Package Outline

Ⓢ 100% Sn

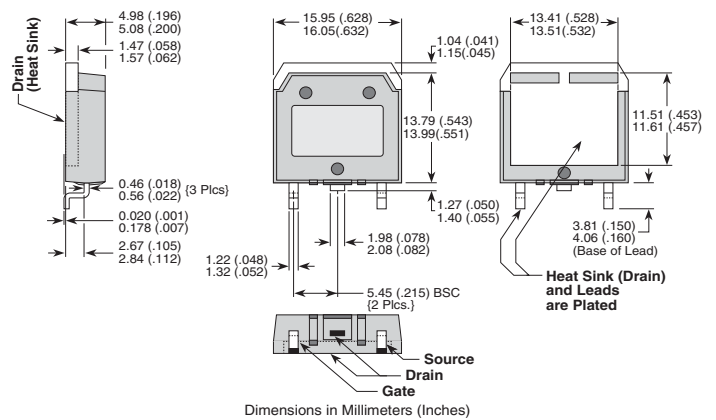

# Mouser Electronics

Authorized Distributor

Click to View Pricing, Inventory, Delivery & Lifecycle Information:

[Microsemi:](#)

[APT77N60SC6](#)