



VOIDLESS HERMETICALLY SEALED SURFACE MOUNT 1.5 WATT GLASS ZENER DIODES
Qualified per MIL-PRF-19500/406

*Qualified Levels:
JAN, JANTX,
JANTXV and JANS*

DESCRIPTION

This surface mount, Zener voltage regulator series is military qualified to MIL-PRF-19500/406 and is ideal for high-reliability applications where a failure cannot be tolerated. These industry-recognized 1.5 watt Zener voltage regulators are hermetically sealed with void-less glass construction using an internal metallurgical bond. It includes Zener selections from 3.3 to 200 volts in standard 5% tolerance. 1% and 2% tolerance versions are also available. Microsemi also offers numerous other Zener products to meet higher and lower power ratings in both thru-hole and surface mount packages.

Important: For the latest information, visit our website <http://www.microsemi.com>.

FEATURES

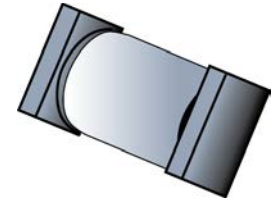
- Surface mount equivalent of popular JEDEC registered series.
- Void-less hermetically sealed glass package.
- Triple-layer passivation.
- Extremely robust construction.
- Internal “Category 1” metallurgical bonds for 1N4462US thru 1N4496US and “Category III” for 1N6485US thru 1N6491US as well as 1N4460US and 1N4461US.
- JAN, JANTX, JANTXV and JANS qualifications are available per MIL-PRF-19500/406.
- RoHS compliant versions available (commercial grade only).

APPLICATIONS / BENEFITS

- Regulates voltage over a broad operating current and temperature range.
- Extensive selection from 3.3 to 200 V.
- Standard voltage tolerances are plus/minus 5% with no suffix.
- Tighter tolerances available in plus or minus 2% or 1%.
- Non-sensitive to ESD per MIL-STD-750 method 1020.
- Inherently radiation hard as described in Microsemi [MicroNote 050](#).


MAXIMUM RATINGS @ T_A = 25 °C unless otherwise specified

Parameters/Test Conditions	Symbol	Value	Unit
Junction and Storage Temperature	T _J & T _{STG}	-65 to +175	°C
Steady State Power Dissipation @ T _A = 25 °C	P _D	1.5	W
Thermal Resistance Junction-to-End Cap	R _{ΘJEC}	20	°C/W
Thermal Impedance @ 10 ms	Z _{ΘJX}	Figure 3 Figure 4 Figure 4	°C/W
Forward Voltage @ 200 mA	V _F	1.0	V
@ 1.0 A		1.5	
Solder Temperature @ 10 s	T _{SP}	260	°C



“A” (D-5A) MELF Package

Also available in:

 **DO-41 Package**
(axial-lead)
[1N4460 – 1N4496 and](#)
[1N6485 – 1N6491](#)

MSC – Lawrence

6 Lake Street,
Lawrence, MA 01841
Tel: 1-800-446-1158 or
(978) 620-2600
Fax: (978) 689-0803

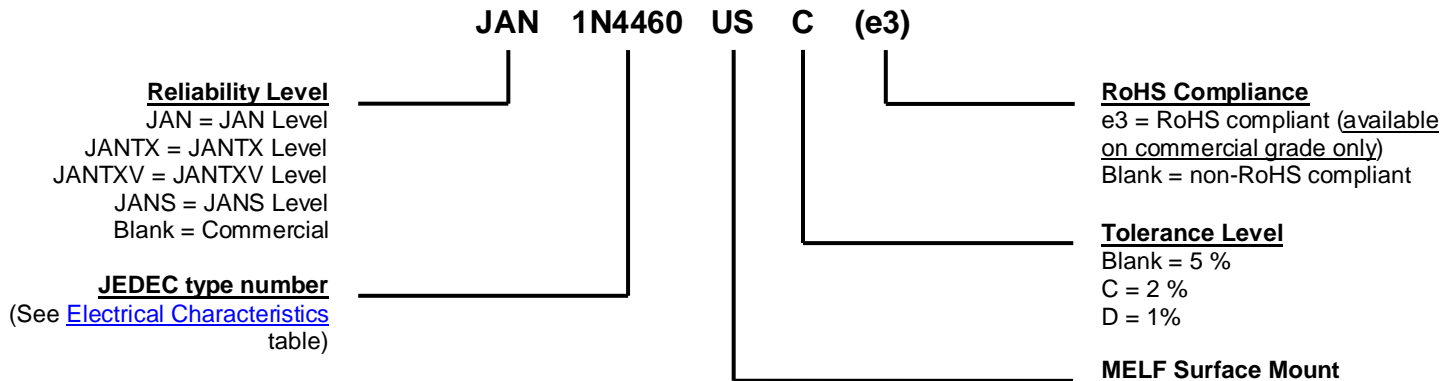
MSC – Ireland

Gort Road Business Park,
Ennis, Co. Clare, Ireland
Tel: +353 (0) 65 6840044
Fax: +353 (0) 65 6822298

Website:
www.microsemi.com

MECHANICAL and PACKAGING

- CASE: Hermetically sealed voidless hard glass with tungsten slugs.
- TERMINALS: Tin/lead (Sn/Pb) or RoHS compliant matte/tin (commercial grade only) over copper.
- MARKING: Polarity band only.
- POLARITY: Cathode indicated by band.
- TAPE & REEL option: Standard per EIA-481-B. Consult factory for quantities.
- WEIGHT: 193 milligrams.
- See [Package Dimensions](#) on last page.

PART NOMENCLATURE

SYMBOLS & DEFINITIONS

Symbol	Definition
V_Z	Zener Voltage: The Zener voltage the device will exhibit at a specified current (I_Z) in its breakdown region.
I_Z, I_{ZT}, I_{ZK}	Regulator Current: The dc regulator current (I_Z), at a specified test point (I_{ZT}), near breakdown knee (I_{ZK}).
Z_{ZT} or Z_{ZK}	Dynamic Impedance: The small signal impedance of the diode when biased to operate in its breakdown region at a specified rms current modulation (typically 10% of I_{ZT} or I_{ZK}) and superimposed on I_{ZT} or I_{ZK} respectively.
V_F	Maximum Forward Voltage: The maximum forward voltage the device will exhibit at a specified current.
I_R	Maximum Reverse Current: The maximum reverse (leakage) current that will flow at the specified voltage and temperature.
I_{ZM}	Maximum Regulator (Zener) Current: The maximum rated dc current for the specified power rating.
I_{ZSM}	Maximum Zener Surge Current: The non-repetitive peak value of Zener surge current at a specified wave form.

ELECTRICAL CHARACTERISTICS @ 25 °C Case temperature

TYPE	NOMINAL ZENER VOLTAGE V_Z	TEST CURRENT I_{ZT}	MAXIMUM DYNAMIC IMPEDANCE $Z_{ZT} @ I_{ZT}$	MAXIMUM KNEE IMPEDANCE $Z_{ZK} @ I_{ZK}$		MAXIMUM REVERSE CURRENT $I_R @ V_R$		MAXIMUM CONTINUOUS CURRENT I_{ZM} (Note 1)	SURGE CURRENT @ 8.3 ms square wave I_{ZSM}
	Volts	mA	Ohms	Ohms	mA	μA	Volts	mA	Amps
1N4460US	6.2	40.0	4	200	1.0	10.0	3.72	230	2.3
1N4461US	6.8	37.0	2.5	200	1.0	5.0	4.08	210	2.1
1N4462US	7.5	34.0	2.5	400	.5	1.0	4.50	191	1.9
1N4463US	8.2	31.0	3	400	.5	.50	4.92	174	1.7
1N4464US	9.1	28.0	4	500	.5	.30	5.46	157	1.6
1N4465US	10.0	25.0	5	500	.25	.30	8.00	143	1.4
1N4466US	11.0	23.0	6	550	.25	.30	8.80	130	1.3
1N4467US	12.0	21.0	7	550	.25	.20	9.60	119	1.2
1N4468US	13.0	19.0	8	550	.25	.05	10.4	110	1.1
1N4469US	15.0	17.0	9	600	.25	.05	12.0	95	.95
1N4470US	16.0	15.5	10	600	.25	.05	12.8	90	.90
1N4471US	18.0	14.0	11	650	.25	.05	14.4	79	.79
1N4472US	20.0	12.5	12	650	.25	.05	16.0	71	.71
1N4473US	22.0	11.5	14	650	.25	.05	17.6	65	.65
1N4474US	24.0	10.5	16	700	.25	.05	19.2	60	.60
1N4475US	27.0	9.5	18	700	.25	.05	21.6	53	.53
1N4476US	30.0	8.5	20	750	.25	.05	24.0	48	.48
1N4477US	33.0	7.5	25	800	.25	.05	26.4	43	.43
1N4478US	36.0	7.0	27	850	.25	.05	28.8	40	.40
1N4479US	39.0	6.5	30	900	.25	.05	31.2	37	.37
1N4480US	43.0	6.0	40	950	.25	.05	34.4	33	.33
1N4481US	47.0	5.5	50	1000	.25	.05	37.6	30	.30
1N4482US	51.0	5.0	60	1100	.25	.05	40.8	28	.28
1N4483US	56.0	4.5	70	1300	.25	.25	44.8	26	.26
1N4484US	62.0	4.0	80	1500	.25	.25	49.6	23	.23
1N4485US	68.0	3.7	100	1700	.25	.25	54.4	21	.21
1N4486US	75.0	3.3	130	2000	.25	.25	60.0	19	.19
1N4487US	82.0	3.0	160	2500	.25	.25	65.6	17	.17
1N4488US	91.0	2.8	200	3000	.25	.25	72.8	16	.16
1N4489US	100.0	2.5	250	3100	.25	.25	80.0	14	.14
1N4490US	110.0	2.3	300	4000	.25	.25	88.0	13	.13
1N4491US	120.0	2.0	400	4500	.25	.25	96.0	12	.12
1N4492US	130.0	1.9	500	5000	.25	.25	104.0	11	.11
1N4493US	150.0	1.7	700	6000	.25	.25	120.0	9.5	.095
1N4494US	160.0	1.6	1000	6500	.25	.25	128.0	8.9	.089
1N4495US	180.0	1.4	1300	7000	.25	.25	144.0	7.9	.079
1N4496US	200.0	1.2	1500	8000	.25	.25	160.0	7.2	.072
1N6485US	3.3	76.0	10	400	1.0	50	1.0	433	4.2
1N6486US	3.6	69.0	10	400	1.0	50	1.0	397	3.9
1N6487US	3.9	64.0	9	400	1.0	35	1.0	366	3.6
1N6488US	4.3	58.0	9	400	1.0	5.0	1.0	332	3.3
1N6489US	4.7	53.0	8	500	1.0	4.0	1.0	304	3.0
1N6490US	5.1	49.0	7	500	1.0	1.0	1.0	280	2.7
1N6491US	5.6	45.0	5	600	1.0	0.5	2.0	255	2.5

NOTE: 1. See "[Maximum Ratings](#)" for P_D temperature conditions for end-cap package where I_{ZM} is applicable.

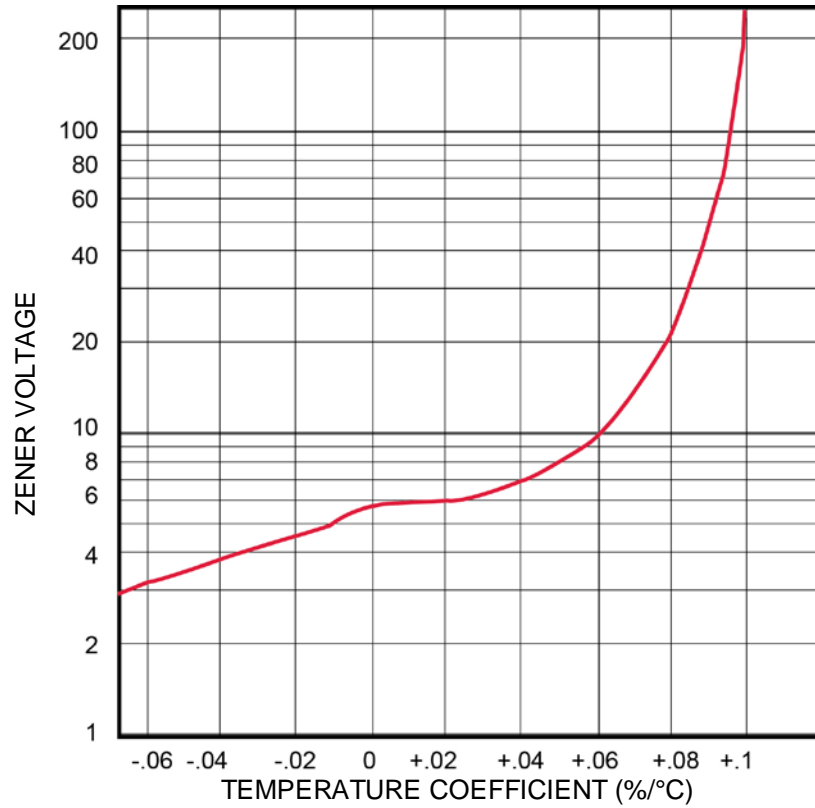
GRAPHS


FIGURE 1
Temperature Coefficient Characteristics

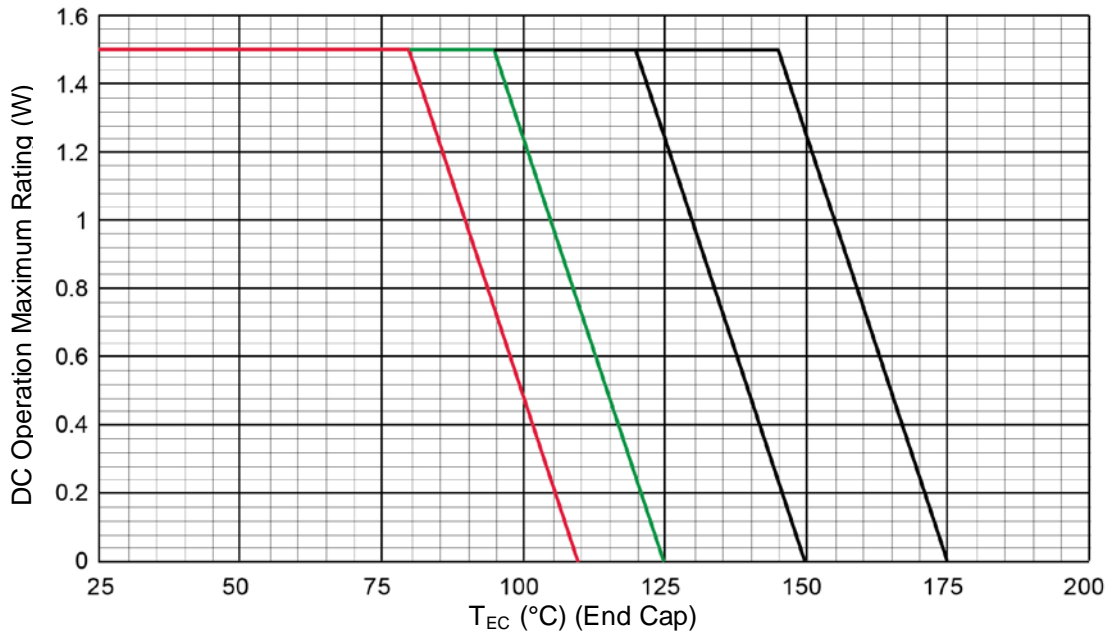


FIGURE 2
Temperature-Power Derating Curve

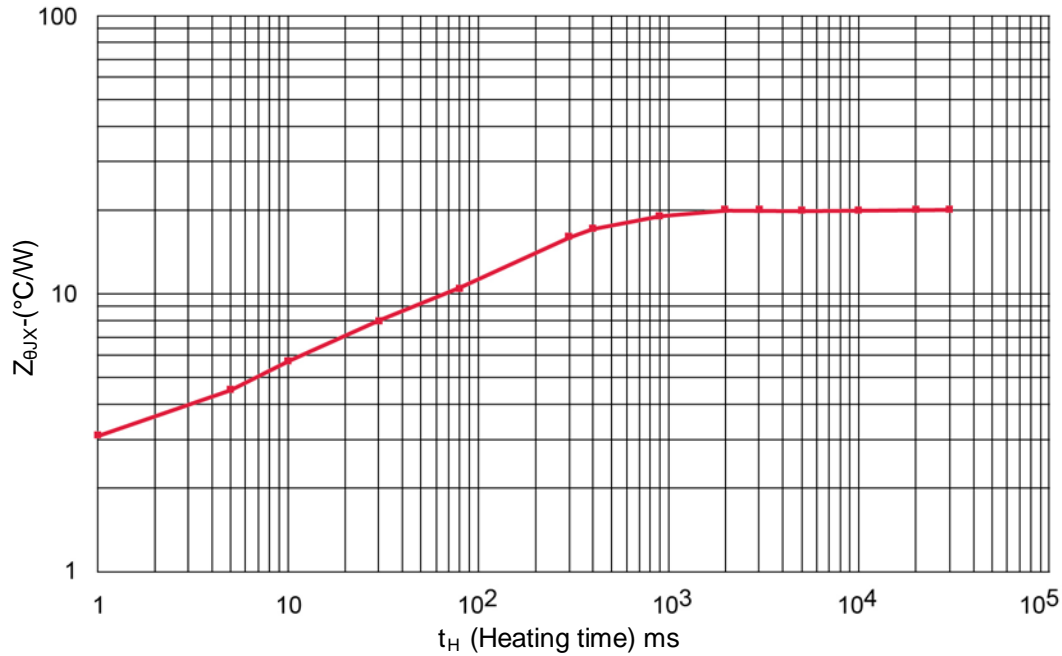
GRAPHS (continued)


FIGURE 3
Thermal Impedance Curve for 1N4462US through 1N4496US

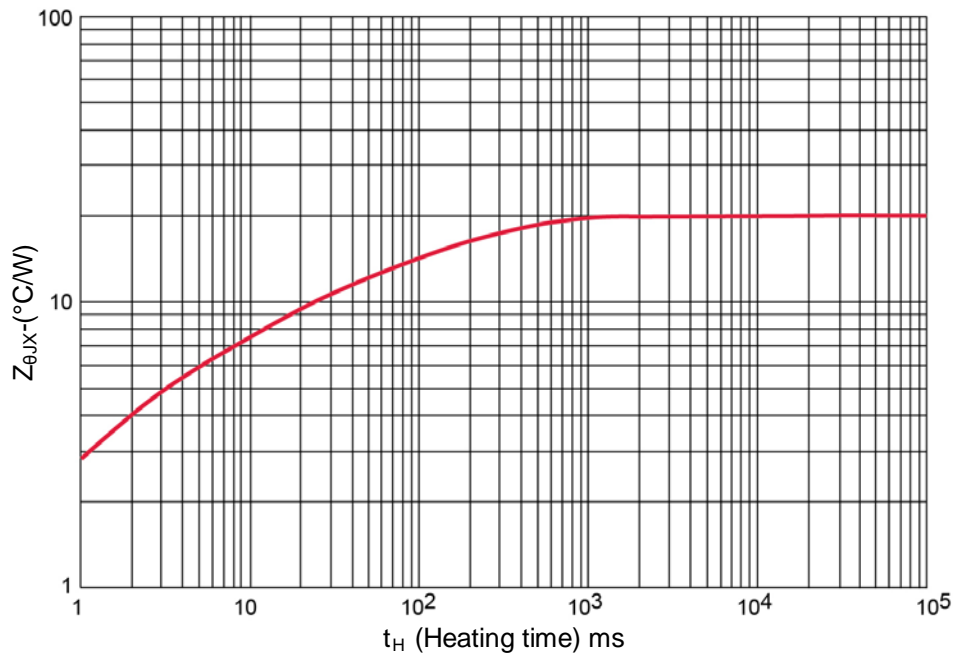
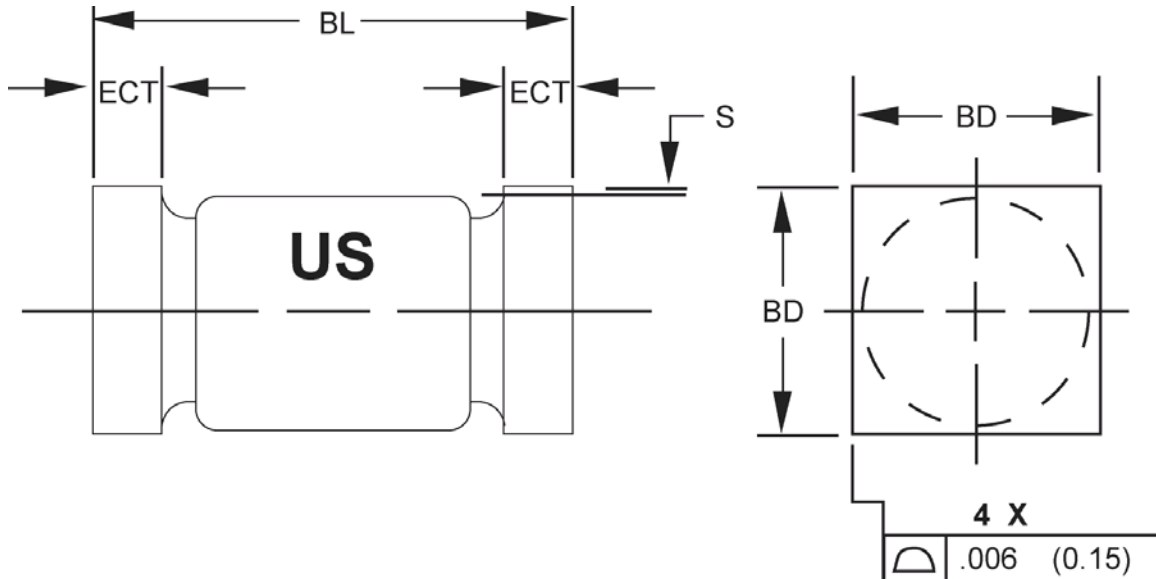
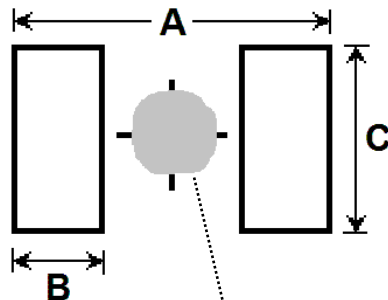


FIGURE 4
Thermal Impedance Curve for 1N6485US through 1N6491US and 1N4460US through 1N4461US

PACKAGE DIMENSIONS

NOTES:

1. Dimensions are in inches.
2. Millimeters are given for general information only.
3. Dimensions are pre-solder dip.
4. In accordance with ASME Y14.5M, diameters are equivalent to Φ x symbology.

Ltr	DIMENSIONS			
	INCH		MILLIMETERS	
	Min	Max	Min	Max
BD	.091	.103	2.31	2.62
BL	.168	.200	4.28	5.08
ECT	.019	.028	0.48	0.71
S	.003		0.08	

PAD LAYOUT


DIM	INCH	MILLIMETERS
A	0.288	7.32
B	0.070	1.78
C	0.155	3.94

NOTE: If mounting requires adhesive separate from the solder, an additional 0.080 inch diameter contact may be placed in the center between the pads as an optional spot for cement.

Mouser Electronics

Authorized Distributor

Click to View Pricing, Inventory, Delivery & Lifecycle Information:

Microsemi:

[1N4468US](#) [1N4466US](#) [1N4469US](#) [1N4471US](#) [JANTX1N4469US](#) [1N4467US](#) [1N4464US](#) [1N4493US](#) [1N4482US](#)
[1N4462US](#) [1N4489US](#) [1N4476US](#) [1N4461US](#) [1N6490US](#) [1N6491US](#) [1N4470US](#) [1N4463US](#) [1N4473US](#)
[1N4486US](#) [1N4488US](#) [1N4472US](#) [1N4460US](#) [1N4495US](#) [1N4484US](#) [1N4481US](#) [1N6487US](#) [1N6486US](#)
[1N4478US](#) [1N4496US](#) [1N4477US](#) [1N4483US](#) [1N4485US](#) [1N4494US](#) [1N4487US](#) [1N4475US](#) [1N4490US](#)
[1N4479US](#) [1N6485US](#) [1N4474US](#) [1N4491US](#) [1N4492US](#) [1N4480US](#) [1N4465US](#) [1N6488US](#) [1N6489US](#)