



Micro Commercial Components



Micro Commercial Components  
 20736 Marilla Street Chatsworth  
 CA 91311  
 Phone: (818) 701-4933  
 Fax: (818) 701-4939

# BC846A THRU BC849C

## NPN Plastic-Encapsulate Transistors

### Features

- Lead Free Finish/RoHS Compliant ("P" Suffix designates RoHS Compliant. See ordering information)
- Power Dissipation: 0.225W ( $T_{amb}=25^{\circ}C$ )(Note 1)
- Collector Current: 0.1A
- Epoxy meets UL 94 V-0 flammability rating
- Moisture Sensitivity Level 1
- Halogen free available upon request by adding suffix "-HF"

### Maximum Ratings

- Operating temperature :  $-55^{\circ}C$  to  $+150^{\circ}C$
- Storage temperature :  $-55^{\circ}C$  to  $+150^{\circ}C$

### DEVICE MARKING

BC846A=1A,46A; BC846B=1B,46B;  
 BC847A=1E,47A; BC847B=1F,47B; BC847C=1G,47C;  
 BC848A=1J,48A; BC848B=1K,48B; BC848C=1L,48C  
 BC849B=49B; BC849C=49C;

### Electrical Characteristics @ 25°C Unless Otherwise Specified

Symbol	Parameter	Min	Max	Units
--------	-----------	-----	-----	-------

### OFF CHARACTERISTICS

$V_{(BR)CBO}$	Collector-Base Breakdown Voltage ( $I_C=10\mu A$ , $I_E=0$ )			Vdc
	BC846	80	---	
	BC847 BC848, BC849	50 30	---	
$V_{(BR)CEO}$	Collector-Emitter Breakdown Voltage ( $I_C=10mA$ , $I_B=0$ )			Vdc
	BC846	65	---	
	BC847 BC848, BC849	45 30	---	
$V_{(BR)EBO}$	Collector-Emitter Breakdown Voltage ( $I_E=10\mu A$ , $I_C=0$ )	6	---	Vdc
$I_{CBO}$	Collector Cut-off Current ( $V_{CB}=70V$ , $I_E=0$ )	---	0.1	$\mu A$
	BC847 ( $V_{CB}=50V$ , $I_E=0$ )			
	BC848, BC849 ( $V_{CB}=30V$ , $I_E=0$ )			
$I_{CEO}$	Collector Cut-off Current ( $V_{CE}=60V$ , $I_B=0$ )	---	0.1	$\mu A$
	BC847 ( $V_{CE}=45V$ , $I_B=0$ )			
	BC848, BC849 ( $V_{CE}=30V$ , $I_B=0$ )			
$I_{EBO}$	Emitter Cut-off Current ( $V_{EB}=5V$ , $I_C=0mA$ )	---	0.1	$\mu A$
$H_{FE(1)}$	DC Current Gain ( $V_{CE}=5V$ , $I_C=2mA$ )			
	BC846A, 847A, 848A	110	220	
	BC846B, 847B, 848B, 849B BC847C, BC848C, BC849C	200 420	450 800	
$V_{CE(sat)}$	Collector-Emitter Saturation Voltage ( $I_C=100mA$ , $I_B=5mA$ )	---	0.5	Vdc
$V_{BE(sat)}$	Base-Emitter Saturation Voltage ( $I_C=100mA$ , $I_B=5mA$ )	---	1.1	Vdc
$f_T$	Transition Frequency ( $V_{CE}=5V$ , $I_C=10mA$ , $f=100MHz$ )	100	---	MHz

Note 1: Transistor mounted on an FR4 printed-circuit board

### SOT-23

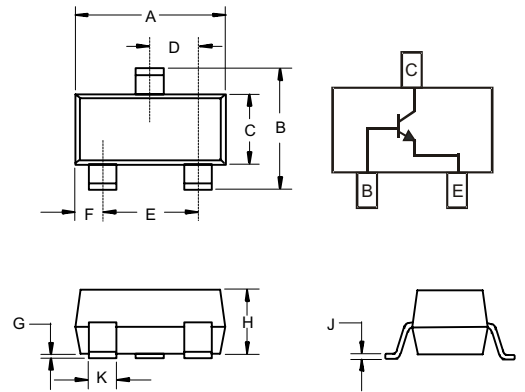

DIM	INCHES		MM		NOTE
	MIN	MAX	MIN	MAX	
A	.110	.120	2.80	3.04	
B	.083	.104	2.10	2.64	
C	.047	.055	1.20	1.40	
D	.035	.041	.89	1.03	
E	.070	.081	1.78	2.05	
F	.018	.024	.45	.60	
G	.0005	.0039	.013	.100	
H	.035	.044	.89	1.12	
J	.003	.007	.085	.180	
K	.015	.020	.37	.51	

### Suggested Solder Pad Layout

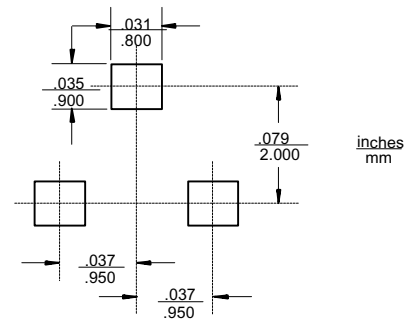

# BC846A thru BC849C

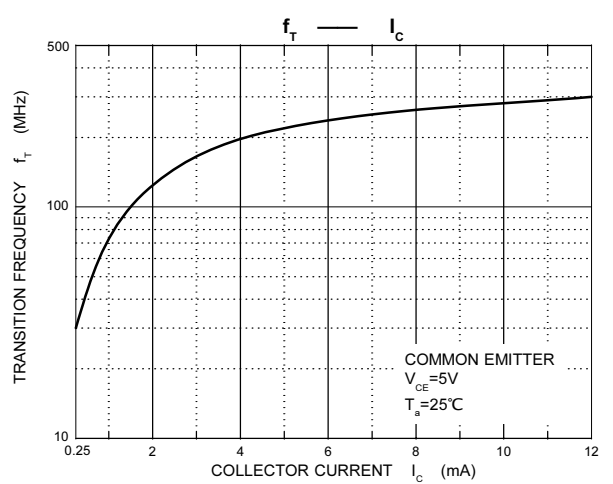
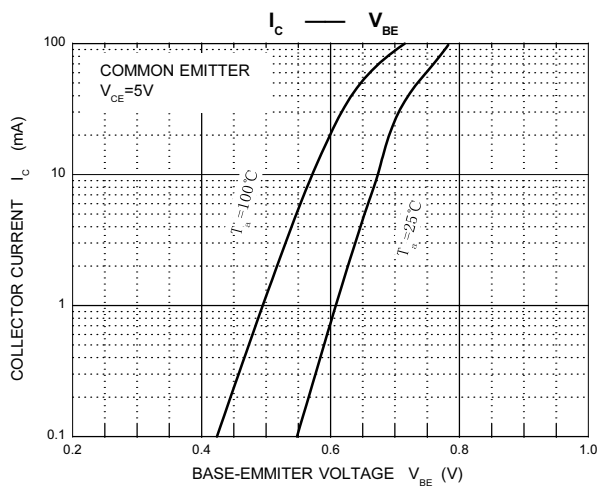
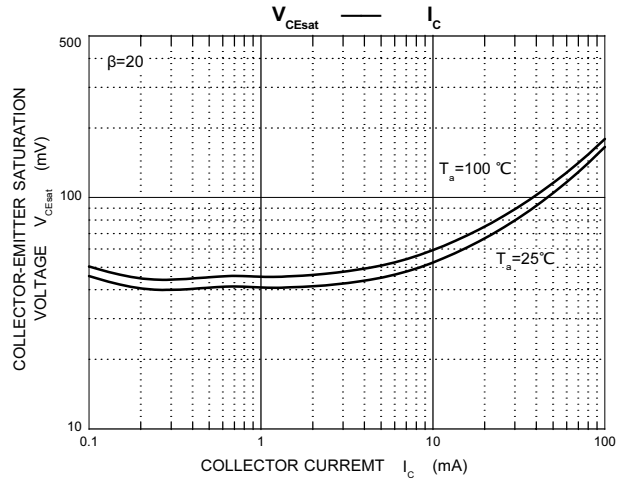
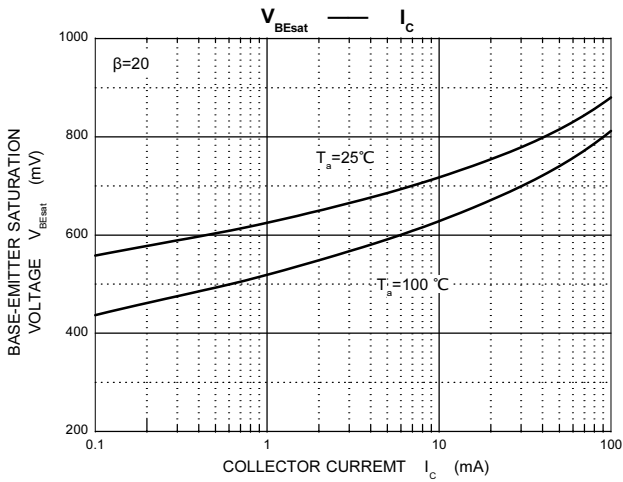
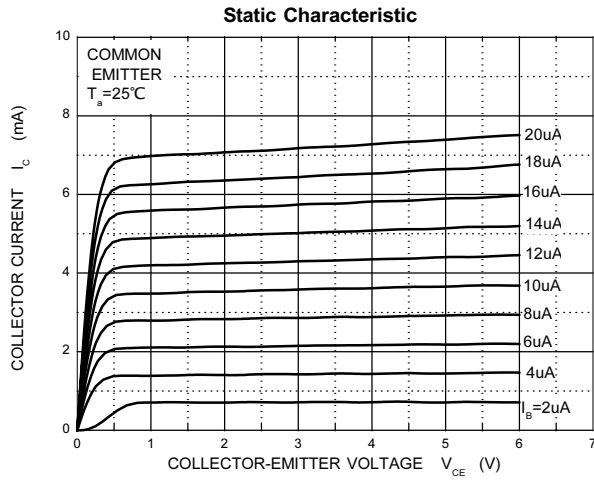

# BC846A thru BC849C

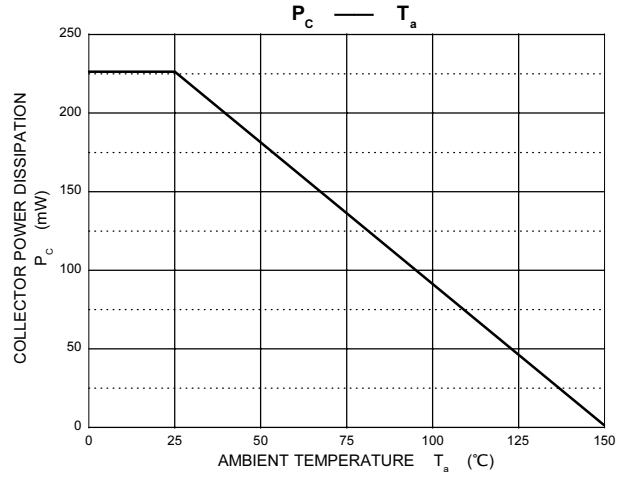
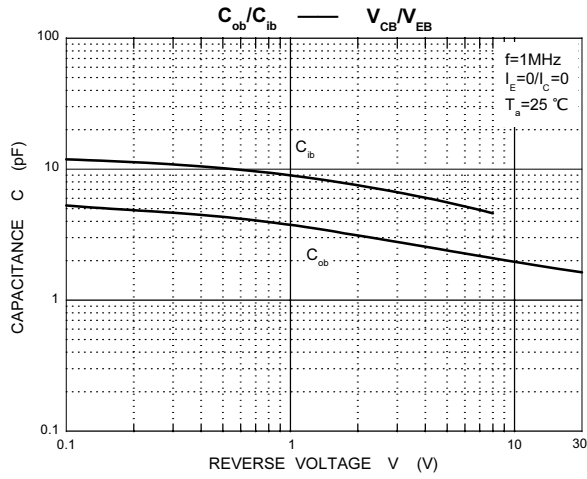



Micro Commercial Components

### Ordering Information :

Device	Packing
Part Number-TP	Tape&Reel; 3Kpcs/Reel

Note : Adding "-HF" suffix for halogen free, eg. Part Number-TP-HF

#### \*\*\*IMPORTANT NOTICE\*\*\*

**Micro Commercial Components Corp.** reserves the right to make changes without further notice to any product herein to make corrections, modifications, enhancements, improvements, or other changes. **Micro Commercial Components Corp.** does not assume any liability arising out of the application or use of any product described herein; neither does it convey any license under its patent rights, nor the rights of others. The user of products in such applications shall assume all risks of such use and will agree to hold **Micro Commercial Components Corp.** and all the companies whose products are represented on our website, harmless against all damages.

#### \*\*\*LIFE SUPPORT\*\*\*

MCC's products are not authorized for use as critical components in life support devices or systems without the express written approval of Micro Commercial Components Corporation.

#### \*\*\*CUSTOMER AWARENESS\*\*\*

Counterfeiting of semiconductor parts is a growing problem in the industry. Micro Commercial Components (MCC) is taking strong measures to protect ourselves and our customers from the proliferation of counterfeit parts. MCC strongly encourages customers to purchase MCC parts either directly from MCC or from Authorized MCC Distributors who are listed by country on our web page cited below. Products customers buy either from MCC directly or from Authorized MCC Distributors are genuine parts, have full traceability, meet MCC's quality standards for handling and storage. **MCC will not provide any warranty coverage or other assistance for parts bought from Unauthorized Sources.** MCC is committed to combat this global problem and encourage our customers to do their part in stopping this practice by buying direct or from authorized distributors.

[www.mccsemi.com](http://www.mccsemi.com)

# Mouser Electronics

Authorized Distributor

Click to View Pricing, Inventory, Delivery & Lifecycle Information:

## [Micro Commercial Components \(MCC\):](#)

[BC846A-TP](#) [BC846B-TP](#) [BC848A-TP](#) [BC848B-TP](#) [BC848C-TP](#) [BC849B-TP](#) [BC849C-TP](#) [BC847B-TP](#) [BC847A-TP](#) [BC847C-TP](#)