

T-1³/₄ (5 mm) Diffused LED Lamps

Technical Data

HLMP-3301
HLMP-3401
HLMP-3507
HLMP-3762
HLMP-3862
HLMP-3962
HLMP-D401

Features

- **High Intensity**
- **Choice of 4 Bright Colors**
 - High Efficiency Red
 - Orange
 - Yellow
 - High Performance Green
- **Popular T-1³/₄ Diameter Package**
- **Selected Minimum Intensities**
- **Wide Viewing Angle**
- **General Purpose Leads**

- **Reliable and Rugged**
- **Available on Tape and Reel**

Description

This family of T-1³/₄ tinted, diffused LED lamps is widely used in general purpose indicator applications. Diffusants, tints, and optical design are balanced to yield superior light output and wide viewing angles. Several intensity choices are available in each color for increased design flexibility.

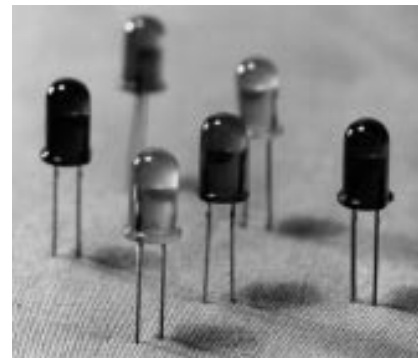

Selection Guide

Material/Color	Part Number	Luminous Intensity I _v (mcd) at 10 mA	
		Min.	Max.
GaP HER	HLMP-3301	5.4	—
	HLMP-3301-D00xx	2.1	—
	HLMP-3301-F00xx	5.4	—
	HLMP-3301-FG0xx	5.4	17.2
	HLMP-3762	8.6	—
	HLMP-3762-G00xx	8.6	—
GaP Yellow	HLMP-3401	5.7	—
	HLMP-3401-E00xx	5.7	—
	HLMP-3401-EF0xx	5.7	18.4
	HLMP-3401-EFBxx	5.7	18.4
	HLMP-3862	9.2	—
	HLMP-3862-F00xx	9.2	—
GaP Orange	HLMP-3862-FGBxx	9.2	29.4
	HLMP-D401	5.4	—
	HLMP-D401-D00xx	2.1	—
	HLMP-D401-EF0xx	3.4	10.8
GaP Green	HLMP-D401-F00xx	5.4	—
	HLMP-3507	4.2	—
	HLMP-3507-D00xx	4.2	—
	HLMP-3507-EF0xx	6.7	21.2
	HLMP-3962	10.6	—
	HLMP-3962-F00xx	10.6	—

Part Numbering System

HLMP - x x xx - x x x xx

Mechanical Option

00: Bulk
 01: Tape & Reel, Crimped Leads
 02: Tape & Reel, Straight Leads
 B1: Right Angle Housing, Uneven Leads
 B2: Right Angle Housing, Even Leads
 DD: Ammo Pack
 R4: Tape & Reel, Counter Clockwise

Color Bin Options

0: Full Color Bin Distribution
 B: Color Bins 2 & 3 only

Maximum Iv Bin Options

0: Open (no max. limit)
 Others: Please refer to the Iv Bin Table

Minimum Iv Bin Options

Please refer to the Iv Bin Table

Brightness Level

0x: Less Brightness
 62: Higher Brightness

Color Options

3,7: GaP HER
 4,8: GaP Yellow (except D4xx)
 5,9: GaP Green

Package Options

3: T-1 3/4 (5 mm)
 D: T-1 3/4 (5 mm) GaP Orange

Package Dimensions

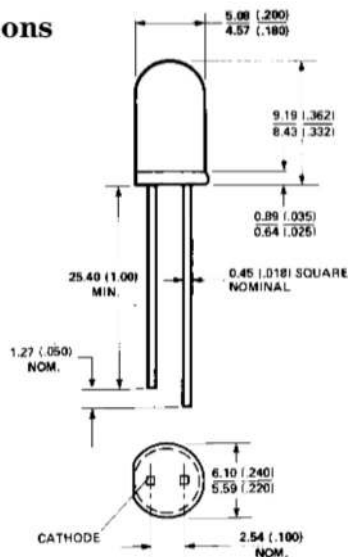

NOTES:
 1. ALL DIMENSIONS ARE IN MILLIMETRES (INCHES).
 2. AN EPOXY MENISCUS MAY EXTEND ABOUT 1mm (.040") DOWN THE LEADS.

Optical/Electrical Characteristics at $T_A = 25^\circ\text{C}$

Symbol	Parameter	Color	Min.	Typ.	Max.	Units	Test Condition
$2\theta^{1/2}$	Included Angle Between Half Luminous Intensity Points	High Efficiency Red Orange Yellow Green		60 60 60 60		Deg.	$I_F = 10\text{ mA}$ See Note 1
λ_{PEAK}	Peak Wavelength	High Efficiency Red Orange Yellow Green		635 600 583 565		nm	Measurement at Peak
$\Delta\lambda_{1/2}$	Spectral Line Halfwidth	HER/Orange Yellow Green		40 36 28		nm	
λ_d	Dominant Wavelength	High Efficiency Red Orange Yellow Green		626 602 585 569		nm	See Note 2
τ_s	Speed of Response	High Efficiency Red Orange Yellow Green		90 280 90 500		ns	
C	Capacitance	High Efficiency Red Orange Yellow Green		11 4 15 18		pF	$V_F = 0;$ $f = 1\text{ MHz}$
$R\theta_{\text{J-PIN}}$	Thermal Resistance	All		260		$^\circ\text{C/W}$	Junction to Cathode Lead
V_F	Forward Voltage	HER/Orange Yellow Green		1.9 2.0 2.1	2.4 2.4 2.7	V	$I_F = 10\text{ mA}$
V_R	Reverse Breakdown Voltage	All	5.0			V	$I_R = 100\ \mu\text{A}$
η_V	Luminous Efficacy	High Efficiency Red Orange Yellow Green	– –	145 380 500 595		$\frac{\text{lumens}}{\text{Watt}}$	See Note 3

Notes:

- $\theta^{1/2}$ is the off-axis angle at which the luminous intensity is half the axial luminous intensity.
- The dominant wavelength, λ_d , is derived from the CIE chromaticity diagram and represents the single wavelength which defines the color of the device.
- Radiant intensity, I_e , in Watts/steradian, may be found from the equation $I_e = I_v/\eta_v$, where I_v is the luminous intensity in candelas and η_v is the luminous efficacy in lumens/Watt.

Absolute Maximum Ratings at $T_A = 25^\circ\text{C}$

Parameter	HER/Orange	Yellow	Green/ Emerald Green	Units
Peak Forward Current	90	60	90	mA
Average Forward Current ^[1]	25	20	25	mA
DC Current ^[2]	30	20	30	mA
Power Dissipation ^[3]	135	85	135	mW
Reverse Voltage ($I_R = 100 \mu\text{A}$)	5	5	5	V
Transient Forward Current ^[4] (10 μsec Pulse)	500	500	500	mA
LED Junction Temperature	110	110	110	$^\circ\text{C}$
Operating Temperature Range	-55 to +100	-55 to +100	-20 to +100	$^\circ\text{C}$
Storage Temperature Range			-55 to +100	
Lead Soldering Temperature [1.6 mm (0.063 in.) from body]	260 $^\circ\text{C}$ for 5 seconds			

Notes:

1. See Figure 5 (Red/Orange), 10 (Yellow), or 15 (Green) to establish pulsed operating conditions.
2. For Red, Orange and Green series derate linearly from 50 $^\circ\text{C}$ at 0.5 mA/ $^\circ\text{C}$. For Yellow series derate linearly from 50 $^\circ\text{C}$ at 0.2 mA/ $^\circ\text{C}$.
3. 1.8 mW/ $^\circ\text{C}$. For Yellow series derate power linearly from 50 $^\circ\text{C}$ at 1.6 mW/ $^\circ\text{C}$.
4. The transient peak current is the maximum non-recurring peak current that can be applied to the device without damaging the LED die and wirebond. It is not recommended that the device be operated at peak currents beyond the peak forward current listed in the Absolute Maximum Ratings.

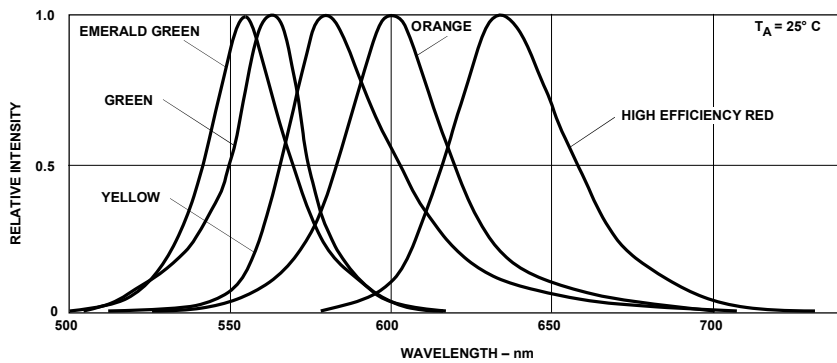

Figure 1. Relative Intensity vs. Wavelength.

T-1³/₄ High Efficiency Red, Orange Diffused Lamps

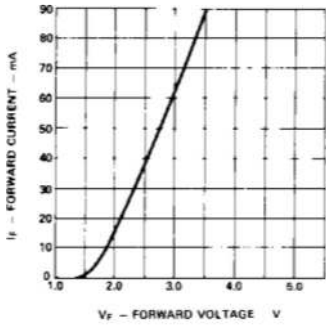

Figure 2. Forward Current vs. Forward Voltage Characteristics.

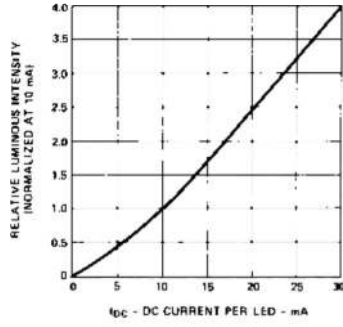

Figure 3. Relative Luminous Intensity vs. DC Forward Current.

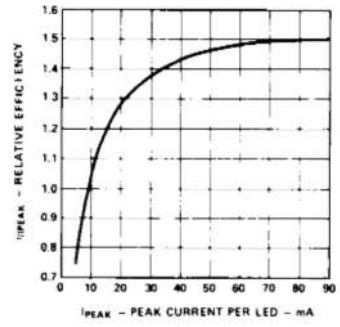

Figure 4. Relative Efficiency (Luminous Intensity per Unit Current) vs. Peak LED Current.

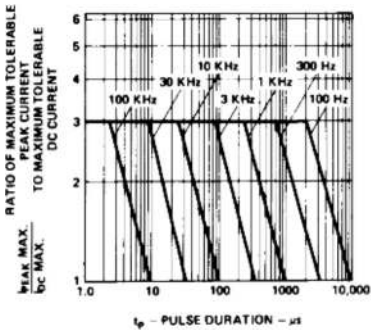

Figure 5. Maximum Tolerable Peak Current vs. Pulse Duration. (I_{DC} MAX as per MAX Ratings).

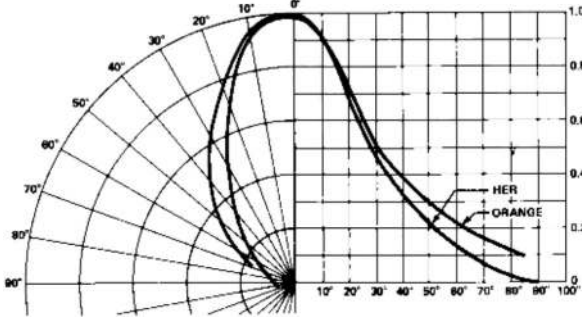

Figure 6. Relative Luminous Intensity vs. Angular Displacement.

T-1³/₄ Yellow Diffused Lamps

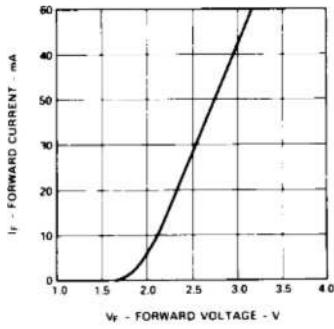

Figure 7. Forward Current vs. Forward Voltage Characteristics.

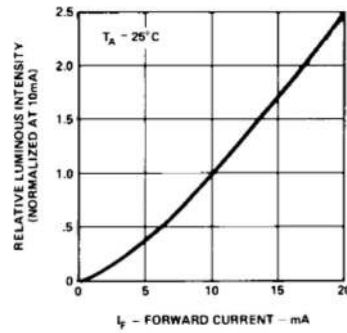

Figure 8. Relative Luminous Intensity vs. Forward Current.

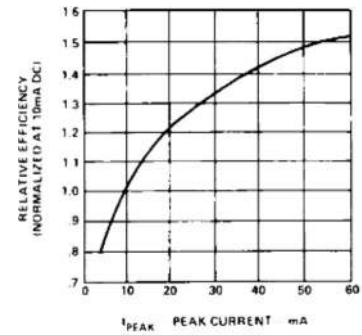

Figure 9. Relative Efficiency (Luminous Intensity per Unit Current) vs. Peak Current.

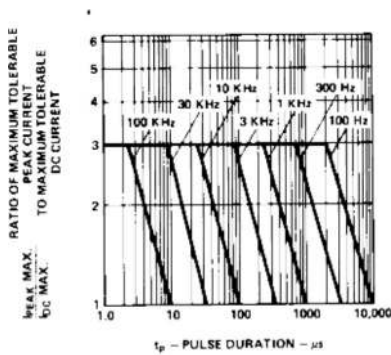

Figure 10. Maximum Tolerable Peak Current vs. Pulse Duration. (I_{DC} MAX as per MAX Ratings).

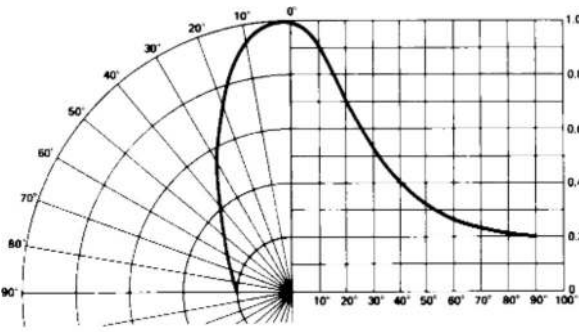

Figure 11. Relative Luminous Intensity vs. Angular Displacement.

T-1^{3/4} Green/Emerald Green Diffused Lamps

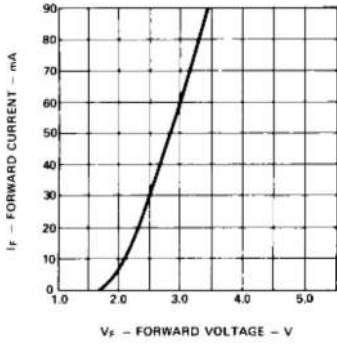

Figure 12. Forward Current vs. Forward Voltage Characteristics.

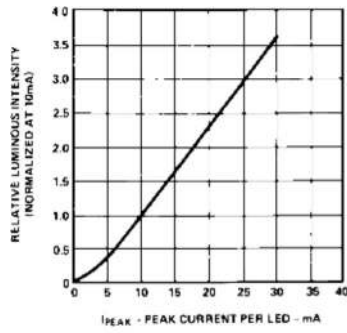

Figure 13. Relative Luminous Intensity vs. DC Forward Current.

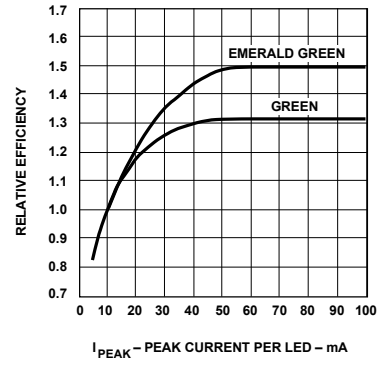

Figure 14. Relative Efficiency (Luminous Intensity per Unit Current) vs. Peak LED Current.

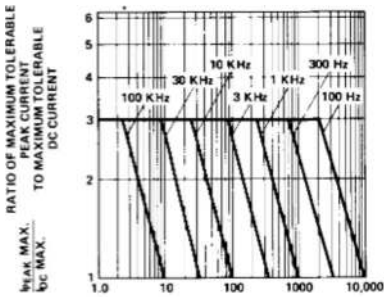

Figure 15. Maximum Tolerable Peak Current vs. Pulse Duration. (I_{DC} MAX as per MAX Ratings).

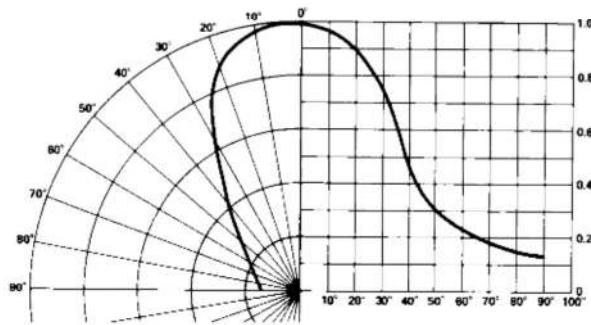

Figure 16. Relative Luminous Intensity vs. Angular Displacement.

Intensity Bin Limits

Color	Bin	Intensity Range (mcd)	
		Min.	Max.
Red/Orange	D	2.4	3.8
	E	3.8	6.1
	F	6.1	9.7
	G	9.7	15.5
	H	15.5	24.8
	I	24.8	39.6
	J	39.6	63.4
	K	63.4	101.5
	L	101.5	162.4
	M	162.4	234.6
	N	234.6	340.0
	O	340.0	540.0
	P	540.0	850.0
	Q	850.0	1200.0
	R	1200.0	1700.0
	S	1700.0	2400.0
	T	2400.0	3400.0
	U	3400.0	4900.0
	V	4900.0	7100.0
	W	7100.0	10200.0
X	10200.0	14800.0	
Y	14800.0	21400.0	
Z	21400.0	30900.0	
Yellow	E	6.5	10.3
	F	10.3	16.6
	G	16.6	26.5
	H	26.5	42.3
	I	42.3	67.7
	J	67.7	108.2
	K	108.2	173.2
	L	173.2	250.0
	M	250.0	360.0
	N	360.0	510.0
	O	510.0	800.0
	P	800.0	1250.0
	Q	1250.0	1800.0
	R	1800.0	2900.0
	S	2900.0	4700.0
T	4700.0	7200.0	
U	7200.0	11700.0	
V	11700.0	18000.0	
W	18000.0	27000.0	

Intensity Bin Limits, continued

Color	Bin	Intensity Range (mcd)	
		Min.	Max.
Green	D	4.7	7.6
	E	7.6	12.0
	F	12.0	19.1
	G	19.1	30.7
	H	30.7	49.1
	I	49.1	78.5
	J	78.5	125.7
	K	125.7	201.1
	L	201.1	289.0
	M	289.0	417.0
	N	417.0	680.0
	O	680.0	1100.0
	P	1100.0	1800.0
	Q	1800.0	2700.0
	R	2700.0	4300.0
	S	4300.0	6800.0
	T	6800.0	10800.0
U	10800.0	16000.0	
V	16000.0	25000.0	
W	25000.0	40000.0	

Maximum tolerance for each bin limit is $\pm 18\%$.

Color Categories

Color	Category #	Lambda (nm)	
		Min.	Max.
Green	6	561.5	564.5
	5	564.5	567.5
	4	567.5	570.5
	3	570.5	573.5
	2	573.5	576.5
Yellow	1	582.0	584.5
	3	584.5	587.0
	2	587.0	589.5
	4	589.5	592.0
	5	592.0	593.0
Orange	1	597.0	599.5
	2	599.5	602.0
	3	602.0	604.5
	4	604.5	607.5
	5	607.5	610.5
	6	610.5	613.5
	7	613.5	616.5
	8	616.5	619.5

Tolerance for each bin limit is ± 0.5 nm.

Mechanical Option Matrix

Mechanical Option Code	Definition
00	Bulk Packaging, minimum increment 500 pcs/bag
01	Tape & Reel, crimped leads, minimum increment 1300 pcs/bag
02	Tape & Reel, straight leads, minimum increment 1300 pcs/bag
B1	Right Angle Housing, uneven leads, minimum increment 500 pcs/bag
B2	Right Angle Housing, even leads, minimum increment 500 pcs/bag
DD	Ammo Pack, straight leads with minimum increment 2K/pack
R4	Tape & Reel, straight leads, counter clockwise, anode lead leaving the reel first

Note:

All categories are established for classification of products. Products may not be available in all categories. Please contact your local Agilent representative for further clarification/information.

www.semiconductor.agilent.com

Data subject to change.
Copyright © 2001 Agilent Technologies, Inc.
March 21, 2001
Obsoletes 5968-4161E (2/99)
5988-1857EN