

2 x Dualband WiFi External MIMO Antenna



AEACBK050048-MW2



Ø50.0 x 48.0 mm
RoHS/RoHS II Compliant
MSL = 1

Features

- 2 x Dualband 2.4/5GHz WiFi MIMO antenna
- IP67 Rated
- Linear polarization
- VSWR < 2.0
- Gain of 2.0 dBi
- Screw mounting

Applications

- WiFi/ISM applications
- IoT
- M2M
- Remote monitoring
- Smart meters
- Gateways and routers
- Public safety

Electrical Specifications

Parameters	Min.	Typ.	Max.	Units	Note
Frequency Range		2400 ~ 2483.5		MHz	
		4900 ~ 5825			
VSWR			2.5		
Polarization	Linear				
Impedance		50		Ω	
Gain		2		dBi	

Mechanical Characteristics

Parameters	Description
Connector	2 x SMA Male
Cable Type	2 x LMR100/3M
Mounting	Screw
Radom Material	ABS

Environmental Characteristics

Parameters	Description
Operating temperature	-40°C to +85°C
Relative Humidity	Up to 95 %
Vibration	10 to 55 Hz with 1.5 mm amplitude 2 hours
Ingress Protection	IP67 (excluding cable outlet)

2 x Dualband WiFi External MIMO Antenna



AEACBK050048-MW2



Ø50.0 x 48.0 mm
RoHS/RoHS II Compliant
MSL = 1

Dimensions

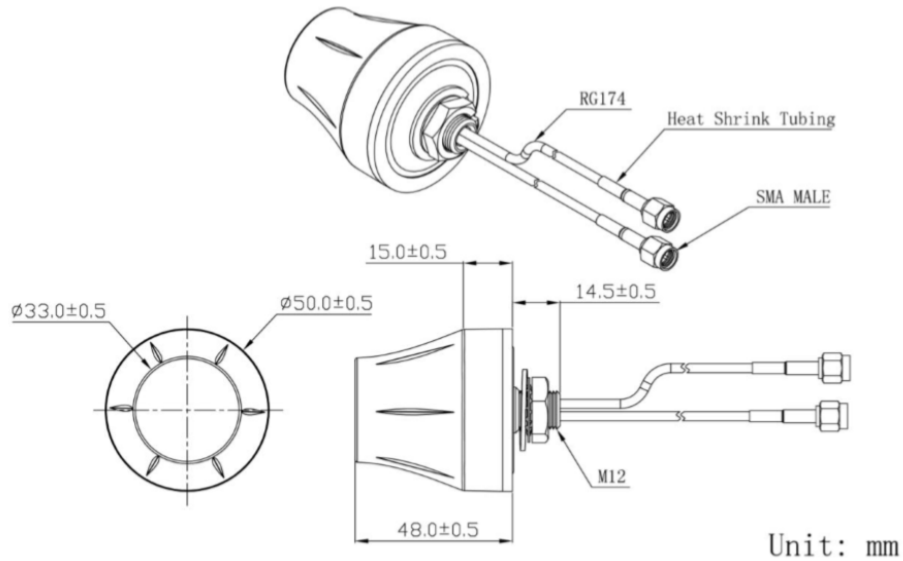

Product Image



2 x Dualband WiFi External MIMO Antenna



AEACBK050048-MW2



Ø50.0 x 48.0 mm
RoHS/RoHS II Compliant
MSL = 1

VSWR

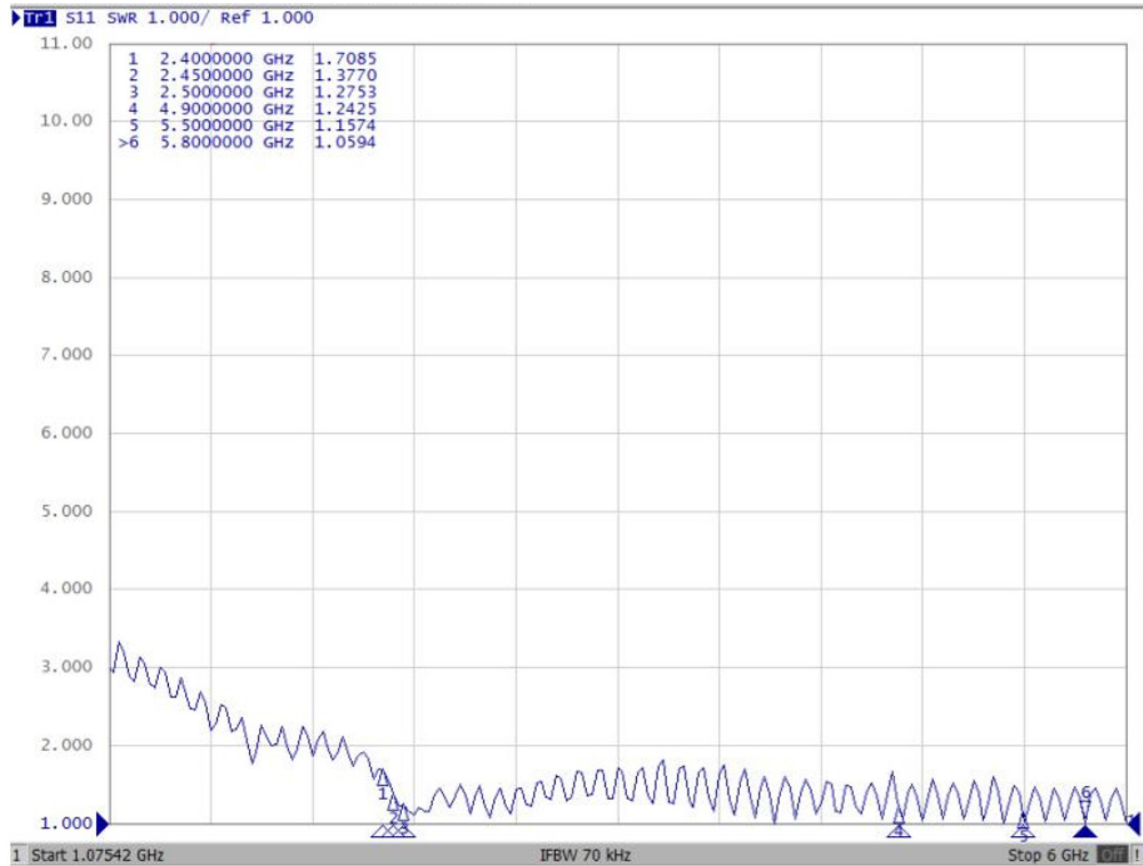

2 x Dualband WiFi External MIMO Antenna



AEACBK050048-MW2



Ø50.0 x 48.0 mm
RoHS/RoHS II Compliant
MSL = 1

Radiation Pattern:

2D - Pattern

XY - Plane

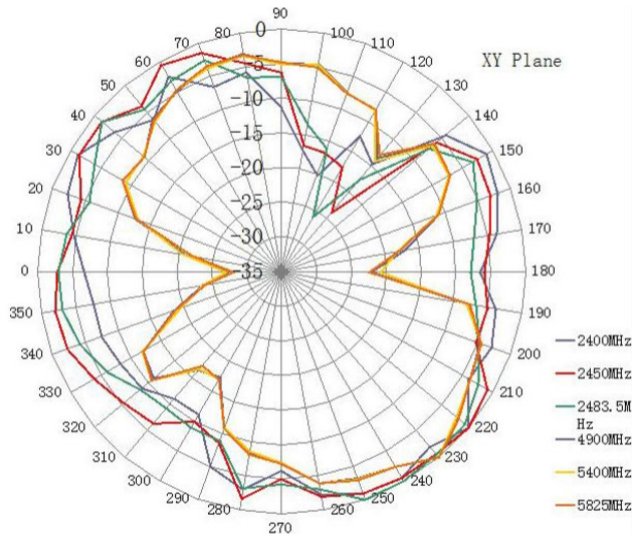

XZ - Plane

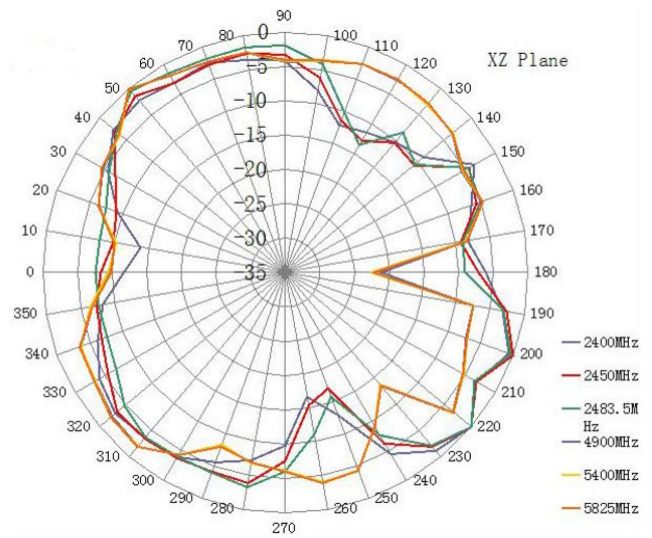

YZ - Plane

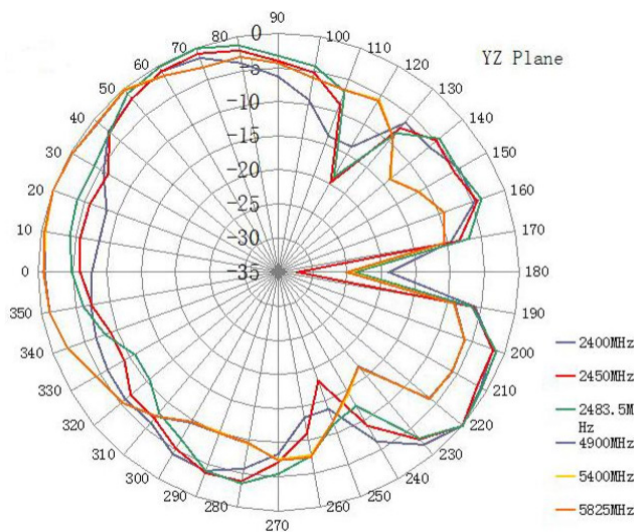

ATTENTION: Abracon LLC's products are COTS – Commercial-Off-The-Shelf products; suitable for Commercial, Industrial and, where designated, Automotive Applications. Abracon's products are not specifically designed for Military, Aviation, Aerospace, Life-dependent Medical applications or any application requiring high reliability where component failure could result in loss of life and/or property. For applications requiring high reliability and/or presenting an extreme operating environment, written consent and authorization from Abracon LLC is required. Please contact Abracon LLC for more information.



5101 Hidden Creek Ln Spicewood TX 78669
Phone: 512-371-6159 | Fax: 512-351-8858
For terms and conditions of sales, please visit:
www.abracon.com

REVISED: 07.31.2020

ABRACON IS
ISO9001-2015
CERTIFIED

2 x Dualband WiFi External MIMO Antenna



AEACBK050048-MW2



Ø50.0 x 48.0 mm
RoHS/RoHS II Compliant
MSL = 1

3D – Pattern

Frequency: 2400 MHz

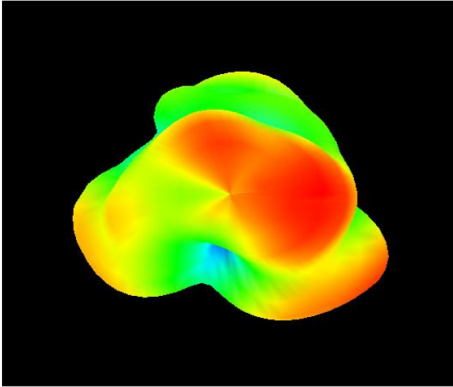

Frequency: 2450 MHz

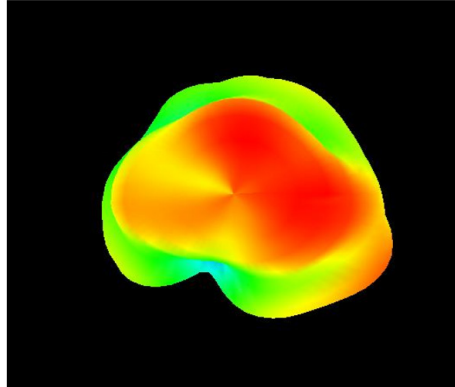

Frequency: 2500 MHz

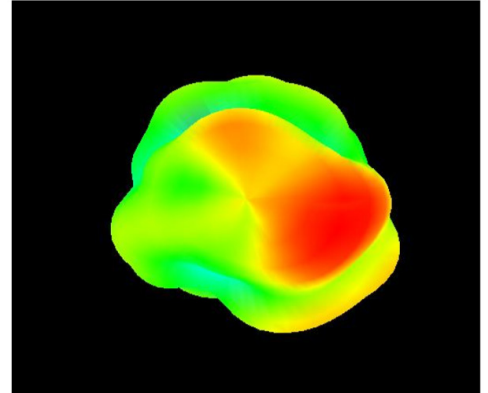

Frequency: 4900 MHz

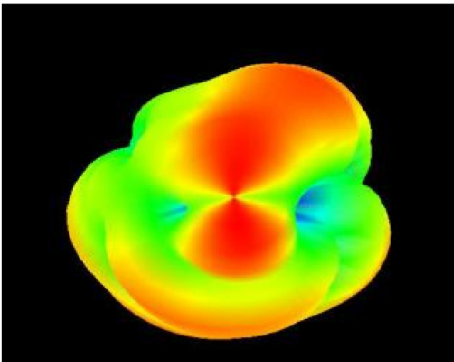

Frequency: 5500 MHz

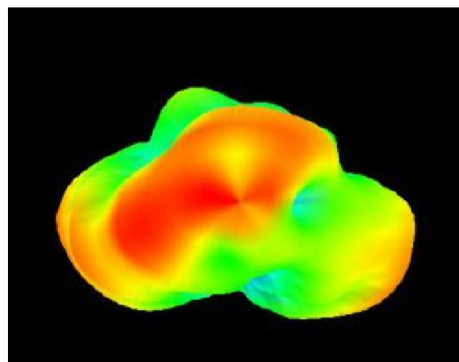

Frequency: 5800 MHz

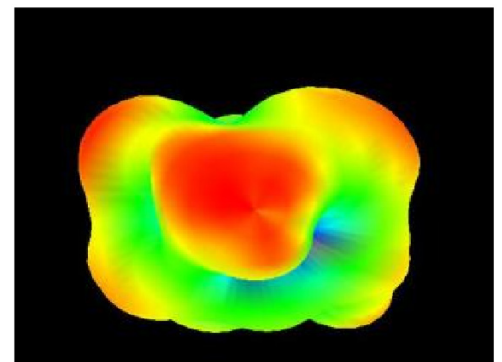

Frequency (MHz)	Efficiency	Gain (dBi)
2400	0.58	2.15
2450	0.56	1.95
2500	0.55	1.03
4900	0.51	0.56
5500	0.53	0.58
5800	0.52	0.67

Packaging

The package consists of 100 pcs of antennas and is of dimension 70.0 x 32.0 x 15.0 cm.



5101 Hidden Creek Ln Spicewood TX 78669
Phone: 512-371-6159 | Fax: 512-351-8858
For terms and conditions of sales, please visit:
www.abracon.com

REVISED: 07.31.2020

ABRACON IS
ISO9001-2015
CERTIFIED

Mouser Electronics

Authorized Distributor

Click to View Pricing, Inventory, Delivery & Lifecycle Information:

[ABRACON:](#)

[AEACBK050048-MW2](#)