

TOSHIBA CMOS Linear Integrated Circuit Silicon Monolithic

# TCR2EF series

# TCR2EE series

## 200 mA CMOS Low Drop-Out Regulator with Fast Load Transient Response

The TCR2EF and TCR2EE series are CMOS single-output voltage regulators with an on/off control input, featuring low dropout voltage, low output noise voltage and fast load transient response.

These voltage regulators are available in fixed output voltages between 1.0 V and 5.0 V and capable of driving up to 200 mA. They feature overcurrent protection, an Auto-discharge function.

The TCR2EF and TCR2EE series has a low dropout voltage of 180 mV ( 2.5 V output,  $I_{OUT} = 150$  mA) with low output noise voltage of  $35 \mu V_{rms}$  (2.5 V output) and a load transient response of only  $\Delta V_{OUT} = \pm 60$  mV (  $I_{OUT} = 1$  mA  $\leftrightarrow$  150 mA,  $C_{OUT} = 1.0 \mu F$  ).

Thus, the TCR2EF and TCR2EE series are suitable for sensitive power supply such as Analog and RF applications.

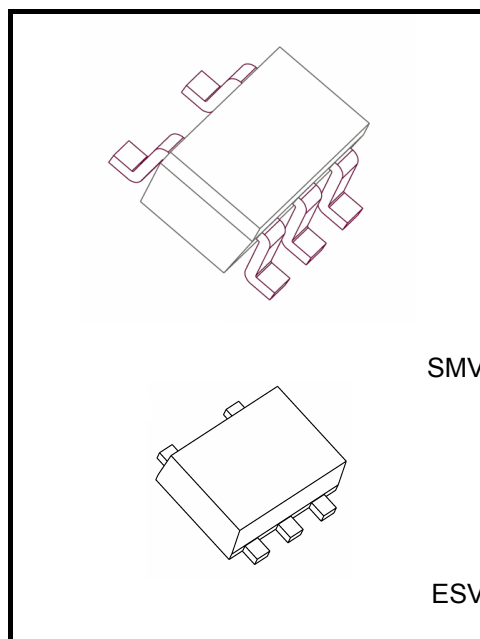

### Features

- Low Drop-Out voltage
  - $V_{IN} - V_{OUT} = 150$  mV (typ.) at 3.0 V-output,  $I_{OUT} = 150$  mA
  - $V_{IN} - V_{OUT} = 180$  mV (typ.) at 2.5 V-output,  $I_{OUT} = 150$  mA
  - $V_{IN} - V_{OUT} = 230$  mV (typ.) at 1.8 V-output,  $I_{OUT} = 150$  mA
  - $V_{IN} - V_{OUT} = 380$  mV (typ.) at 1.2 V-output,  $I_{OUT} = 150$  mA
  - $V_{IN} - V_{OUT} = 510$  mV (typ.) at 1.0 V-output,  $I_{OUT} = 150$  mA
- Low output noise voltage (  $V_{NO} = 35 \mu V_{rms}$  (typ.) at 2.5 V-output,  $I_{OUT} = 10$  mA,  $10$  Hz  $< f < 100$  kHz )
- Fast load transient response (  $\Delta V_{OUT} = \pm 60$  mV (typ.) at  $I_{OUT} = 1$  mA  $\leftrightarrow$  150 mA,  $C_{OUT} = 1.0 \mu F$  )
- Low quiescent bias current (  $I_B = 35 \mu A$  (typ.) at  $I_{OUT} = 0$  mA )
- High ripple rejection ( R.R = 73 dB (typ.) at 2.5V-output,  $I_{OUT} = 10$  mA,  $f = 1$  kHz )
- Wide range Output Voltage line up (  $V_{OUT} = 1.0$  to 5.0 V )
- High  $V_{OUT}$  accuracy  $\pm 1.0\%$  (  $1.8V \leq V_{OUT}$  )
- Overcurrent protection
- Auto-discharge
- Pull down connection between CONTROL and GND
- Ceramic capacitors can be used (  $C_{IN} = 0.1 \mu F$ ,  $C_{OUT} = 1.0 \mu F$  )
- Small package ESV (SOT-553) (1.6 mm x 1.6 mm x 0.55 mm)
- General package SMV (SOT-25) (2.8 mm x 2.9 mm x 1.1 mm)

Weight :  
 SMV (SOT-25)(SC-74A) : 16 mg ( typ.)  
 ESV (SOT-553) : 3.0 mg ( typ.)

Start of commercial production  
 2012-10

## Absolute Maximum Ratings (Ta = 25°C)

Characteristics	Symbol	Rating	Unit	
Input voltage	$V_{IN}$	6.0	V	
Control voltage	$V_{CT}$	-0.3 to 6.0	V	
Output voltage	$V_{OUT}$	-0.3 to $V_{IN} + 0.3$	V	
Output current	$I_{OUT}$	200	mA	
Power dissipation	$P_D$	SMV	200 (Note 1)	mW
			580 (Note 2)	
		ESV	150 (Note 1)	
			320 (Note 3)	
Operation temperature range	$T_{opr}$	-40 to 85	°C	
Junction temperature	$T_j$	150	°C	
Storage temperature range	$T_{stg}$	-55 to 150	°C	

Note: Using continuously under heavy loads (e.g. the application of high temperature/current/voltage and the significant change in temperature, etc.) may cause this product to decrease in the reliability significantly even if the operating conditions (i.e. operating temperature/current/voltage, etc.) are within the absolute maximum ratings and the operating ranges.

Please design the appropriate reliability upon reviewing the Toshiba Semiconductor Reliability Handbook ("Handling Precautions"/"Derating Concept and Methods") and individual reliability data (i.e. reliability test report and estimated failure rate, etc).

Note 1: Unit Rating

Note 2: Rating at mounting on a board  
(FR4 board: 25.4 mm × 25.4 mm × 1.6 mm)

Note 3: Rating at mounting on a board  
(FR4 board dimension: 30 mm × 30 mm × 0.8 mm)

## Pin Assignment (top view)

**SMV(SOT-25)(SC-74A)**

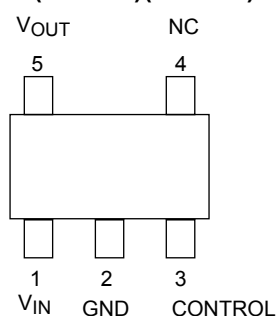

**ESV(SOT-553)**

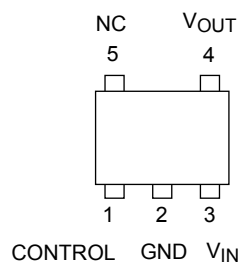

## List of Products Number, Output voltage and Marking

Product No.		V <sub>OUT</sub> (V) (typ.)	Marking	Product No.		V <sub>OUT</sub> (V) (typ.)	Marking
SMV(SOT-25)	ESV(SOT-553)			SMV(SOT-25)	ESV(SOT-553)		
TCR2EF10	TCR2EE10	1.0	1N0	TCR2EF28	TCR2EE28	2.8	2N8
TCR2EF105	TCR2EE105	1.05	1NA	TCR2EF285	TCR2EE285	2.85	2ND
TCR2EF11	TCR2EE11	1.1	1N1	TCR2EF29	TCR2EE29	2.9	2N9
TCR2EF115	TCR2EE115	1.15	1NB	-	TCR2EE295	2.95	2NE
TCR2EF12	TCR2EE12	1.2	1N2	TCR2EF30	TCR2EE30	3.0	3N0
TCR2EF125	TCR2EE125	1.25	1NC	-	TCR2EE305	3.05	3NA
TCR2EF13	TCR2EE13	1.3	1N3	TCR2EF31	TCR2EE31	3.1	3N1
TCR2EF135	TCR2EE135	1.35	1ND	TCR2EF32	TCR2EE32	3.2	3N2
TCR2EF14	TCR2EE14	1.4	1N4	TCR2EF33	TCR2EE33	3.3	3N3
-	TCR2EE145	1.45	1NE	-	TCR2EE335	3.35	3ND
TCR2EF15	TCR2EE15	1.5	1N5	-	TCR2EE34	3.4	3N4
-	TCR2EE17	1.7	1N7	TCR2EF36	TCR2EE36	3.6	3N6
TCR2EF18	TCR2EE18	1.8	1N8	-	TCR2EE39	3.9	3N9
-	TCR2EE185	1.85	1NF	TCR2EF40	TCR2EE40	4.0	4N0
TCR2EF19	TCR2EE19	1.9	1N9	TCR2EF41	TCR2EE41	4.1	4N1
TCR2EF20	TCR2EE20	2.0	2N0	-	TCR2EE42	4.2	4N2
-	TCR2EE24	2.4	2N4	TCR2EF45	TCR2EE45	4.5	4N5
TCR2EF25	TCR2EE25	2.5	2N5	-	TCR2EE48	4.8	4N8
TCR2EF27	TCR2EE27	2.7	2N7	TCR2EF50	TCR2EE50	5.0	5N0
-	TCR2EE275	2.75	2NF				

Please ask your local retailer about the devices with other output voltages.

### Marking (top view)

Example: TCR2EF33 (3.3 V output)

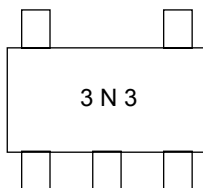

Example: TCR2EE33 (3.3 V output)

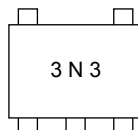

## Electrical Characteristics

(Unless otherwise specified,

$V_{IN} = V_{OUT} + 1\text{ V}$ ,  $I_{OUT} = 50\text{ mA}$ ,  $C_{IN} = 0.1\text{ }\mu\text{F}$ ,  $C_{OUT} = 1.0\text{ }\mu\text{F}$ ,  $T_j = 25^\circ\text{C}$ )

Characteristics	Symbol	Test Condition	Min	Typ.	Max	Unit	
Output voltage accuracy	$V_{OUT}$	$I_{OUT} = 50\text{ mA}$ (Note 4)	$V_{OUT} < 1.8\text{ V}$	-18	—	+18	mV
			$1.8\text{ V} \leq V_{OUT}$	-1.0	—	+1.0	%
Input voltage	$V_{IN}$	$I_{OUT} = 1\text{ mA}$	1.5	—	5.5	V	
Line regulation	Reg·line	$V_{OUT} + 0.5\text{ V} \leq V_{IN} \leq 5.5\text{ V}$ , $I_{OUT} = 1\text{ mA}$	—	1	15	mV	
Load regulation	Reg·load	$1\text{ mA} \leq I_{OUT} \leq 150\text{ mA}$	—	15	30	mV	
Quiescent current	$I_B$	$I_{OUT} = 0\text{ mA}$	—	35	60	$\mu\text{A}$	
Stand-by current	$I_B$ (OFF)	$V_{CT} = 0\text{ V}$	—	0.1	1.0	$\mu\text{A}$	
Drop-out voltage	$V_{IN}-V_{OUT}$	$I_{OUT} = 150\text{ mA}$ (Note 5)	—	180	230	mV	
Temperature coefficient	$T_{CVO}$	$-40^\circ\text{C} \leq T_{opr} \leq 85^\circ\text{C}$	—	100	—	ppm/ $^\circ\text{C}$	
Output noise voltage	$V_{NO}$	$V_{IN} = V_{OUT} + 1\text{ V}$ , $I_{OUT} = 10\text{ mA}$ , $10\text{ Hz} \leq f \leq 100\text{ kHz}$ , $T_a = 25^\circ\text{C}$ (Note 5)	—	35	—	$\mu\text{V}_{rms}$	
Ripple rejection ratio	R.R.	$V_{IN} = V_{OUT} + 1\text{ V}$ , $I_{OUT} = 10\text{ mA}$ , $f = 1\text{ kHz}$ , $V_{Ripple} = 500\text{ mV}_{p-p}$ , $T_a = 25^\circ\text{C}$ (Note 5)	—	73	—	dB	
Load transient response	$\Delta V_{OUT}$	$I_{OUT} = 1\text{ mA} \Leftrightarrow 150\text{ mA}$ , $C_{OUT} = 1.0\text{ }\mu\text{F}$	—	$\pm 60$	—	mV	
Control voltage (ON)	$V_{CT}$ (ON)	—	1.0	—	5.5	V	
Control voltage (OFF)	$V_{CT}$ (OFF)	—	0	—	0.4	V	

Note 4: Stable state with fixed  $I_{OUT}$  condition

Note 5: The 2.5 V output product

Note 6: All characteristics of over 4.5V output products are measured at  $V_{IN} = V_{OUT} + 0.5\text{ V}$  conditions.

## Drop-out voltage ( $I_{OUT} = 150\text{ mA}$ , $C_{IN} = 0.1\text{ }\mu\text{F}$ , $C_{OUT} = 1.0\text{ }\mu\text{F}$ , $T_j = 25^\circ\text{C}$ )

Output voltages	Symbol	Min	Typ.	Max	Unit
1.0 V, 1.05 V	$V_{IN} - V_{OUT}$	—	510	770	mV
1.1 V, 1.15 V		—	440	670	
1.2 V, 1.25 V		—	380	570	
1.3 V		—	350	470	
1.4 V		—	310	420	
$1.5\text{ V} \leq V_{OUT} < 1.8\text{ V}$		—	290	390	
$1.8\text{ V} \leq V_{OUT} < 2.5\text{ V}$		—	230	310	
$2.5\text{ V} \leq V_{OUT} < 3.0\text{ V}$		—	180	230	
$3.0\text{ V} \leq V_{OUT} \leq 5.0\text{ V}$		—	150	200	

## Application Note

### 1. Recommended Application Circuit

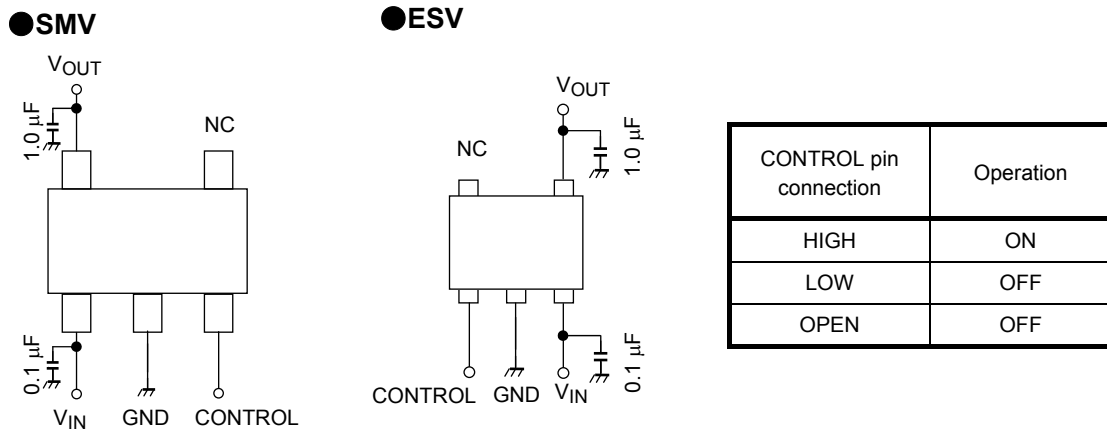

The figure above shows the recommended configuration for using a Low-Dropout regulator. Insert a capacitor at  $V_{OUT}$  and  $V_{IN}$  pins for stable input/output operation. (Ceramic capacitors can be used).

### 2. Power Dissipation

Both unit and board-mounted power dissipation ratings for TCR2EF series and TCR2EE series are available in the Absolute Maximum Ratings table.

Power dissipation is measured on the board shown below.

### Testing Board of Thermal Resistance

#### SMV

\*Board material: FR4 board  
 Board dimension: 25.4 mm × 25.4 mm × 1.6 mm  
 Copper area: 645 mm<sup>2</sup>

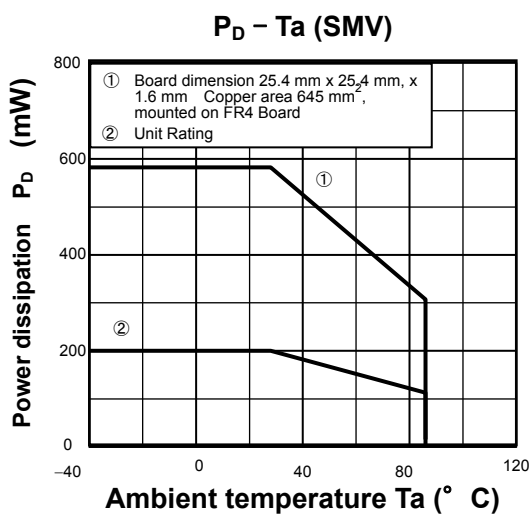

#### ESV

\*Board material: FR4 board  
 Board dimension: 30 mm × 30 mm × 0.8 mm  
 Copper area: 20 mm<sup>2</sup>

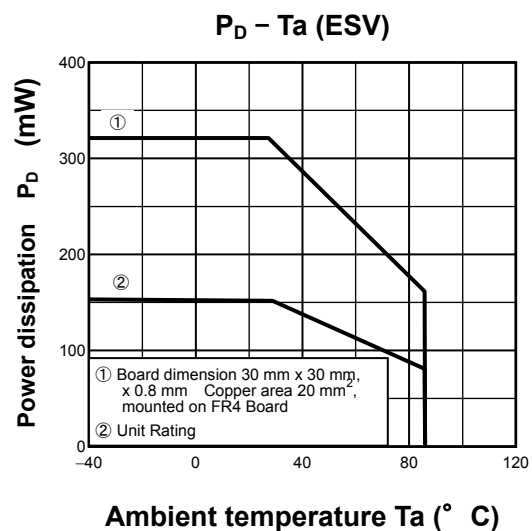

**Attention in Use**

- **Output Capacitors**  
Ceramic capacitors can be used for these devices. However, because of the type of the capacitors, there might be unexpected thermal features. Please consider application condition for selecting capacitors. And Toshiba recommend the ESR of ceramic capacitor is under 10  $\Omega$ .
  
- **Mounting**  
The long distance between IC and output capacitor might affect phase assurance by impedance in wire and inductor. For stable power supply, output capacitor need to mount near IC as much as possible. Also VIN and GND pattern need to be large and make the wire impedance small as possible.
  
- **Permissible Loss**  
Please have enough design patterns for expected maximum permissible loss. And under consideration of surrounding temperature, input voltage, and output current etc, we recommend proper dissipation ratings for maximum permissible loss; in general maximum dissipation rating is 70 to 80 percent.
  
- **Overcurrent Protection Circuit**  
Overcurrent protection circuit is designed in these products, but this does not assure for the suppression of uprising device operation. If output pins and GND pins are shorted out, these products might be break down.  
In use of these products, please read through and understand dissipation idea for absolute maximum ratings from the above mention or our 'Semiconductor Reliability Handbook'. Then use these products under absolute maximum ratings in any condition. Furthermore, Toshiba recommend inserting failsafe system into the design.

## Representative Typical Characteristics

### 1) Output Voltage vs. Input Voltage

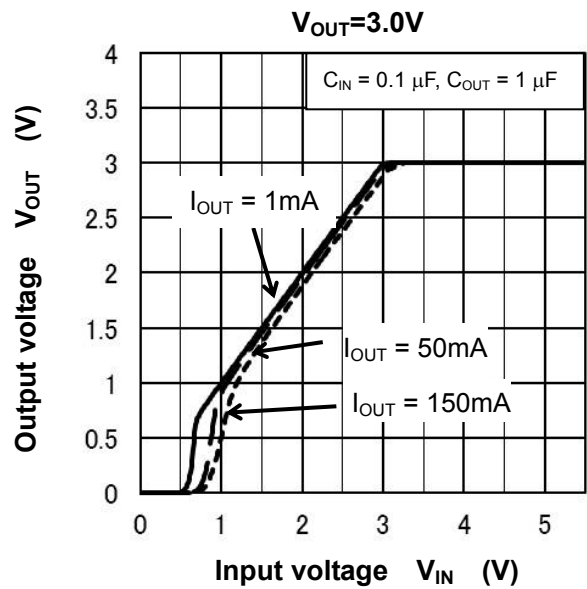
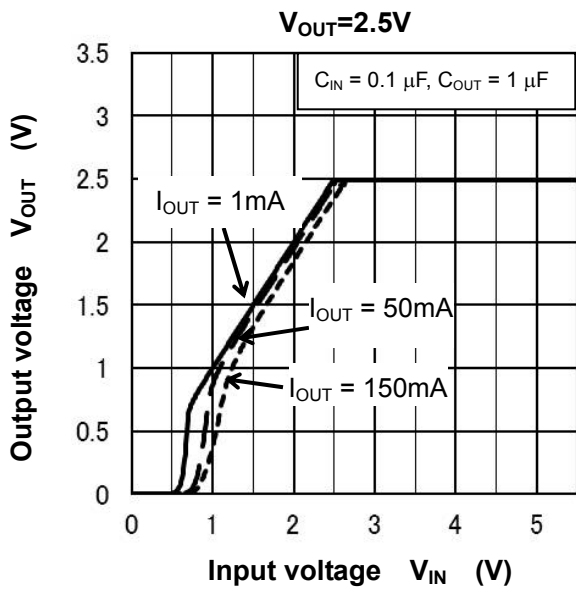
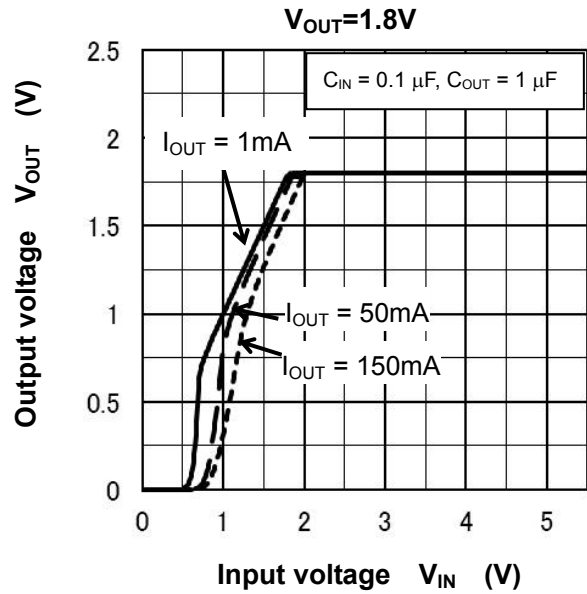
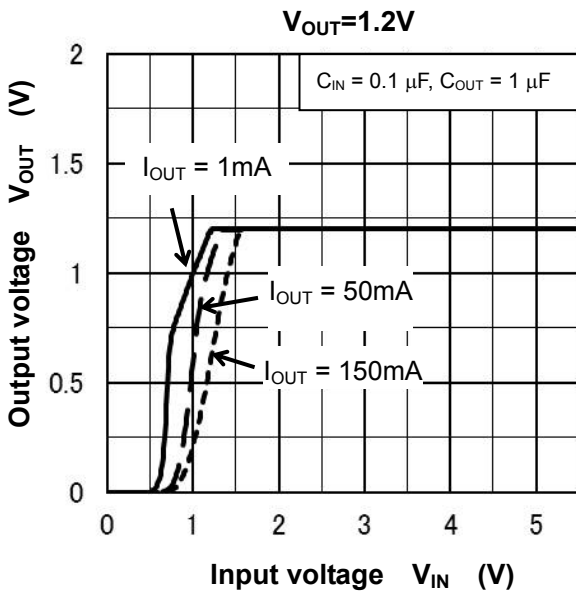

### 2) Output Voltage vs. Output Current

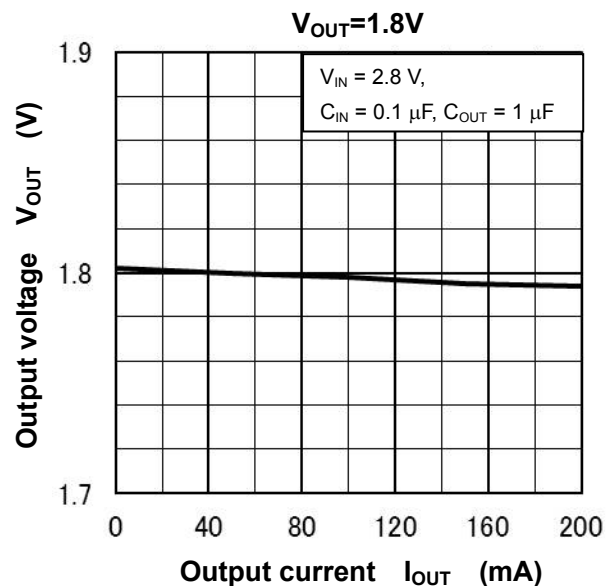
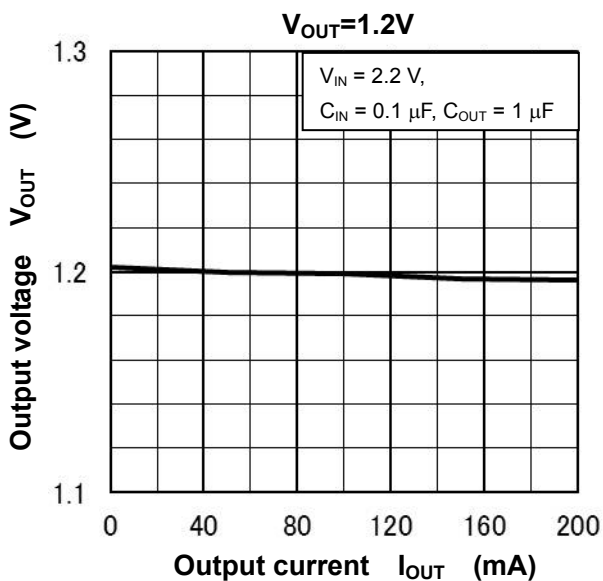

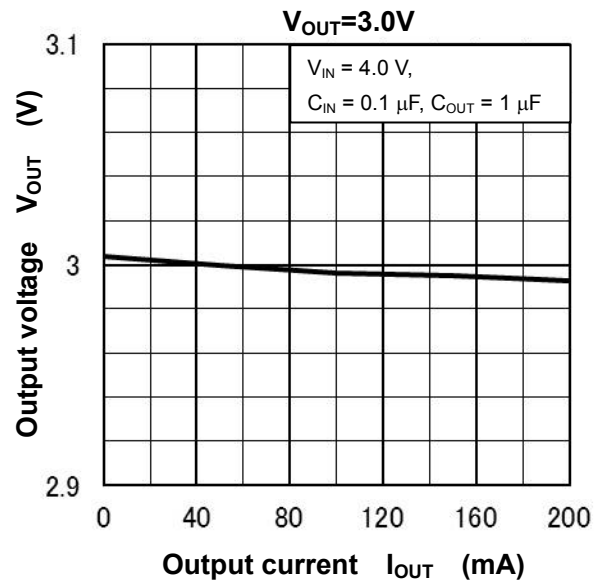
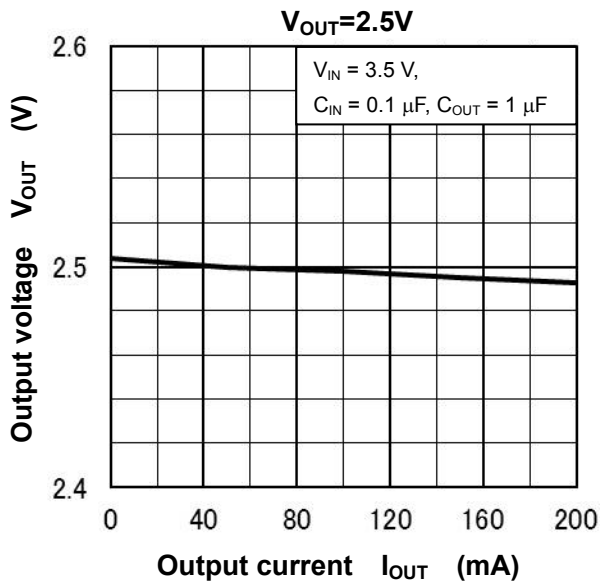

3) Output Voltage vs. Ambient Temperature

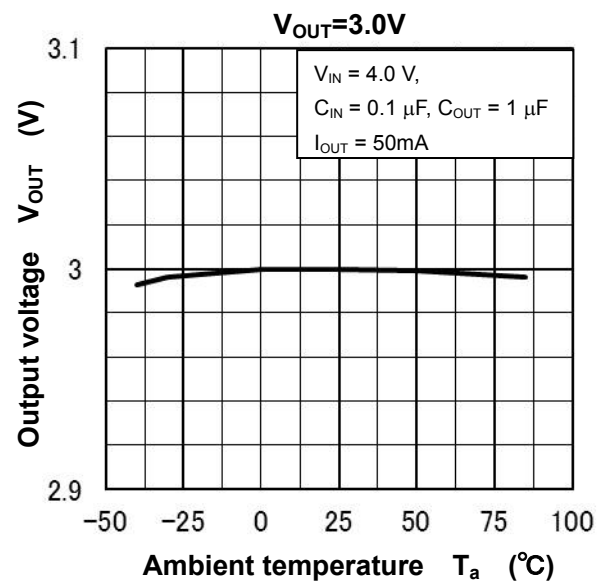
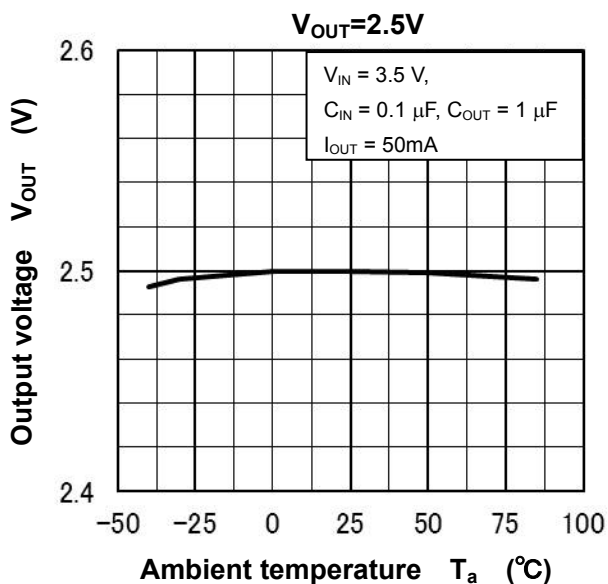
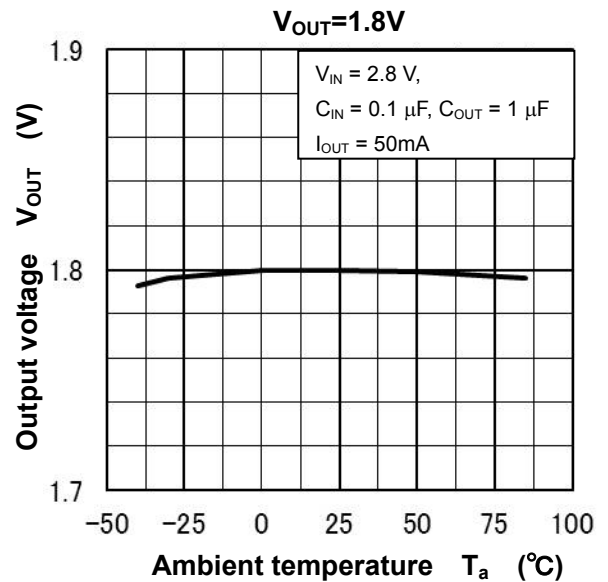
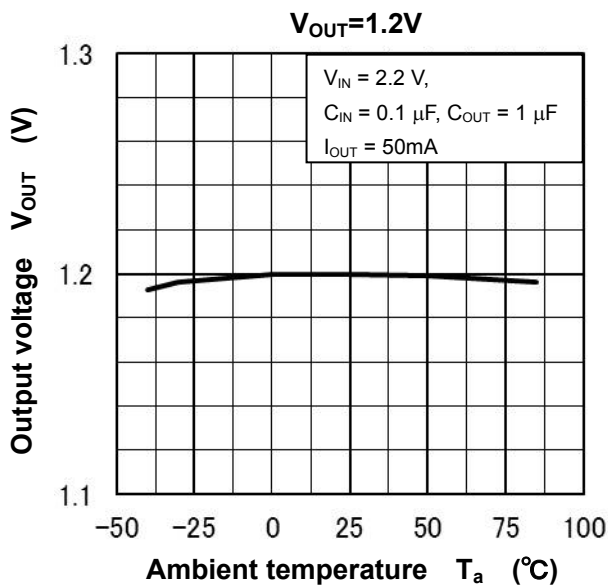



## 4) Dropout Voltage vs. Output Current

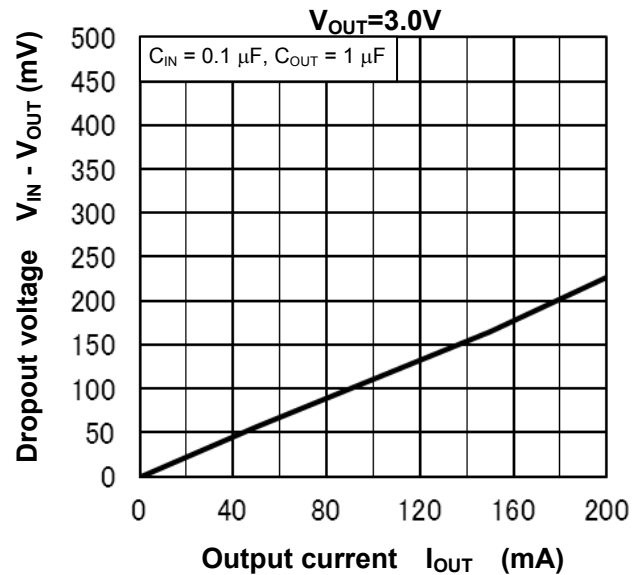
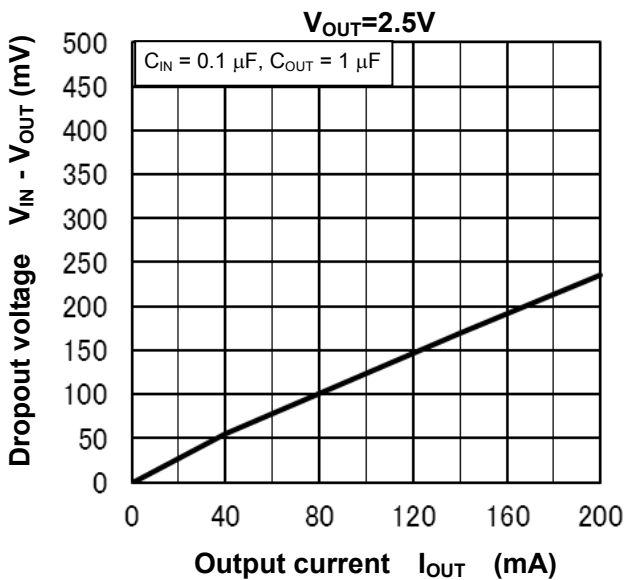
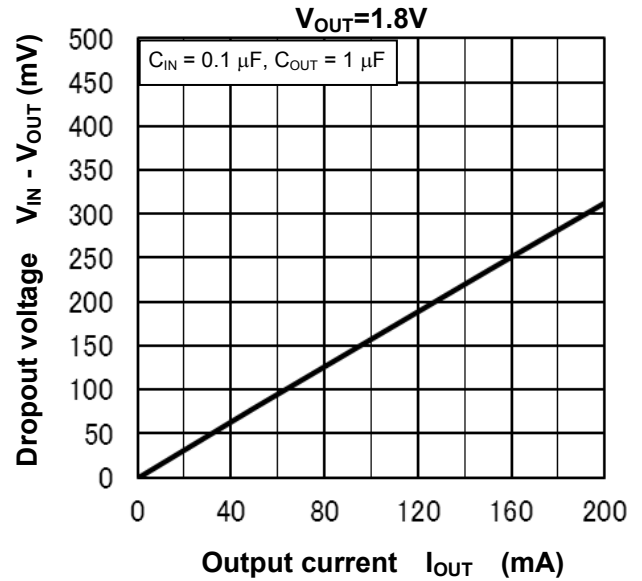
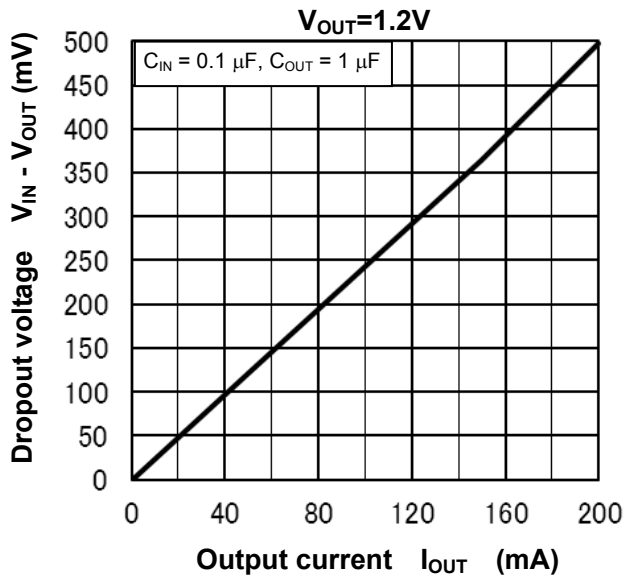

## 5) Quiescent Current vs. Input Voltage

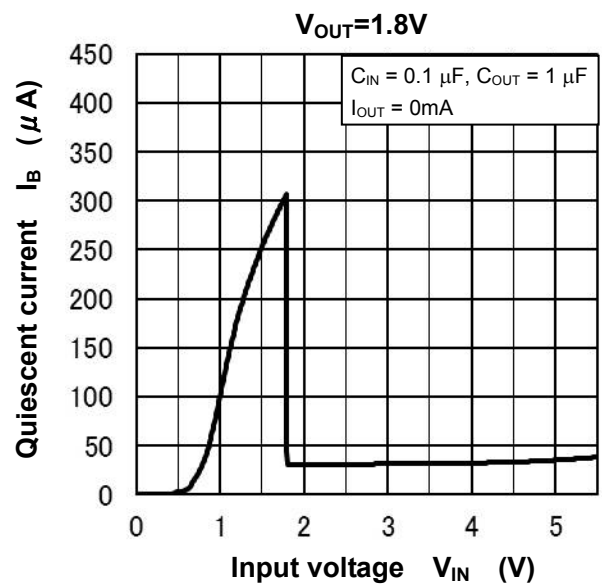
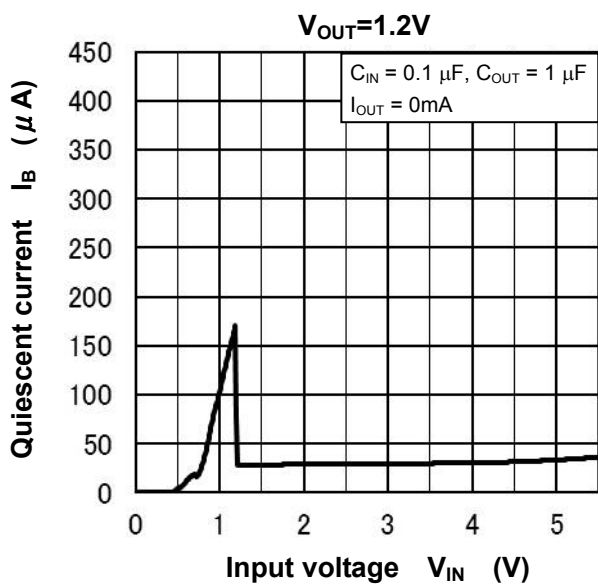

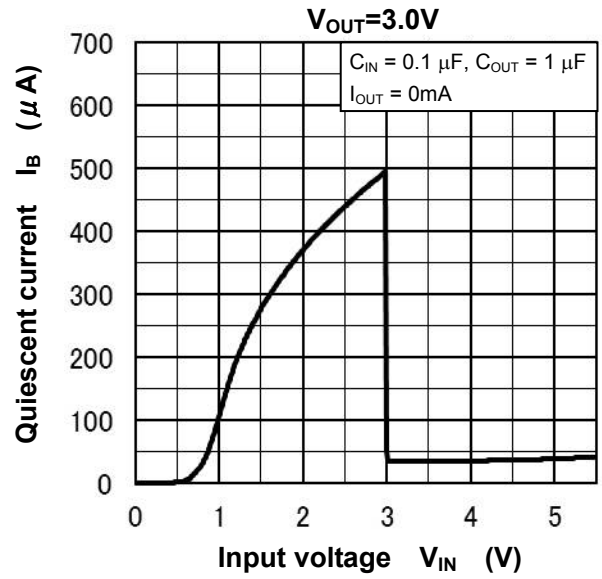
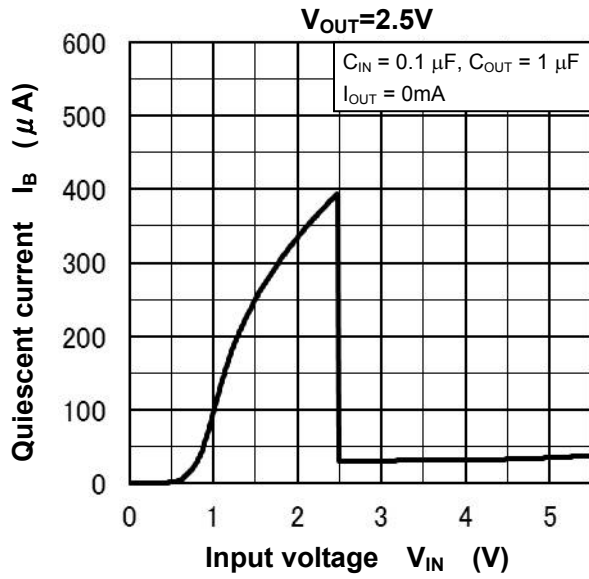

## 6) Quiescent Current vs. Ambient Temperature

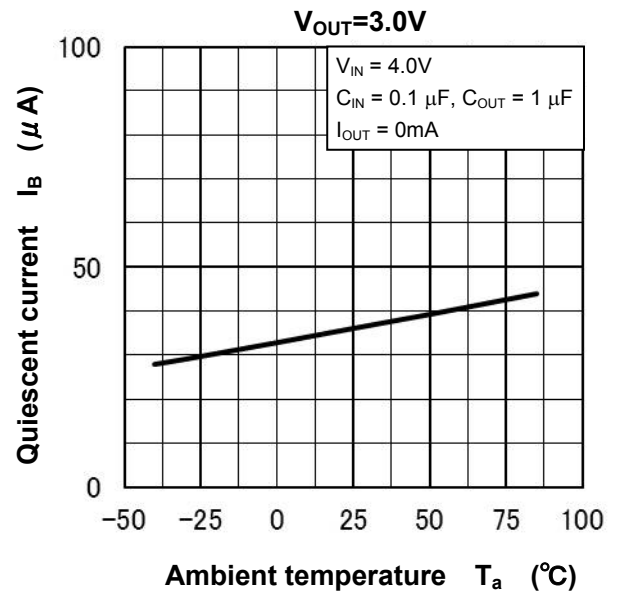
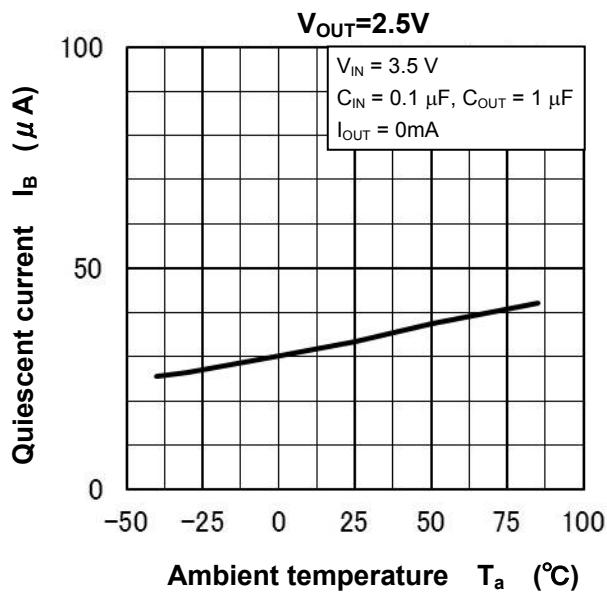
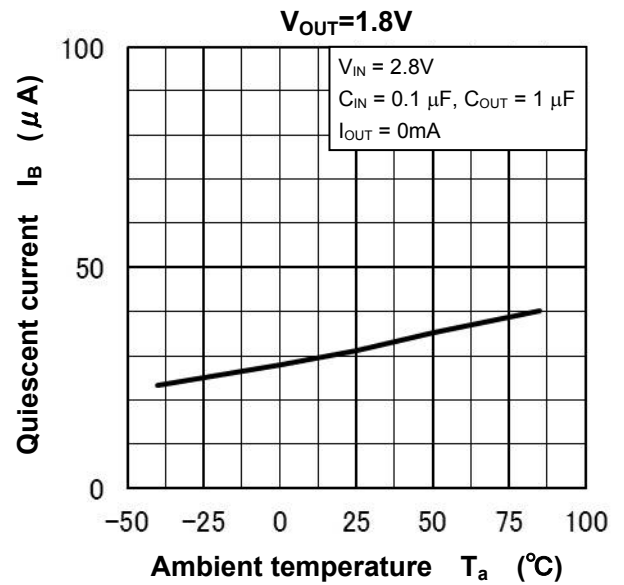
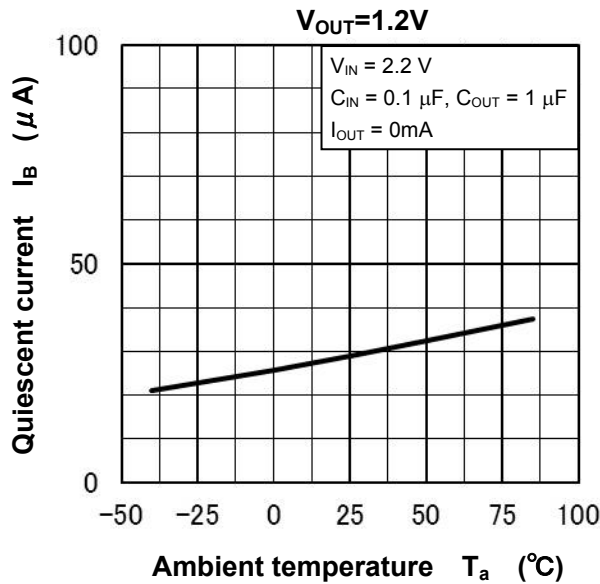

7) Output Voltage vs. Output Current

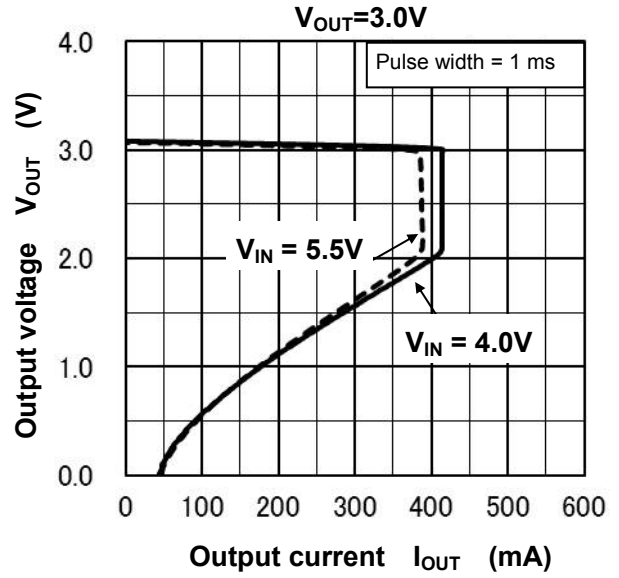
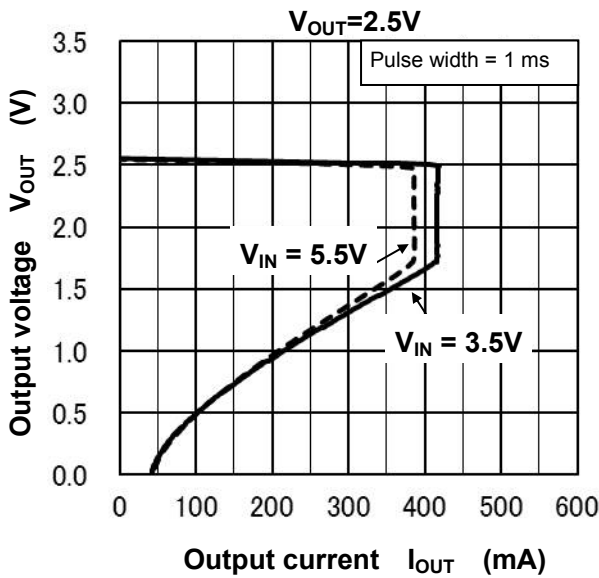
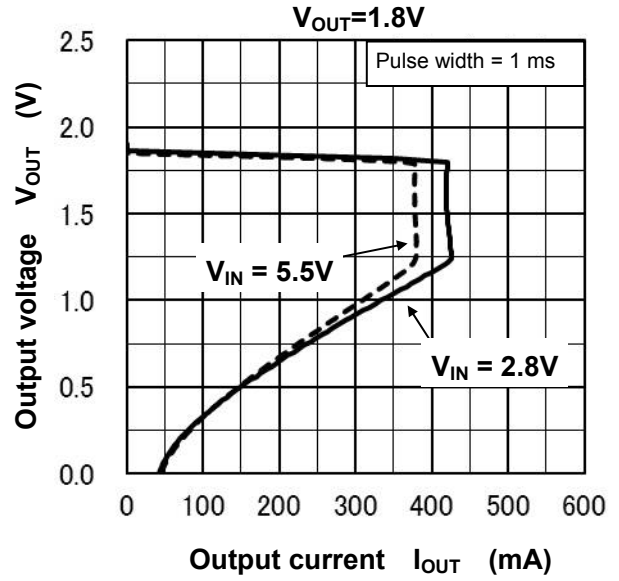
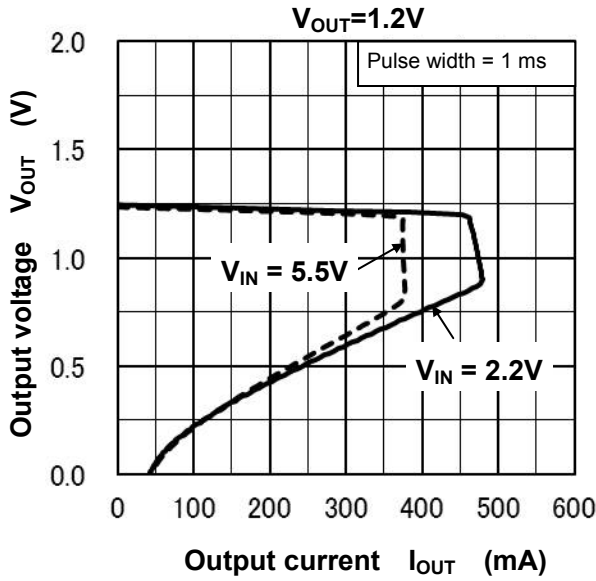

8) Ripple Rejection Ratio vs. Frequency

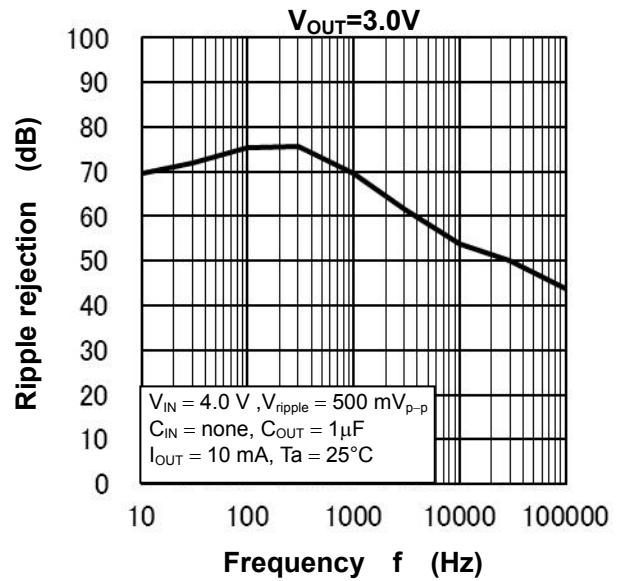
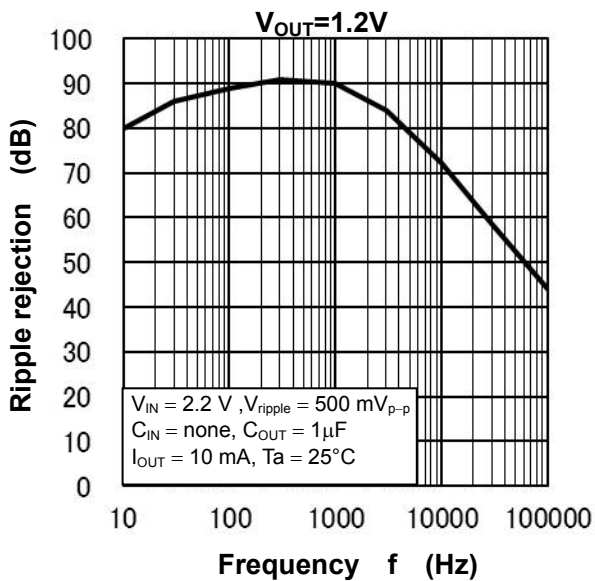

## 9) Control Transient Response

$V_{OUT}=1.2V$

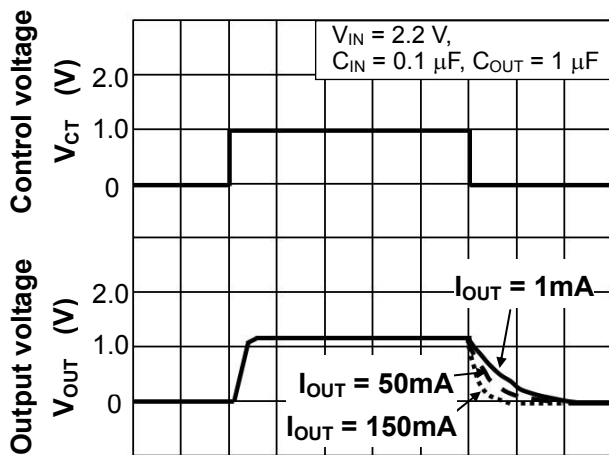

Time t (25  $\mu s$ /div)

$V_{OUT}=1.8V$

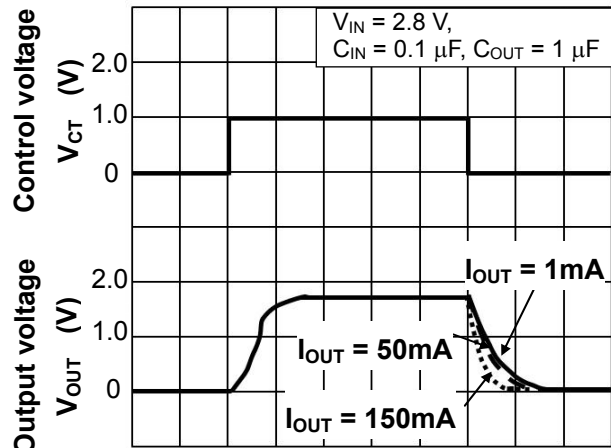

Time t (25  $\mu s$ /div)

$V_{OUT}=2.5V$

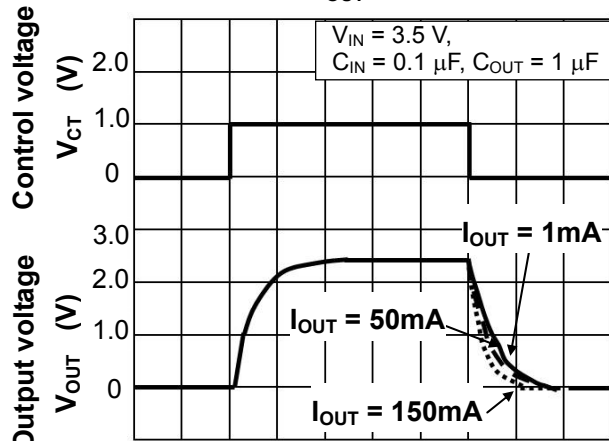

Time t (25  $\mu s$ /div)

$V_{OUT}=3.0V$

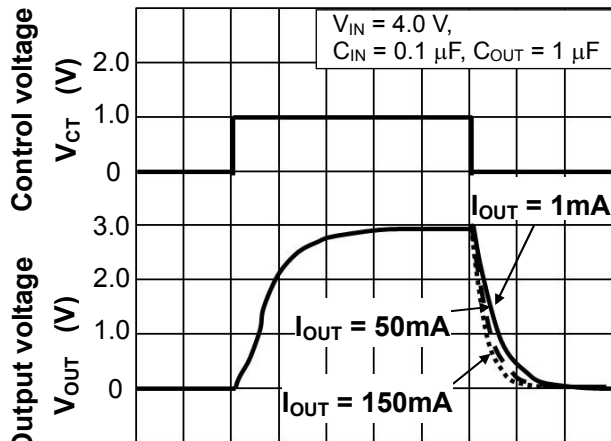

Time t (25  $\mu s$ /div)

## 10) Control Transient Response

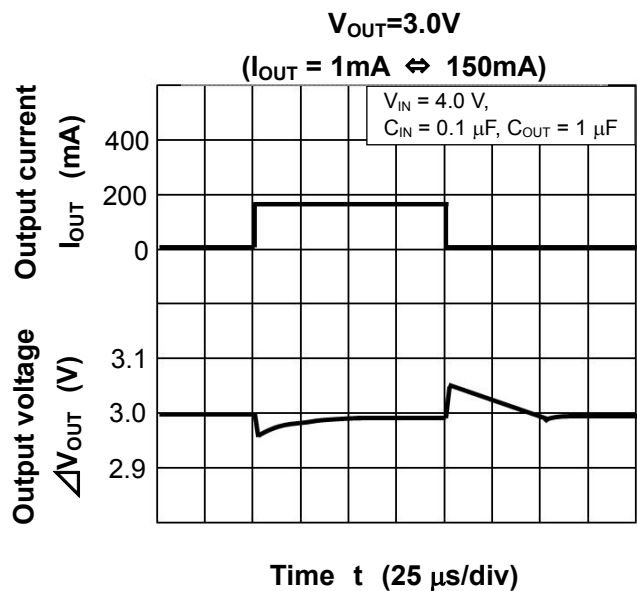
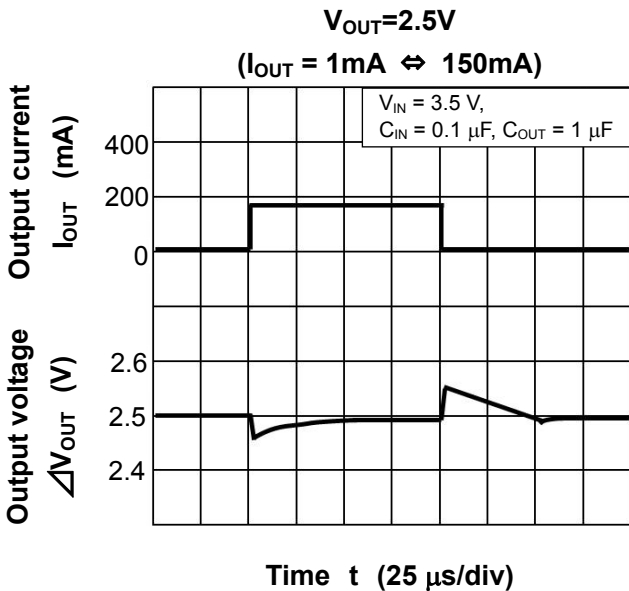
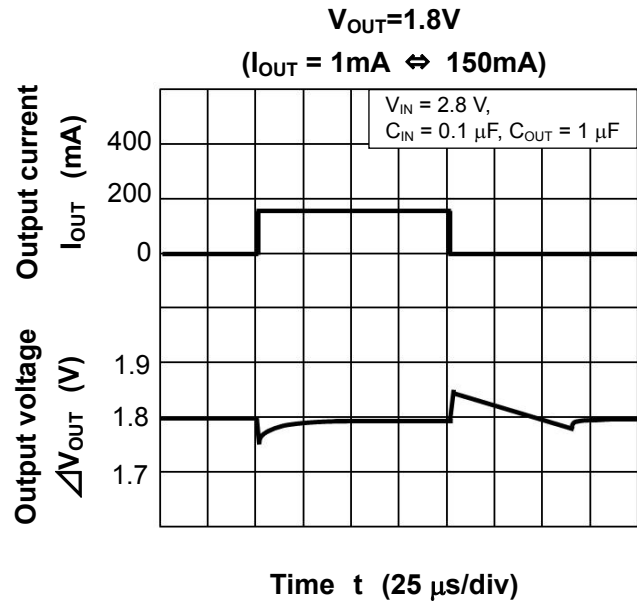
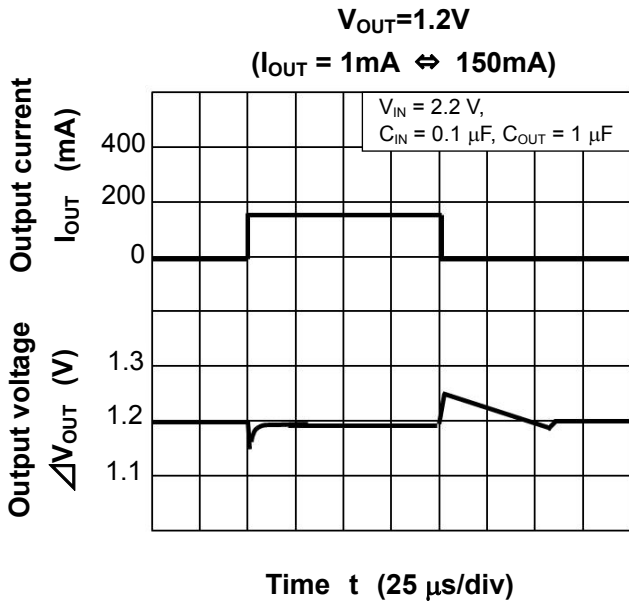

Package Dimensions

SMV (SOT-25)(SC-74A)

Unit: mm

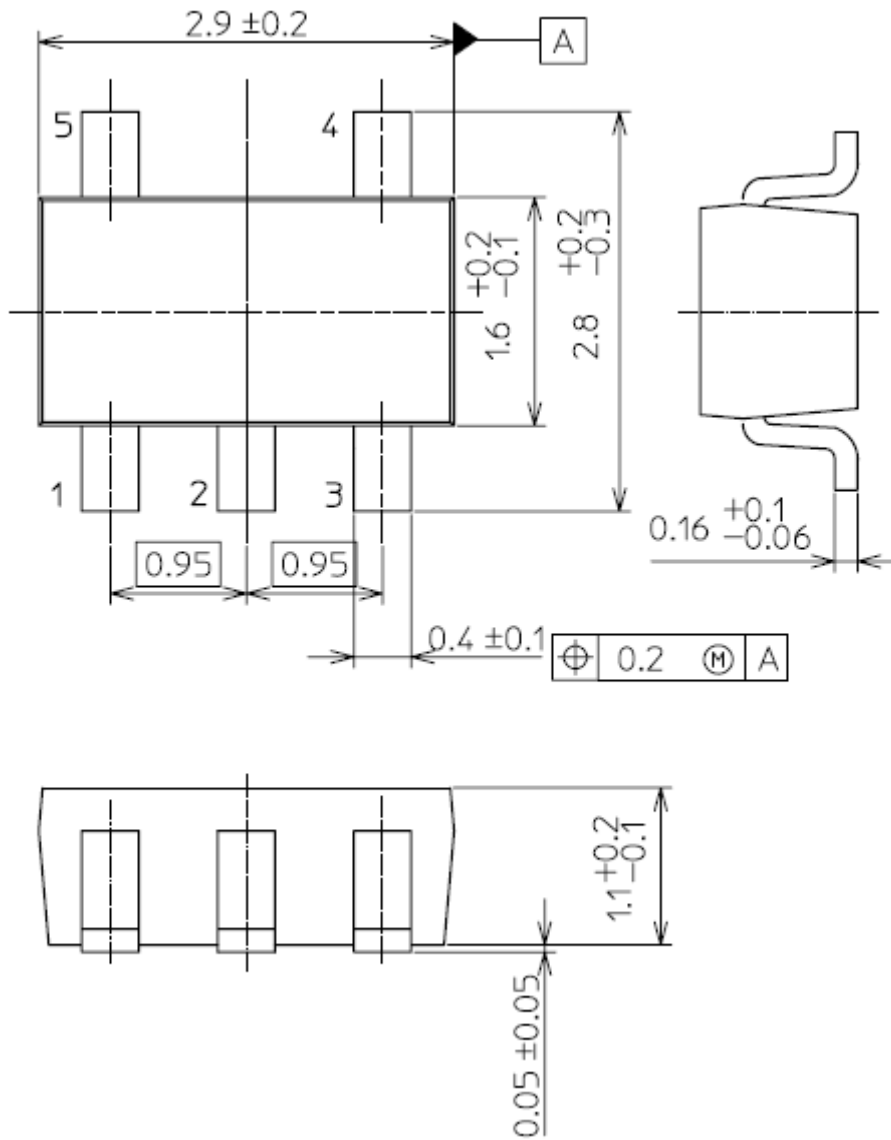

Weight : 16 mg (typ.)

Package Dimensions

ESV (SOT-553)

Unit: mm

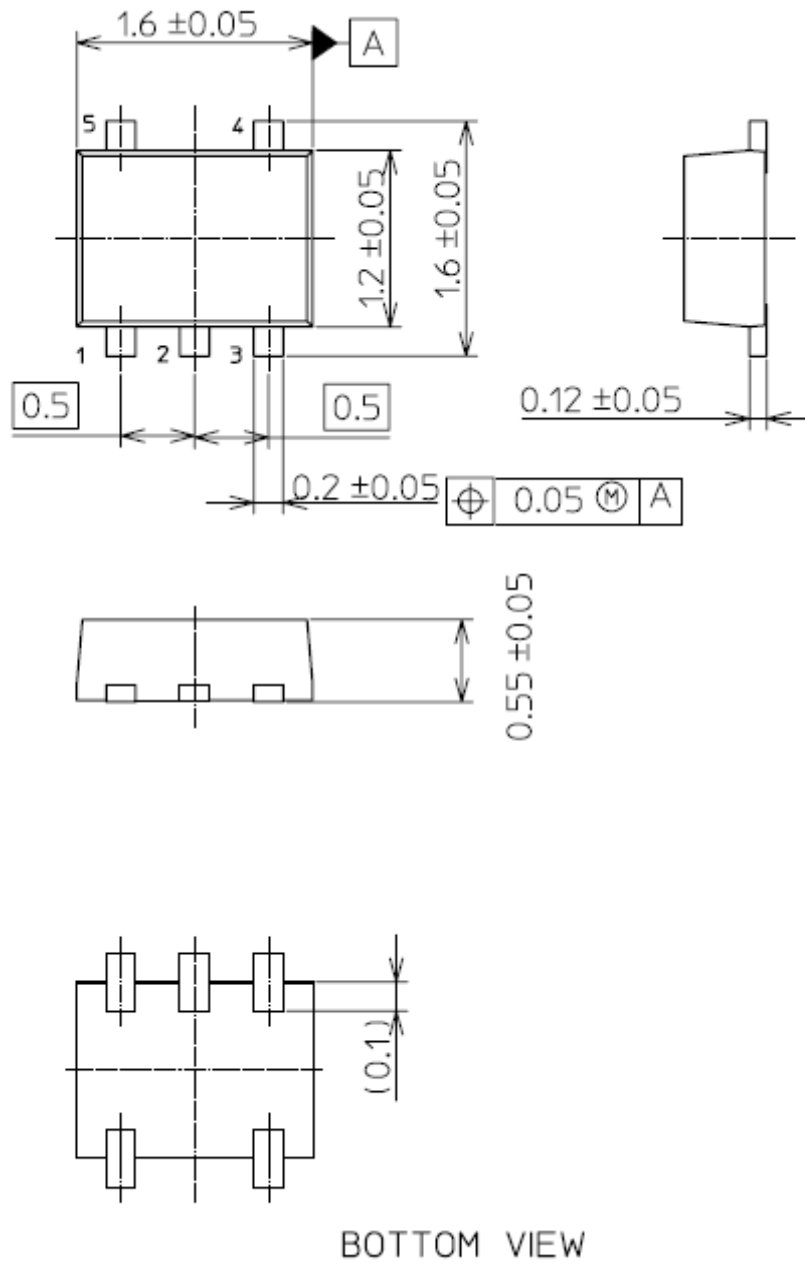

Weight: 3.0 mg (typ.)

**RESTRICTIONS ON PRODUCT USE**

- Toshiba Corporation, and its subsidiaries and affiliates (collectively "TOSHIBA"), reserve the right to make changes to the information in this document, and related hardware, software and systems (collectively "Product") without notice.
- This document and any information herein may not be reproduced without prior written permission from TOSHIBA. Even with TOSHIBA's written permission, reproduction is permissible only if reproduction is without alteration/omission.
- Though TOSHIBA works continually to improve Product's quality and reliability, Product can malfunction or fail. Customers are responsible for complying with safety standards and for providing adequate designs and safeguards for their hardware, software and systems which minimize risk and avoid situations in which a malfunction or failure of Product could cause loss of human life, bodily injury or damage to property, including data loss or corruption. Before customers use the Product, create designs including the Product, or incorporate the Product into their own applications, customers must also refer to and comply with (a) the latest versions of all relevant TOSHIBA information, including without limitation, this document, the specifications, the data sheets and application notes for Product and the precautions and conditions set forth in the "TOSHIBA Semiconductor Reliability Handbook" and (b) the instructions for the application with which the Product will be used with or for. Customers are solely responsible for all aspects of their own product design or applications, including but not limited to (a) determining the appropriateness of the use of this Product in such design or applications; (b) evaluating and determining the applicability of any information contained in this document, or in charts, diagrams, programs, algorithms, sample application circuits, or any other referenced documents; and (c) validating all operating parameters for such designs and applications. **TOSHIBA ASSUMES NO LIABILITY FOR CUSTOMERS' PRODUCT DESIGN OR APPLICATIONS.**
- **PRODUCT IS NEITHER INTENDED NOR WARRANTED FOR USE IN EQUIPMENTS OR SYSTEMS THAT REQUIRE EXTRAORDINARILY HIGH LEVELS OF QUALITY AND/OR RELIABILITY, AND/OR A MALFUNCTION OR FAILURE OF WHICH MAY CAUSE LOSS OF HUMAN LIFE, BODILY INJURY, SERIOUS PROPERTY DAMAGE AND/OR SERIOUS PUBLIC IMPACT ("UNINTENDED USE").** Except for specific applications as expressly stated in this document, Unintended Use includes, without limitation, equipment used in nuclear facilities, equipment used in the aerospace industry, medical equipment, equipment used for automobiles, trains, ships and other transportation, traffic signaling equipment, equipment used to control combustions or explosions, safety devices, elevators and escalators, devices related to electric power, and equipment used in finance-related fields. **IF YOU USE PRODUCT FOR UNINTENDED USE, TOSHIBA ASSUMES NO LIABILITY FOR PRODUCT.** For details, please contact your TOSHIBA sales representative.
- Do not disassemble, analyze, reverse-engineer, alter, modify, translate or copy Product, whether in whole or in part.
- Product shall not be used for or incorporated into any products or systems whose manufacture, use, or sale is prohibited under any applicable laws or regulations.
- The information contained herein is presented only as guidance for Product use. No responsibility is assumed by TOSHIBA for any infringement of patents or any other intellectual property rights of third parties that may result from the use of Product. No license to any intellectual property right is granted by this document, whether express or implied, by estoppel or otherwise.
- **ABSENT A WRITTEN SIGNED AGREEMENT, EXCEPT AS PROVIDED IN THE RELEVANT TERMS AND CONDITIONS OF SALE FOR PRODUCT, AND TO THE MAXIMUM EXTENT ALLOWABLE BY LAW, TOSHIBA (1) ASSUMES NO LIABILITY WHATSOEVER, INCLUDING WITHOUT LIMITATION, INDIRECT, CONSEQUENTIAL, SPECIAL, OR INCIDENTAL DAMAGES OR LOSS, INCLUDING WITHOUT LIMITATION, LOSS OF PROFITS, LOSS OF OPPORTUNITIES, BUSINESS INTERRUPTION AND LOSS OF DATA, AND (2) DISCLAIMS ANY AND ALL EXPRESS OR IMPLIED WARRANTIES AND CONDITIONS RELATED TO SALE, USE OF PRODUCT, OR INFORMATION, INCLUDING WARRANTIES OR CONDITIONS OF MERCHANTABILITY, FITNESS FOR A PARTICULAR PURPOSE, ACCURACY OF INFORMATION, OR NONINFRINGEMENT.**
- Do not use or otherwise make available Product or related software or technology for any military purposes, including without limitation, for the design, development, use, stockpiling or manufacturing of nuclear, chemical, or biological weapons or missile technology products (mass destruction weapons). Product and related software and technology may be controlled under the applicable export laws and regulations including, without limitation, the Japanese Foreign Exchange and Foreign Trade Law and the U.S. Export Administration Regulations. Export and re-export of Product or related software or technology are strictly prohibited except in compliance with all applicable export laws and regulations.
- Please contact your TOSHIBA sales representative for details as to environmental matters such as the RoHS compatibility of Product. Please use Product in compliance with all applicable laws and regulations that regulate the inclusion or use of controlled substances, including without limitation, the EU RoHS Directive. **TOSHIBA ASSUMES NO LIABILITY FOR DAMAGES OR LOSSES OCCURRING AS A RESULT OF NONCOMPLIANCE WITH APPLICABLE LAWS AND REGULATIONS.**



# Mouser Electronics

Authorized Distributor

Click to View Pricing, Inventory, Delivery & Lifecycle Information:

[Toshiba:](#)

[TCR2EE18,LM\(CT](#)