

SSRDIN/SPST, 10 - 40 Amp Rating

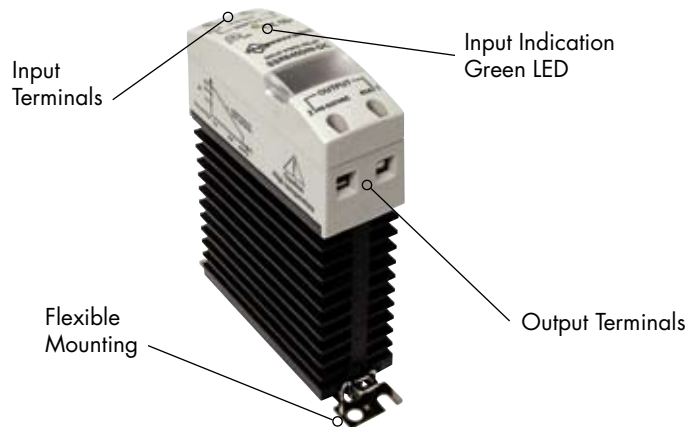

General Specifications (@ 25° C) (UL 508)

Output Characteristics		Units	SSR210DIN-AC	SSR225DIN-AC
Number and type of Contacts			SPST-NO	SPST-NO
Switching Device			SCR (2)	SCR (2)
Current rating		A	10	25
Switching voltage		V	24....280 AC	24....280 AC
Switching Type			Zero Cross	Zero Cross
Maximum zero turn-on voltage (Vpk)		V	35	35
Maximum Rate of Rise Off State Voltage (dv/dt)		V/us	500	500
Incandescent Lamp Ampere Rating (rms)		A	8	16
Motor Load Rating (rms)		A	4.5	8
Min. Load current to maintain on		mA	50	120
Non-Repetitive Surge Current (1 cycle)		A	83	800
Max. RMS overload current (1 second)		A	24	40
Max. Off state leakage current (rms)		mA	10	10
Typical On State Voltage Drop (rms)		V	1.25 AC	1.35 AC
Max. On State Voltage Drop (rms)		V	1.6 AC	1.8 AC
Maximum I ² T for Fusing (A ²)			83	3700
Input Characteristics				
Voltage Range		V	90....280 AC, 80....140 DC	90....280 AC, 80....140 DC
Must Release Voltage		V	10 AC	10 AC
Nominal Input Impedance		Ω	16....25K	16....25K
Typical Input Current @ 5VDC or 240VAC		mA	12	12
Reverse Polarity Protection			N/A	N/A
Performance Characteristics				
Operating time (response time)	On	ms	8.3	8.3
	Off	ms	8.3	8.3
Rated insulation voltage		V	4000 AC	4000 AC
Dielectric strength		V	4000 AC	4000 AC
Environment				
Product certifications			UL, CSA, CE	UL, CSA, CE
Ambient air temperature around the device	Storage	°C	-40...+100	-40...+100
	Operation	°C	-30...+80	-30...+80
Degree of protection			IP 20	IP 20
Miscellaneous Characteristics				
Thermal Resistance (Junction to Case)		°C/W	1.5	0.43
Integral Heat sink		°C/W	2.2	2.2
Weight		g (oz)	320 (11.3)	326 (11.5)
LED			Green	Green
Terminal Wire Capacity		AWG (mm ²)	8 (10)	8 (8.4)
Terminal Torque (maximum)		in lb (Nm)	12.5 (1.4)	12.5 (1.4)

SECTION 4



SSR240DIN-AC	SSR610DIN-AC	SSR625DIN-AC	SSR640DIN-AC
SPST-NO	SPST-NO	SPST-NO	SPST-NO
SCR (2)	SCR (2)	SCR (2)	SCR (2)
40	10	25	40
24....280 AC	48....600 AC	48....600 AC	48....600 AC
Zero Cross	Zero Cross	Zero Cross	Zero Cross
35	35	35	35
500	200	700	500
20	8	16	20
14	4.5	8	14
250	80	250	250
800	83	1000	800
100	24	50	100
10	10	10	10
1.6 AC	1.25 AC	1.35 AC	1.6 AC
1.6 AC	1.6 AC	1.6 AC	1.6 AC
3700	83	1700	3700
90....280 AC, 80....140 DC	90....280 AC, 80....140 DC	90....280 AC, 80....140 DC	90....280 AC, 80....140 DC
10 AC	10 AC	10 AC	10 AC
13K	16....25K	16....25K	13K
16	12	12	16
N/A	N/A	N/A	N/A
10	8.3	8.3	10
10	8.3	8.3	10
4000 AC	4000 AC	4000 AC	4000 AC
4000 AC	4000 AC	4000 AC	4000 AC
UL, CSA, CE	UL, CSA, CE	UL, CSA, CE	UL, CSA, CE
-40...+100	-40...+100	-40...+100	-40...+100
-30...+80	-30...+80	-30...+80	-30...+80
IP 20	IP 20	IP 20	IP 20
0.43	1.8	0.43	0.43
2.2	2.2	2.2	2.2
332 (11.7)	320 (11.3)	326 (11.5)	332 (11.7)
Green	Green	Green	Green
8 (10)	8 (10)	8 (10)	8 (10)
12.5 (1.4)	12.5 (1.4)	12.5 (1.4)	12.5 (1.4)

SSRDIN/SPST, 10 - 40 Amp Rating *continued*

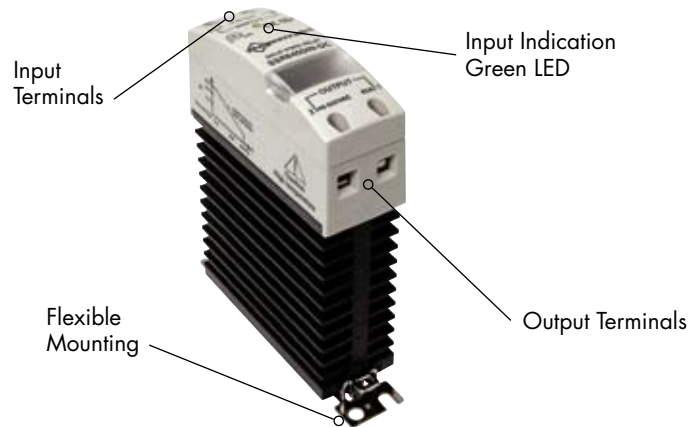

General Specifications (@ 25° C) (UL 508)

Output Characteristics		Units	SSR210DIN-DC	SSR225DIN-DC
Number and type of Contacts			SPST-NO	SPST-NO
Switching Device			SCR (2)	SCR (2)
Current rating		A	10	25
Switching voltage		V	24...280 AC	24...280 AC
Switching Type			Zero Cross	Zero Cross
Maximum zero turn-on voltage (Vpk)		V	35	35
Maximum Rate of Rise Off State Voltage (dv/dt)		V/us	200	500
Incandescent Lamp Ampere Rating (rms)		A	8	16
Motor Load Rating (rms)		A	4.5	8
Min. Load current to maintain on		mA	50	120
Non-Repetitive Surge Current (1 cycle)		A	83	800
Max. RMS overload current (1 second)		A	24	40
Max. Off state leakage current (rms)		mA	10	10
Typical On State Voltage Drop (rms)		V	1.25 AC	1.25 AC
Max. On State Voltage Drop (rms)		V	1.6 AC	1.6 AC
Maximum I ² T for Fusing (A ²)			83	3700
Input Characteristics				
Voltage Range		V	3...32	3...32
Must Release Voltage		V	1 DC	1 DC
Nominal Input Impedance		Ω	Current Regulator	Current Regulator
Typical Input Current @ 5VDC or 240VAC		mA	16	16
Reverse Polarity Protection			Yes	Yes
Performance Characteristics				
Operating time (response time)	On	ms	8.3	8.3
	Off	ms	8.3	8.3
Rated insulation voltage	Input to Output	V	4000 AC	4000 AC
Dielectric strength	Terminals to Chassis	V	4000 AC	4000 AC
Environment				
Product certifications			UL, CSA, CE	UL, CSA, CE
Ambient air temperature around the device	Storage	°C	-40...+100	-40...+100
	Operation	°C	-30...+80	-30...+80
Degree of protection			IP 20	IP 20
Miscellaneous Characteristics				
Thermal Resistance (Junction to Case)		°C/W	1.5	0.43
Integral Heat sink		°C/W	2.2	2.2
Weight		g (oz)	320 (11.3)	326 (11.5)
LED		Input	Green	Green
Terminal Wire Capacity		AWG (mm ²)	8 (10)	8 (10)
Terminal Torque (maximum)		in lb (Nm)	12.5 (1.4)	12.5 (1.4)



SSR240DIN-DC	SSR610DIN-DC	SSR625DIN-DC	SSR640DIN-DC
SPST-NO	SPST-NO	SPST-NO	SPST-NO
SCR (2)	SCR (2)	SCR (2)	SCR (2)
40	10	25	40
24....280 AC	48....600 AC	48....600 AC	48....600 AC
Zero Cross	Zero Cross	Zero Cross	Zero Cross
35	35	35	35
500	200	700	500
20	8	16	20
14	4.5	8	14
250	80	250	250
800	83	1000	800
100	24	50	100
10	10	10	10
1.6 AC	1.25 AC	1.35 AC	1.6 AC
1.6 AC	1.6 AC	1.6 AC	1.6 AC
3700	83	1700	3700
3....32	3....32	3....32	3....32
1 DC	1 DC	1 DC	1 DC
Current Regulator	Current Regulator	Current Regulator	Current Regulator
16	16	16	16
Yes	Yes	Yes	Yes
10	8.3	8.3	10
10	8.3	8.3	10
4000 AC	4000 AC	4000 AC	4000 AC
4000 AC	4000 AC	4000 AC	4000 AC
UL, CSA, CE	UL, CSA, CE	UL, CSA, CE	UL, CSA, CE
-40...+100	-40...+100	-40...+100	-40...+100
-30...+80	-30...+80	-30...+80	-30...+80
IP 20	IP 20	IP 20	IP 20
0.43	1.8	0.43	0.43
2.2	2.2	2.2	2.2
332 (11.7)	320 (11.3)	326 (11.5)	332 (11.7)
Green	Green	Green	Green
8 (10)	8 (10)	8 (10)	8 (10)
12.5 (1.4)	12.5 (1.4)	12.5 (1.4)	12.5 (1.4)

SSRDIN/SPST, 10 - 40 Amp Rating *continued*

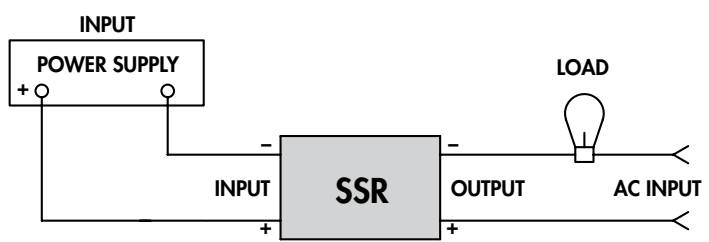
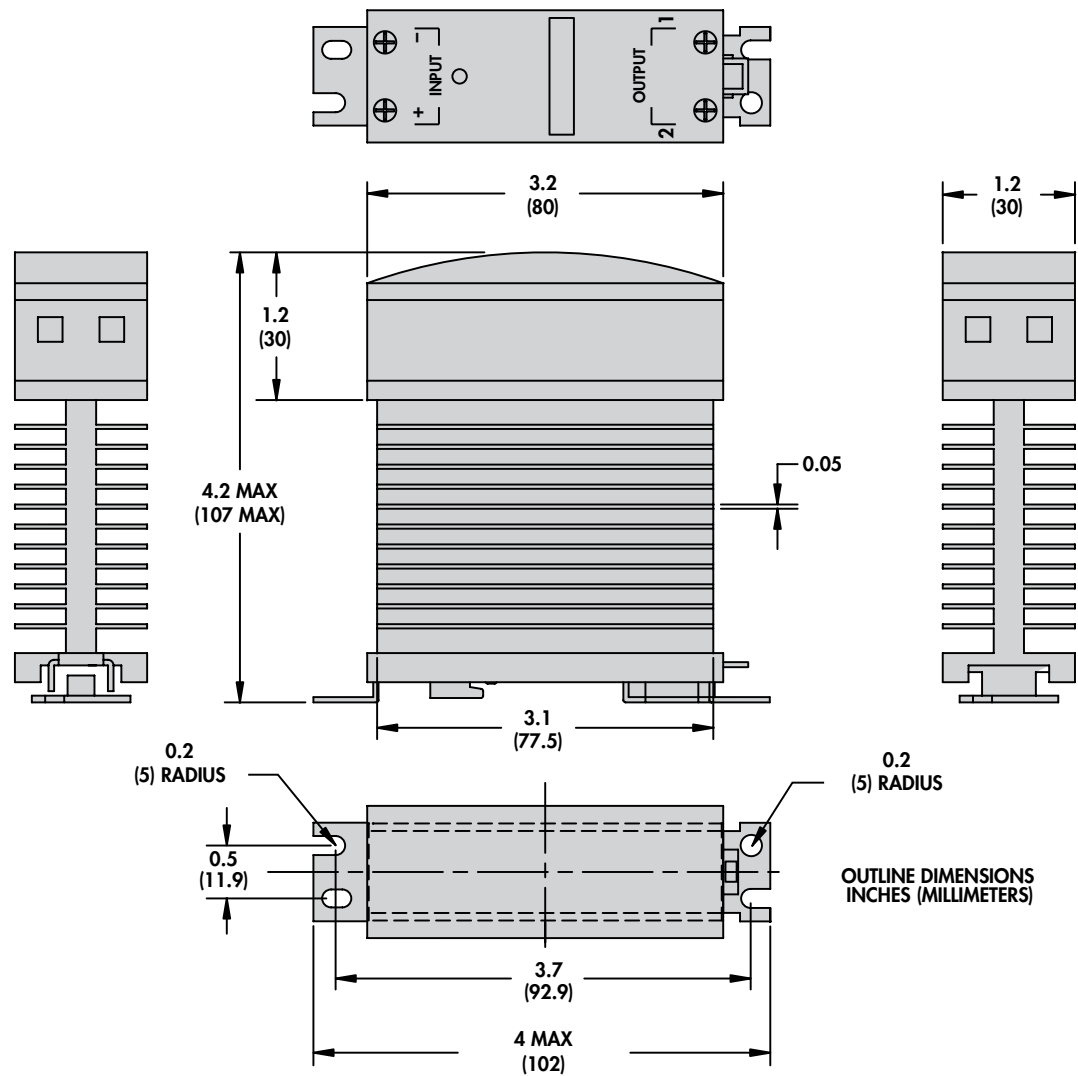
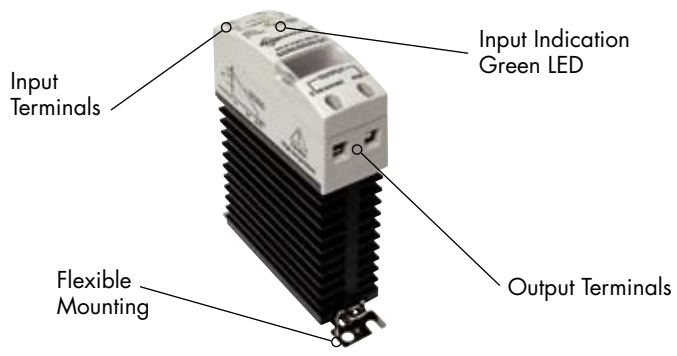

WIRING DIAGRAM

SECTION 4

Standard Part Numbers

BOLD-FACED PART NUMBERS ARE NORMALLY STOCKED

AC Operated	Input Voltage Range	Output Voltage Range	Contact Configuration	Switching Type	Rated Current Load (Amps)
SSR210DIN-AC	90...280 VAC	24...280 VAC	SPST-NO	Zero Cross	10
SSR225DIN-AC	90...280 VAC	24...280 VAC	SPST-NO	Zero Cross	25
SSR240DIN-AC	90...280 VAC	24...280 VAC	SPST-NO	Zero Cross	40
SSR610DIN-AC	90...280 VAC	48...600 VAC	SPST-NO	Zero Cross	10
SSR625DIN-AC	90...280 VAC	48...600 VAC	SPST-NO	Zero Cross	25
SSR640DIN-AC	90...280 VAC	48...600 VAC	SPST-NO	Zero Cross	40
SSR210DIN-AC-2	90...280 VAC	24...280 VAC	SPST-NO	Random	10
SSR210DIN-AC-4	90...280 VAC	24...280 VAC	SPST-NC	Random	10
SSR225DIN-AC-2	90...280 VAC	24...280 VAC	SPST-NO	Random	25
SSR225DIN-AC-4	90...280 VAC	24...280 VAC	SPST-NC	Random	25
SSR610DIN-AC-2	90...280 VAC	48...600 VAC	SPST-NO	Random	10
SSR610DIN-AC-4	90...280 VAC	48...600 VAC	SPST-NC	Random	10
SSR625DIN-AC-2	90...280 VAC	48...600 VAC	SPST-NO	Random	25
SSR625DIN-AC-4	90...280 VAC	48...600 VAC	SPST-NC	Random	25
DC Operated					
SSR210DIN-DC	3...32 VDC	24...280 VAC	SPST-NO	Zero Cross	10
SSR225DIN-DC	3...32 VDC	24...280 VAC	SPST-NO	Zero Cross	25
SSR240DIN-DC	3...32 VDC	24...280 VAC	SPST-NO	Zero Cross	40
SSR610DIN-DC	3...32 VDC	48...600 VAC	SPST-NO	Zero Cross	10
SSR625DIN-DC	3...32 VDC	48...600 VAC	SPST-NO	Zero Cross	25
SSR640DIN-DC	3...32 VDC	48...600 VAC	SPST-NO	Zero Cross	40
SSR210DIN-DC-2	3...32 VDC	24...280 VAC	SPST-NO	Random	10
SSR210DIN-DC-4	3...32 VDC	24...280 VAC	SPST-NC	Random	10
SSR225DIN-DC-2	3...32 VDC	24...280 VAC	SPST-NO	Random	25
SSR225DIN-DC-4	3...32 VDC	24...280 VAC	SPST-NC	Random	25
SSR610DIN-DC-2	3...32 VDC	48...600 VAC	SPST-NO	Random	10
SSR610DIN-DC-4	3...32 VDC	48...600 VAC	SPST-NC	Random	10
SSR625DIN-DC-2	3...32 VDC	48...600 VAC	SPST-NO	Random	25
SSR625DIN-DC-4	3...32 VDC	48...600 VAC	SPST-NC	Random	25

Part Number Builder

Series	Output Voltage	Output Current	Input Voltage
SSR	2 = 24 to 280 VAC	10 = 10 AMPS	DIN-DC = 3 - 32 VDC; SPST-NO; Zero Cross
	6 = 48 to 600 VAC	25 = 25 AMPS	DIN-DC-2 = 3 - 32 VDC; SPST-NO; Random
		40 = 40 AMPS	DIN-DC-4 = 3 - 32 VDC; SPST-NC; Random
			DIN-AC = 90 - 280 VAC; SPST-NO; Zero Cross
			DIN-AC-2 = 90 - 280 VAC; SPST-NO; Random
			DIN-AC-4 = 90 - 280 VAC; SPST-NC; Random

10 AMP MODELS

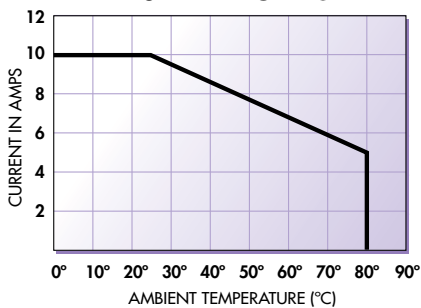

25 AMP MODELS

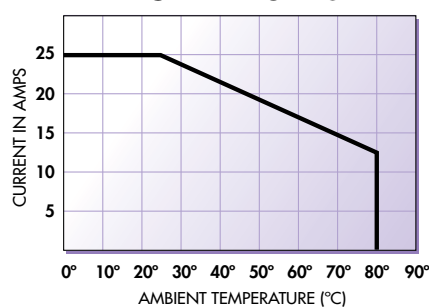

40 AMP MODELS

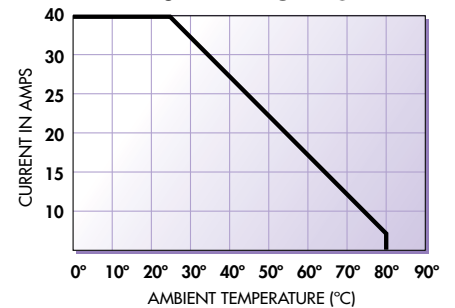

Mouser Electronics

Authorized Distributor

Click to View Pricing, Inventory, Delivery & Lifecycle Information:

Schneider Electric:

[SSR610DIN-DC](#) [SSR230DIN-AC22](#) [SSR210DIN-AC](#) [SSR610DIN-AC](#) [SSR240DIN-AC](#) [SSR225DIN-AC](#)
[SSR210DIN-AC22](#) [SSR220DIN-AC22](#) [SSR625DIN-DC](#) [SSR640DIN-AC](#) [SSRPTDC10](#) [SSR630DIN-AC22](#)
[SSR240DIN-DC](#) [SSR610DIN-AC22](#) [SSR620DIN-AC22](#) [SSRDAC20](#) [SSRPTAC25](#) [SSRDAC10](#) [SSR625DIN-AC](#)
[SSRDAC10](#) [SSR610DIN-DC22](#) [SSR225DIN-DC](#) [SSRDAC20](#) [SSR630DIN-DC22](#) [SSR245DIN-AC45](#) [SSR620DIN-](#)
[DC22](#) [SSRPTAC10](#) [SSR310DIN-DC22](#) [SSRPTDC25](#) [SSR645DIN-DC45](#)