

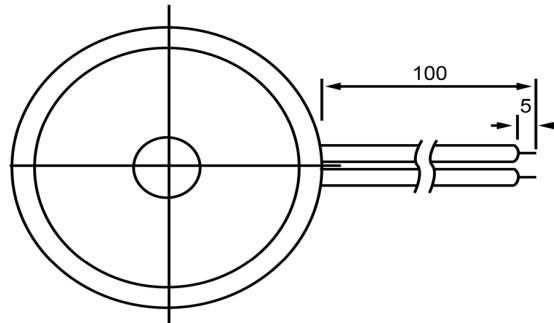

TOP VIEW

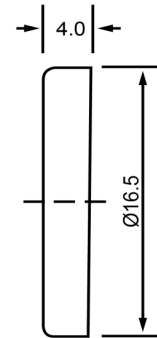

SIDE VIEW



Specifications			Notes	Revision History						
Description	Value	Unit		Version	Description		Date	Approved		
Technology	Piezo		1) All dimensions are in mm unless otherwise noted 2) All parts meet RoHS	1	Released from Engineering		10/21/2013	J.S		
Resonant Frequency	4,000	(Hz)								
Rated Voltage	9	(V)								
SPL @ 10cm	80	(dBA)								
Capacitance	9,500	(pF)								
Mount Type	Flush									
Voltage Range	1 ~ 25	(V)								
Max Rated Current	7	(mA)								
Housing Material	ABS									
Operating Temperature	-20 ~ +60	°C								
Storage Temperature	-20 ~ +60	°C								
Weight	1	(g)								
 DB UNLIMITED			 Piezo Transducer			TP164009-1				

Additional considerations can be found at www.dbunlimitedco.com/technical-articles.