

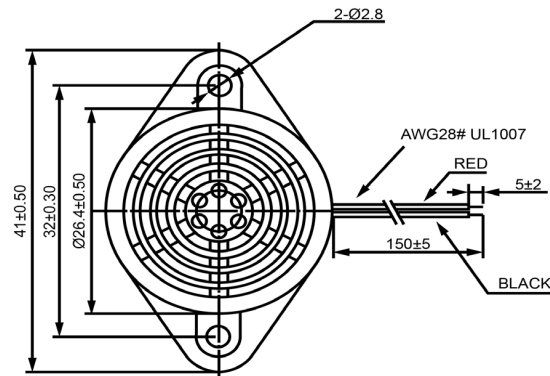

TOP VIEW

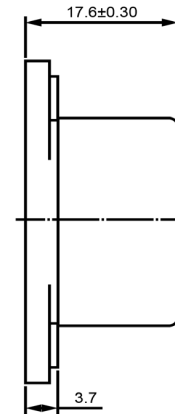

SIDE VIEW



Specifications			Notes	Revision History						
Description	Value	Unit		Version	Description		Date	Approved		
Technology	Electro-Mechanical		1) All dimensions are in mm unless otherwise noted 2) All parts meet RoHS	1	Released from Engineering		10/21/2013	J.S		
Resonant Frequency	400	(Hz)								
Rated Voltage	12	(V)								
SPL @ 10cm	95	(dBA)								
Tone	Single									
Mount Type	Flange Mount									
Voltage Range	7 ~ 16	(V)								
Max Rated Current	23	(mA)								
Housing Material	ABS									
Operating Temperature	-20 ~ +60	°C								
Storage Temperature	-30 ~ +70	°C								
Weight	17	(g)								
 DB UNLIMITED			 DB UNLIMITED			Electro-Mechanical Indicator		IE260412-3		
						Drawn by A.B.	Date 10/21/2013	Checked by C.E.	Date 10/21/2013	Approved by J.S

Additional considerations can be found at www.dbunlimitedco.com/technical-articles.