

DESIGN AND COMPACT CASES

GUARDBOX 33

Product description

MAIN FEATURES

The Guardbox 33 is an aluminum enclosure with a timeless design in various sizes and executions. In addition to handiness, shape and color, it impresses with its robust construction. Even in the standard version of the box with ventilation slots, it achieves IP30 and can be upgraded to IP65 without openings (protected against dust and water jets). The enclosure also offers excellent EMC shielding.

- › Sturdy
- › Different sizes | scalable depth
- › No visible screws
- › Optional EMC shielding
- › Heat dissipation with optional ventilation slots
- › Mounting kits for Eurocards
- › Checked for shock and vibration according to EN50155 | EN61373
- › Adjustable folding feet
- › Optional handles

PRODUCT VARIETY

- Standard versions (6 different sizes)
- IP54 combined with EMC protection
- IP65

POSSIBLE CUSTOMIZATIONS

- Depth
- Different colors
- Handles
- Special mounting options
(e.g. wall mounting or installation)

GUARDBOX 33



TYPICAL APPLICATIONS

- Test and measurement equipment
- Laboratory and service equipment
- Equipment on train, trams, etc.

DESIGN AND COMPACT CASES

GUARDBOX 33

Executions

SIZES

- Enclosure 0: 129.5 x 55 mm
- Enclosure 1: 129.5 x 71.5 mm
- Enclosure 2: 230.5 x 55 mm
- Enclosure 3: 230.5 x 89 mm
- Enclosure 4: 183.5 x 111 mm
- Enclosure 5: 230.5 x 41 mm

Tailored to customers needs, the Guardbox 33 is available in six different sizes.

EXECUTIONS

STANDARD

Scope of delivery:

- EMC level basic plus+
- Top and bottom extrusions as well as front panels have conductive connections (this protects electronics from interference)

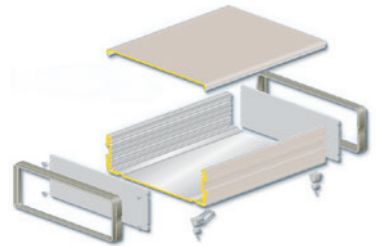
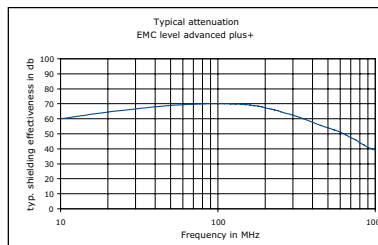

EMC PROTECTION

Scope of delivery:

- EMC level advanced
- Standard enclosure and EMC gasket set
- EMC enclosure for demanding applications

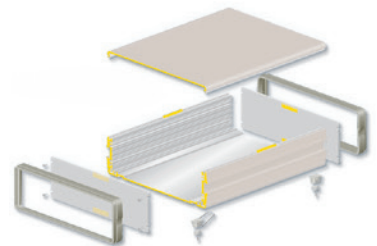
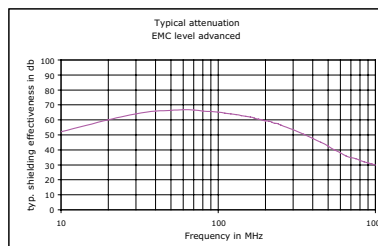

IP54 AND EMC PROTECTION

Scope of delivery:

- EMC level advanced plus+
- Standard enclosure and IP54 / EMC set
- EMC enclosure for demanding applications
- Protects electronics from splash water and dust

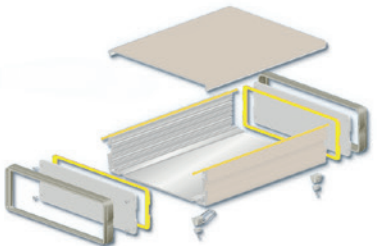
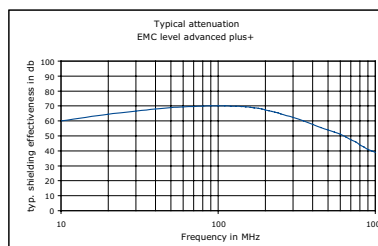

IP65

Scope of delivery:

- Protects electronics against dust and water jets from all directions

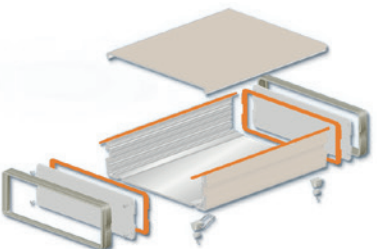

DESIGN AND COMPACT CASES

GUARDBOX 33

Executions

COLOR (POWDER COATING)

- Bottom and cover: Light gray (RAL 7035), black (RAL 9005), stone gray (RAL 7032), other colors on request (MOQ: 10 pieces, no stock)
- Frame: Light gray (RAL 7035), black (RAL 9011), stone gray (RAL 7030)

COMPLETE ENCLOSURE SETS

Complete enclosure with EMC base level. The sets contain all necessary parts.

Scope of delivery:

- 1 basic enclosure without air perforation
- 2 frames
- 2 front / rear panels without air perforation
- 1 set assembly material

Enclosure	Color	Depth			
		120 mm 4.72"	180 mm 7.08"	240 mm 9.44"	300 mm 11.81"
0	Black	33E012-25	33E018-25	33E024-25	-
0	Light gray	33E012-45	33E018-45	33E024-45	-
1	Black	33E112-25	33E118-25	33E124-25	-
1	Light gray	33E112-45	33E118-45	33E124-45	-
2	Black	-	-	33E224-25	33E230-25
2	Light gray	-	-	33E224-45	33E230-45
3	Black	-	-	33E324-25	33E330-25
3	Light gray	-	-	33E324-45	33E330-45
4	Black	-	33E418-25	33E424-25	33E430-25
4	Light gray	-	33E418-45	33E424-45	33E430-45
5	Black	-	33E518-25	33E524-25	-
5	Light gray	-	33E518-45	33E524-45	-



DESIGN AND COMPACT CASES

GUARDBOX 33

Product structure

CONFIGURATION

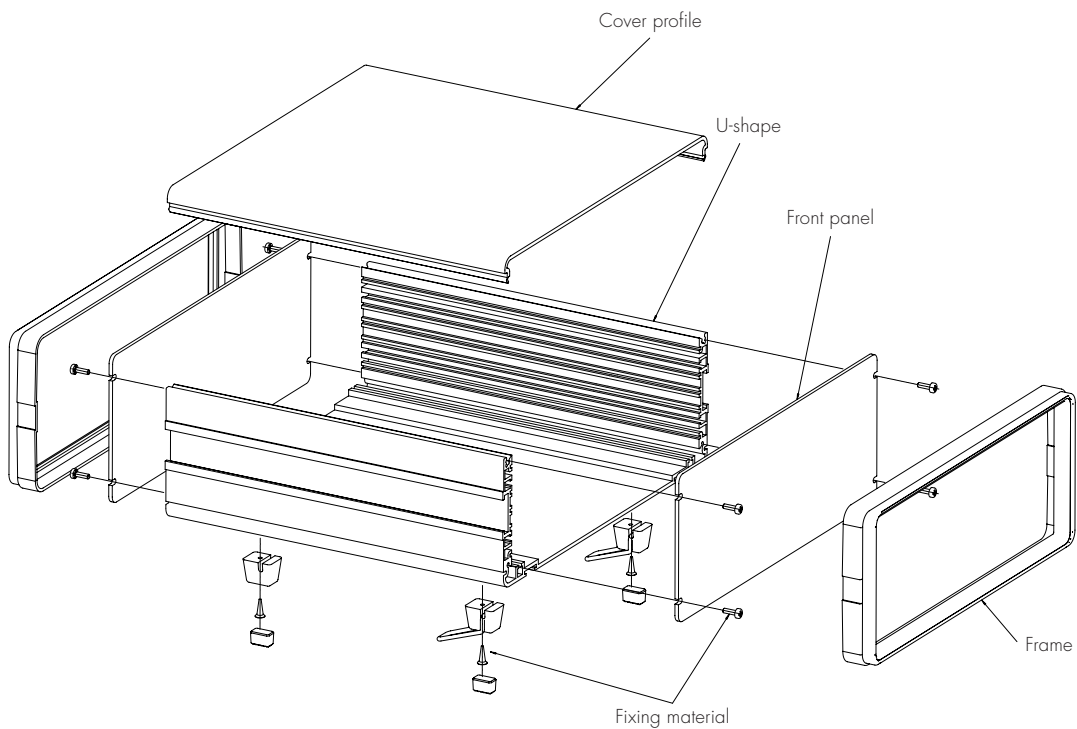
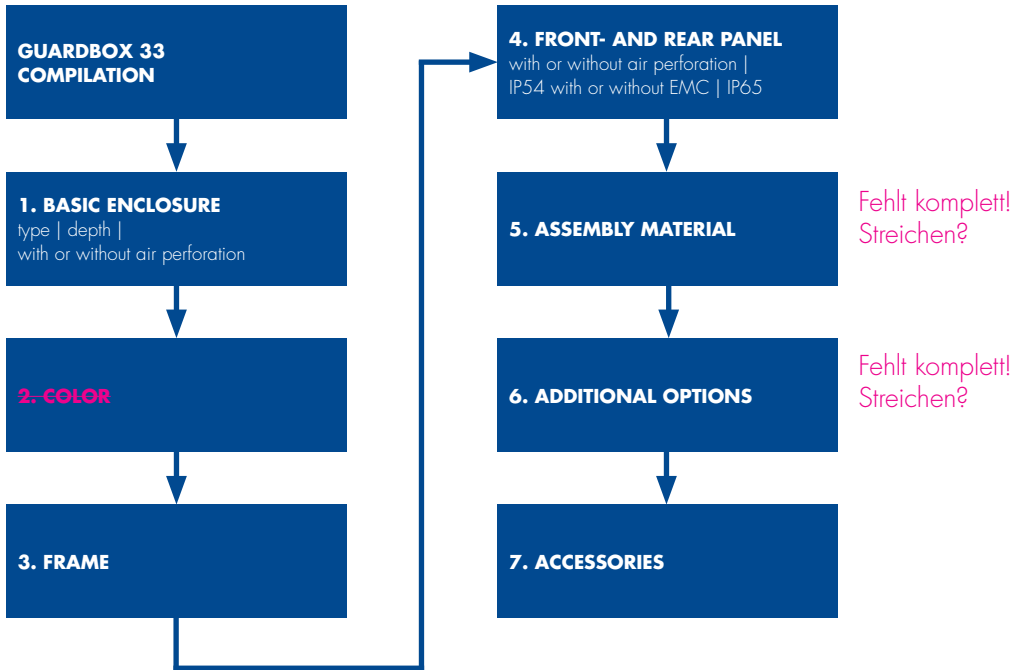

DESIGN AND COMPACT CASES

GUARDBOX 33

Product structure

BASIC ENCLOSURE

- Aluminum profile
- Powder coated
- With or without air perforation slots in bottom

Scope of delivery:

- 1 U-shaped bottom
- 1 cover

Basic enclosure light gray:

Enclosure	Without air perforation				With air perforation		
	Depth mm	120	180	240	300	240	300
Depth inch	4.72	7.08	9.44	11.81	9.44	11.81	
0	33E717	33E721	33E725				
1	33E705	33E709	33E713				
2			33E733	33E737	33E734	33E738	
3			33E757	33E761	33E758	33E762	
4		33E777	33E781	33E785	33E782	33E786	
5		33E741	33E744				

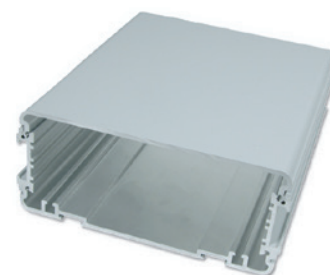

Basic enclosure black:

Enclosure	Without air perforation				With air perforation		
	Depth mm	120	180	240	300	240	300
Depth inch	4.72	7.08	9.44	11.81	9.44	11.81	
0	33E717-06	33E721-06	33E725-06				
1	33E705-06	33E709-06	33E713-06				
2			33E733-06	33E737-06	33E734-06	33E738-06	
3			33E757-06	33E761-06	33E758-06	33E762-06	
4		33E777-06	33E781-06	33E785-06	33E782-06	33E786-06	
5		33E741-06	33E744-06				

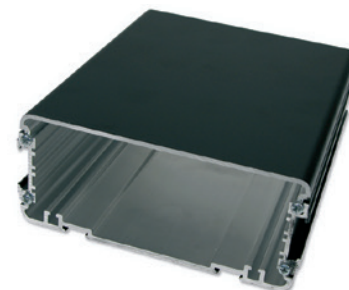

Basic enclosure stone gray:

Enclosure	Without air perforation				With air perforation		
	Depth mm	120	180	240	300	240	300
Depth inch	4.72	7.08	9.44	11.81	9.44	11.81	
0	33E717-00	33E721-00	33E725-00				
1	33E705-00	33E709-00	33E713-00				
2			33E733-00	33E737-00	33E734-00	33E738-00	
3			33E757-00	33E761-00	33E758-00	33E762-00	
4		33E777-00	33E781-00	33E785-00	33E782-00	33E786-00	
5		33E741-00	33E744-00				

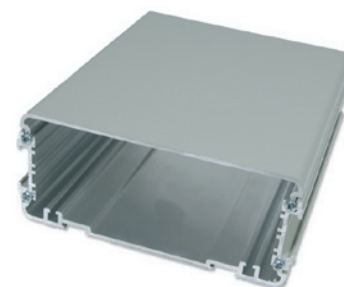

DESIGN AND COMPACT CASES

GUARDBOX 33

FRAME

- Protects the entire enclosure
- High quality plastic, UL94 V-0

Scope of delivery:

- 1 plastic frame
- For one Guardbox two frames have to be ordered



Enclosure	Light gray	Black	Stone gray
0	33-000-03	33-000-06	33-000
1	33-001-03	33-001-06	33-001
2	33-002-03	33-002-06	33-002
3	33-003-03	33-003-06	33-003
4	33-004-03	33-004-06	33-004
5	33-005-03	33-005-06	33-005

FRONT / REAR PANEL

- Front / rear panel of 2.5 mm (0.9") anodised aluminum
- Screwed on the front of the enclosure profiles (give the frame a required stability)
- With or without air perforation
- IP54 / EMC protection and IP65

Scope of delivery:

- 1 front / rear panel with or without air perforation (for one Guardbox 33 two front / rear panels have to be ordered)
- IP54 / EMC protection and IP65 set: 1 front | 1 rear panel, 2 self-adhesive seals, sealing hose, washers
- Torque of mounting screws (IP protection): 0.7 to 0.75 Nm

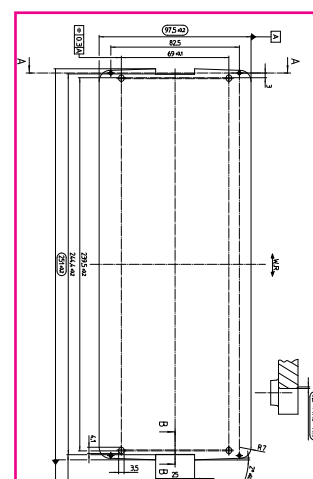
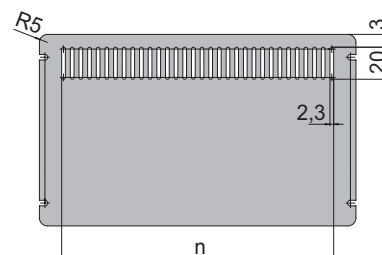

Zeichnung entspricht nicht der Tabelle! Mit Urs klären!

Enclosure	Without air perforation	With air perforation	Without air perforation IP65	Without air perforation IP54 / EMC
EMC level	Basic advanced	Basic	-	Advanced plus
0	33E400-50	33E400-51	33-520	33E520
1	33E401-50		33-521	33E521
2	33E402-50	33E402-51	33-522	33E522
3	33E403-50	33E403-51	33-523	33E523
4	33E404-50	33E404-51	33-524	33E524
5	33E405-50		33-525	33E525

Enclosure	A		B		C		D		n	
	mm	inch	mm	inch	mm	inch	mm	inch	mm	inch
0	142.3	5.60	63.5	2.50	137.0	5.39	35	1.37	126.5	4.98
1	142.3	5.60	80	3.14	137.0	5.39	51.5	2.02		
2	243.3	9.57	63.5	2.50	238.4	9.38	35	1.37	212.9	8.38
3	244.4	9.62	97.5	3.83	238.4	9.38	69	2.71	212.9	8.38
4	197.5	7.77	119.5	4.70	190.6	7.50	91	3.58	169.7	6.68
5	243.3	9.57	49.5	1.94	238.4	9.38	21	0.82		

DESIGN AND COMPACT CASES

GUARDBOX 33

Product structure

REPLACEMENT SEALS IP54 / EMC

- Foamed plastic conductive PET-PU black, UL94 V-0
- Self-adhesive seals

Enclosure	Part-No.
0	33E510
1	33E511
2	33E512
3	33E513
4	33E514

REPLACEMENT SEALS IP65

- Foamed plastic PCV gray, UL94 V-0
- Self-adhesive seals

Enclosure	Part-No.
0	33-510
1	33-511
2	33-512
3	33-513
4	33-514

Enclosure	A		B		C		D		E		F		G		H	
	mm	inch	mm	inch	mm	inch	mm	inch	mm	inch	mm	inch	mm	inch	mm	inch
0	149	5.86	130	5.11	137	5.39	138	5.43	64.5	2.53	35	1.37	52.5	2.06	R6.5	0.25
1	149	5.86	130	5.11	137	5.39	138	5.43	81	3.18	51.5	2.02	69	2.71	R6.5	0.25
2	250	9.84	231	9.09	239	9.40	239	9.40	64.5	2.53	35	1.37	52.5	2.06	R7	0.27
3	251	9.88	231	9.09	239	9.40	240	9.44	98	3.85	69	2.71	86	3.38	R7	0.27
4	204	8.03	184	7.24	191	7.51	193	7.59	120.5	4.74	91	3.58	108.5	4.27	R7.5	0.29
5	249.5	9.82	231	9.09	239	9.40	239	9.40	50	1.96	21	0.82	38	1.49	R7	0.27

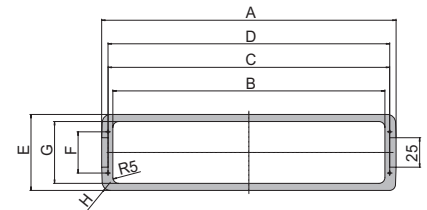
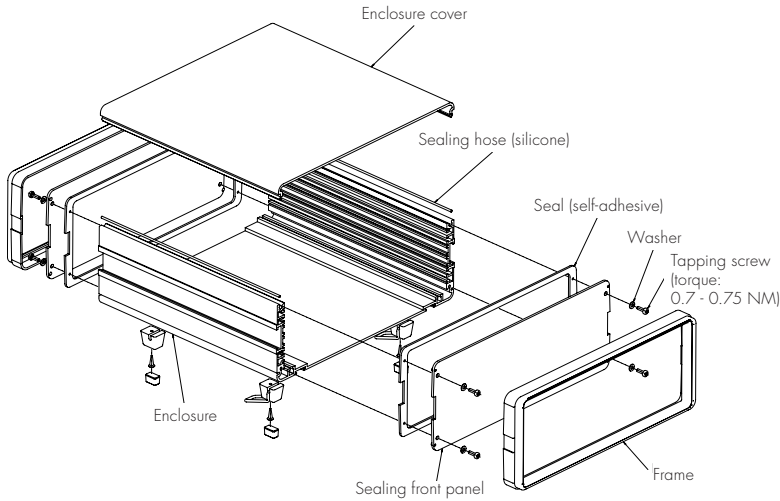

DESIGN AND COMPACT CASES

GUARDBOX 33

Accessories

ASSEMBLY MATERIAL

- One set with all necessary materials for mounting one Guardbox 33

Scope of delivery:

- 4 feet (2 folding feet, UL94 V-0) incl. screws
- 4 tapping screws to assemble the enclosure
- Assembly material for internal extension (10 screws M3 x 8, 10 screw nut M3, 10 nut holders)

Enclosure	Light gray	Black	Stone gray
0 - 4	33-640	33-620	33-621
5	33-641	33-624	33-622

ASSEMBLY INSTRUCTIONS

Scope of delivery:

- Detailed assembly instruction (1 page)

Description	Part-No.
EMC protection	33E100
Standard, IP65 and IP54 / EMC protection	33-200

SUPPLEMENTARY EMC GASKET SET

- For EMC level advanced, when using no air perforations
- For EMC level basic, when using air perforations
- Increased EMC level by approximate 10 dB

Scope of delivery:

- 4 beryllium-cooper contact strips
- 2 stainless steel springs

Enclosure	Description	Part-No.
0 - 5	Increased by approx. 10 dB	33-642

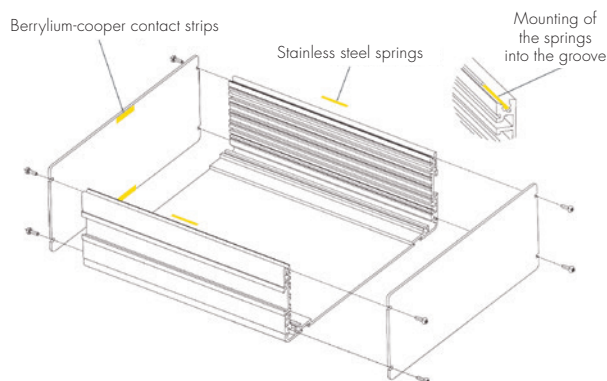
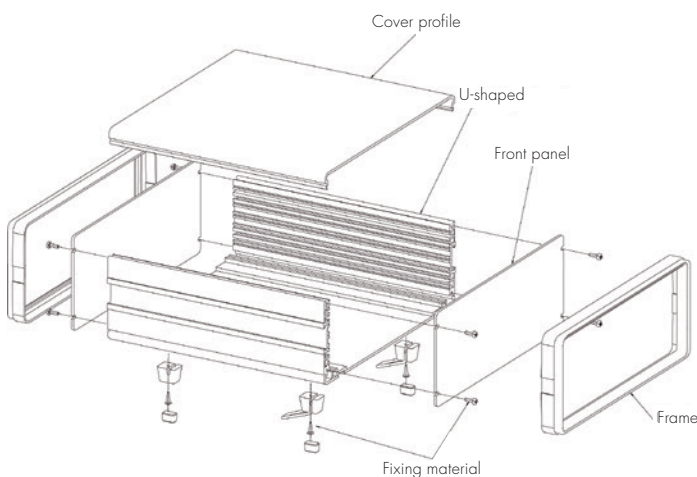

DESIGN AND COMPACT CASES

GUARDBOX 33

Accessories

CARRYING HANDLES

- Powder-coated zinc die-cast
- Handle piece: Black polyurethane, UL94 V-0
- Handle can be attached to any position on the side of the groove
- Handle is 90° detent (carrying position has a slight detent)
- According to the enclosure in two widths available

Scope of delivery:

- 1 pre-assembled handle with assembly material

Color	Part-No. 212 mm (8.34") for enclosure 2 and 3	Part-No. 188 mm (7.40") for enclosure 4
Light gray	33-635	33-636
Black	33-645	33-646
Stone gray	33-630	33-631

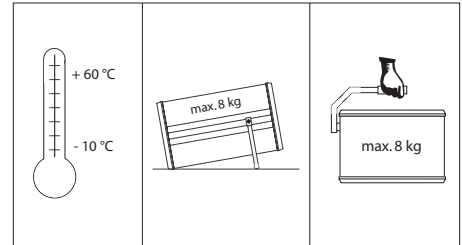

Carrying capacity depends on distribution of load and handling. Decreases with dynamic stress.

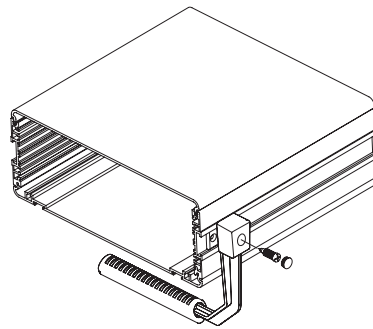
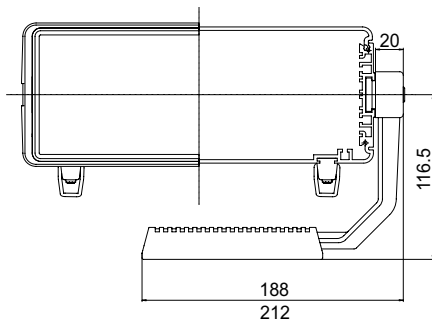

BRACKET FOR MOUNTING IN CONSOLES

- Mounting brackets of 3 mm (0.11") aluminum sheet
- Angles are pushed to the side of the grooves and with 2 grub screws each M4 x 6 mm positioned
- With mounting brackets as a built-in enclosure in control panels etc. usable

Scope of delivery:

- 2 mounting brackets
- 4 screws M4 x 6 mm

Description	Part-No.
For enclosure 0 - 4	33-650

Enclosure	A		B		C	
	mm	inch	mm	inch	mm	inch
0	65	2.55	152	5.98	178.5	7.02
1	81.5	3.2	152	5.98	178.5	7.02
2	65	2.55	253	9.96	279.5	11
3	99	3.89	254	10	280.5	11.02
4	121	4.76	207	8.14	233.5	9.19

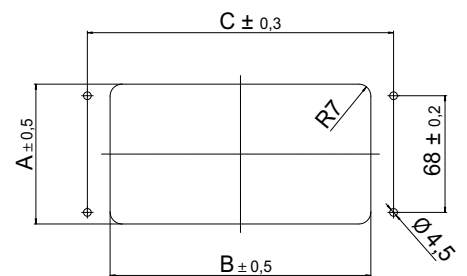
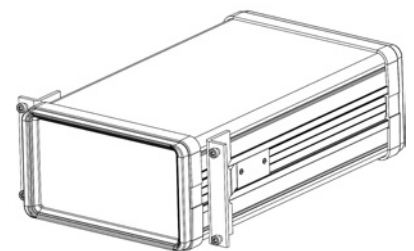

DESIGN AND COMPACT CASES

GUARDBOX 33

HANDLE CHANNEL AND FOOT SLOT NUT

- Sliding blocks expand the fastening options
- Handle channel stones are pushed into the side groove of the enclosure
- Foot slot nut are used instead of the feet

Scope of delivery:

- Sliding blocks incl. screws

Enclosure	Description	Scope of delivery	Part-No.
0 - 4	Handle groove	1 piece	33-665
0 - 5	Foot groove	4 pieces	33-666

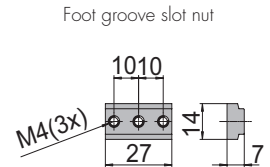
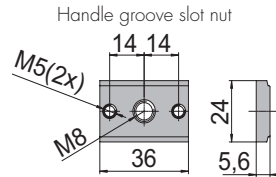

SINGLE EUROCARDS MOUNTING SETS

- For the installation of Eurocards 100 x 160 mm (3.93 x 6.29") with connectors according to IEC60603-2
- Card carrier 1 mm (0.03") galvanized sheet steel for the installation of the enclosure 0 - 4
- Other use: Vertical mounting of cards in enclosure size 4 (fastening lugs have to be removed)

Scope of delivery:

- 1 card carrier
- Assembly material in set
- A mounting plate has to be ordered if cards are to be mounted horizontally in enclosure sizes 2, 3 and 4

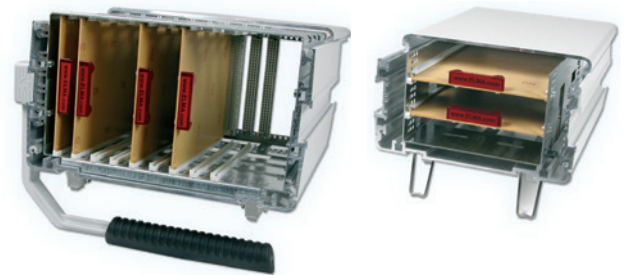

Enclosure	Mounting of cards	Part-No.
1, 3 and 4	horizontal	33-205
0 and 2	horizontal	33-204
4	vertical	33-210

Other versions on request

Card mounting horizontally:

Enclosure	A		B		C		D	
	mm	inch	mm	inch	mm	inch	mm	inch
0 and 2	49.76	1.95	7 x 5.08	0.2	7 x 5.08	0.2	41.76	1.64
1, 3 and 4	65	2.55	10 x 5.08	0.2	10 x 5.08	0.2	57	2.24

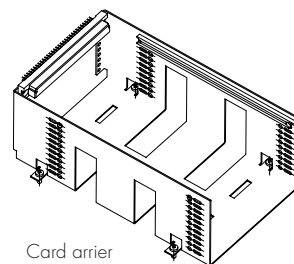
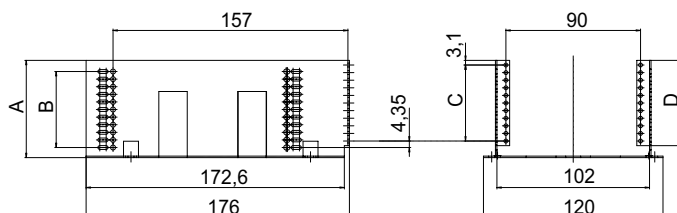
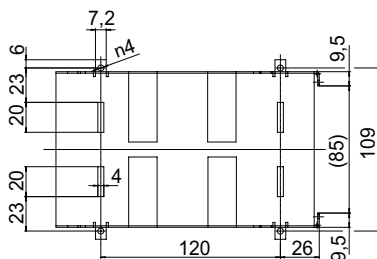

Card carrier

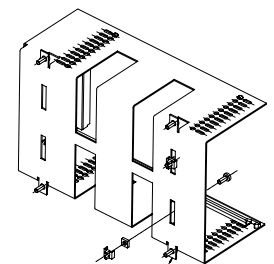

Fastening lugs (cards mounted vertically)

Note:
For vertical mounting of cards in enclosure size 4, fastening lugs have to be removed

DESIGN AND COMPACT CASES

GUARDBOX 33

Accessories

SINGLE EUROCARDS MOUNTING SETS

Card mounting vertically | enclosure 4

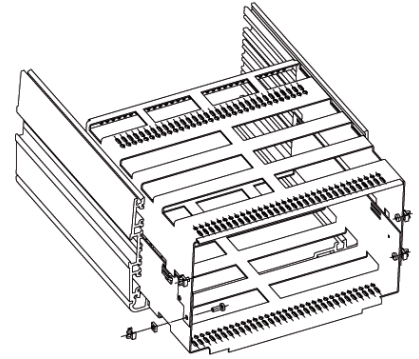
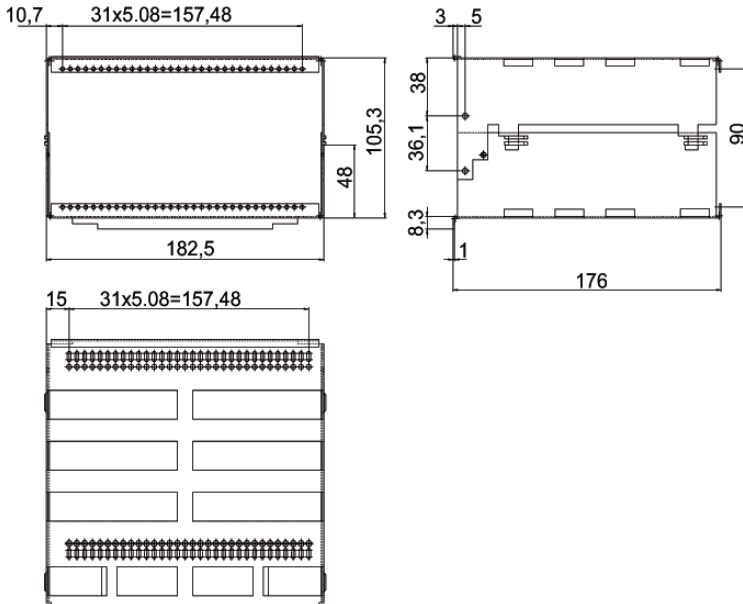

CARD GUIDES

- In each pair, one card guide is fitted with a card locking mechanism
- Light gray UL94 V-0

Scope of delivery:

- Card guides in pairs

Enclosure size	Part-No.
160 mm (6.29")	61-034

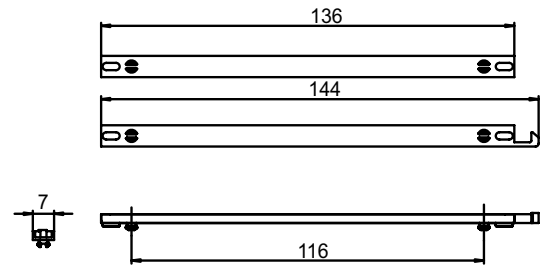

CARD HANDLES

- Card handles made of transparent plastic for better access and labeling of the plug-in plates

Scope of delivery:

- 1 card handle
- Two screws per card handle M2.5 x 5 are needed (ordered separately)

Description	Color	Part-No.
Card handle	clear	1091-51
	red	1091-54
Cylindrical screw M2.5 x 5		5571-05
Cylinder head screw torx T8 (M2.5 x 5)		5470-07

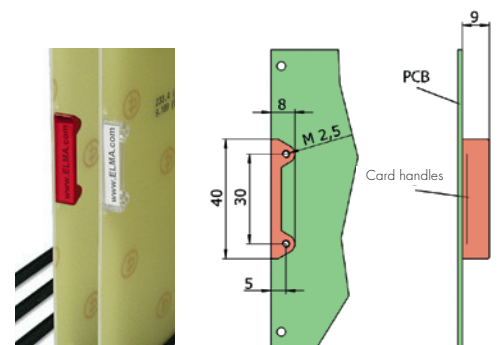

DESIGN AND COMPACT CASES

GUARDBOX 33

MOUNTING SET FOR PLUG-IN UNITS (SINGLE EUROCARDS)

- Galvanised sheet steel plug-in sub-unit allowing 3 U plug-in units (Eurocards 100 x 160 mm with IEC60603-2 connectors and flat or extruded front panels) to be mounted horizontally in the Guardbox 33
- The usable height is oder Installation height? 12 HP
- Enclosure front panel 129.2 x 61 mm (5.08 x 2.40") is made from 2.5 mm thick anodised sheet aluminum

Scope of delivery:

- 1 plug-in card carrier sub-unit
- 1 front panel with opening for enclosure 1
- Assembly material for sub-unit

Mounting set for plug-in units (single Eurocards):

Description	Part-No.
Complete sub-unit for enclosure 1	33-207

Sub-unit for enclosure 3 and 4:

- The sub-unit can also be used for enclosure 3 and 4.
(front panel can be manufactured with openings to your own specifications)
- The corresponding mounting plate must be ordered to install the plug-in block

Description	Part-No.
Plug-in block	33-206
Assembly material for plug-in unit	33-616

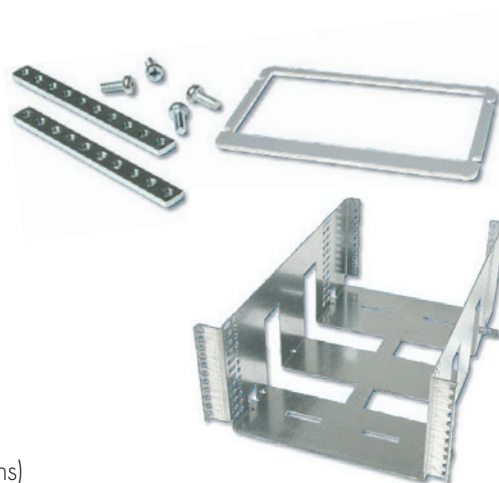

CARD STOP SET

- Card stoppers are used for card fixation of double Eurocards, if these are installed directly in enclosures 2, 3 and 5

Scope of delivery:

- 4 card stopper made of aluminum profile
- 4 hexagon socket set screws
- 1 hexagon socket key

Enclosure	Part-No.
0 - 5	33-618

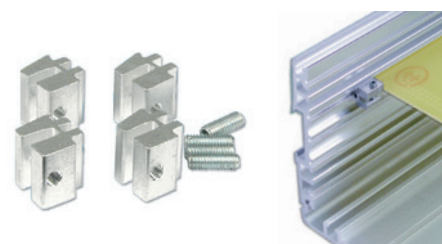

DESIGN AND COMPACT CASES

GUARDBOX 33

Accessories

MOUNTING PANELS

- Mounting plates of 2 mm (0.07") thick sheet aluminum
- Dimensions correspond to the respective enclosure size
- Position of the slots allows various mounting arrangements and good air circulation
- The mounting plate is screwed to the grooved enclosure profile



Scope of delivery:

- 1 mounting plate, aluminum raw
- Assembly material included in the basic set

Enclosure	Part-No. 180 mm 7.08 inch	Part-No. 240 mm 9.44 inch	Part-No. 300 mm 11.81 inch
0 and 1	33-313	33-314	
2, 3 and 5		33-324	33-325
4		33-344	

EARTHING TERMINAL

Front panel screws:

- Earthing terminal enables EN / VDE / SEV-compliant earthing

Scope of delivery:

- 1 earthing nut M3.5
- 1 threaded bolt M3.5
- 1 clamping yoke
- 2 serrated washers
- 1 nut M3.5
- 1 earthing symbol

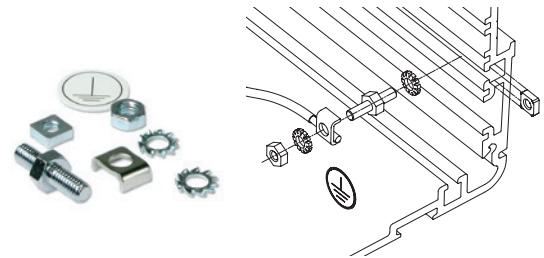

Enclosure	Description	Part-No.
0 - 5	Earthing terminal	33-619

DESIGN AND COMPACT CASES

GUARDBOX 33

Norms

IP PROTECTION CLASSES



- Protection against contact and foreign bodies according to IEC60529
- Protection against water according to IEC60529



Evaluation of classification:

- The test results according to the standard do not entirely exclude leaks and an individual test is therefore recommended in critical cases (with the actual equipment layout)
- The protection class for cabinets and enclosures is specified by IP (International protection) and two indices

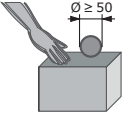
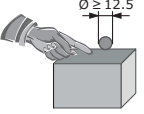
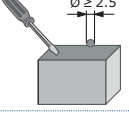
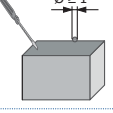
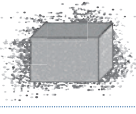
Example IP55

- └ Protection against penetration by water jets from all directions
- └ Complete protection against contact with internal parts and against dust deposition

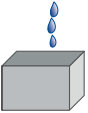
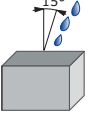
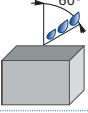
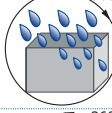
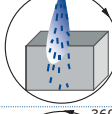
First index	Contact protection	Foreign body protection
0 	No special protection	
1 	Against large areas of body	Large foreign bodies Ø ≥ 50 mm (1.97")
2 	Against fingers or objects of similar size	Medium-sized foreign bodies Ø ≥ 12.5 mm (0.49")
3 	Against tools, wires, etc. with a thickness of > 2.5mm	Small foreign bodies Ø ≥ 2.5 mm (0.10")
4 	Against tools, wires, etc. with thickness > 1mm	Grain-like foreign bodies Ø ≥ 1.0 mm (0.04")
5 	Complete protection	Dust-protected: Dust deposits are permitted, but their volume must not affect the function of the unit
6 	Complete protection	Dust-proof

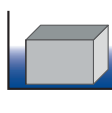
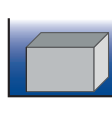
Second index	Water protection
0 	No special protection
1 	Against water dripping vertically
2 	Against water dripping at an angle (up to 15° from the vertical)
3 	Against spray water (any direction up to 60° from the vertical)
4 	Against spray water from all directions
5 	Against water jets from a nozzle in all directions
6 	Against inundation
7 	Against immersion
8 	Against submersion

DESIGN AND COMPACT CASES

GUARDBOX 33

Tests

ENVIRONMENTAL AND MECHANICAL TESTS

The Guardbox 33 was tested after the following tests:

- Vibration EN50155 (EN61373)
- Shock EN60068-2-27
- IP protection IEC60529
- Salt spray test DIN50021

Detail information to environmental and mechanical tests:

Tests	Information
Vibration EN50155 (EN61373, category 1, class B)	Eff. acceleration: 7.9 m / s ² oder s ² Duration: 5 h / axis oder shaft? Frequency: 5 to 150 Hz Axis of stimulation: X, Y, Z
Shock EN60068-2-27	Shockform: Halfsinus Acceleration: 150 m / s ² Duration: 11 ms Number of shocks: 3 / axle Total shocks: 18
IP protection IEC60529	IP65: Guardbox 33 with IP65 sealing set IP54: Guardbox 33 with IP54 / EMC sealing set
Salt spray test DIN50021	Salt concentration: 5 g / l Duration: 96 h Temperature: +35 °C