

MSTBVA 2,5/13-G - PCB header



1755613

<https://www.phoenixcontact.com/us/products/1755613>

Please be informed that the data shown in this PDF document is generated from our Online Catalog. Please find the complete data in the user documentation. Our General Terms of Use for Downloads are valid.

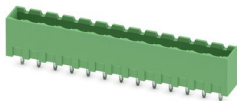

PCB headers, nominal cross section: 2.5 mm², color: green, nominal current: 12 A, rated voltage (III/2): 320 V, contact surface: Tin, type of contact: Pin, number of potentials: 13, number of rows: 1, number of positions: 13, number of connections: 13, product range: MSTBVA 2,5/...-G, pitch: 5 mm, mounting: Wave soldering, pin layout: Linear pinning, solder pin [P]: 3.9 mm, number of solder pins per potential: 1, plug-in system: COMBICON MSTB 2,5, Pin connector pattern alignment: Standard, locking: without, mounting: without, type of packaging: packed in cardboard

Your advantages

- Maximum flexibility when it comes to device design – one header for connectors with different connection technologies
- Well-known mounting principle allows worldwide use
- Vertical connection enables multi-row arrangement on the PCB
- Closed contour for optimum stability of the plug-in connection
- Easy PCB replacement thanks to plug-in modules

Commercial Data

Item number	1755613
Packing unit	1 pc
Minimum order quantity	50 pc
Sales Key	AA03
Product Key	AACSLE
Catalog Page	Page 315 (C-1-2013)
GTIN	4017918029197
Weight per Piece (including packing)	5.72 g
Weight per Piece (excluding packing)	4.91 g
Customs tariff number	85366930
Country of origin	DE

MSTBVA 2,5/13-G - PCB header



1755613

<https://www.phoenixcontact.com/us/products/1755613>

Technical Data

Product properties

Type	Standard
Product line	COMBICON Connectors M
Product type	PCB headers
Product family	MSTBVA 2,5/..-G
Number of positions	13
Pitch	5 mm
Number of connections	13
Number of rows	1
Mounting flange	without
Number of potentials	13
Pin layout	Linear pinning
Solder pins per potential	1

Electrical properties

Nominal current I_N	12 A
Nominal voltage U_N	320 V
Degree of pollution	3
Contact resistance	2.5 mΩ
Rated voltage (III/3)	250 V
Rated surge voltage (III/3)	4 kV
Rated voltage (III/2)	320 V
Rated surge voltage (III/2)	4 kV
Rated voltage (II/2)	400 V
Rated surge voltage (II/2)	4 kV

Mounting

Mounting type	Wave soldering
Pin layout	Linear pinning

Material specifications

Material data - contact

Note	WEEE/RoHS-compliant, free of whiskers according to IEC 60068-2-82/JEDEC JESD 201
Contact material	Cu alloy
Surface characteristics	Tin-plated
Metal surface contact area (top layer)	Tin (3 - 5 μm Sn)
Metal surface contact area (middle layer)	Nickel (1.3 - 3 μm Ni)
Metal surface soldering area (top layer)	Tin (3 - 5 μm Sn)
Metal surface soldering area (middle layer)	Nickel (1.3 - 3 μm Ni)

Material data - housing

MSTBVA 2,5/13-G - PCB header

1755613

<https://www.phoenixcontact.com/us/products/1755613>

Color (Housing)	green (6021)
Insulating material	PBT
Insulating material group	IIIa
CTI according to IEC 60112	225
Flammability rating according to UL 94	V0

Material data – actuating element

Color ()	()
----------	----

Notes

Notes on operation	In accordance with IEC 61984, COMBICON connectors have no switching power (COC). During designated use, they must not be plugged in or disconnected when carrying voltage or under load.
--------------------	--

Dimensions

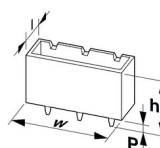
Dimensional drawing	
Pitch	5 mm
Width [w]	67 mm
Height [h]	15.9 mm
Length [l]	8.6 mm
Installed height	12 mm
Solder pin length [P]	3.9 mm

Mechanical tests

Test for conductor damage and slackening

Specification	IEC 60999-1:1999-11
Result	Test passed

Pull-out test

Specification	IEC 60999-1:1999-11
Conductor cross section/conductor type/tractive force setpoint/actual value	0.14 mm ² / solid / > 10 N
	0.14 mm ² / flexible / > 10 N
	2.5 mm ² / solid / > 50 N
	2.5 mm ² / flexible / > 50 N

Insertion and withdrawal forces

Result	Test passed
No. of cycles	25
Insertion strength per pos. approx.	8 N
Withdraw strength per pos. approx.	6 N

MSTBVA 2,5/13-G - PCB header



1755613

<https://www.phoenixcontact.com/us/products/1755613>

Torque test

Specification	IEC 60999-1:1999-11
---------------	---------------------

Contact holder in insert

Specification	IEC 60512-15-1:2008-05
Contact holder in insert Requirements >20 N	Test passed

Resistance of inscriptions

Specification	IEC 60068-2-70:1995-12
Result	Test passed

Polarization and coding

Specification	IEC 60512-13-5:2006-02
Result	Test passed

Visual inspection

Specification	IEC 60512-1-1:2002-02
Result	Test passed

Dimension check

Specification	IEC 60512-1-2:2002-02
Result	Test passed

Electrical tests

Thermal test | Test group C

Specification	IEC 60512-5-1:2002-02
Tested number of positions	24

Insulation resistance

Specification	IEC 60512-3-1:2002-02
Insulation resistance, neighboring positions	> 5 MΩ

Air clearances and creepage distances |

Specification	IEC 60664-1:2007-04
Insulating material group	IIIa
Comparative tracking index (IEC 60112)	CTI 225
Rated insulation voltage (III/3)	250 V
Rated surge voltage (III/3)	4 kV
minimum clearance value - non-homogenous field (III/3)	3 mm
minimum creepage distance (III/3)	4 mm
Rated insulation voltage (III/2)	320 V
Rated surge voltage (III/2)	4 kV
minimum clearance value - non-homogenous field (III/2)	3 mm
minimum creepage distance (III/2)	3.2 mm
Rated insulation voltage (II/2)	400 V
Rated surge voltage (II/2)	4 kV

MSTBVA 2,5/13-G - PCB header



1755613

<https://www.phoenixcontact.com/us/products/1755613>

minimum clearance value - non-homogenous field (II/2)	3 mm
minimum creepage distance (II/2)	4 mm

Environmental and real-life conditions

Vibration test

Specification	IEC 60068-2-6:2007-12
Frequency	10 - 150 - 10 Hz
Sweep speed	1 octave/min
Amplitude	0.35 mm (10 Hz ... 60.1 Hz)
Sweep speed	5g (60.1 Hz ... 150 Hz)
Test duration per axis	2.5 h

Durability test

Specification	IEC 60512-9-1:2010-03
Impulse withstand voltage at sea level	4.8 kV
Contact resistance R ₁	2.5 mΩ
Contact resistance R ₂	2.5 mΩ
Insertion/withdrawal cycles	25
Insulation resistance, neighboring positions	> 5 MΩ

Climatic test

Specification	ISO 6988:1985-02
Corrosive stress	0.2 dm ³ SO ₂ on 300 dm ³ /40 °C/1 cycle
Thermal stress	100 °C/168 h
Power-frequency withstand voltage	2.21 kV

Ambient conditions

Ambient temperature (operation)	-40 °C ... 100 °C (dependent on the derating curve)
Ambient temperature (storage/transport)	-40 °C ... 70 °C
Relative humidity (storage/transport)	30 % ... 70 %
Ambient temperature (assembly)	-5 °C ... 100 °C

Packaging specifications

Type of packaging	packed in cardboard
-------------------	---------------------

Drawings

Diagram

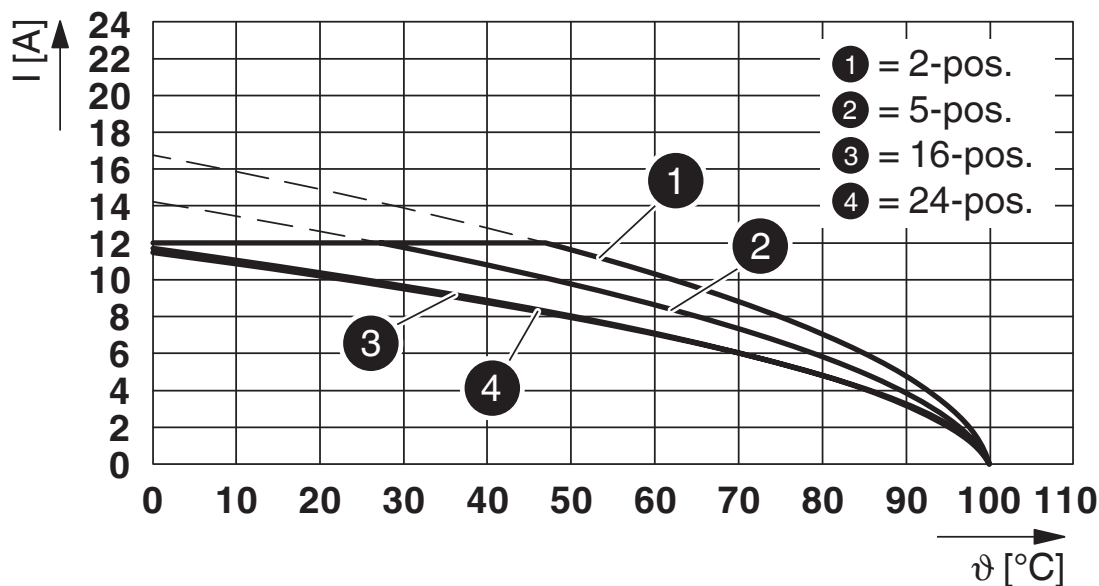

Type: MVSTBR 2,5/...-ST with MSTBVA 2,5/...-G

Diagram

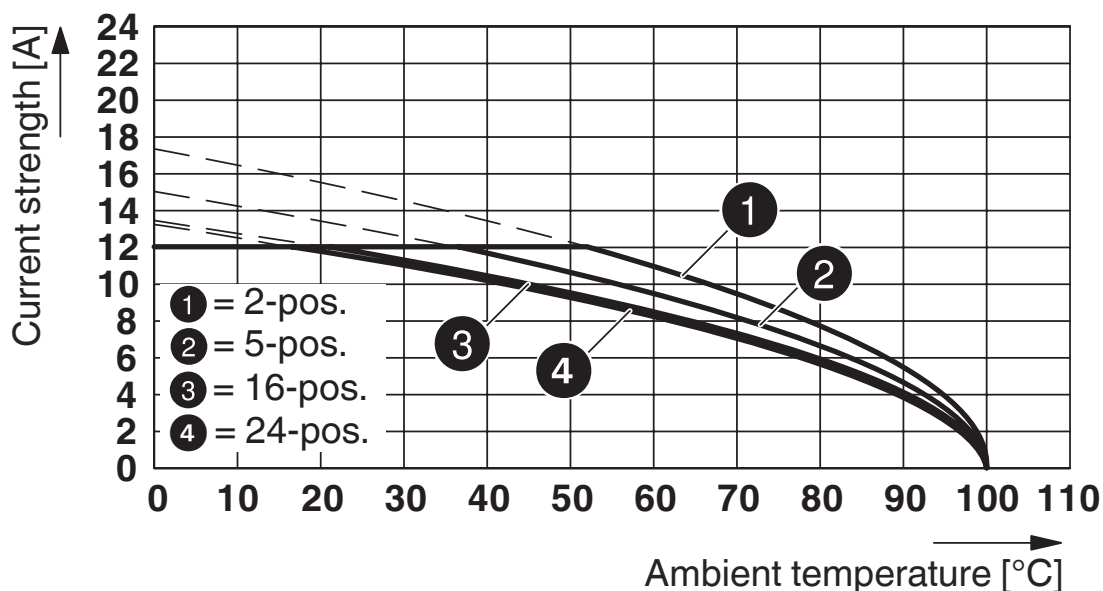

Type: MSTB 2,5/...-ST with MSTBVA 2,5/...-G

1755613

<https://www.phoenixcontact.com/us/products/1755613>

Diagram

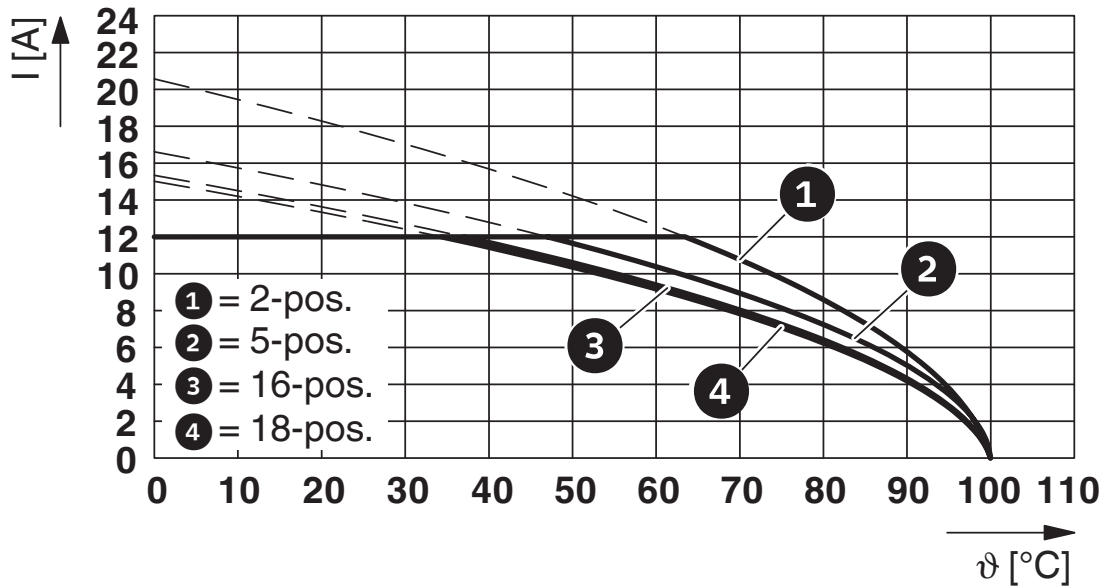

Type: FKCN 2,5/...-ST with MSTBVA 2,5/...-G

Diagram

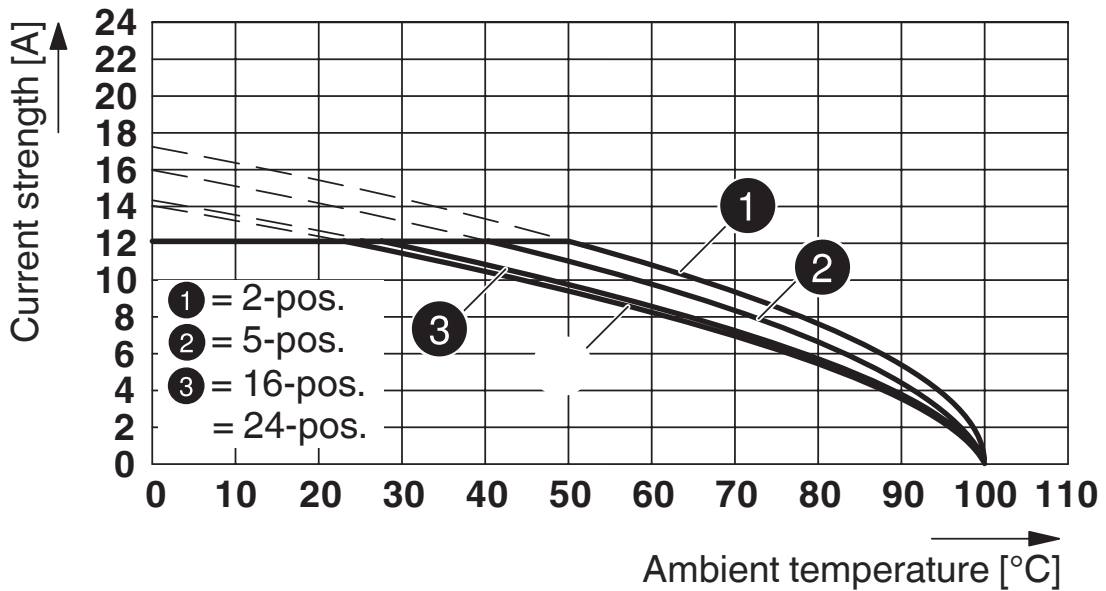

Type: MSTBP 2,5/...-ST with MSTBVA 2,5/...-G

MSTBVA 2,5/13-G - PCB header

1755613

<https://www.phoenixcontact.com/us/products/1755613>

Drilling plan/solder pad geometry

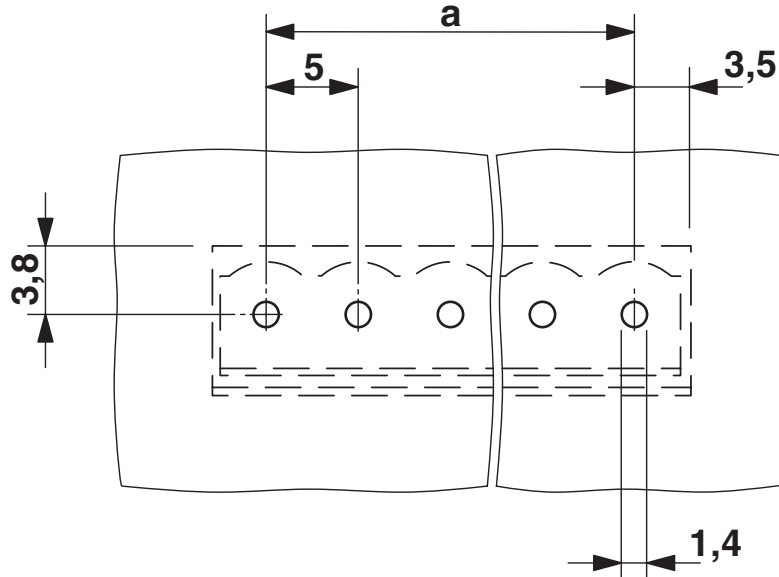

Diagram

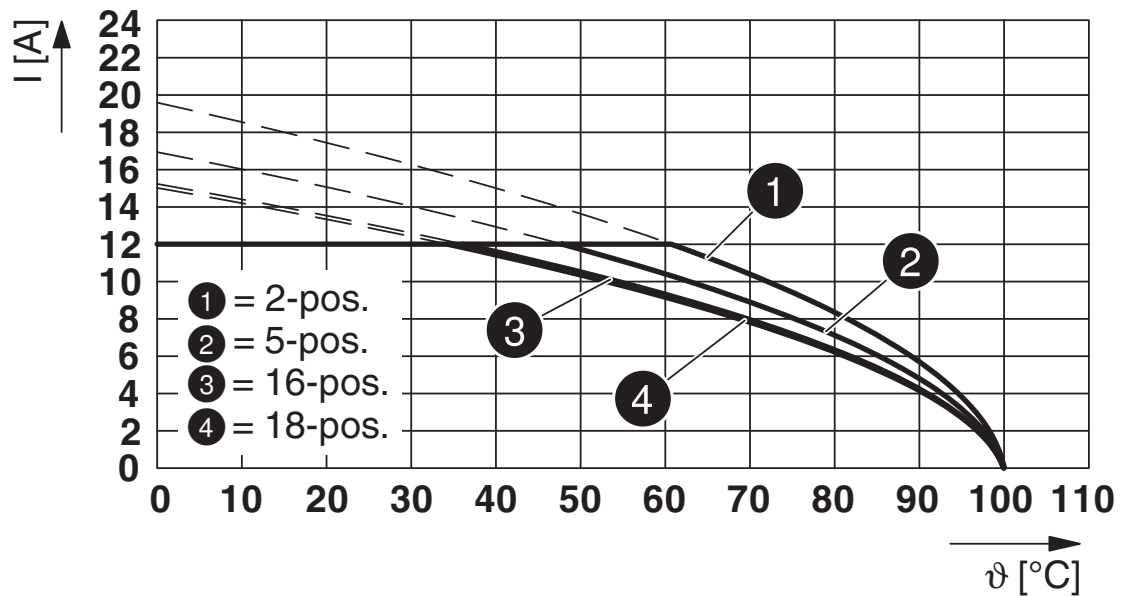

Type: FKCV(W/R) 2,5/...-ST with MSTBVA 2,5/...-G

1755613

<https://www.phoenixcontact.com/us/products/1755613>

Diagram

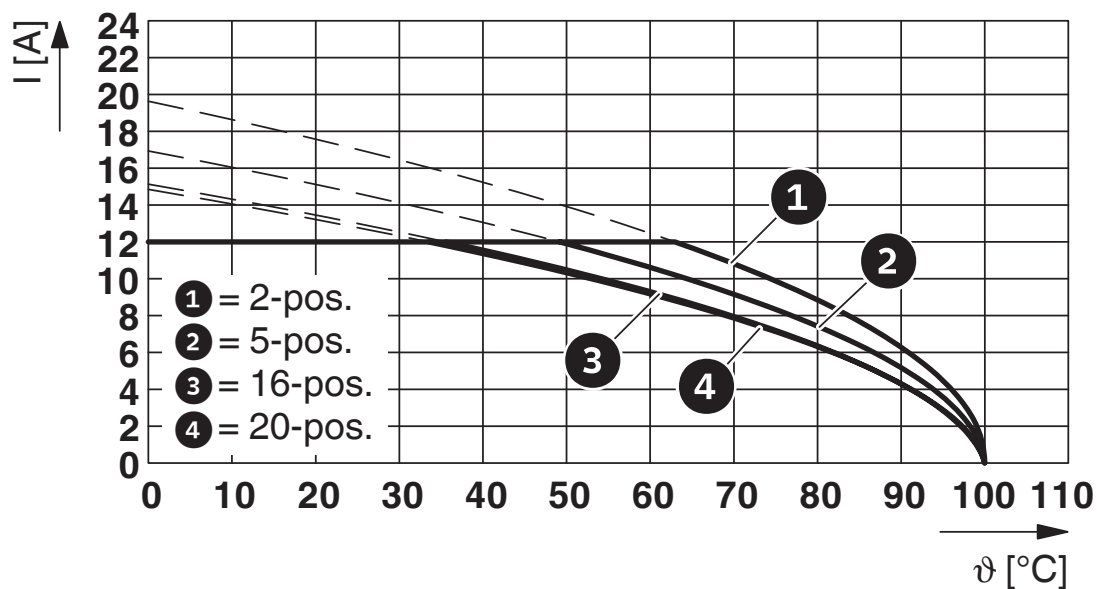

Type: FKCT 2,5/...-ST with MSTBVA 2,5/...-G

Diagram

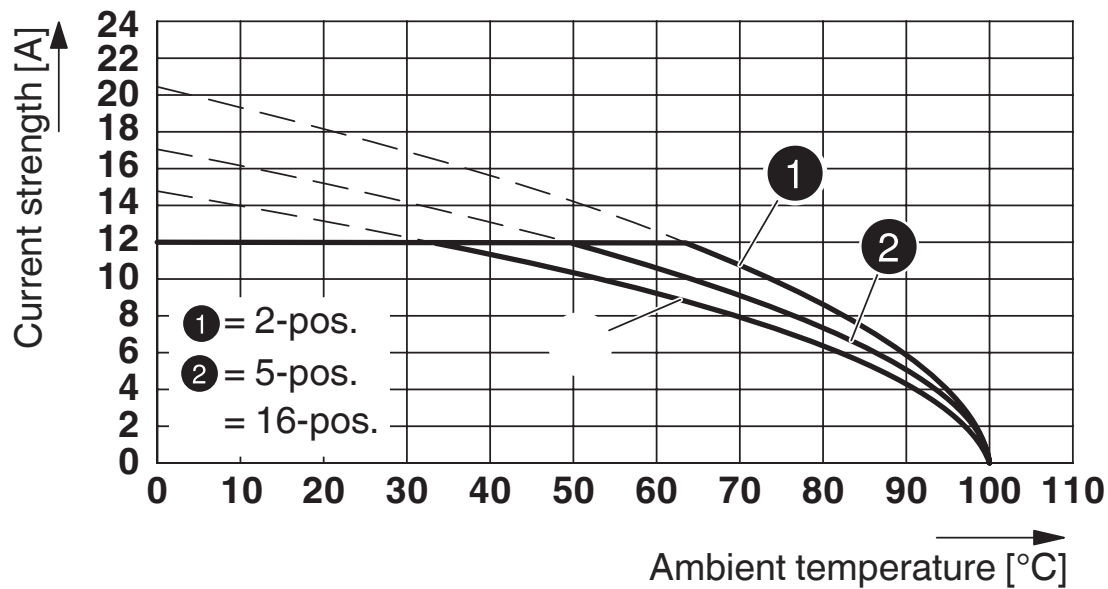

Type: MSTBT 2,5/...-ST with MSTBVA 2,5/...-G

MSTBVA 2,5/13-G - PCB header



1755613

<https://www.phoenixcontact.com/us/products/1755613>

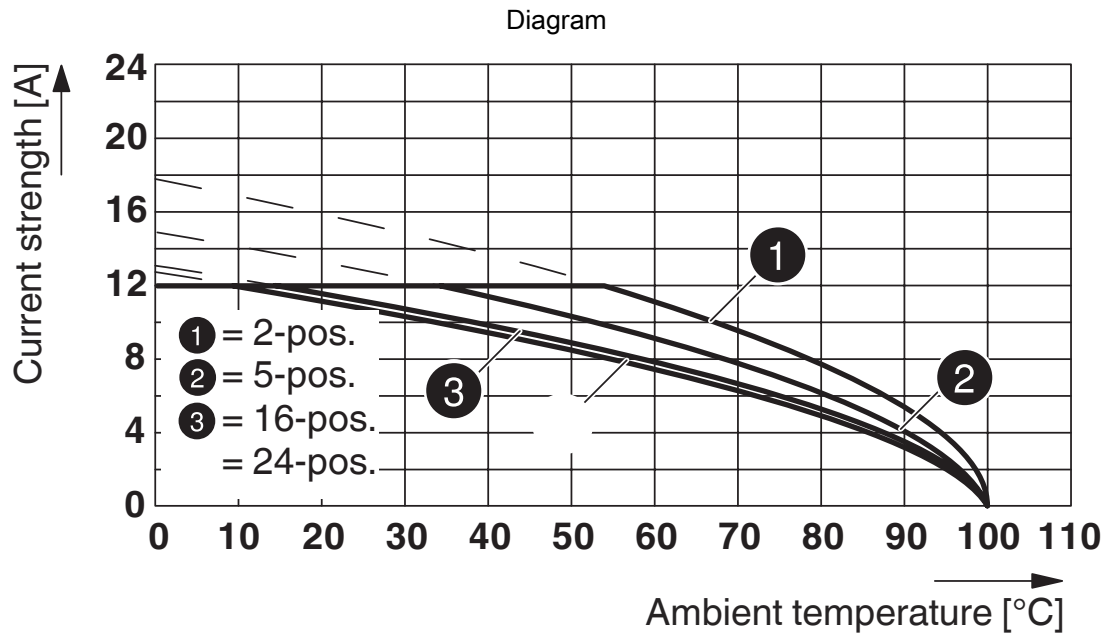

Type: SMSTB 2,5/...-ST with MSTBVA 2,5/...-G

MSTBVA 2,5/13-G - PCB header



1755613

<https://www.phoenixcontact.com/us/products/1755613>

Approvals

 CSA Approval ID: 13631				
	Nominal Voltage U_N	Nominal Current I_N	Cross Section AWG	Cross Section mm^2
Use group B	300 V	12 A	-	-
Use group D	300 V	10 A	-	-

 IECEE CB Scheme Approval ID: DE1-60988-B1B2				
	Nominal Voltage U_N	Nominal Current I_N	Cross Section AWG	Cross Section mm^2
	250 V	12 A	-	-

 EAC Approval ID: B.01687				
--	--	--	--	--

 cULus Recognized Approval ID: E60425-19931011				
	Nominal Voltage U_N	Nominal Current I_N	Cross Section AWG	Cross Section mm^2
Use group B	300 V	12 A	-	-
Use group D	300 V	10 A	-	-

 VDE Zeichengenehmigung Approval ID: 40050648				
	Nominal Voltage U_N	Nominal Current I_N	Cross Section AWG	Cross Section mm^2
	250 V	12 A	-	-

MSTBVA 2,5/13-G - PCB header



1755613

<https://www.phoenixcontact.com/us/products/1755613>

Classifications

ECLASS

ECLASS-11.0	27460201
ECLASS-12.0	27460201
ECLASS-13.0	27460201

ETIM

ETIM 8.0	EC002637
----------	----------

UNSPSC

UNSPSC 21.0	39121400
-------------	----------

MSTBVA 2,5/13-G - PCB header



1755613

<https://www.phoenixcontact.com/us/products/1755613>

Environmental Product Compliance

China RoHS	Environmentally friendly use period: unlimited = EFUP-e
	No hazardous substances above threshold values

MSTBVA 2,5/13-G - PCB header

1755613

<https://www.phoenixcontact.com/us/products/1755613>

Accessories

CR-MSTB - Coding section

1734401

<https://www.phoenixcontact.com/us/products/1734401>

Coding section, inserted into the recess in the header or the inverted plug, red insulating material



SK 5/3,8:FORTL.ZAHLEN - Marker card

0804183

<https://www.phoenixcontact.com/us/products/0804183>

Marker card, white, labeled, horizontal: consecutive numbers 1 ... 10, 11 ... 20, etc. up to 91 ... (99)100, mounting type: adhesive, for terminal block width: 5 mm, lettering field size: 5 x 3.8 mm



MSTBVA 2,5/13-G - PCB header

1755613

<https://www.phoenixcontact.com/us/products/1755613>



MSTB-BL - Accessories

1755477

<https://www.phoenixcontact.com/us/products/1755477>



Keying cap, for forming sections, plugs onto header pin, green insulating material

QC 1,5/13-ST - PCB connector

1718070

<https://www.phoenixcontact.com/us/products/1718070>



PCB connector, nominal cross section: 1.5 mm², color: green, nominal current: 12 A, rated voltage (III/2): 630 V, contact surface: Tin, type of contact: Socket, number of potentials: 13, number of rows: 1, number of positions: 13, number of connections: 13, product range: QC 1,5/..-ST, pitch: 5 mm, connection method: Displacement connection, conductor/PCB connection direction: 0 °, locking clip: - Locking clip, plug-in system: COMBICON MSTB 2,5, locking: without, mounting: without, type of packaging: packed in cardboard

MSTBVA 2,5/13-G - PCB header

1755613

<https://www.phoenixcontact.com/us/products/1755613>



FKCN 2,5/13-ST - PCB connector

1732849

<https://www.phoenixcontact.com/us/products/1732849>

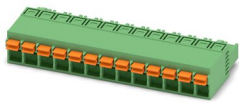

PCB connector, nominal cross section: 2.5 mm², color: green, nominal current: 12 A, rated voltage (III/2): 320 V, contact surface: Tin, type of contact: Socket, number of potentials: 13, number of rows: 1, number of positions: 13, number of connections: 13, product range: FKCN 2,5/..-ST, pitch: 5 mm, connection method: Push-in spring connection, conductor/PCB connection direction: 0 °, locking clip: - Locking clip, plug-in system: COMBICON MSTB 2,5, locking: without, mounting: without, type of packaging: packed in cardboard

MSTB 2,5/13-ST - PCB connector

1754669

<https://www.phoenixcontact.com/us/products/1754669>

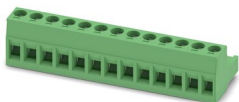

PCB connector, nominal cross section: 2.5 mm², color: green, nominal current: 12 A, rated voltage (III/2): 320 V, contact surface: Tin, type of contact: Socket, number of potentials: 13, number of rows: 1, number of positions: 13, number of connections: 13, product range: MSTB 2,5/..-ST, pitch: 5 mm, connection method: Screw connection with tension sleeve, screw head form: L Slotted, conductor/PCB connection direction: 0 °, locking clip: - Locking clip, plug-in system: COMBICON MSTB 2,5, locking: without, mounting: without, type of packaging: packed in cardboard

MSTBVA 2,5/13-G - PCB header

1755613

<https://www.phoenixcontact.com/us/products/1755613>



MSTB 2,5/13-STZ - PCB connector

1759363

<https://www.phoenixcontact.com/us/products/1759363>



PCB connector, nominal cross section: 2.5 mm², color: green, nominal current: 12 A, rated voltage (III/2): 320 V, contact surface: Tin, type of contact: Socket, number of potentials: 13, number of rows: 1, number of positions: 13, number of connections: 13, product range: MSTB 2,5/..-STZ, pitch: 5 mm, connection method: Screw connection with tension sleeve, screw head form: L Slotted, conductor/PCB connection direction: 0 °, locking clip: - Locking clip, plug-in system: COMBICON MSTB 2,5, locking: without, mounting: without, type of packaging: packed in cardboard

MSTBP 2,5/13-ST - PCB connector

1765881

<https://www.phoenixcontact.com/us/products/1765881>



PCB connector, nominal cross section: 2.5 mm², color: green, nominal current: 12 A, rated voltage (III/2): 320 V, contact surface: Tin, type of contact: Socket, number of potentials: 13, number of rows: 1, number of positions: 13, number of connections: 13, product range: MSTBP 2,5/..-ST, pitch: 5 mm, connection method: Screw connection with tension sleeve, screw head form: L Slotted, conductor/PCB connection direction: 0 °, locking clip: - Locking clip, plug-in system: COMBICON MSTB 2,5, locking: without, mounting: without, type of packaging: packed in cardboard

MSTBVA 2,5/13-G - PCB header

1755613

<https://www.phoenixcontact.com/us/products/1755613>



SMSTB 2,5/13-ST - PCB connector

1768862

<https://www.phoenixcontact.com/us/products/1768862>



PCB connector, nominal cross section: 2.5 mm², color: green, nominal current: 12 A, rated voltage (III/2): 320 V, contact surface: Tin, type of contact: Socket, number of potentials: 13, number of rows: 1, number of positions: 13, number of connections: 13, product range: SMSTB 2,5/..-ST, pitch: 5 mm, connection method: Screw connection with tension sleeve, screw head form: L Slotted, conductor/PCB connection direction: -45 °, locking clip: - Locking clip, plug-in system: COMBICON MSTB 2,5, locking: without, mounting: without, type of packaging: packed in cardboard

FRONT-MSTB 2,5/13-ST - PCB connector

1779521

<https://www.phoenixcontact.com/us/products/1779521>



PCB connector, nominal cross section: 2.5 mm², color: green, nominal current: 12 A, rated voltage (III/2): 320 V, contact surface: Tin, type of contact: Socket, number of potentials: 13, number of rows: 1, number of positions: 13, number of connections: 13, product range: FRONT-MSTB 2,5/..-ST, pitch: 5 mm, connection method: Front screw connection, screw head form: L Slotted, conductor/PCB connection direction: 0 °, locking clip: - Locking clip, plug-in system: COMBICON MSTB 2,5, locking: without, mounting: without, type of packaging: packed in cardboard

MSTBVA 2,5/13-G - PCB header

1755613

<https://www.phoenixcontact.com/us/products/1755613>



MSTBT 2,5/13-ST - PCB connector

1779945

<https://www.phoenixcontact.com/us/products/1779945>



PCB connector, nominal cross section: 2.5 mm², color: green, nominal current: 12 A, rated voltage (III/2): 320 V, contact surface: Tin, type of contact: Socket, number of potentials: 13, number of rows: 1, number of positions: 13, number of connections: 13, product range: MSTBT 2,5/...-ST, pitch: 5 mm, connection method: Screw connection with tension sleeve, screw head form: L Slotted, conductor/PCB connection direction: 0 °, locking clip: - Locking clip, plug-in system: COMBICON MSTB 2,5, locking: without, mounting: without, type of packaging: packed in cardboard

MVSTBR 2,5/13-ST - PCB connector

1792126

<https://www.phoenixcontact.com/us/products/1792126>

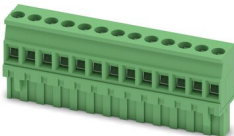

PCB connector, nominal cross section: 2.5 mm², color: green, nominal current: 12 A, rated voltage (III/2): 320 V, contact surface: Tin, type of contact: Socket, number of potentials: 13, number of rows: 1, number of positions: 13, number of connections: 13, product range: MVSTBR 2,5/...-ST, pitch: 5 mm, connection method: Screw connection with tension sleeve, screw head form: L Slotted, conductor/PCB connection direction: 90 °, locking clip: - Locking clip, plug-in system: COMBICON MSTB 2,5, locking: without, mounting: without, type of packaging: packed in cardboard

MSTBVA 2,5/13-G - PCB header

1755613

<https://www.phoenixcontact.com/us/products/1755613>



MVSTBW 2,5/13-ST - PCB connector

1792634

<https://www.phoenixcontact.com/us/products/1792634>

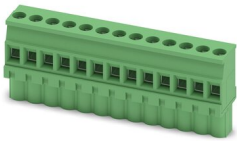

PCB connector, nominal cross section: 2.5 mm², color: green, nominal current: 12 A, rated voltage (III/2): 320 V, contact surface: Tin, type of contact: Socket, number of potentials: 13, number of rows: 1, number of positions: 13, number of connections: 13, product range: MVSTBW 2,5/...-ST, pitch: 5 mm, connection method: Screw connection with tension sleeve, screw head form: L Slotted, conductor/PCB connection direction: -90 °, locking clip: - Locking clip, plug-in system: COMBICON MSTB 2,5, locking: without, mounting: without, type of packaging: packed in cardboard

FKCT 2,5/13-ST - PCB connector

1909320

<https://www.phoenixcontact.com/us/products/1909320>

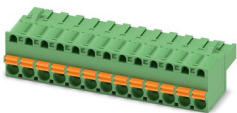

PCB connector, nominal cross section: 2.5 mm², color: green, nominal current: 12 A, rated voltage (III/2): 320 V, contact surface: Tin, type of contact: Socket, number of potentials: 13, number of rows: 1, number of positions: 13, number of connections: 13, product range: FKCT 2,5/...-ST, pitch: 5 mm, connection method: Push-in spring connection, conductor/PCB connection direction: 0 °, locking clip: - Locking clip, plug-in system: COMBICON MSTB 2,5, locking: without, mounting: without, type of packaging: packed in cardboard

MSTBVA 2,5/13-G - PCB header

1755613

<https://www.phoenixcontact.com/us/products/1755613>



FKCVR 2,5/13-ST - PCB connector

1909825

<https://www.phoenixcontact.com/us/products/1909825>

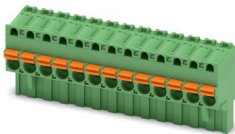

PCB connector, nominal cross section: 2.5 mm², color: green, nominal current: 12 A, rated voltage (III/2): 320 V, contact surface: Tin, type of contact: Socket, number of potentials: 13, number of rows: 1, number of positions: 13, number of connections: 13, product range: FKCVR 2,5/..-ST, pitch: 5 mm, connection method: Push-in spring connection, conductor/PCB connection direction: 90 °, locking clip: - Locking clip, plug-in system: COMBICON MSTB 2,5, locking: without, mounting: without, type of packaging: packed in cardboard

FKCVW 2,5/13-ST - PCB connector

1910144

<https://www.phoenixcontact.com/us/products/1910144>

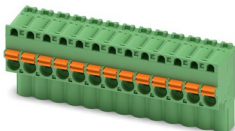

PCB connector, nominal cross section: 2.5 mm², color: green, nominal current: 12 A, rated voltage (III/2): 320 V, contact surface: Tin, type of contact: Socket, number of potentials: 13, number of rows: 1, number of positions: 13, number of connections: 13, product range: FKCVW 2,5/..-ST, pitch: 5 mm, connection method: Push-in spring connection, conductor/PCB connection direction: -90 °, locking clip: - Locking clip, plug-in system: COMBICON MSTB 2,5, locking: without, mounting: without, type of packaging: packed in cardboard

MSTBVA 2,5/13-G - PCB header

1755613

<https://www.phoenixcontact.com/us/products/1755613>



FKC 2,5/13-ST - PCB connector

1910461

<https://www.phoenixcontact.com/us/products/1910461>

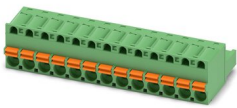

PCB connector, nominal cross section: 2.5 mm², color: green, nominal current: 12 A, rated voltage (III/2): 320 V, contact surface: Tin, type of contact: Socket, number of potentials: 13, number of rows: 1, number of positions: 13, number of connections: 13, product range: FKC 2,5/..-ST, pitch: 5 mm, connection method: Push-in spring connection, conductor/PCB connection direction: 0 °, locking clip: - Locking clip, plug-in system: COMBICON MSTB 2,5, locking: without, mounting: without, type of packaging: packed in cardboard

FKCS 2,5/13-ST - PCB connector

1974847

<https://www.phoenixcontact.com/us/products/1974847>



PCB connector, nominal cross section: 2.5 mm², color: green, nominal current: 12 A, rated voltage (III/2): 320 V, contact surface: Tin, type of contact: Socket, number of potentials: 13, number of rows: 1, number of positions: 13, number of connections: 13, product range: FKCS 2,5/..-ST, pitch: 5 mm, connection method: Push-in spring connection, conductor/PCB connection direction: 0 °, locking clip: - Locking clip, plug-in system: COMBICON MSTB 2,5, locking: without, mounting: without, type of packaging: packed in cardboard

Phoenix Contact 2023 © - all rights reserved
<https://www.phoenixcontact.com>

Phoenix Contact USA
586 Fulling Mill Road
Middletown, PA 17057, United States
(+717) 944-1300
info@phoenixcon.com