

THIS DOCUMENT IS THE PROPERTY OF  
KEYSTONE ELECTRONICS CORP. AND  
SHALL NOT BE REPRODUCED, DISTRIBUTED  
OR USED AS A BASIS FOR MANUFACTURE  
WITHOUT PRIOR WRITTEN PERMISSION  
FROM KEYSTONE ELECTRONICS CORP.

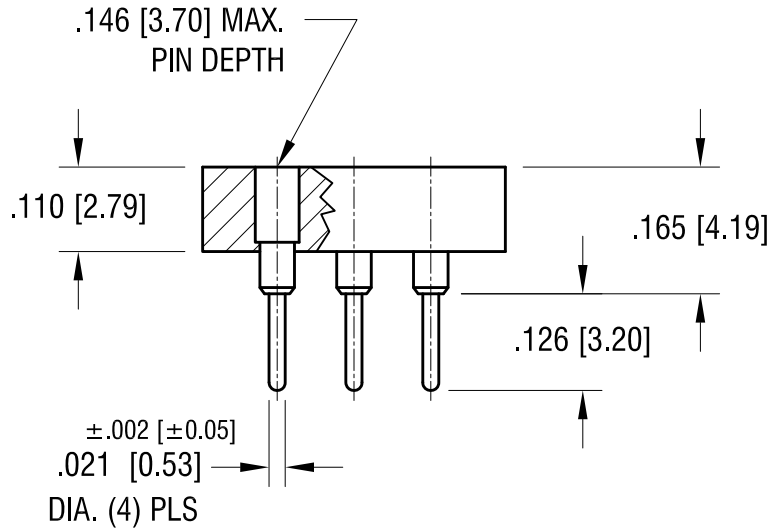
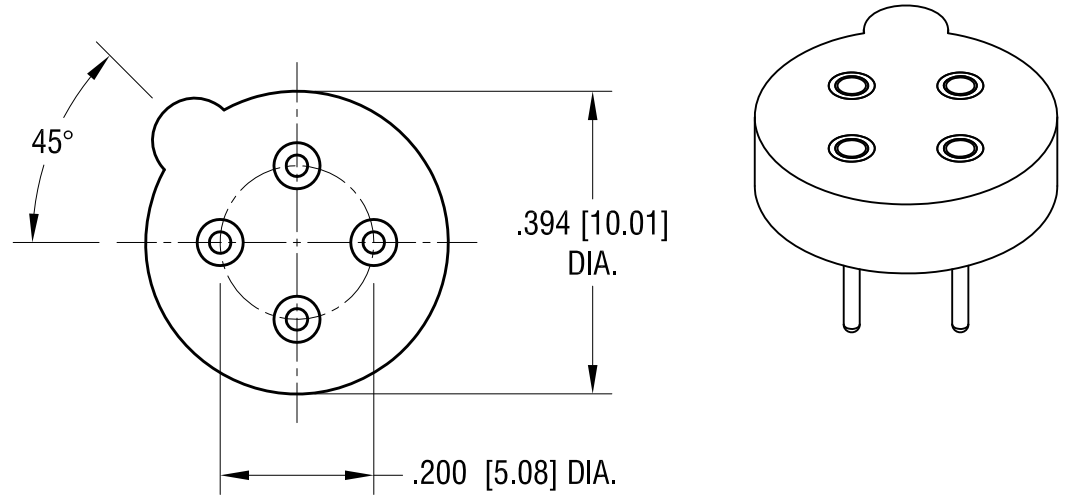

**NOTES:**

- 1. INSULATOR:  
MAT'L - GLASS FILLED POLYESTER
- CONTACT PIN:  
MAT'L - BRASS  
FINISH - TIN PLATE
- CONTACT SPRING:  
MAT'L - BERYLLIUM COPPER  
FINISH - .0000300 [.00076] GOLD PLATE

<b>KEYSTONE ELECTRONICS CORP.</b>			
www.keyelco.com • ASTORIA, N.Y. 11105-2017 • Tel (718) 956-8900			
PART NAME		TRANSISTOR SOCKET FOR TO-5	
MATERIAL AS NOTED			
FINISH AS NOTED		DRN BY BOONE	DATE 7.09.10
		APP'D LN	SCALE 4X
TOLERANCES	INCH [MM]	CODE	DWG NO.
DECIMAL	± .005 [± 0.15]	C/M	<b>4591</b>
ANGULAR	± 1°	UNLESS OTHERWISE SPECIFIED	

DATE	DESCRIPTION	REV.	
------	-------------	------	--

# Mouser Electronics

Authorized Distributor

Click to View Pricing, Inventory, Delivery & Lifecycle Information:

[Keystone Electronics:](#)

[4591](#)