

CATALOG

# Primary switch mode power supplies

## CP-D, CP-E, CP-T, CP-S.1, CP-C.1



- From economic to high-end
- A reliable solution for every application
- Worldwide approvals and support

---

**Available in four different ranges to cover every application requirement, CP range power supplies are used to empower your valued assets worldwide. Their excellent reliability in daily use has under the toughest of conditions and harshest of environments is proven.**

**Choose ABB as your power supply partner and leverage our wide variety of product options. From economic to high-end solutions, the CP range offers maximum value.**

---

# Power supplies

## Table of contents

<b>4</b>	<b>Overview</b>
<b>6</b>	<b>Selection table</b>
<b>9</b>	<b>Power supplies for industrial applications</b>
13	CP-E range
33	CP-T range
47	CP-S.1 range
65	CP-C.1 range
<b>89</b>	<b>Power supplies for building applications</b>
90	CP-D range
<b>103</b>	<b>CP-B range buffer modules</b>
<b>115</b>	<b>Redundancy units</b>
<b>125</b>	<b>Electronic protection devices EPD24</b>
<b>136</b>	<b>Index</b>

# Primary switch mode power supplies

## Overview

Modern power supply units are a vital component in energy management and automation technology. As your global partner in these areas, ABB pays the utmost attention to the resulting requirements. Innovation is the key to ABB's power supply product program.

### Power supplies for industrial applications



#### CP-E range: economy range

The CP-E range offers enhanced functionality while the number of different types has been considerably reduced. Now all power supply units can be operated at an ambient temperature of up to +70 °C. The CP-E range 24 V devices over 18 W offer an output/contact for monitoring of the output voltage and remote diagnosis. Optimized for worldwide applications, the CP-E power supplies can be supplied within a wide range of AC or DC voltages. The output voltage is continuously adjustable, ensuring optimal adaptation to the application, e.g. compensating the voltage drop caused by a long line length. For decoupling of parallel connected power supplies below or equal to 56 V, redundancy modules are available in order to achieve true redundancy.



#### CP-T range: three-phase range

The CP-T range of three-phase power supply units perfectly complements ABB's existing power supply offering in terms of design and functionality, giving you more advanced options for your three-phase applications. Solid state output for function monitoring and remote diagnostics is available. The range is to be used in 340 - 575 V AC or 480 - 820 V DC supply systems. Its continuously adjustable output voltage ensures optimal adaptation to the application, e.g. compensating the voltage drop caused by a long line length.



#### CP-S.1 range: high-efficiency range

CP-S.1 power supplies: high efficiency and reliability delivered in a compact footprint. Designed for a huge variety of applications, including machine building segments, this advanced range boasts an integrated 150 % power reserve for five seconds and operates at an efficiency of up to 94 %. With overheat protection, active power factor correction, a broad certified AC and DC input range and extensive worldwide approvals including marine, the all-new CP-S.1 power supplies are a preferred choice for multiple industrial applications.



# Primary switch mode power supplies

## Overview

### Power supplies for industrial applications



#### CP-C.1 range: high-performance range

The CP-C.1 power supplies are ABB's high-performance and most advanced range. With excellent efficiency, high reliability and innovative functionality, the CP-C.1 range is ready to take on the most demanding industrial applications. These power supplies have a 150 % integrated power reserve and operate at an efficiency of up to 94 %. They are equipped with overheat protection and active power factor correction. Combined with a broad AC and DC input range and extensive worldwide approvals, the CP-C.1 power supplies are the preferred choice for professional DC applications. Giving the power to control.



#### CP-B range: short time buffers

ABB offers an innovative and completely maintenance-free product range for buffering the 24 V DC supply in case of interrupted mains on the primary side of the switch mode power supply.

- Ultra cap based buffer modules for short time UPS systems
- Rated input voltage 24 V DC
- Rated currents 3 A, 10 A and 20 A
- 10 A buffer module with increased capacity to buffer up to 9 min (10 % load)
- LEDs for status indication
- Higher than 90 % efficiency
- Signaling and status outputs
- Buffering times at 100 % load current from 13 s to 50 s (depending on device)

### Power supplies for building applications



#### CP-D range: distribution panel design

The CP-D range of power supply units in MDRC design (modular DIN rail components) fits into all domestic installation and distribution panels. With their width of only 18 to 90 mm, the CP-D range switch mode power supplies are ideally suited for installation in distribution panels. The range is optimized for worldwide applications: The CP-D power supplies can be supplied with 90-264 V AC or 120-375 V DC. The continuously adjustable output voltage (CP-D > 10 W) ensures optimal adaption to the application, e.g. compensating the voltage drop caused by a long line length. An additional redundancy unit CP-D RU to establish true redundancy is available.



For certifications and approvals, please refer to the download section on the product web pages.

# Primary switch mode power supplies

## Selection table - Single-phase

		Order number	Single-phase																			
			CP-C.1					CP-S.1														
Rated output voltage	5 V DC																					
	12 V DC																					
	24 V DC	■	■	■	■	■	■	■	■	■	■	■	■	■	■	■	■	■	■	■	■	
	48 V DC																					
Rated output current	0.42 A																					
	0.625 A																					
	0.75 A																					
	0.83 A																					
	1.25 A																					
	1.3 A																					
	2.1 A																					
	2.5 A																					
	3 A																					
	4.2 A																					
Rated output power	10 W																					
	15 W																					
	18 W																					
	25 W																					
	30 W																					
	60 W																					
	72 W																					
	100 W																					
	120 W	■																				
	240 W		■																			
Rated input voltage	100-240 V AC	■	■	■	■	■	■	■	■	■	■	■	■	■	■	■	■	■	■	■	■	
	110-240 V AC																					
	115/230 V AC auto select																					
	115-230 V AC																					
DC input voltage range	90-300 V DC	■	■	■	■	■	■	■	■	■												
	90-375 V DC																					
	100-250 V DC																					
	110-250 V DC																					
	120-375 V DC																					
Features	Power reserve design	■	■	■	■	■	■	■	■	■	■	■	■	■	■	■	■	■	■	■	■	
	Adjustable output voltage	■	■	■	■	■	■	■	■	■	■	■	■	■	■	■	■	■	■	■	■	
	Integrated input fuse	■	■	■	■	■	■	■	■	■	■	■	■	■	■	■	■	■	■	■	■	
	Short-circuit stable	■	■	■	■	■	■	■	■	■	■	■	■	■	■	■	■	■	■	■	■	
	Fold-forward behavior (U/I)	■	■	■	■	■	■	■	■	■	■	■	■	■	■	■	■	■	■	■	■	
	Fold-back behavior (hiccup)																					
	Power factor correction	act	act	act	act	act	act	act	act	act	act	no	act	act	act	act	act	act	act	act	act	
	Signalling contact	■	■	■	■	■	■	■	■	■	■	■	■	■	■	■	■	■	■	■	■	■
	Extended temp. range					■	■	■														
	Parallel connection	5	5	5	5	5	5	5	5	5	5	3	3	3	3	3	3	3	3	3	3	
	Serial connection	2	2	2	2	2	2	2	2	2	2	2	2	2	2	2	2	2	2	2	2	
	Coated PCBA					■	■	■				■	■	■	■	■	■	■	■	■	■	

pas = passive, act = active

# Primary switch mode power supplies

## Selection table - Single-phase

		Order number																		
		1SVR427033R3000	1SVR427032R1000	1SVR427035R1000	1SVR427030R0000	1SVR427031R0000	1SVR427032R0000	1SVR427034R0000	1SVR427035R0000	1SVR427036R0000	1SVR427030R2000	1SVR427031R2000	1SVR427034R0000	1SVR427035R2000	1SVR427041R1000	1SVR427043R1200	1SVR427041R0000	1SVR427043R0100	1SVR427044R0200	1SVR427045R0400
		Single-phase																		
		CP-E									CP-D									
Rated output voltage	5 V DC	■																		
	12 V DC		■	■											■	■				
	24 V DC				■	■	■	■	■	■						■	■	■	■	■
	48 V DC										■	■	■	■						
Rated output current	0.42 A																			
	0.625 A									■						■				
	0.75 A				■															
	0.83 A														■					
	1.25 A					■							■							
	1.3 A																	■		
	2.1 A															■				
	2.5 A		■						■										■	
	3 A	■																	■	
	4.2 A																			■
	5 A								■					■						
	10 A			■						■						■				
20 A									■											
40 A																				
Rated output power	10 W														■		■			
	15 W	■																		
	18 W				■															
	25 W															■				
	30 W		■			■					■						■			
	60 W						■					■						■		
	72 W																			
	100 W																			■
	120 W			■				■												
	240 W								■					■						
480 W									■					■						
960 W																				
Rated input voltage	100-240 V AC	■	■		■	■	■			■	■			■	■	■	■	■	■	■
	110-240 V AC																			
	115/230 V AC auto select			■				■	■				■							
	115-230 V AC									■				■						
DC input voltage range	90-300 V DC																			
	90-375 V DC		■			■	■				■	■								
	100-250 V DC																			
	110-250 V DC																			
	120-375 V DC	■			■					■					■	■	■	■	■	■
	210-375 V DC			■				■	■					■						
Features	Power reserve design																			
	Adjustable output voltage	■	■	■	■	■	■	■	■	■	■	■	■	■	■	■	■	■	■	■
	Integrated input fuse	■	■	■	■	■	■	■	■	■	■	■	■	■	■	■	■	■	■	■
	Short-circuit stable	■	■	■	■	■	■	■	■	■	■	■	■	■	■	■	■	■	■	■
	Fold-forward behavior (U/I)		■	■		■	■	■	■	■	■	■	■	■		■		■	■	■
	Fold-back behavior (hiccup)	■			■										■		■			
	Power factor correction			pas				pas	pas	act				pas	act					
	Signalling contact					■	■	■	■	■										
	Extended temp. range		■	■		■	■	■	■	■	■	■	■	■	■	■	■	■	■	■
	Parallel connection	■	■	3	■	■	■	3	3	3	■	■	3	3						
	Serial connection	■	■	2	■	■	■	2	2	2	■	■	2	2	■	■	■	■	■	■
	Coated PCBA																			

pas = passive, act = active

# Primary switch mode power supplies

## Selection table - Three-phase

		Order number	1SVR427054R0000	1SVR427055R0000	1SVR427056R0000	1SVR427057R0000	1SVR427054R2000	1SVR427055R2000	1SVR427056R2000
		Three-phase							
		CP-T							
Rated output voltage	24 V DC	■	■	■	■				
	48 V DC						■	■	■
Rated output current	5 A	■					■		
	10 A		■					■	
	20 A			■					■
	40 A				■				
Rated output power	120 W	■							
	240 W		■				■		
	480 W			■				■	
	960 W				■				■
Rated input voltage	3 x 400-500 V AC	■	■	■	■	■	■	■	■
DC input voltage range	480-820 V DC	■	■	■	■	■	■	■	■
Features	Adjustable output voltage	■	■	■	■	■	■	■	■
	Integrated input fuse	■	■	■	■	■	■	■	■
	Short-circuit stable	■	■	■	■	■	■	■	■
	Fold forward behavior (U/I)	■	■	■			■	■	
	Fold back behavior (hiccup)	■	■	■	■	■	■	■	■
	Extended temp. range	■	■	■	■	■	■	■	■
	Signalling contact	■	■	■	■				
	Parallel connection		2	2	2	2	2	2	2
	Serial connection		2	2	2	2	2	2	2



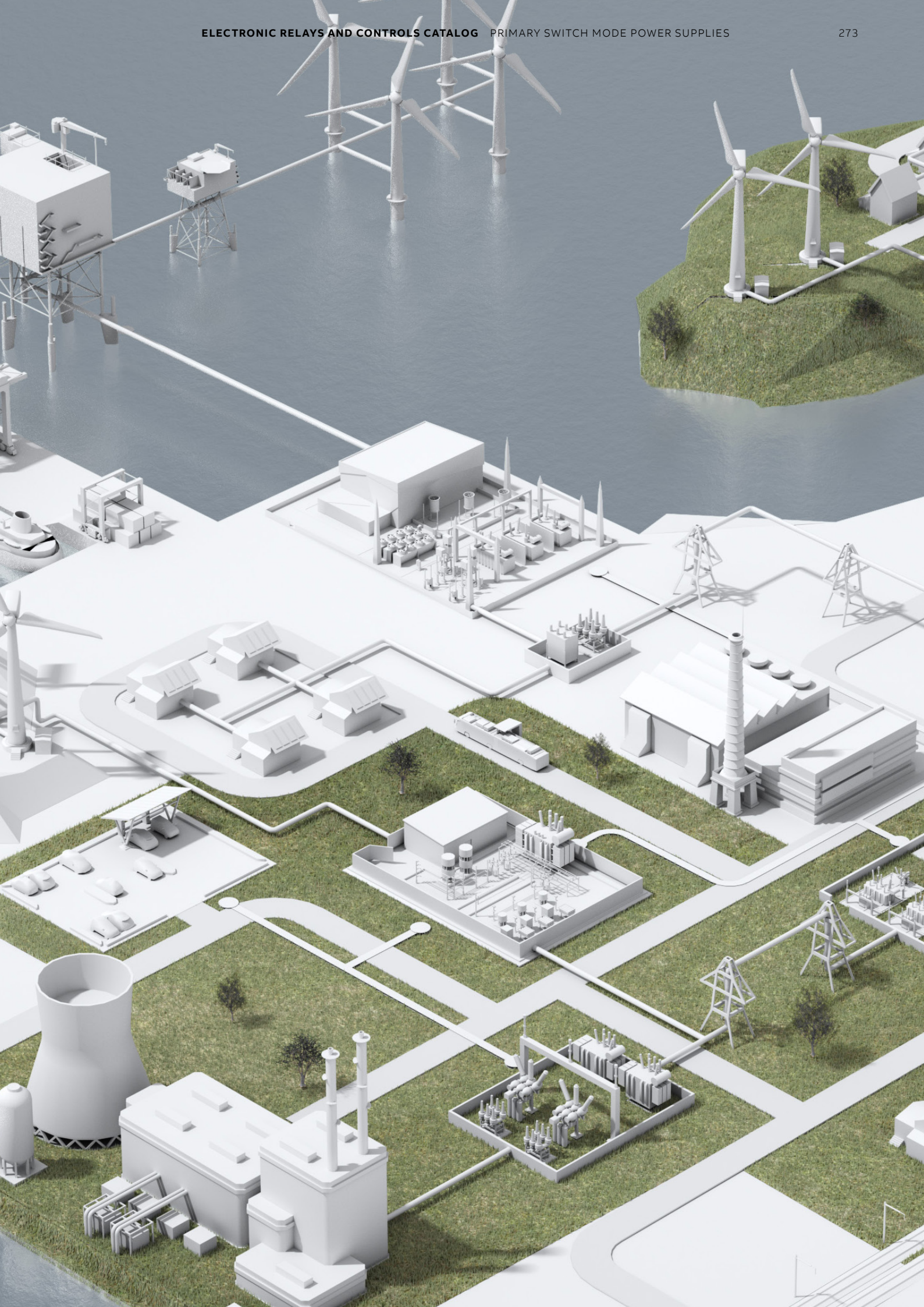





---

# Power supplies for industrial applications

## Table of contents

<b>13</b>	<b>CP-E range</b>
<b>33</b>	<b>CP-T range</b>
<b>47</b>	<b>CP-S.1 range</b>
<b>65</b>	<b>CP-C.1 range</b>





---

## **CP-E range**

### Table of contents

<b>14</b>	<b>Benefits and advantages</b>
<b>16</b>	<b>Operating controls</b>
<b>17</b>	<b>Applications</b>
<b>18</b>	<b>Ordering details</b>
<b>19</b>	<b>Technical data</b>
<b>29</b>	<b>Technical diagrams</b>

## CP-E range

### Benefits and advantages



ABB's CP-E range offers enhanced functionality and a simpler, more rational selection process. All power supply units can be operated at an ambient temperature of up to +70 °C (158 °F).



**Affordable range**

Products with exactly the functions you require.  
Designed for best possible price-performance ratio.



**Global availability**

The product can be used in any installations in the world. Giving you the confidence of worldwide sourcing – no matter where you build, install or operate your equipment.



**Speed up your projects**

Data available for common planning software: Less engineering time required.

# CP-E range

## Benefits and advantages



### Characteristics

- Output voltages 5 V, 12 V, 24 V, 48 V DC
- Adjustable output voltages
- Output currents 0.625 A / 0.75 A / 1.25 A / 2.5 A / 3 A / 5 A / 10 A / 20 A
- Power range 15 W, 18 W, 30 W, 60 W, 120 W, 240 W, 480 W
- High efficiency, up to 90 %
- Low power dissipation and low heating
- Free convection cooling (no forced cooling with ventilators)
- Open-circuit, overload and short-circuit stable
- Integrated input fuse
- U/I characteristic curve on devices > 18 W (fold-forward behavior at overload – no switch-off)
- Redundancy units offering true redundancy
- LED(s) for status indication
- Signalling output/contact for output voltage OK
  - Transistor on 24 V devices > 18 W and < 120 W
  - Solid-state on 24 V devices ≥ 120 W
- Various approvals and marks



### Main benefits

#### Signalling output / contact

The CP-E range 24 V devices > 18 W offer an output/contact for monitoring of the output voltage and remote diagnosis.

#### Wide range input

Optimized for worldwide applications: The CP-E power supplies can be supplied with a wide range of AC or DC voltages.

#### Adjustable output voltage

A continuously adjustable output voltage ensures optimal adaptation to the application, e.g. compensating the voltage drop caused by a long line length.

#### Redundancy units

For decoupling of parallelized power supply units ≤ 40 A. Thus, true redundancy can be achieved.

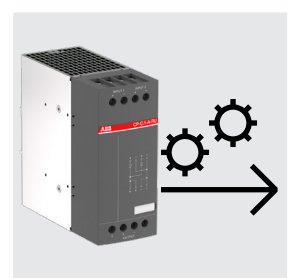
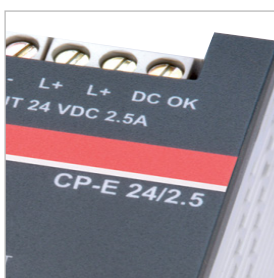

# CP-E range

## Operating controls

**OUTPUT Adjust:**  
Potentiometer -  
adjustment of  
output voltage

**Single/parallel:**  
Sliding switch -  
adjustment of  
single or parallel  
operation

**OUTPUT**  
**L+, L+, L-, L-:**  
Terminals - output  
5 V / 12 V / 24 V /  
48 V

**13-14:**  
Terminals -  
signalling contact  
(or solid-state)

**Indication of  
operational states:**  
OUTPUT OK:  
green LED - output  
voltage OK  
OUTPUT LOW:  
red LED - output  
voltage too low

**Circuit diagram**

**INPUT L, N, PE:**  
**terminals - input**  
90-132 V AC, 180-265 V AC / 210-375 V DC  
90-264 V AC / 120-375 V DC  
85-264 V AC / 90-375 V DC

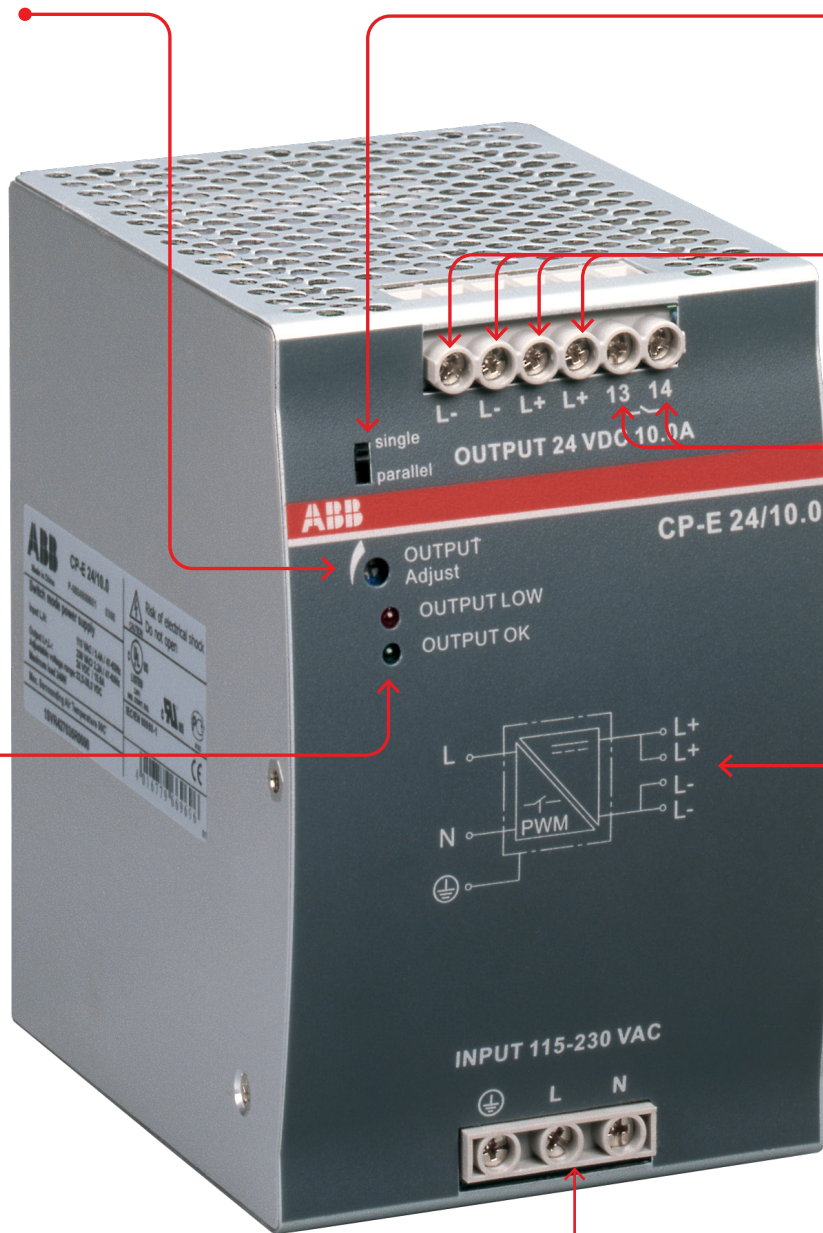



# CP-E range Applications



Tooling machines



Packaging industry



Food industry



Textile industry



Printing industry



Electro-mobility

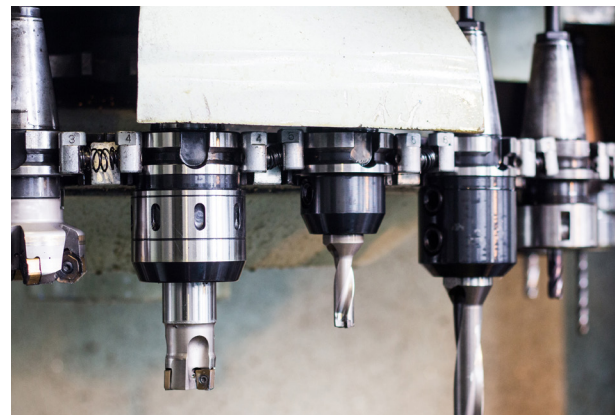
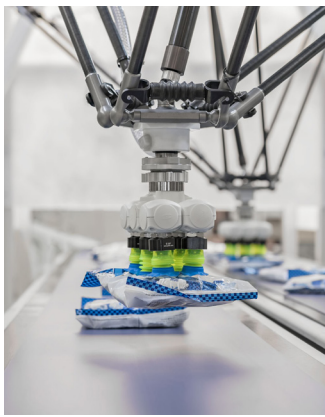

# CP-E range

## Ordering details



2CDC 271 017 F0006

CP-E 5/3.0



2CDC 271 013 F0006

CP-E 12/2.5



2CDC 271 028 F0008

CP-E 48/5.0



2CDC 271 027 F0008

CP-E 24/20.0

### Description

This range offers types with output voltages from 5 V DC to 48 V DC at output currents of 0.625 A to 20 A. With their high thermal efficiency of up to 90 %, these power supplies have very low power and heat dissipation and can be operated without forced cooling. The functionality has been enhanced while the number of different types has been considerably reduced. Of course, all power supplies of the CP-E range are approved in accordance with all relevant international standards.

### Ordering details - CP-E < 100 W

Input voltage range	Rated output voltage / current	Type	Order code	Weight (1 pc.) kg (lb)
90-264 V AC / 120-375 V DC	5 V DC / 3 A	CP-E 5/3.0	1SVR427033R3000	0.15 (0.33)
85-264 V AC / 90-375 V DC	12 V DC / 2.5 A	CP-E 12/2.5	1SVR427032R1000	0.29 (0.64)
90-132 V AC, 180-264 V AC / 210-375 V DC	12 V DC / 10 A	CP-E 12/10.0	1SVR427035R1000	1.00 (2.20)
90-264 V AC / 120-375 V DC	24 V DC / 0.75 A	CP-E 24/0.75	1SVR427030R0000	0.15 (0.33)
85-264 V AC / 90-375 V DC	24 V DC / 1.25 A	CP-E 24/1.25	1SVR427031R0000	0.29 (0.64)
85-264 V AC / 90-375 V DC	24 V DC / 2.5 A	CP-E 24/2.5	1SVR427032R0000	0.36 (0.79)

### Ordering details - CP-E ≥ 120 W

Input voltage range	Rated output voltage / current	Type	Order code	Weight (1 pc.) kg (lb)
90-132 V AC, 180-264 V AC / 210-375 V DC	24 V DC / 5 A	CP-E 24/5.0	1SVR427034R0000	1.00 (2.20)
90-132 V AC, 180-264 V AC / 210-375 V DC	24 V DC / 10 A	CP-E 24/10.0	1SVR427035R0000	1.36 (3.01)
90-264 V AC / 120-375 V DC	24 V DC / 20 A	CP-E 24/20.0	1SVR427036R0000	1.90 (4.18)
85-264 V AC / 90-375 V DC	48 V DC / 0.625 A	CP-E 48/0.62	1SVR427030R2000	0.29 (0.64)
85-264 V AC / 90-375 V DC	48 V DC / 1.25 A	CP-E 48/1.25	1SVR427031R2000	0.36 (0.79)
90-132 V AC, 180-264 V AC / 210-375 V DC	48 V DC / 5 A	CP-E 48/5.0	1SVR427034R2000	1.36 (3.01)
90-264 V AC / 120-375 V DC	48 V DC / 10 A	CP-E 48/10.0	1SVR427035R2000	1.90 (4.19)



## CP-E range

### Technical data

Data at  $T_a = 25\text{ °C}$ ,  $U_{in} = 230\text{ V AC}$  and rated values, unless otherwise indicated

Type		CP-E 5/3.0	CP-E 12/2.5	CP-E 12/10.0
<b>Input circuit</b>		<b>L, N</b>		
Rated input voltage $U_{in}$		100-240 V AC		115 / 230 V AC auto select
Input voltage range		90-264 V AC / 120-375 V DC	85-264 V AC / 90-375 V DC	90-132 V AC, 180-264 V AC / 210-375 V DC
Frequency range AC		47-63 Hz		
Typical input current	at 115 V AC	335 mA	560 mA	2.2 A
	at 230 V AC	210 mA	330 mA	0.83 A
Typical power consumption		19.8 W	35.9 W	143 W
Inrush current	at 115 V AC	15 A	20 A	24 A
	at 230 V AC	30 A	40 A	48 A
Discharge current	input / output	0.25 mA		
	input / PE	3.5 mA		
Power failure buffering time	at 115 V AC	min. 20 ms	min. 20 ms	min. 25 ms
	at 230 V AC	min. 75 ms	min. 30 ms	min. 30 ms
Internal input fuse		2 A slow-acting / 250 V AC		3.15 A slow-acting / 250 V AC
Power factor correction (PFC)		no		yes, passive, 0.7
<b>Indication of operational states</b>				
Output voltage	green LED	OK: : output voltage OK	OUTPUT OK: : output voltage OK	OUTPUT OK: : output voltage OK
	red LED	LOW: : output voltage too low	-	OUTPUT LOW: : output voltage too low
<b>Output circuit</b>		<b>L+, L-</b>	<b>L+, L+, L-, L-</b>	
Rated output voltage		5 V DC	12 V DC	
Tolerance of the output voltage		0...+1 %		
Adjustment range of the output voltage		4.5-5.75 V DC	12-14 V DC	11.4-14.5 V DC
Rated output power		15 W	30 W	120 W
Rated output current $I_r$	$T_a \leq 60\text{ °C}$	3.0 A	2.5 A	10 A
Derating of the output current	$60\text{ °C} < T_a \leq 70\text{ °C}$	2.5 %/°C		2.5 %/°C
Maximum deviation with	load change statical	±2 %	±0.5 %	±1 % (single mode) ±5 % (parallel mode)
	change of output voltage within the input voltage range	±1 %	±0.5 %	±0.5 %
Recovery time $T_R$		< 2 ms		
Starting time after applying the supply voltage	at $I_r$	max. 1 s		
	with 3500 $\mu\text{F}$	-	max. 2 s	-
	with 7000 $\mu\text{F}$	max. 1.5 s	-	max. 1.5 s
Rise time	at rated load	max. 150 ms		
	with 3500 $\mu\text{F}$	-	max. 500 ms	-
	with 7000 $\mu\text{F}$	max. 500 ms	-	max. 500 ms
Fall time		max. 150 ms		
Residual ripple and switching peaks	BW = 20 MHz	50 mV		
Parallel connection		yes, to enable redundancy		configurable, to increase power, up to 3 devices, min. 0.1 $I_r$ - max. 0.9 $I_r$
Series connection		yes, to increase voltage		yes, to increase voltage, max. 2 devices
Resistance to reverse feed		1 s - max. 7.5 V DC	1 s - max. 18 V DC	max. 18 V DC
<b>Output circuit - No-load, overload and short-circuit behavior</b>				
Characteristic curve of output		hiccup-mode	U/I characteristic curve	
Short-circuit protection		continuous short-circuit proof		
Short-circuit behavior		Hiccup-mode	continuation with output power limiting	
Overload protection		output power limiting		
No-load protection		continuous no-load stability		
Starting of capacitive loads		7000 $\mu\text{F}$	3500 $\mu\text{F}$	7000 $\mu\text{F}$

## CP-E range

### Technical data

Data at  $T_a = 25\text{ °C}$ ,  $U_{in} = 230\text{ V AC}$  and rated values, unless otherwise indicated

Type		CP-E 5/3.0	CP-E 12/2.5	CP-E 12/10.0
<b>General data</b>				
Power loss		typ. 5 W	typ. 5.6 W	typ. 24 W
Efficiency		typ. 75 %	typ. 84 %	typ. 84 %
Duty cycle		100 %		
Dimensions		see "Dimensional drawings"		
Material of housing		plastic		metal
Mounting		DIN rail (IEC/EN 60715), snap-on mounting without any tool		
Mounting position		horizontal		
Minimum distance to other units	horizontal / vertical	25 mm / 25 mm (0.98 in / 0.98 in)		
Degree of protection	housing / terminals	IP20 / IP20		
Protection class		I		
<b>Electrical connection - input circuit / output circuit</b>				
Connecting capacity	fine-strand with wire end ferrule			0.2-4 mm <sup>2</sup> (24-11 AWG)
	fine-strand without wire end ferrule	0.2-2.5 mm <sup>2</sup> (24-14 AWG)		0.2-6 mm <sup>2</sup> (24-10 AWG)
	rigid			
Stripping length		6 mm (0.24 in)		8 mm (0.31 in)
Tightening torque	input / output	0.6 Nm (5 lb.in)		1.0 Nm (9 lb.in) / 0.62 Nm (5.5 lb.in)
<b>Environmental data</b>				
Ambient temperature range	operation	-20...+70 °C	-40...+70 °C	-35...+70 °C
	rated load	-20...+60 °C	-40...+60 °C	-35...+60 °C
	storage	-20...+85 °C	-40...+85 °C	-40...+85 °C
Damp heat		95 RH, % without condensation		
Vibration (sinusoidal) (IEC/EN 60068-2-6)		10-500 Hz, 2 G, along X, Y, Z each axis, 60 min. for each axis		
Shock (half-sine) (IEC/EN 60068-2-27)		15 G, 11 ms, 3 axes, 6 faces, 3 times for each face		
<b>Isolation data</b>				
Rated insulation voltage $U_i$	input circuit / output circuit	3 kV AC		
	input / PE	1.5 kV AC		
	output / PE	0.5 kV AC; 0.71 kV DC		
Pollution degree		2		
Overvoltage category		II		
<b>Standards / Directives</b>				
Standards		IEC/EN62368-1		
Low Voltage Directive		2014/35/EU		
EMC Directive		2014/30/EU		
RoHS Directive		2011/65/EU		
Protective low voltage		SELV (IEC60950-1)		
<b>Electromagnetic compatibility</b>				
Interference immunity to		IEC/EN 61000-6-2		
electrostatic discharge	IEC/EN 61000-4-2	level 4 (air discharge 15 kV / contact discharge 8 kV)		
radiated, radio-frequency, electromagnetic field	IEC/EN 61000-4-3	level 3 (10 V/m)		
electrical fast transient/burst	IEC/EN 61000-4-4	level 4 (4 kV / 2,5 kHz)	level 4 (4 kV / 5 kHz)	
surge	IEC/EN 61000-4-5	L-L level 3 (2 kV) / L-PE level 4 (4 kV)		
conducted disturbances, induced by radio-frequency fields	IEC/EN 61000-4-6	level 3 (10 V)		
power frequency magnetic fields	IEC/EN 61000-4-8	level 4 (30 A/m)		
voltage dips, short interruptions and voltage variations	IEC/EN 61000-4-11	dip: >95 % 10 ms / >30 % 500 ms interruptions: >95 % 5000 ms		
Interference emission		IEC/EN 61000-6-3		
high-frequency radiated		class B		
high-frequency conducted		class B		
limits for harmonic current emissions	IEC/EN 61000-3-2	class D	class A	class D



## CP-E range

### Technical data

Data at  $T_a = 25\text{ °C}$ ,  $U_{in} = 230\text{ V AC}$  and rated values, unless otherwise indicated

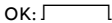
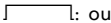
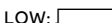
Type		CP-E 24/0.75	CP-E 24/1.25	CP-E 24/2.5
<b>Input circuit</b>		<b>L, N</b>		
Rated input voltage $U_{in}$		100-240 V AC		
Input voltage range		90-264 V AC / 120-375 V DC	85-264 V AC / 90-375 V DC	
Frequency range AC		47-63 Hz		
Typical input current	at 115 V AC	335 mA	560 mA	1060 mA
	at 230 V AC	210 mA	330 mA	590 mA
Typical power consumption		22.8 W	36.7 W	69.2 W
Inrush current	at 115 V AC	15 A	20 A (max. 3 ms)	30 A
	at 230 V AC	30 A	40 A (max. 3 ms)	60 A
Discharge current	input / output	0.25 mA		
	input / PE	3.5 mA		
Power failure buffering time	at 115 V AC	min. 20 ms	min. 20 ms	
	at 230 V AC	min. 75 ms	min. 30 ms	
Internal input fuse		2 A slow-acting / 250 V AC		
Power factor correction (PFC)		no		
<b>Indication of operational states</b>				
Output voltage	green LED	OK:  : output voltage OK	OUTPUT OK:  : output voltage OK	
	red LED	LOW:  : output voltage too low	-	-
<b>Output circuit</b>		<b>L+,L-</b>	<b>L+, L+, L-, L-</b>	
Rated output voltage		24 V DC		
Tolerance of the output voltage		0 ... +1 %		
Adjustment range of the output voltage		21.6-28.8 V DC	24-28 V DC	
Rated output power		18 W	30 W	60 W
Rated output current $I_r$	$T_a \leq 60\text{ °C}$	0.75 A	1.25 A	2.5 A
Derating of the output current	$60\text{ °C} < T_a \leq 70\text{ °C}$	2.5 %/°C		
Signalling output for output voltage OK	DC OK	-	transistor	
Maximum deviation with	load change statical	±2 %	±0.5 %	
	change of output voltage within the input voltage range	±1 %	±0.5 %	
Recovery time $T_r$		< 2 ms		
Starting time after applying the supply voltage	at $I_r$	max. 1 s		
	with 3500 $\mu\text{F}$	-	max. 2 s	-
	with 7000 $\mu\text{F}$	max. 1.5 s	-	max. 1.5 s
Rise time	at rated load	max. 150 ms		
	with 3500 $\mu\text{F}$	-	max. 500 ms	-
	with 7000 $\mu\text{F}$	max. 500 ms	-	max. 500 ms
Fall time		max. 150 ms		
Residual ripple and switching peaks	BW = 20 MHz	50 mV		
Parallel connection		yes, to enable redundancy		
Series connection		yes, to increase voltage		
Resistance to reverse feed		1 s - max. 35 V DC		
<b>Output circuit - No-load, overload and short-circuit behavior</b>				
Characteristic curve of output		hiccup-mode	U/I characteristic curve	
Short-circuit protection		continuous short-circuit proof		
Short-circuit behavior		hiccup-mode	continuation with output power limiting	
Overload protection		output power limiting		
No-load protection		continuous no-load stability		
Starting of capacitive loads		7000 $\mu\text{F}$	3500 $\mu\text{F}$	7000 $\mu\text{F}$

## CP-E range

### Technical data

Data at  $T_a = 25\text{ °C}$ ,  $U_{in} = 230\text{ V AC}$  and rated values, unless otherwise indicated

Type		CP-E 24/0.75	CP-E 24/1.25	CP-E 24/2.5
<b>General data</b>				
Power loss		typ. 4.45 W	typ. 5.5 W	typ. 8.8 W
Efficiency		typ. 77 %	typ. 86 %	typ. 89 %
Duty cycle		100 %		
Dimensions		see "Dimensional drawings"		
Material of housing		plastic		
Mounting		DIN rail (IEC/EN 60715), snap-on mounting without any tool		
Mounting position		horizontal		
Minimum distance to other units	horizontal / vertical	25 mm / 25 mm (0.98 in / 0.98 in)		
Degree of protection	housing / terminals	IP20 / IP20		
Protection class		I		
<b>Electrical connection - input circuit / output circuit</b>				
Connecting capacity	fine-strand with wire end ferrule	0.2-2.5 mm <sup>2</sup> (24-14 AWG)		
	fine-strand without wire end ferrule			
	rigid			
Stripping length		6 mm (0.24 in)		
Tightening torque	input / output	0.6 Nm (5 lb.in)		
<b>Environmental data</b>				
Ambient temperature range	operation	-20...+70 °C	-40...+70 °C	
	rated load	-20...+60 °C	-40...+60 °C	
	storage	-20...+85 °C	-40...+85 °C	
Damp heat (cyclic) (IEC/EN 60068-2-30)		95 % RH, without condensation		
Vibration (sinusoidal) (IEC/EN 60068-2-6)		10-500 Hz, 2 G, along X, Y, Z each axis, 60 min. for each axis		
Shock (half-sine) (IEC/EN 60068-2-27)		15 G, 11 ms, 3 axes, 6 faces, 3 times for each face		
<b>Isolation data</b>				
Rated insulation voltage $U_i$	input circuit / output circuit	3 kV AC		
	input / PE	1.5 kV AC		
	output / PE	0.5 kV AC; 0.71 kV DC		
Pollution degree		2		
Overvoltage category		II		
<b>Standards / Directives</b>				
Standards		IEC/EN62368-1		
Low Voltage Directive		2014/35/EU		
EMC Directive		2014/30/EU		
RoHS Directive		2011/65/EU		
Protective low voltage		SELV (IEC60950-1)		
<b>Electromagnetic compatibility</b>				
Interference immunity to		IEC/EN 61000-6-2		
electrostatic discharge	IEC/EN 61000-4-2	level 4 (air discharge 15 kV / contact discharge 8 kV)		
radiated, radio-frequency, electromagnetic field	IEC/EN 61000-4-3	level 3 (10 V/m)		
electrical fast transient/burst	IEC/EN 61000-4-4	level 4 (4 kV / 2.5 kHz)	level 4 (4 kV / 5 kHz)	
surge	IEC/EN 61000-4-5	L-L level 3 (2 kV) / L-PE level 4 (4 kV)		
conducted disturbances, induced by radio-frequency fields	IEC/EN 61000-4-6	level 3 (10 V)		
power frequency magnetic fields	IEC/EN 61000-4-8	level 4 (30 A/m)		
voltage dips, short interruptions and voltage variations	IEC/EN 61000-4-11	dip: >95 % 10 ms / >30 % 500 ms, interruptions: >95 % 5000 ms		
Interference emission		IEC/EN 61000-6-3		
high-frequency radiated		class B		
high-frequency conducted		class B		
limits for harmonic current emissions	IEC/EN 61000-3-2	class D	class A	

## CP-E range

### Technical data

Data at  $T_a = 25\text{ °C}$ ,  $U_{in} = 230\text{ V AC}$  and rated values, unless otherwise indicated

Type		CP-E 24/5.0	CP-E 24/10.0	CP-E 24/20.0
<b>Input circuit</b>		<b>L, N</b>		
Rated input voltage $U_{in}$		115 / 230 V AC auto select		115-230 V AC
Input voltage range		90-132 V AC, 180-264 V AC / 210-375 V DC	90-132 V AC, 180-264 V AC / 210-375 V DC	90-264 V AC, 120-375 V DC
Frequency range AC		47-63 Hz		
Typical input current	at 115 V AC	2.2 A	4.0 A	4.9 A
	at 230 V AC	0.83 A	1.55 A	2.5 A
Typical power consumption		140 W	270 W	539 W
Inrush current	at 115 V AC	24 A (max. 5 ms)	30 A (max. 5 ms)	25 A (max. 5 ms)
	at 230 V AC	48 A (max. 5 ms)	60 A (max. 5 ms)	50 A (max. 5 ms)
Discharge current	input / output	0.25 mA		
	input / PE	3.5 mA		
Power failure buffering time	at 115 V AC	min. 25 ms		
	at 230 V AC	min. 30 ms		
Internal input fuse		3.15 A slow-acting / 250 V AC	6.3 A slow-acting / 250 V AC	10 A slow-acting / 250 V AC
Power factor correction (PFC)		yes, passive, 0.7	yes, passive, 0.75	yes, active 115 V AC: 0.99 230 V AC: 0.97
<b>Indication of operational states</b>				
Output voltage	green LED	OUTPUT OK: <input type="checkbox"/> : output voltage OK		
	red LED	OUTPUT LOW: <input type="checkbox"/> : output voltage too low		
<b>Output circuit</b>		<b>L+, L+, L-, L-</b>		
Rated output voltage		24 V DC		
Tolerance of the output voltage		0...+1 %		
Adjustment range of the output voltage		22.5-28.5 V DC		
Rated output power		120 W	240 W	480 W
Rated output current $I_o$	$T_a \leq 60\text{ °C}$	5 A	10 A	-
	$T_a \leq 55\text{ °C}$	-	-	20 A
Derating of the output current	$60\text{ °C} < T_a \leq 70\text{ °C}$	2.5 %/°C		-
	$55\text{ °C} < T_a \leq 70\text{ °C}$	-	-	2.5 %/°C
Signalling contact for output voltage OK	13-14	solid-state (max. 60 V DC, 0.3 A)		
Minimum fuse rating to achieve short-circuit protection	13-14	$\geq 60\text{ V DC}$ , $\leq 0.3\text{ A}$ fast-acting		
Maximum deviation with	load change statical	$\pm 1\%$ (single mode), $\pm 5\%$ (parallel mode)		
	change of output voltage within the input voltage range	$\pm 0.5\%$		
Recovery time $T_R$		< 2 ms		
Starting time after applying the supply voltage	at $I_o$	max. 1 s	2.5 s (at $-40\text{ °C}$ / 90 V AC starting time >2.5 s has to be expected)	max. 1 s
	with 3500 $\mu\text{F}$	max. 1.5 s	-	-
	with 7000 $\mu\text{F}$	-	2.5 s	max. 1.5 s
Rise time	at rated load	max. 150 ms		
	with 3500 $\mu\text{F}$	max. 500 ms	-	-
	with 7000 $\mu\text{F}$	-	max. 500 ms	-
Fall time		max. 150 ms		
Residual ripple and switching peaks	BW = 20 MHz	50 mV	100 mV	
Parallel connection		configurable, to increase power, up to 3 devices, min. $0.1 I_f$ - max. $0.9 I_f$		
Series connection		yes, to increase voltage, max. 2 devices		
Resistance to reverse feed		max. 35 V DC		

## CP-E range

### Technical data

Data at  $T_a = 25\text{ °C}$ ,  $U_{in} = 230\text{ V AC}$  and rated values, unless otherwise indicated

Type	CP-E 24/5.0	CP-E 24/10.0	CP-E 24/20.0	
<b>Output circuit - No-load, overload and short-circuit behavior</b>				
Characteristic curve of output	U/I characteristic curve			
Short-circuit protection	continuous short-circuit proof			
Short-circuit behavior	continuation with output power limiting			
Overload protection	output power limiting			
No-load protection	continuous no-load stability			
Starting of capacitive loads	3500 $\mu\text{F}$	7000 $\mu\text{F}$		
<b>General data</b>				
Power loss	typ. 20 W	typ. 35 W	typ. 63 W	
Efficiency	typ. 86 %	typ. 89 %	typ. 89 %	
Duty cycle	100 %			
Dimensions	see "Dimensional drawings"			
Material of housing	metal			
Mounting	DIN rail (IEC/EN 60715), snap-on mounting without any tool			
Mounting position	horizontal			
Minimum distance to other units	horizontal / vertical	25 mm / 25 mm (0.98 in / 0.98 in)		
Degree of protection	housing / terminals	IP20 / IP20		
Protection class	I			
<b>Electrical connection - input circuit / output circuit</b>				
Connecting capacity	fine-strand with wire end ferrule	0.2-4 mm <sup>2</sup> (24-11 AWG)		
	fine-strand without wire end ferrule	0.2-6 mm <sup>2</sup> (24-10 AWG)		
	rigid			
Stripping length	8 mm (0.31 in)			
Tightening torque	input / output	1.0 Nm (9 lb.in) / 0.62 Nm (5.5 lb.in)		
<b>Environmental data</b>				
Ambient temperature range	operation	-35...+70 °C	-40...+70 °C	
	rated load	-35...+60 °C	-40...+60 °C	-40...+55 °C
	storage	-40...+85 °C	-40...+85 °C	
Damp heat (cyclic) (IEC/EN 60068-2-30)	95 % RH, without condensation			
Vibration (sinusoidal) (IEC/EN 60068-2-6)	10-500 Hz, 2 G, along X, Y, Z each axis, 60 min. for each axis			
Shock (half-sine) (IEC/EN 60068-2-27)	15 G, 11 ms, 3 axes, 6 faces, 3 times for each face			
<b>Isolation data</b>				
Rated insulation voltage $U_i$	input circuit / output circuit	3 kV AC		
	input / PE	1.5 kV AC		
	output / PE	0.5 kV AC; 0.71 kV DC		
	signalling contact / PE	0.5 kV DC		
Pollution degree	2			
Overvoltage category	II			
<b>Standards / Directives</b>				
Standards	IEC/EN 62368-1			
Low Voltage Directive	2014/35/EU			
EMC Directive	2014/30/EU			
RoHS Directive	2011/65/EU			
Protective low voltage	SELV (IEC60950-1)			

## CP-E range

### Technical data



Data at  $T_a = 25\text{ °C}$ ,  $U_{in} = 230\text{ V AC}$  and rated values, unless otherwise indicated

Type		CP-E 24/5.0	CP-E 24/10.0	CP-E 24/20.0
<b>Electromagnetic compatibility</b>				
Interference immunity to		IEC/EN 61000-6-2		
electrostatic discharge	IEC/EN 61000-4-2	level 4 (air discharge 15 kV / contact discharge 8 kV)		
radiated, radio-frequency, electromagnetic field	IEC/EN 61000-4-3	level 3 (10 V/m)		
electrical fast transient/burst	IEC/EN 61000-4-4	level 4 (4 kV / 5 kHz)	level 4 (4 kV / 2.5 kHz)	
surge	IEC/EN 61000-4-5	L-L level 3 (2 kV) / L-PE level 4 (4 kV)		
conducted disturbances, induced by radio-frequency fields	IEC/EN 61000-4-6	level 3 (10 V)		
power frequency magnetic fields	IEC/EN 61000-4-8	level 4 (30 A/m)		
voltage dips, short interruptions and voltage variations	IEC/EN 61000-4-11	dip: >95 % 10 ms / >30 % 500 ms interruptions: >95 % 5000 ms		
Interference emission		IEC/EN 61000-6-3		
high-frequency radiated		class B		
high-frequency conducted		class B		
limits for harmonic current emissions	IEC/EN 61000-3-2	class D		

## CP-E range

### Technical data

Data at  $T_a = 25\text{ °C}$ ,  $U_{in} = 230\text{ V AC}$  and rated values, unless otherwise indicated

Type	CP-E 48/0.62	CP-E 48/1.25	CP-E 48/5.0	CP-E 48/10.0
<b>Input circuit</b>	<b>L, N</b>			
Rated input voltage $U_{in}$	100-240 V AC		115 / 230 V AC auto select	115-230 V AC
Input voltage range	85-264 V AC / 90-375 V DC		90-132 V AC, 180-264 V AC / 210-375 V DC	90-264 V AC, 120-375 V DC
Frequency range AC	47-63 Hz			
Typical input current	at 115 V AC	560 mA	1060 mA	4.0 A
	at 230 V AC	330 mA	590 mA	1.55 A
Typical power consumption		35.7 W	69.0 W	267 W
Inrush current	at 115 V AC	20 A	30 A	30 A (max. 5 ms)
	at 230 V AC	40 A	60 A	60 A (max. 5 ms)
Discharge current	input / output	0.25 mA		
	input / PE	3.5 mA		
Power failure buffering time	at 115 V AC	min. 20 ms		min. 25 ms
	at 230 V AC	min. 30 ms		min. 25 ms
Internal input fuse	2 A slow-acting / 250 V AC		6.3 A slow-acting / 250 V AC	10 A slow-acting / 250 V AC
Power factor correction (PFC)	no		yes, passive, 0.7	yes, active 115 V AC: 0.99 230 V AC: 0.97
<b>Indication of operational states</b>				
Output voltage	green LED	OUTPUT OK:  : output voltage OK		
	red LED	-	-	OUTPUT LOW:  : output voltage too low
<b>Output circuit</b>	<b>L+, L+, L-, L-</b>			
Rated output voltage	48 V DC			
Tolerance of the output voltage	0...+1 %			
Adjustment range of the output voltage	48-55 V DC		47-56 V DC	
Rated output power	30 W	60 W	240 W	480 W
Rated output current $I_r$	$T_a \leq 60\text{ °C}$	0.625 A	1.25 A	5 A
	$T_a \leq 55\text{ °C}$	-	-	10 A
Derating of the output current	$60\text{ °C} < T_a \leq 70\text{ °C}$	2.5 %/°C		
	$55\text{ °C} < T_a \leq 70\text{ °C}$	-	-	2.5 %/°C
Signalling output for output voltage OK	DC OK	-	-	-
Maximum deviation with	load change statical	±0.5 %		±1 % (single mode) ±5 % (parallel mode)
	change of output voltage within the input voltage range	±0.5 %		±0.5 %
Recovery time $T_r$	< 2 ms			
Starting time after applying the supply voltage	at $I_r$	max. 1 s		
	with 3500 $\mu\text{F}$	max. 2 s	-	-
	with 7000 $\mu\text{F}$	-	max. 1.5 s	max. 1.5 s
Rise time	at rated load	max. 150 ms		
	with 3500 $\mu\text{F}$	max. 500 ms	-	-
	with 7000 $\mu\text{F}$	-	max. 500 ms	max. 500 ms
Fall time	max. 150 ms			
Residual ripple and switching peaks	BW = 20 MHz	50 mV		100 mV
Parallel connection	yes, to enable redundancy		configurable, to increase power, up to 3 devices, min. 0.1 $I_r$ - max. 0.9 $I_r$	
Series connection	yes, to increase voltage		yes, to increase voltage, max. 2 devices	
Resistance to reverse feed	1 s - max. 63 V DC			



## CP-E range

### Technical data

Data at  $T_a = 25\text{ °C}$ ,  $U_{in} = 230\text{ V AC}$  and rated values, unless otherwise indicated

Type	CP-E 48/0.62	CP-E 48/1.25	CP-E 48/5.0	CP-E 48/10.0
<b>Output circuit - No-load, overload and short-circuit behavior</b>				
Characteristic curve of output	U/I characteristic curve			
Short-circuit protection	continuous short-circuit proof			
Short-circuit behavior	continuation with output power limiting			
Overload protection	output power limiting			
No-load protection	continuous no-load stability			
Starting of capacitive loads	3500 $\mu\text{F}$	7000 $\mu\text{F}$	unlimited	7000 $\mu\text{F}$
<b>General data</b>				
Power loss	typ. 4.9 W	typ. 7.8 W	typ. 32 W	typ. 60 W
Efficiency	typ. 86 %	typ. 89 %	typ. 90 %	
Duty cycle	100 %			
Dimensions	see "Dimensional drawings"			
Material of housing	plastic		metal	
Mounting	DIN rail (IEC/EN 60715), snap-on mounting without any tool			
Mounting position	horizontal			
Minimum distance to other units	horizontal / vertical	25 mm / 25 mm (0.98 in / 0.98 in)		
Degree of protection	housing / terminals	IP/20 / IP20		
Protection class	I			
<b>Electrical connection - input circuit / output circuit</b>				
Connecting capacity	fine-strand with wire end ferrule	0.2-2.5 mm <sup>2</sup> (24-14 AWG)		0.2-4 mm <sup>2</sup> (24-11 AWG)
	fine-strand without wire end ferrule			0.2-6 mm <sup>2</sup> (24-10 AWG)
	rigid			
Stripping length		6 mm (0.24 in)	8 mm (0.31 in)	
Tightening torque	input / output	0.6 Nm (5 lb.in)		1.0 Nm (9 lb.in) / 0.62 Nm (5.5 lb.in)
<b>Environmental data</b>				
Ambient temperature range	operation	-40...+70 °C		
	rated load	-40...+60 °C		-40...+55 °C
	storage	-40...+85 °C		
Damp heat (cyclic) (IEC/EN 60068-2-30)	95 % RH, without condensation			
Vibration (sinusoidal) (IEC/EN 60068-2-6)	10-500 Hz, 2 G, along X, Y, Z each axis, 60 min. for each axis			
Shock (half-sine) (IEC/EN 60068-2-27)	15 G, 11 ms, 3 axes, 6 faces, 3 times for each face			
<b>Isolation data</b>				
Rated insulation voltage $U_i$	input circuit / output circuit	3 kV AC		
	input / PE	1.5 kV AC		
	output / PE	0.5 kV AC; 0.71 kV DC		
Pollution degree	2			
Overvoltage category	II			
<b>Standards / Directives</b>				
Standards	IEC/EN 62368-1			
Low Voltage Directive	2014/35/EU			
EMC Directive	2014/30/EU			
RoHS Directive	2011/65/EU			
Protective low voltage	SELV (IEC60950-1)			

## CP-E range

### Technical data

Data at  $T_a = 25\text{ °C}$ ,  $U_{in} = 230\text{ V AC}$  and rated values, unless otherwise indicated

Type	CP-E 48/0.62	CP-E 48/1.25	CP-E 48/5.0	CP-E 48/10.0
<b>Electromagnetic compatibility</b>				
Interference immunity to	IEC/EN 61000-6-2			
electrostatic discharge	IEC/EN 61000-4-2	level 4 (air discharge 15 kV / contact discharge 8 kV)		
radiated, radio-frequency, electromagnetic field	IEC/EN 61000-4-3	level 3 (10 V/m)		
electrical fast transient/burst	IEC/EN 61000-4-4	level 4 (4 kV / 5 kHz)	level 4 (4 kV / 2.5 kHz)	
surge	IEC/EN 61000-4-5	L-L level 3 (2 kV) / L-PE level 4 (4 kV)		
conducted disturbances, induced by radio-frequency fields	IEC/EN 61000-4-6	level 3 (10 V/m)		
power frequency magnetic fields	IEC/EN 61000-4-8	level 4 (30 A/m)		
voltage dips, short interruptions and voltage variations	IEC/EN 61000-4-11	dip: >95 % 10 ms / >30 % 500 ms, interruptions: >95 % 5000 ms		
Interference emission	IEC/EN 61000-6-3			
high-frequency radiated	class B			
high-frequency conducted	class B			
limits for harmonic current emissions	IEC/EN 61000-3-2	class A	class D	

# CP-E range

## Technical diagrams

### Output curve at $T_a = 25^\circ\text{C}$

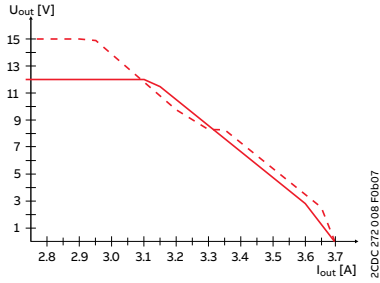

CP-E 12/2.5

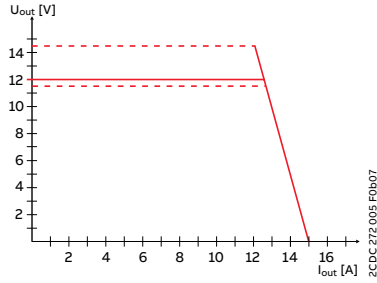

CP-E 12/10.0

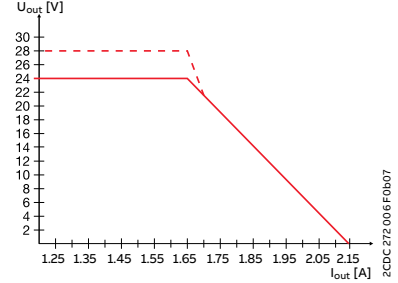

CP-E 24/1.25

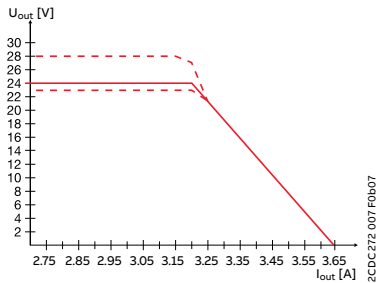

CP-E 24/2.5

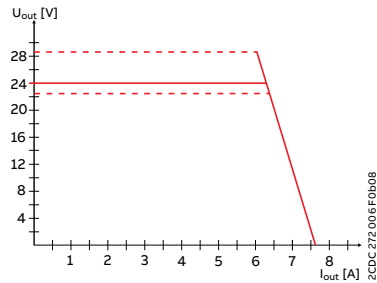

CP-E 24/5.0

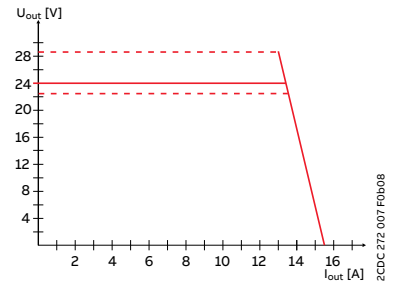

CP-E 24/10.0

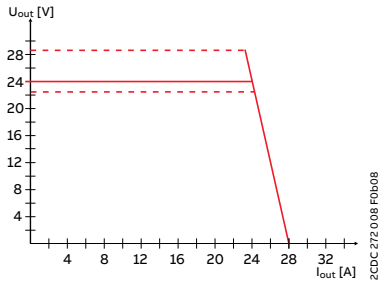

CP-E 24/20.0

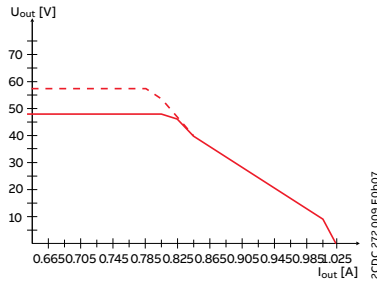

CP-E 48/0.62

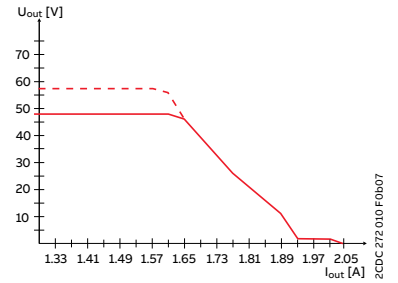

CP-E 48/1.25

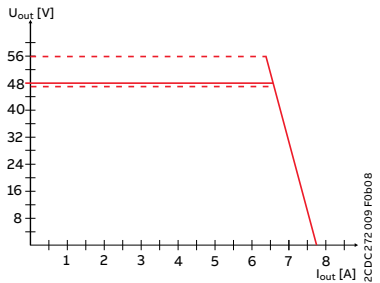

CP-E 48/5.0

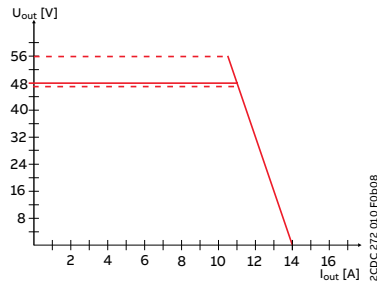

CP-E 48/10.0

# CP-E range

## Technical diagrams

### Temperature behavior

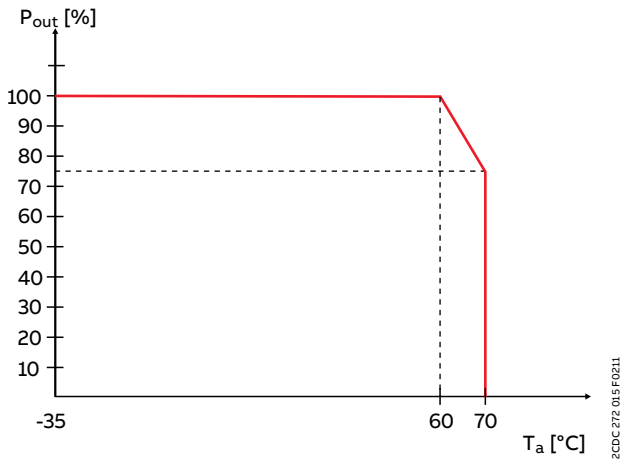

CP-E 12/10.0, CP-E 24/5.0

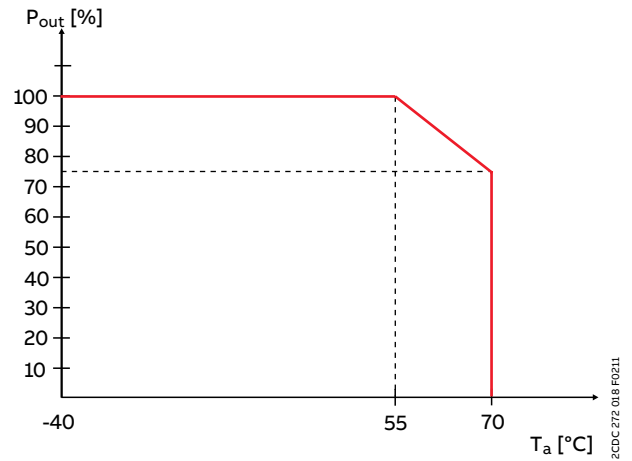

CP-E 24/20.0, CP-E 48/10.0

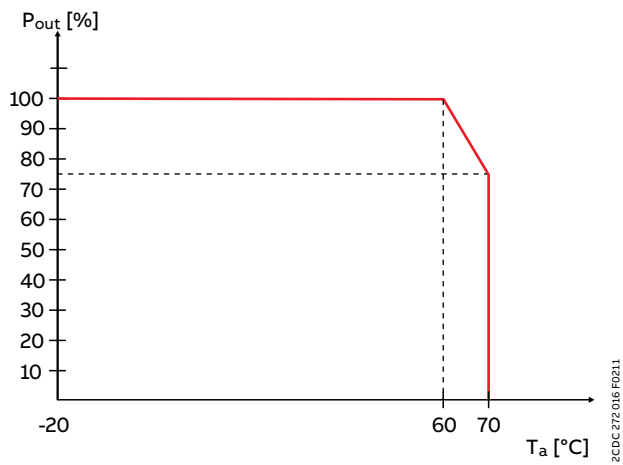

CP-E 5/3.0, CP-E 24/0.75

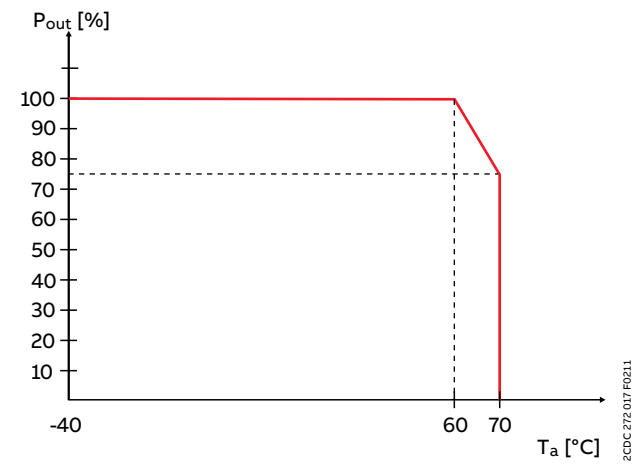

CP-E 12/2.5, CP-E 24/1.25, CP-E 48/0.62,  
CP-E 24/2.5, CP-E 48/1.25, CP-E 24/10.0, CP-E 48/5.0

# CP-E range

## Technical diagrams

### Wiring instructions

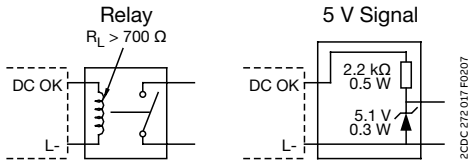

CP-E 24/1.25, CP-E 24/2.5

### Dimensional drawings

Dimensions in mm and inches

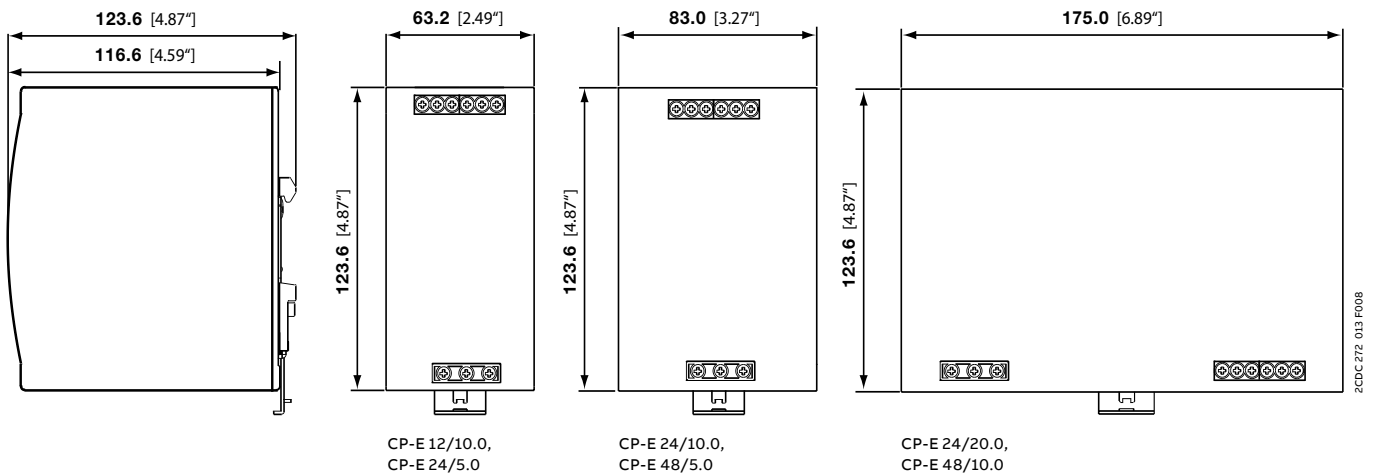
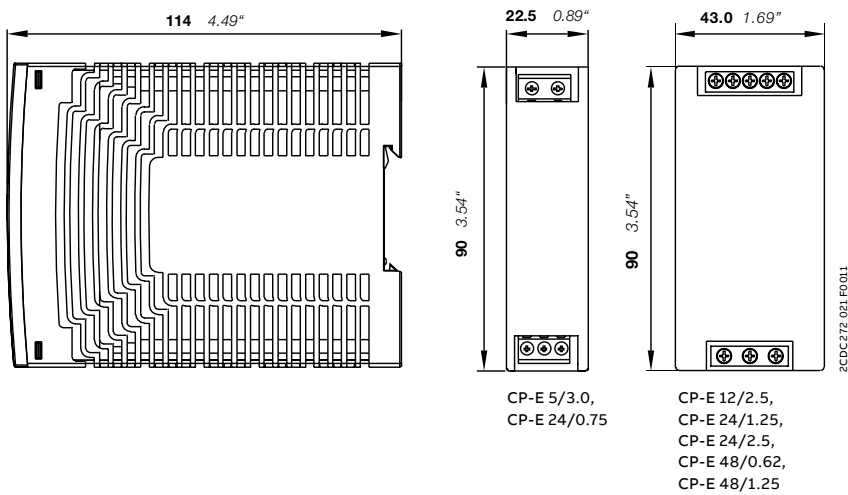





---

## **CP-T range**

### Table of contents

<b>34</b>	<b>Benefits and advantages</b>
<b>36</b>	<b>Operating controls</b>
<b>37</b>	<b>Applications</b>
<b>38</b>	<b>Ordering details</b>
<b>39</b>	<b>Technical data</b>
<b>43</b>	<b>Technical diagrams</b>

## CP-T range

### Benefits and advantages



ABB's CP-T range of three-phase power supply units perfectly complements our existing power supply offering in terms of design and functionality, giving you more advanced options for your three-phase applications.



**Affordable range**

Products with exactly the functions you require. Designed for best price-performance ratio.



**Global availability**

The product can be used in any installation in the world. Giving you the confidence of world-wide sourcing – no matter where you build, install or operate your equipment.



**Speed up your projects**

Data available for common planning software: Less engineering time required

# CP-T range

## Benefits and advantages



### Characteristics

- Rated output voltages 24 V, 48 V DC
- Output voltage adjustable via front-facing rotary potentiometer “OUTPUT Adjust”
- Rated output currents 5 A, 10 A, 20 A, 40 A
- Rated output powers 120 W, 240 W, 480 W, 960 W
- Three-phase operation (see derating note)
- Two-phase operation (25 % derating possible, see derating note)
- Supply range 3 x 400–500 V AC (3 x 340-575 V AC, 480-820 V DC)
- Typical efficiency of 93 %
- Low power dissipation and low heating
- Free convection cooling (no forced cooling with ventilators)
- Ambient temperature range during operation -40...+70 °C <sup>1)</sup>
- Open-circuit, overload and short-circuit stable
- Integrated input fuse
- Redundancy unit CP-C.1-A-RU (-C) offering true redundancy, available as accessory
- LEDs for status indication
- Signalling contact "13-14" (solid-state) for output voltage OK on 24 V devices
- Various approvals and marks

<sup>1)</sup> 480 W variants: -30...+70°C



### Main benefits

#### Signalling output

Some devices of the CP-T series offer a solid-state output for function monitoring and remote diagnostics.

#### Wide input range

Optimized for worldwide applications: The CP-T power supplies can be used in 340 - 575 V AC or 480 - 820 V DC supply systems.

#### Adjustable output voltage

The CP-T range features a continuously adjustable output voltage. Thus, they can be optimally adapted to the applications, e.g. compensating the voltage drop caused by a long line length.





# CP-T range

## Operating controls

### Indication of operational states

- OUTPUT OK:  
green LED -  
output voltage OK
- OUTPUT LOW:  
red LED -  
output voltage  
too low

### Circuit diagram

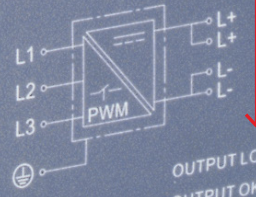

**INPUT L1, L2, L3, PE:**  
Terminals - input  
340-575 V AC /  
480-820 V DC

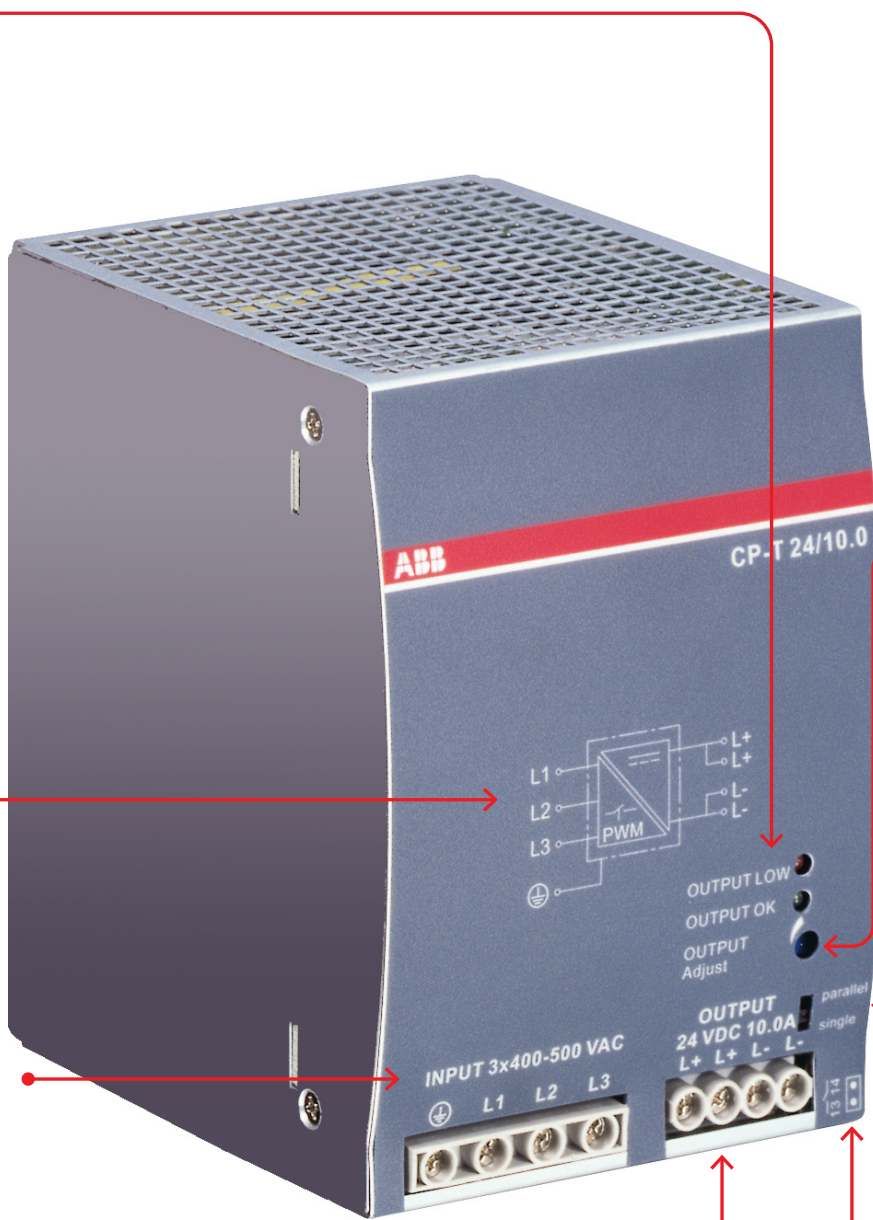

**OUTPUT Adjust:**  
Potentiometer -  
adjustment of  
output voltage  
22.5...28.5V DC

**Single/parallel:**  
Sliding switch -  
adjustment of  
single or parallel  
operation

**OUTPUT L+, L+, L-, L-:**  
Terminals - output  
24 V DC, 48 V DC

**13-14:**  
**Terminals - signalling contact**  
A solid-state output  
indicates the error-free  
operation of the  
output voltage





**Tunnel drilling machines**



**Quality power management systems**



**Floor conveyors**

## CP-T range

### Ordering details



2CDC271.043.50009

CP-T 24/5.0



2CDC271.045.50009

CP-T 24/10.0, CP-T 48/5.0



2CDC271.047.50009

CP-T 24/20.0, CP-T 48/10.0

### Description

In terms of design and functionality, the CP-T range perfectly supplements the existing products and extends the range appropriately. The devices can be supplied with a three-phase voltage as well as with two-phase mains. Here, ABB offers power supply units with 24 V DC and 48 V DC outputs with 5 A, 10 A, 20 A and 40 A and efficiency of up to 93 %.

As in the case of all products, they are designed for an ambient temperature of up to 70 °C. All products can be supplied within an AC supply voltage range between 340 to 575 V AC and a DC supply voltage range between 480 to 820 V DC.

### Ordering details

Input voltage range	Rated output voltage / current	Type	Order code	Weight (1 pc.) kg (lb)
340-575 V AC / 480-820 V DC	24 V DC / 5 A	CP-T 24/5.0	1SVR427054R0000	0.80 (1.77)
340-575 V AC / 480-820 V DC	24 V DC / 10 A	CP-T 24/10.0	1SVR427055R0000	1.05 (2.31)
340-575 V AC / 480-820 V DC	24 V DC / 20 A	CP-T 24/20.0	1SVR427056R0000	1.75 (3.86)
340-575 V AC / 480-820 V DC	24 V DC / 40 A	CP-T 24/40.0	1SVR427057R0000	3.20 (7.05)
340-575 V AC / 480-820 V DC	48 V DC / 5 A	CP-T 48/5.0	1SVR427054R2000	1.05 (2.31)
340-575 V AC / 480-820 V DC	48 V DC / 10 A	CP-T 48/10.0	1SVR427055R2000	1.75 (3.86)
340-575 V AC / 480-820 V DC	48 V DC / 20 A	CP-T 48/20.0	1SVR427056R2000	3.40 (7.50)

## CP-T range

### Technical data

Data at  $T_a = 25\text{ °C}$ ,  $U_{in} = 3 \times 400\text{ V AC}$  and rated values, unless otherwise indicated

Type	CP-T 24/5.0	CP-T 24/10.0	CP-T 24/20.0	CP-T 24/40.0
<b>Input circuit</b>	<b>L1, L2, L3</b>			
Rated input voltage $U_{in}$	3 x 400-500 V AC			
Input voltage range	340-575 V AC 480-820 V DC			
Frequency range AC	47-63 Hz			
Typical input current	0.36 A	0.65 A	1.1 A	1.72 A
Typical power consumption	135 W	270 W	538 W	1058 W
Inrush current	typ. 10 A		20 A	
Power failure buffering time	min. 20 ms			min. 15 ms
Internal input fuse	per phase 2 A / 600 V AC		T 3.15 A / 500 V AC	T 5 A / 500 V AC
Recommended backup fuse	3 pole miniature circuit breaker ABB Type S203			
Power factor correction (PFC)	yes, passive			
Discharge current	towards PE		< 3.5 mA	
	input / output		< 0.25 mA	
<b>Indication of operational states</b>				
Output voltage	OUTPUT OK: green LED	output voltage OK when the output voltage > 75 % of the rated output voltage		
	OUTPUT LOW: red LED	output voltage too low when the output voltage < 70 % of the rated output voltage		
<b>Output circuit</b>	<b>L+, L+, L-, L-</b>			
Rated output voltage	24 V DC			
Tolerance of the output voltage	0...+1 %			
Adjustment range of the output voltage	22.5-28.5 V DC			
Rated output power	120 W	240 W	480 W	960 W
Rated output current $I_r$	$T_a \leq 60\text{ °C}$		5 A	
	$60\text{ °C} < T_a \leq 70\text{ °C}$		10 A	
Derating of the output current	$60\text{ °C} < T_a \leq 70\text{ °C}$			2.5 %/°C
Signalling contact for output voltage OK	13-14	solid-state (max. 60 V DC, 0.3 A)		
	Threshold	17.6-19.4 V		
	Insulation voltage	500 V DC		
Minimum fuse rating to achieve short-circuit protection	13-14	$\geq 60\text{ V DC}$ , $\leq 0.3\text{ A}$ fast-acting		
Maximum deviation with load change statical	$\pm 1\%$		$\pm 1\%$ (single mode)	
	-		$\pm 5\%$ (parallel mode)	
	change of output voltage within the input voltage range		$\pm 0.5\%$	
Recovery time $T_A$	at nominal load		< 2 ms	
Starting time after applying the supply voltage	at $I_r$		max. 1 s	
	with 3500 $\mu\text{F}$		max. 1.5 s	
Rise time	at nominal load		max. 150 ms	
	with 3500 $\mu\text{F}$		max. 500 ms	
Fall time	max. 150 ms			
Residual ripple and switching peaks	BW = 20 MHz		100 mV	
Parallel connection	not supported	configurable, to increase power, up to 2 devices, min. 0.1 $I_r$ - max 0.9 $I_r$		to increase power, up to 2 devices, min. 0.1 $I_r$ - max. 0.9 $I_r$ , use active current balancing
Series connection	not supported	yes, to increase voltage, max. 2 devices		
Resistance to reverse feed	approx. 35 V			
<b>Output circuit - No-load, overload and short-circuit behavior</b>				
Characteristic curve of output	combined U/I characteristic curve and hiccup mode		U/I- or hiccup-mode adjustable	hiccup / fold back behavior
Short-circuit protection	continuous short-circuit proof			
Short-circuit behavior	current limiting			
Overload protection	hiccup mode			
No-load protection	continuous no-load stability			
Overtemperature protection	yes, automatic recovery after temperature went down			
Starting of capacitive loads	3500 $\mu\text{F}$	7000 $\mu\text{F}$	7000 $\mu\text{F}$	7000 $\mu\text{F}$

## CP-T range

### Technical data

Data at  $T_a = 25\text{ °C}$ ,  $U_{in} = 3 \times 400\text{ V AC}$  and rated values, unless otherwise indicated

Type		CP-T 24/5.0	CP-T 24/10.0	CP-T 24/20.0	CP-T 24/40.0
<b>General data</b>					
Efficiency		typ. 89 %	typ. 90 %		typ. 92 %
Duty cycle		100 %			
Dimensions		see "Dimensional drawings"			
Material of housing		metal			
Mounting		DIN rail (IEC/EN 60715), snap-on mounting without any tool			
Mounting position		horizontal			
Minimum distance to other units	horizontal / vertical	25 mm / 25 mm (0.98 in / 0.98 in)			
Degree of protection	housing / terminals	IP20 / IP20			
Protection class		I			
<b>Electrical connection - input circuit / output circuit / signalling circuit</b>					
Connecting capacity	fine-strand with wire end ferrule	0.2-4 mm <sup>2</sup> (24-11 AWG)			
	fine-strand without wire end ferrule	0.2-6 mm <sup>2</sup> (24-10 AWG)			
	rigid	0.2-6 mm <sup>2</sup> (24-10 AWG)			
Stripping length		8 mm (0.31 in)			
Tightening torque	input / output	1 Nm (9 lb.in) / 0.6 Nm (5.5 lb.in)			1 Nm (9 lb.in) / 1.8 Nm (15.6 lb.in)
<b>Environmental data</b>					
Ambient temperature range	operation	-40...+70 °C		-30...+70 °C	-40...+70 °C
	rated load	-40...+60 °C		-30...+60 °C	-40...+60 °C
	storage	-40...+85 °C			
Altitude during operation	IEC/EN 60068-2-13	max. 5000 m			
Damp heat (cyclic) (IEC/EN 60068-2-30)		95 % without condensation			
Vibration (sinusoidal) (IEC/EN 60068-2-6)		10-500 Hz, 2G, each along X, Y, Z axes 60 min / cycle			
Shock (half-sine) (IEC/EN 60068-2-27)		15 g, 11 ms, 3 axes, 6 faces, 3 times for each face			
<b>Isolation data</b>					
Rated insulation voltage $U_i$	input circuit / output circuit	3 kV AC			
	input / PE	1.5 kV AC			
	output / PE	0.5 kV AC; 0.71 kV DC			
	signalling output / PE	0.5 kV DC			
Pollution degree		2			
<b>Standards / Directives</b>					
Standards		IEC/EN 62368-1			
Low Voltage Directive		2014/35/EU			
EMC Directive		2014/30/EU			
RoHS Directive		2011/65/EU			
Protective low voltage		SELV (IEC60950-1)			
<b>Electromagnetic compatibility</b>					
Interference immunity to		IEC/EN 61000-6-2			
electrostatic discharge	IEC/EN 61000-4-2	level 4 (air discharge 15 kV / contact discharge 8 kV)			
radiated, radio-frequency, electromagnetic field	IEC/EN 61000-4-3	level 3 (10 V/m)			
electrical fast transient/burst	IEC/EN 61000-4-4	level 4 (4 kV / 2.5 kHz)	level 4 (4 kV / 5 kHz)		
surge	IEC/EN 61000-4-5	L-L level 3 (2 kV) / L-PE level 4 (4 kV)			
conducted disturbances, induced by radio-frequency fields	IEC/EN 61000-4-6	level 3 (10 V)			
power frequency magnetic fields	IEC/EN 61000-4-8	level 4 (30 A/m)			
voltage dips, short interruptions and voltage variations	IEC/EN 61000-4-11	dips: >95 % 0.5 ms / >30 % 0.5 ms, interruptions: >95 % 250 ms			
Interference emission		IEC/EN 61000-6-3			
high-frequency radiated		class B			
high-frequency conducted		class B			
limits for harmonic current emissions	IEC/EN 61000-3-2	class A			

## CP-T range

### Technical data

Data at  $T_a = 25\text{ °C}$ ,  $U_{in} = 3 \times 400\text{ V AC}$  and rated values, unless otherwise indicated

Type	CP-T 48/5.0	CP-T 48/10.0	CP-T 48/20.0
<b>Input circuit</b>	<b>L1, L2, L3</b>		
Rated input voltage $U_{in}$	3 x 400-500 V AC		
Input voltage range	340-575 V AC 480-820 V DC		
Frequency range AC	47-63 Hz		
Typical input current	0.65 A	1.1 A	1.72 A
Typical power consumption	264 W	535 W	1050 W
Inrush current	typ. 20 A		30 A
Power failure buffering time	min. 20 ms		min. 15 ms
Internal input fuse	per phase 2 A / 600 V AC	T 3.15 A / 500 V AC	T 5 A / 500 V AC
Power factor correction (PFC)	yes, passive		
Discharge current	towards PE	< 3.5 mA	
	input / output	< 0.25 mA	
<b>Indication of operational states</b>			
Output voltage	OUTPUT OK: green LED	output voltage OK when the output voltage > 75 % of the rated output voltage	
	OUTPUT LOW: red LED	output voltage too low when the output voltage < 70 % of the rated output voltage	
<b>Output circuit</b>	<b>L+, L+, L-, L-</b>		
Rated output voltage	48 V DC		
Tolerance of the output voltage	0...+1 %		
Adjustment range of the output voltage	47-56 V DC		
Rated output power	240 W	480 W	960 W
Rated output current $I_r$	$T_a \leq 60\text{ °C}$ 5 A	10 A	20 A
Derating of the output current	$60\text{ °C} < T_a \leq 70\text{ °C}$	2.5 %/°C	
Maximum deviation with	load change statical	$\pm 1\%$ (single mode) $\pm 5\%$ (parallel mode)	
	change of output voltage within the input voltage range	$\pm 0.5\%$	
Recovery time $T_A$	at rated load	< 2 ms	
Starting time after applying the supply voltage	at $I_r$	max. 1 s	
	with 7000 $\mu\text{F}$	max. 1.5 s	
Rise time	at rated load	max. 150 ms	
	with 7000 $\mu\text{F}$	max. 500 ms	
Fall time		max. 150 ms	
Residual ripple and switching peaks	BW = 20 MHz	100 mV	80 mV
Parallel connection		configurable, to increase power, up to 2 devices, min. 0.1 $I_r$ - max 0.9 $I_r$	to increase power, up to 2 devices, min. 0.1 $I_r$ - max. 0.9 $I_r$ , use active current balancing
Series connection		yes, to increase voltage, max. 2 devices	
Resistance to reverse feed		approx. 35 V	approx. 63 V
		approx. 63 V	approx. 63 V
<b>Output circuit - No-load, overload and short-circuit behavior</b>			
Characteristic curve of output	combined U/I and hiccup mode	U/I or hiccup mode, configurable	hiccup mode / fold back behavior
Short-circuit protection	continuous short-circuit proof		
Short-circuit behavior	current limiting		
Overload protection	hiccup mode		
No-load protection	continuous no-load stability		
Over temperature protection	yes, automatic recovery after temperature went down		
Starting of capacitive loads	7000 $\mu\text{F}$		

## CP-T range

### Technical data

Data at  $T_a = 25\text{ °C}$ ,  $U_{in} = 3 \times 400\text{ V AC}$  and rated values, unless otherwise indicated

Type		CP-T 48/5.0	CP-T 48/10.0	CP-T 48/20.0
<b>General data</b>				
Efficiency		typ. 91 %		typ. 93 %
Duty cycle		100%		
Dimensions		see "Dimensional drawings"		
Material of housing		Metal		
Mounting		DIN rail (IEC/EN 60715), snap-on mounting without any tool		
Mounting position		horizontal		
Minimum distance to other units	horizontal / vertical	25 mm / 25 mm (0.98 in / 0.98 in)		
Degree of protection	housing / terminals	IP20 / IP20		
Protection class		I		
<b>Electrical connection - input circuit / output circuit</b>				
Connecting capacity	fine-strand with wire end ferrule	0.2-4 mm <sup>2</sup> (24-11 AWG)		0.2-4 mm <sup>2</sup> (24-11 AWG) / 0.5-10 mm <sup>2</sup> (20-8 AWG)
		0.2-6 mm <sup>2</sup> (24-10 AWG)		
	rigid			
Stripping length		8 mm (0.31 in)		
Tightening torque	input / output	1 Nm (9 lb.in) / 0.6 Nm (5.5 lb.in)		1 Nm (9 lb.in) / 1.8 Nm (15.6 lb.in)
<b>Environmental data</b>				
Ambient temperature range	operation	-40...+70 °C	-30...+70 °C	-40...+70 °C
	rated load	-40...+60 °C	-30...+60 °C	-40...+60 °C
	storage	-40...+85 °C	-40...+85 °C	-40...+85 °C
Altitude during operation	IEC/EN 60068-2-13	max. 5000 m		
Damp heat (cyclic) (IEC/EN 60068-2-30)		95 % without condensation		
Vibration (sinusoidal) (IEC/EN 60068-2-6)		10-500 Hz, 2G, each along X, Y, Z axes 6 min / cycle		
Shock (half-sine) (IEC/EN 60068-2-27)		15G, 11 ms, 3 axes, 6 Faces, 3 times for each face		
<b>Isolation data</b>				
Rated insulation voltage $U_i$	input circuit / output circuit	3 kV AC		
	input / PE	1.5 kV AC		
	output / PE	0.5 kV AC; 0.71 kV DC		
Pollution degree		2		
<b>Standards / Directives</b>				
Standards		IEC/EN 62368-1		
Low Voltage Directive		2014/35/EU		
EMC Directive		2014/30/EU		
RoHS Directive		2011/65/EU		
Protective low voltage		SELV (IEC60950-1)		
<b>Electromagnetic compatibility</b>				
Interference immunity to		IEC/EN 61000-6-2		
electrostatic discharge	IEC/EN 61000-4-2	level 4 (air discharge 15 kV / contact discharge 8 kV)		
radiated, radio-frequency, electromagnetic field	IEC/EN 61000-4-3	level 3 (10 V/m)		
electrical fast transient/burst	IEC/EN 61000-4-4	level 4 (4 kV / 5 kHz)		
surge	IEC/EN 61000-4-5	L-L level 3 (2 kV) / L-PE level 4 (4 kV)		
conducted disturbances, induced by radio-frequency fields	IEC/EN 61000-4-6	level 3 (10 V)		
power frequency magnetic fields	IEC/EN 61000-4-8	level 4 (30 A/m)		
voltage dips, short interruptions and voltage variations	IEC/EN 61000-4-11	dips: >95 % 0.5 ms / >30 % 0.5 ms interruptions: >95 % 250 ms		
Interference emission		IEC/EN 61000-6-3		
high-frequency radiated		class B		
high-frequency conducted		class B		
limits for harmonic current emissions	IEC/EN 61000-3-2	class A		



# CP-T range

## Technical diagrams

### Output curves at $T_a = 25^\circ\text{C}$

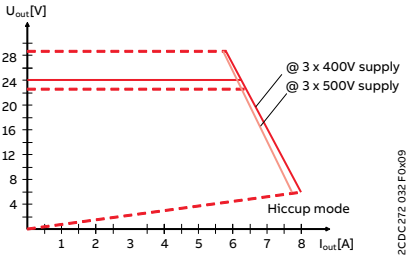

CP-T 24/5.0

2CDC272.032.F0x09

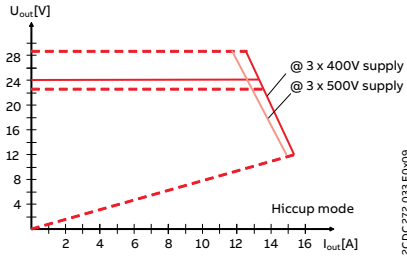

CP-T 24/10.0

2CDC272.033.F0x09

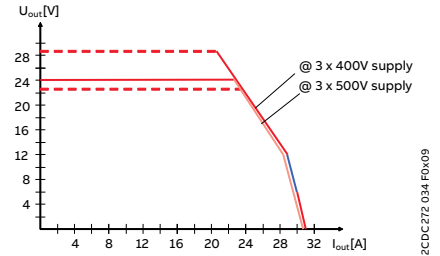

CP-T 24/20.0 U/I curve

2CDC272.034.F0x09

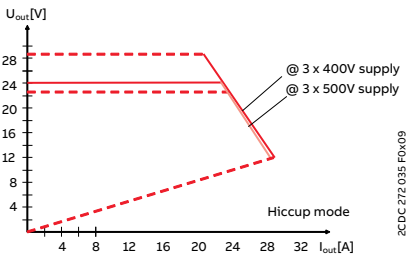

CP-T 24/20.0 Hiccup mode

2CDC272.035.F0x09

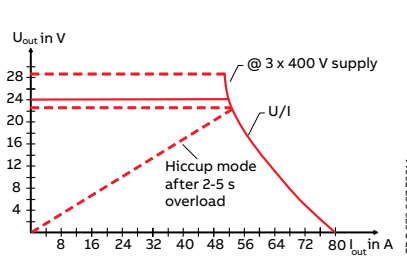

CP-T 24/40.0

2CDC272.027.F0211

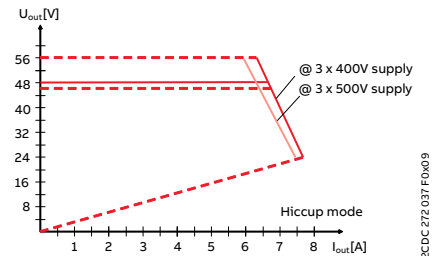

CP-T 48/5.0

2CDC272.037.F0x09

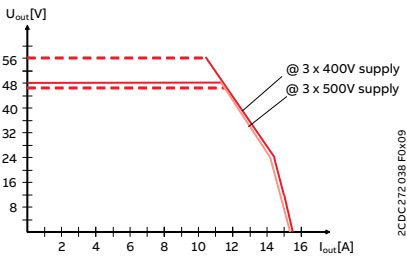

CP-T 48/10.0 U/I curve

2CDC272.038.F0x09

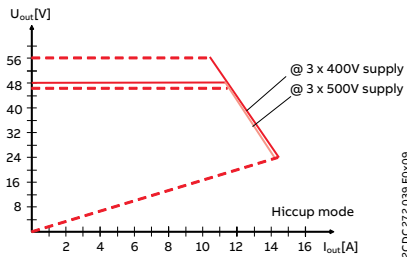

CP-T 48/10.0 Hiccup mode

2CDC272.039.F0x09

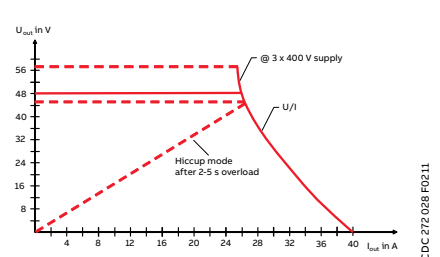

CP-T 48/20.0

2CDC272.038.F0211

### Temperature curves at rated load

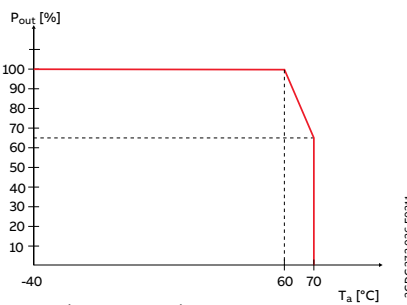

CP-T 24/40.0, CP-T 48/20.0

2CDC272.026.F0211

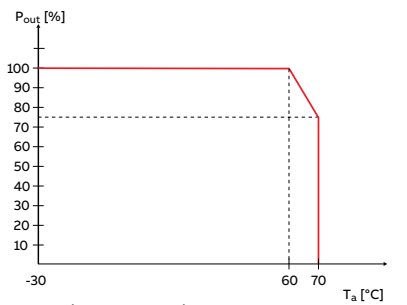

CP-T 24/20.0, CP-T 48/10.0

2CDC272.030.F0211

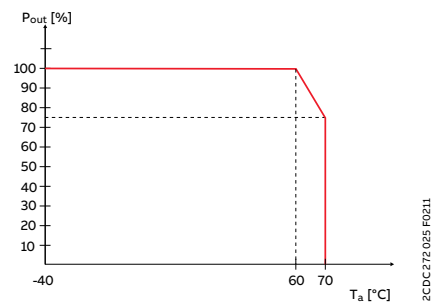

CP-T 24/5.0, CP-T 24/10.0, CP-T 48/5.0

2CDC272.025.F0211

# CP-T range

## Technical diagrams

### Dimensional drawings

Dimensions in mm and inches

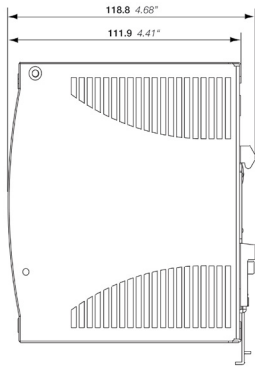

CP-T 24/5.0

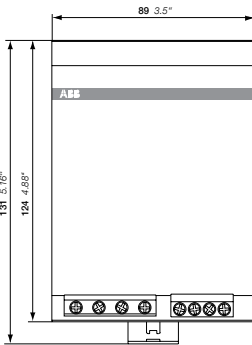
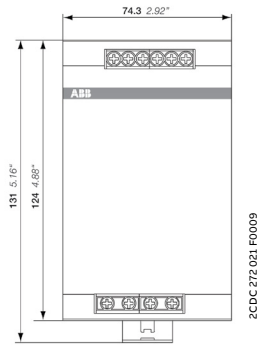

CP-T 24/10.0, CP-T 48/5.0

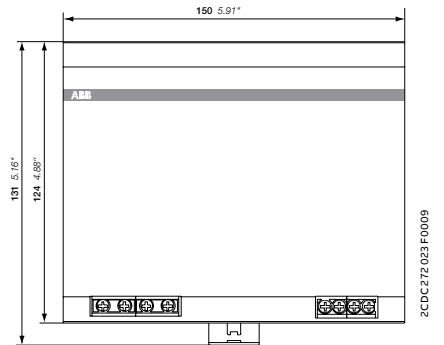

CP-T 24/20.0, CP-T 48/10.0

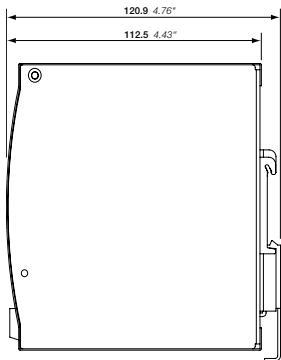

CP-T 24/40.0, CP-T 48/20.0

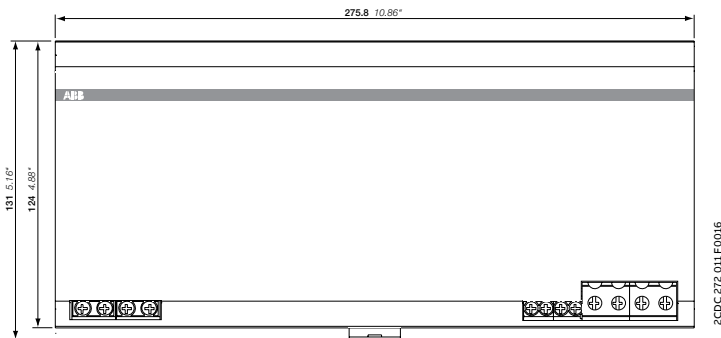

2CDC272 011 F0016

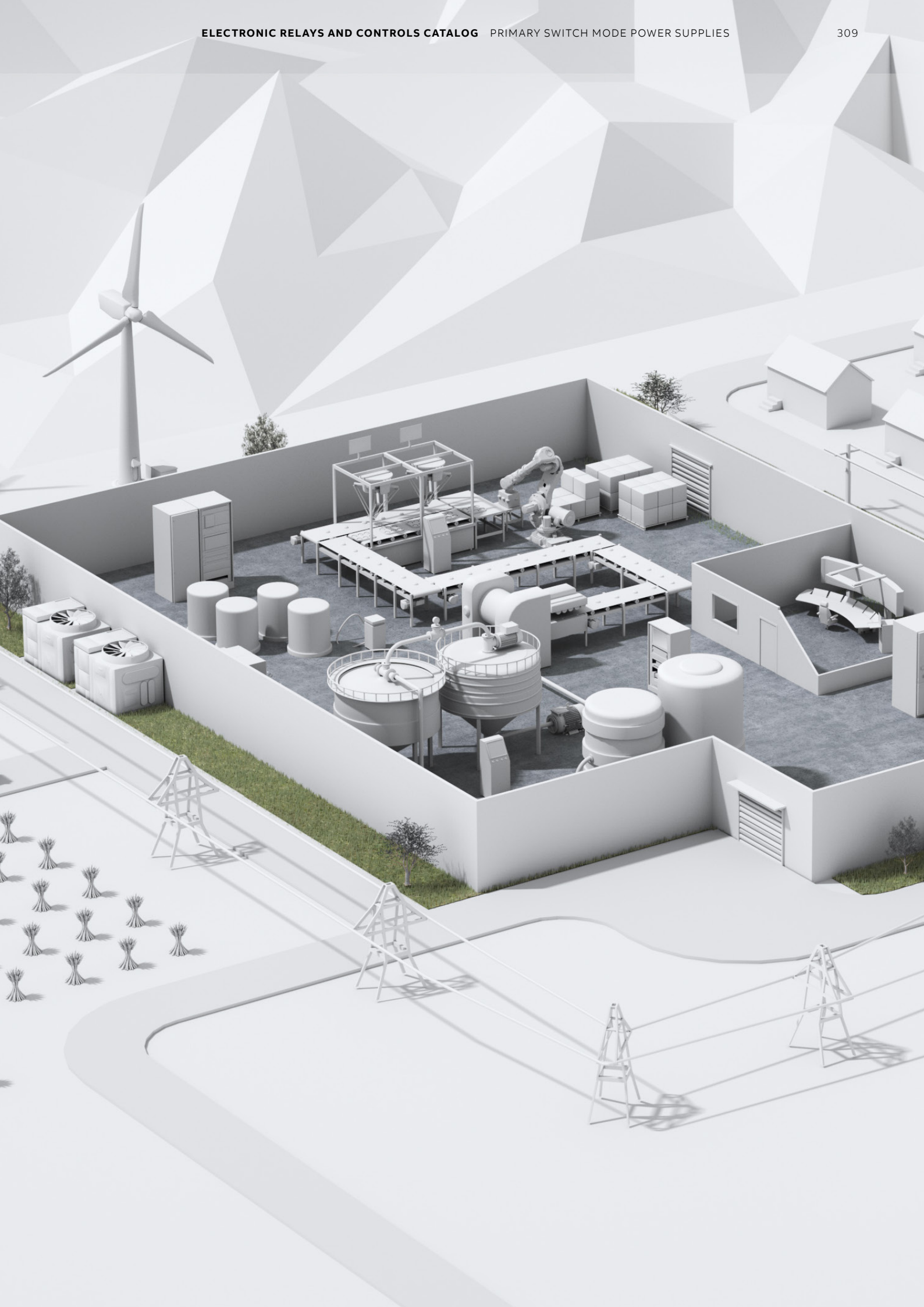



---

## **CP-S.1 range**

### Table of contents

<b>48</b>	<b>Benefits and advantages</b>
<b>50</b>	<b>Operating controls</b>
<b>52</b>	<b>Characteristics</b>
<b>54</b>	<b>Application example</b>
54	Softstarter and Safety
55	Food & beverage
<b>56</b>	<b>Ordering details</b>
<b>57</b>	<b>Technical data</b>
<b>61</b>	<b>Technical diagrams</b>



# CP-S.1 power supply range

## Benefits and advantages



CP-S.1 power supplies: high efficiency and reliability delivered in a compact footprint. Designed for a huge variety of applications, including machine building segments, this advanced range boosts an integrated 150 % power reserve for five seconds and operates at an efficiency of up to 94 %. With overheat protection, active power factor correction, a broad certified AC and DC input range and extensive worldwide approvals including marine, the all-new CP-S.1 power supplies are a preferred choice for multiple industrial applications.

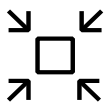

**Space saving**

### Outstanding power to space ratio

In comparison to other power supply ranges on the market, ABB's CP-S.1 range achieves space savings up to 50 %. Together with the high-efficiency and reduced power losses features, CP-S.1 is a space and cost saving solution for applications where size matters.



**Continuous operation**

### System reliability

The power reserve functionality provides additional power of starting heavy loads. CP-S.1 offers 150 % of the nominal current for five seconds to start e.g. heavy loads reliably. Together with ABB's redundancy modules CP-C.1-A-RU as well as buffer modules CP-B range - buffering the load in case of power losses on grid side - increase the availability and finally the system reliability further. Coated PCBA completes CP-S.1 range offering for OEM machine builders.



**Global availability**

### Global availability

CP-S.1 range can be used in multiple installations in the world. A certified wide AC and DC input voltage range as well as a variety of approvals incl. marine, giving you the confidence of world-wide sourcing – no matter where you build, install or operate your equipment.

# CP-S.1 power supply range

## CO<sub>2</sub> reduction



CP-S.1 power supplies operate at an astonishing efficiency of up to 94%. By increasing the efficiency by just 2 %, 1,4 tons of CO<sub>2</sub> can be saved over the lifetime of ten years of a 40 A power supply at nominal load. This corresponds to the CO<sub>2</sub> emissions of 167.000 numbers of smartphone charges.

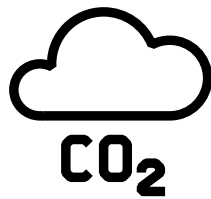

**1400**  
kilograms of CO<sub>2</sub>  
reduction over the  
lifetime

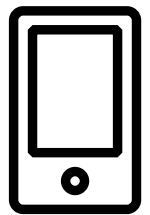

**>160,000**  
Smartphones  
charged



### Main benefits

#### Complete offering

A complete 24 V DC offering from 3 A up to 40 A in metal enclosure suits perfectly to OEM machine building requirements.

#### Small footprint

CP-S.1 power supplies can save the valuable installation space of the control cabinet due to compact design and high efficiency.

#### Robust design

Coated PCBA and marine certification enable CP-S.1 power supplies being the perfect match for e.g. Wind, Solar, Marine applications.

#### Redundancy units

True redundancy could be achieved by using the optional redundancy unit CP-C.1-A-RU.

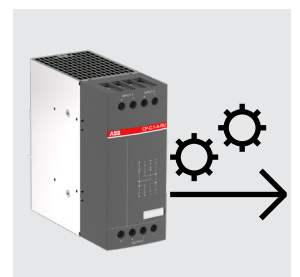

# CP-S.1 power supplies

## Operating controls

**OUTPUT L+, L-:**  
Output terminals  
24 V DC

**OUTPUT Adjust:**  
Rotary potentiometer - Adjustment of  
output voltage  
24-28 V DC

**Circuit diagram**

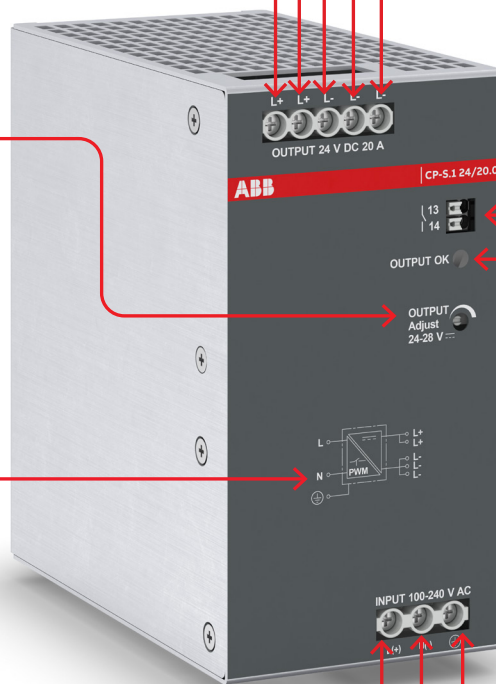

**Additional L(-)  
terminal for e.g.  
grounding**

**13-14: Relay output**  
Relay output to  
signal 'Output OK'

**OUTPUT OK: green  
LED for indication of  
24 V DC**

- on: output voltage  
>92% of adjusted  
voltage
- flashes: output  
voltage <90% of  
adjusted voltage

**INPUT L(+), N(-), PE\*:**  
Input terminals  
100 - 240 V AC /  
100 - 250 V DC



**CP-S.1 power supplies not only take up less space in the control cabinet, but also help reduce environmental impact.**





# CP-S.1 power supplies

## Characteristics



### Characteristics

- Rated supply voltage range from 100-240 V AC / 100-250 V DC
- Rated output voltage 24 V DC
- Rated output current of 3.0 A, 5.0 A, 10.0 A, 20.0 A and 40.0 A
- High efficiency of up to 94 %
- Power reserve design of 150 % for 5 s
- Output voltage adjustable via front-face rotary potentiometer "OUTPUT Adjust", 24-28 V
- Low power dissipation and low heating
- Free convection cooling (no forced cooling)
- Coated PCBAs
- Open-circuit, overload and short-circuit protection
- Integrated input fuse
- DC OK - signaling output "13-14" (relay)
- CP-C.1-A-RU redundancy unit offers true redundancy, available as accessory
- Various approvals and marks





Thanks to their small footprint and high efficiency, CP-S.1 power supplies are versatile and with their wide application range, they can be found everywhere, including the ones listed below.



**Robotics**



**Material handling**



**Packaging**



**EV charging**



**Food & Beverage**



**Genset/UPS**



**Marine**



**Renewables**

# CP-S.1 power supplies

## Application example Softstarter and Safety<sup>\*)</sup>

A sawmill or lumber mill is a facility where logs are processed into lumber. Modern sawmills use a motorized saw to cut logs lengthwise to make long pieces, and crosswise to determine length according to standard or custom sizes (dimension lumber). The "portable" sawmill is of simple operation. The log lies flat on a steel bed, and the motorized saw cuts the log horizontally along the length of the bed by the operator manually pushing the saw. The simplest type of sawmill consists of a chainsaw and a custom-made jig ("Alaskan sawmill"), with similar horizontal operation. Energy management is a point of great interest.

### Application example: Softstarter and Safety (SIL3/PLe, motor power/starting: <15 kW)

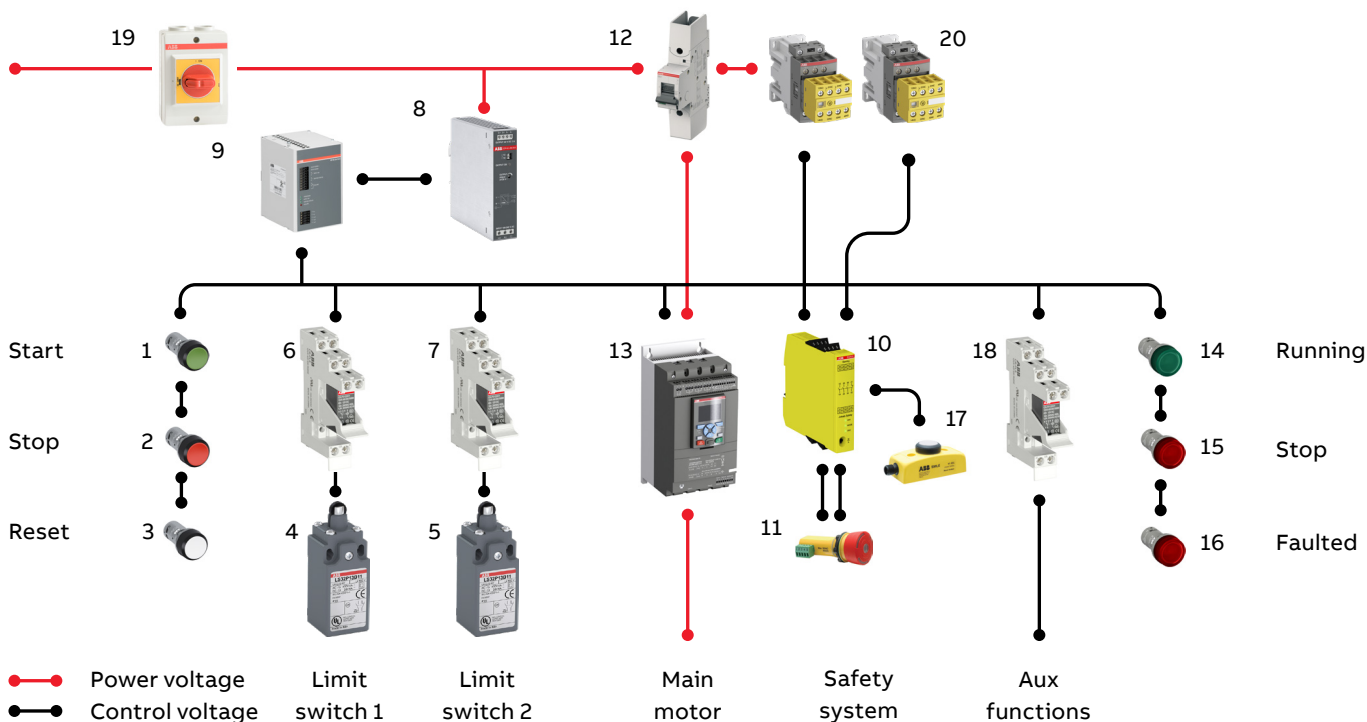

#	Order code	Description
1	1SFA619100R1012	Pushbutton CP1-10G-10
2	1SFA619100R1041	Pushbutton CP1-10R-01
3	1SFA619100R1015	Pushbutton CP1-10W-10
4	1SBV010510R1211	Limit switch 30 mm wide, 1 ISO M 16x1.5 cable entry on the bottom, plain plastic plunger actuator and 1 N.O. + 1 N.C. snap action (Zb type) contacts
5	1SBV010510R1211	Limit switch 30 mm wide, 1 ISO M 16x1.5 cable entry on the bottom, plain plastic plunger actuator and 1 N.O. + 1 N.C. snap action (Zb type) contacts
6	1SVR405600R1000	Pluggable interface relay CR-P024DC1 1c/o, A1-A2 = 24 V DC, 250 V/16 A with socket
7	1SVR405600R1000	Pluggable interface relay CR-P024DC1 1c/o, A1-A2 = 24 V DC, 250 V/16 A with socket
8	1SVR320661R1000	Power supply CP-S.1 24/10.0, In: 100-240 V AC, 100 - 250 V DC, Out: 24 V DC
9	1SVR427060R1000	Buffer module CP-B 24/10.0, 24 V DC / 10 A, energy storage 13.700 Ws
10	2TLA010050R0000	Sentry safety relay SSR10 24 V
11	2TLA030054R0100	Emergency stop INCA 1
12	2CCS861002R0064	High-performance miniature circuit breaker S801S-C6-R
13	1SFA898103R7000	Softstarter PSTX30-600-70
14	1SFA619403R5022	Pilot light CL2-502G 24 V AC/DC
15	1SFA619403R5021	Pilot light CL2-502R 24 V AC/DC
16	1SFA619403R5021	Pilot light CL2-502R 24 V AC/DC
17	2TLA030053R0000	Reset button Smile 11 RA
18	1SVR405600R1000	Pluggable interface relay CR-P024DC1 1 c/o, A1-A2 = 24 V DC, 250 V/16 A with socket
19	1SCA022399R6590	Safety switch OTP16KA3M
20	1SBL176082R3022	2x Contactor AFS16Z-30-22-30 24 V DC

<sup>\*)</sup> Disclaimer: This bill of material shows one possible combination of devices. It should not be used in real projects without taking technical and other guidelines into account. Please select the size of devices including power supplies according to the specific requirements of the application.

# CP-S.1 power supplies

## Application example food & beverage<sup>\*)</sup>

The term mixer refers to containers which are filled with liquids and / or solids and then rotate to mix the contents. Mixers are used extensively not only in the food and beverage sector but also in many other applications like chemicals and road construction. In many mixers, heating and/or cooling may also be required. Subjected to application requirements, mixer control systems are working independently or connected to PLCs /DCS. Safety and F&B standards are very important for mixers.

### Application example: Mixers (motor power/starting: 3 kW / direct-online starter (DOL))

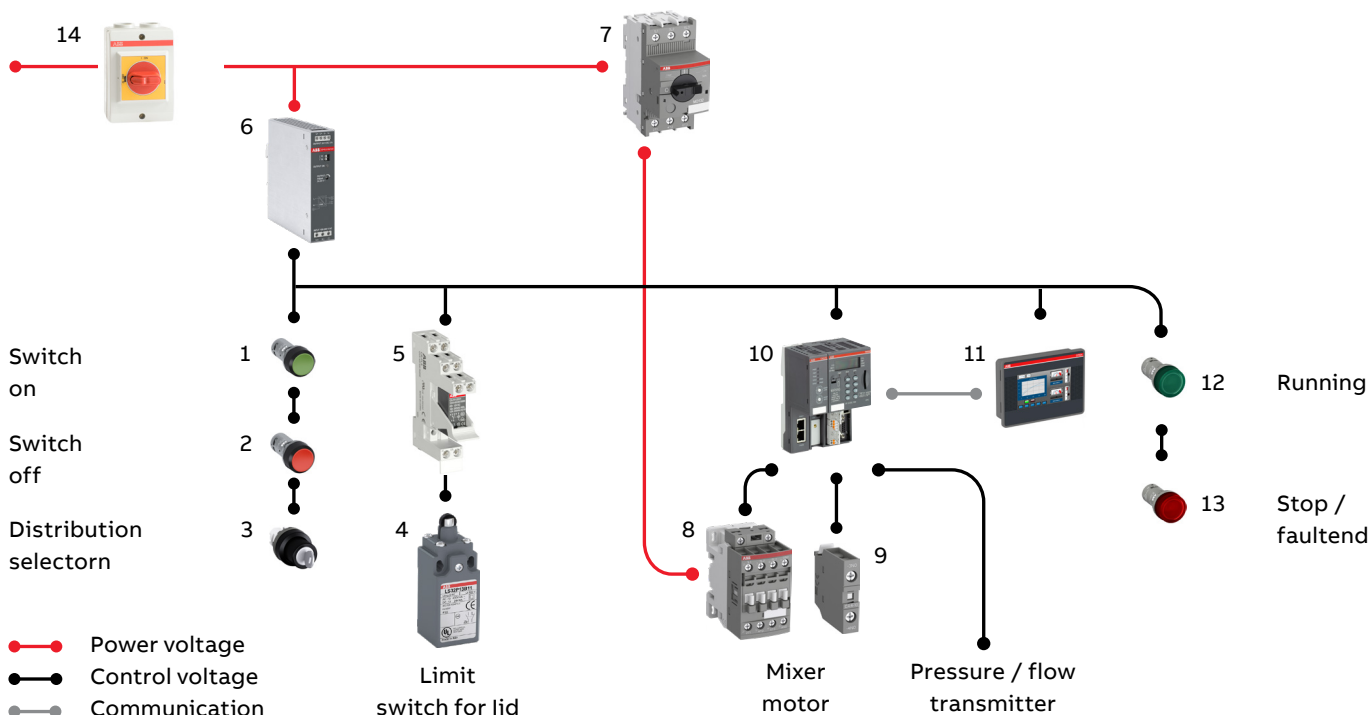

#	Order code	Description
1	1SFA619100R1012	Pushbutton CP1-10G-10
2	1SFA619100R1041	Pushbutton CP1-10R-01
3	1SFA611284R1001	Selector switch M3SSK2-101
4	1SBV010310R1211	30 mm wide, 1 ISO M16 x 1.5 cable entry on the bottom, plain plastic plunger actuator and 1 N.O + 1 N.C snap action (Zb type) contacts
5	1SVR405600R1000	Pluggable interface relay CR-P024DC1 1c/o, A1-A2=24 V DC, 250 V/16 A with socket
6	1SVR320361R1000	Power supply CP-S.1 24/10.0 In: 100-240 V AC Out: 24 V DC/10.0 A
7	1SAM350000R1010	Manual Motor Starter MS132-10
8	1SBL237001R1100	Contacteur AF26-30-00-11, 24-60 V 50/60 Hz 20-60 V DC
9	1SBN010110R1010	Auxiliary contact block CA4-10
10	1SAP111100R0270	Scalable PLC AC500, CPU PM592-ETH with PROFINET IO CM579-PNIO
11	1SAP504100R0001	CP604 Control Panel 4.3" TFT touch screen
12	1SFA619403R5022	Pilot light CL2-502G 24 V AC/DC
13	1SFA619403R5021	Pilot light CL2-502R 24 V AC/DC
14	1SCA022399R6590	Safety switch OTP16KA3M

<sup>\*)</sup> Disclaimer: This bill of material shows one possible combination of devices. It should not be used in real projects without taking technical and other guidelines into account. Please select the size of devices including power supplies according to the specific requirements of the application.



# CP-S.1 power supplies

## Ordering details



CP-S.1 24/3.0



CP-S.1 24/20.0



CP-C.1-A-RU

### Description

ABB's new generation of CP-S.1 power supplies for machine building applications deliver high efficiency, high reliability and a minimized footprint. This advanced range of power supplies has an integrated 150 % power reserve functionality for up to 5 s and operate at an efficiency of up to 94 %. They come equipped with overheat protection and active power factor correction\*, combined with a broad AC and DC input voltage range and extensive worldwide approvals. Make the all-new CP-S.1 power supplies your preferred choice for professional DC applications. UL listing as well as marine approvals complete the assortment offering.

CP-S.1 power supplies have a rated output voltage of 24 V DC that is adjustable via a front-face rotary potentiometer "OUTPUT Adjust". The power supplies are available with rated output currents of 3.0 A, 5.0 A, 10 A, 20 A and 40 A. The rated output power ranges from 72 - 960 W and the rated supply voltage range from 100-240 V AC / 100-250 V DC. The typical efficiency is up to 94 % with low power dissipation and low heating. CP-S.1 power supplies have free convection cooling (no forced cooling with ventilators) and operate at an ambient temperature range from -25...+60 °C without derating (+70 °C with derating). They feature an open-circuit and are overload and short-circuit stable as well as an integrated input fuse.

Additionally, true redundancy for critical applications can be achieved with the optional redundancy units CP-C.1-A-RU which is available as an accessory. One LED on the front of the power supplies indicates the status and a transistor DC OK - signalling output "13-14".

### Ordering details

Description	Rated input voltage	Rated output voltage	Rated output current	Output power	Order code
CP-S.1 24/3.0	100-240 V AC, 100-250 V DC	24 V DC	3.0 A	72 W	1SVR320361R1000
CP-S.1 24/5.0			5.0 A	120 W	1SVR320561R1000
CP-S.1 24/10.0			10.0 A	240 W	1SVR320661R1000
CP-S.1 24/20.0			20.0 A	480 W	1SVR320761R1000
CP-S.1 24/40.0			40.0 A	960 W	1SVR320861R1000
CP-C.1-A-RU	10 - 56 V DC	12 - 48 V DC	2 x 20 A or 1 x 40 A	-	1SVR360060R1001

\*) Not equipped with 72 W variant (3A).

\*) Not equipped with 72 W variant (3A).

## CP-S.1 power supplies

### Technical data

Data at  $T_a = 25\text{ °C}$  and rated values ( $U_{in} = 230\text{ V AC}$ ), unless otherwise indicated

Type		CP-S.1 24/3.0	CP-S.1 24/5.0	CP-S.1 24/10.0	CP-S.1 24/20.0	CP-S.1 24/40.0	
<b>Input circuit - Supply circuit (L(+), N(-))</b>							
Rated input voltage $U_{in}$		100 - 240 V AC, 100 - 250 V DC				110 - 240 V AC, 110 - 250 V DC	
Input voltage range		85 - 264 V AC / 90 - 277 V DC				99 - 264 V AC / 99 - 277 V DC	
Input current range at rated output power	100 - 240 V AC	0.95 - 1.46 A	0.67 - 1.45 A	1.25 - 2.8 A	2.55 - 5.8 A	5.0 - 11.5 A	
	100 - 250 V DC	0.35 - 1.0 A	0.58 - 1.63 A	1.12 - 3.15 A	2.28 - 6.4 A	4.48 - 13.5 A	
Typical input current	at 115 V AC	1.52 A	1.24 A	2.45 A	4.85 A	9.5 A	
	at 230 V AC	0.95 A	0.67 A	1.25 A	2.55 A	5.0 A	
Max. power consumption	at 230 V AC	82 W	132 W	258 W	517 W	1,022 W	
Rated frequency		DC, 50 / 60 Hz					
Frequency range	AC	45 - 65 Hz					
Inrush current limiting, cold state		$\leq 11\text{ A}$	$\leq 11\text{ A}$	$\leq 11\text{ A}$	$\leq 12.8\text{ A}$	$\leq 19\text{ A}$	
Let-through energy $I^2t$ , cold state	at 230 V AC	$< 1.5\text{ A}^2\text{s}$	$< 1.2\text{ A}^2\text{s}$	$< 1.7\text{ A}^2\text{s}$	$< 3\text{ A}^2\text{s}$	$< 5\text{ A}^2\text{s}$	
Discharge current towards PE		$< 3.5\text{ mA}$					
Hold-up time	at 115 V AC	$> 10\text{ ms}$	$> 20\text{ ms}$	$> 15\text{ ms}$	$> 15\text{ ms}$	$> 20\text{ ms}$	
	at 230 V AC	$> 20\text{ ms}$	$> 30\text{ ms}$	$> 20\text{ ms}$	$> 20\text{ ms}$	$> 20\text{ ms}$	
Internal input fuse		Yes					
Recommended backup fuse for wire protection at $1.5\text{ mm}^2$		1 pole miniature circuit breaker ABB type S 200 (for USA/CAN: use appropriate branch circuit 20 A fuse acc. to regional and national regulation)					
	characteristic	B or C					
	max. rating	16 A					
Power Factor Correction (PFC)		no	yes, active				
Transient over-voltage protection		yes, varistor					
<b>User interface - Indication of operational states</b>							
Output voltage	LED ,OUTPUT OK'	Green	$\geq 92\%$ of adjusted $U_{out}$				
	LED ,OUTPUT OK'	Flash	$< 90\%$ of adjusted $U_{out}$				
<b>Output circuits - power output (L+, L-)</b>							
Rated output voltage		24 V DC					
Tolerance of the output voltage		$\pm 1\%$					
Adjustment range of the output voltage		24...28 V DC					
Rated output power		72 W	120 W	240 W	480 W	960 W	
Rated output current $I_r$	$-25\text{ °C} \leq T_a \leq 60\text{ °C}$	3 A	5 A	10 A	20 A	-	
	$-25\text{ °C} \leq T_a \leq 55\text{ °C}$	-	-	-	-	40 A	
Power reserve current	$-25\text{ °C} \leq T_a \leq 60\text{ °C}$	4.5 A (5 s)	7.5 A (5 s)	15 A (5 s)	30 A (5 s)	60 A (5 s) / $-25\text{ °C} \leq T_a \leq 55\text{ °C}$	
Short-circuit current limiting		$< 5.2\text{ A}$	$< 8.62\text{ A}$	$< 17.25\text{ A}$	$< 34.5\text{ A}$	$< 70\text{ A}$	
Derating of the output current	$60\text{ °C} \leq T_a \leq 70\text{ °C}$	2.5 % / K				-	
	$55\text{ °C} \leq T_a \leq 70\text{ °C}$	-				2 % / K	
Deviation width of output voltage	Load effect/ load regulation	static load change: 25 - 100 %	$< 1\%$	$< 1\%$	$< 1\%$	$< 1\%$	
		Transient response of voltage to load current changes	recovery time $T_R$	$< 1\text{ ms}$	$< 1\text{ ms}$	$< 1\text{ ms}$	$< 1\text{ ms}$
	Change of input voltage	within the rated input voltage	$< 0.5\%$	$< 0.5\%$	$< 0.5\%$	$< 0.5\%$	$< 0.5\%$
			$< 0.5\%$	$< 0.5\%$	$< 0.5\%$	$< 0.5\%$	$< 0.5\%$
Starting time after applying the supply voltage		$< 1,500\text{ ms}$	$< 1,500\text{ ms}$	$< 1,500\text{ ms}$	$< 1,500\text{ ms}$	$< 1,500\text{ ms}$	
Residual ripple and switching peaks	BW = 20 MHz	$< 75\text{ mV}_{pp}$ , class A					
Parallel connection		yes, up to 3					
Series connection		yes, 2					



## CP-S.1 power supplies

### Technical data

Type	CP-S.1 24/3.0	CP-S.1 24/5.0	CP-S.1 24/10.0	CP-S.1 24/20.0	CP-S.1 24/40.0	
<b>No-load, overload and short-circuit behavior</b>						
Characteristic curve of output	U/I characteristic curve			U/I characteristic curve combined with foldback behavior		
Short-circuit protection	continuous short-circuit stability					
Short-circuit behavior	current limiting					
Resistance to reverse feed	≤ 35 V DC					
Overvoltage protection	yes, < 35 V					
Overload protection	constant current limitation					
Overtemperature protection	protection by switch off in case of overtemperature (thermal)					
No-load protection	continuous no-load stability					
Starting of capacitive loads	Yes					
<b>Signaling outputs - OUTPUT OK signaling output</b>						
Type of output	13 - 14	relay, n/o contact				
ON (contact closed)		≥ 92 % of adjusted U <sub>out</sub>				
OFF (contact open)		< 90 % of adjusted U <sub>out</sub>				
Contact ratings	max. switching voltage / current	30 V AC - 0.5 A / 24 V DC - 1 A (resistive load)				
	min. switching voltage / current	5 V DC / 1 mA				
<b>General data</b>						
Efficiency	at rated load	> 89 %	> 90 %	> 93 %	> 93 %	> 94 %
Power losses	at rated load	< 10 W	< 12 W	< 18 W	< 37 W	< 62 W
	at 50 % of rated load	< 6.5 W	< 9.5 W	< 14 W	< 24 W	< 45 W
	at no load	< 2.8 W	< 3.5 W	< 5 W	< 6 W	< 6.5 W
Duty time		100 %				
MTBF	acc. to MIL 217 HDBK GB 25	on request				
Dimensions (W x H x D)		see dimensional drawings				
Material of housing	cover	zinc-coated sheet-steel				
	housing shell	aluminium				
	front	plastic, PC GE8B35, V0				
Mounting		DIN rail (IEC/EN 60715), snap-on mounting				
Mounting position		position 1 (standard orientation); other mounting positions possible with derating / deratings are available on demand				
Minimum distance to other units	horizontal	30 mm				
	vertical	50 mm				
Degree of protection (IEC/EN 60529)	housing / terminals	IP20 / IP20				
Protection class (IEC/EN 61140)		I				
<b>Electrical connection</b>						
Connecting capacity	rigid	0.5-2.5 mm <sup>2</sup> (20-14 AWG)	0.5-4.0 mm <sup>2</sup> (20-12 AWG)	0.5-4.0 mm <sup>2</sup> (20-12 AWG)	0.5-4.0 mm <sup>2</sup> (20-12 AWG)	0.5-10.0 mm <sup>2</sup> (20-8 AWG)
	fine-strand with(out) wire end ferrule	0.5-2.5 mm <sup>2</sup> (26-14 AWG)	0.5-4.0 mm <sup>2</sup> (20-12 AWG)	0.5-4.0 mm <sup>2</sup> (20-12 AWG)	0.5-4.0 mm <sup>2</sup> (20-12 AWG)	0.5-10.0 mm <sup>2</sup> (20-8 AWG)
Stripping length		9 mm	9 mm	9 mm	9 mm	10 mm
Tightening torque		0.5 Nm 4.43 lb.in	0.5 Nm 4.43 lb.in	0.5 Nm 4.43 lb.in	0.5 Nm 4.43 lb.in	1.47 Nm 13.0 lb.in
Recommended screw driver		PH0 / Ø 3.5 x 0.6 mm	PH1 / Ø 4.0 x 0.8 mm	PH1 / Ø 4.0 x 0.8 mm	PH1 / Ø 4.0 x 0.8 mm	PH2 / Ø 5.5 x 1.0 mm

## CP-S.1 power supplies

### Technical data

Type	CP-S.1 24/3.0	CP-S.1 24/5.0	CP-S.1 24/10.0	CP-S.1 24/20.0	CP-S.1 24/40.0
<b>Output circuits (L+, L+, L-, L-)</b>					
Stripping length	9 mm	9 mm	9 mm	9 mm	10 mm
Tightening torque	0.5 Nm 4.43 lb.in	1.13 Nm 10 lb.in	1.13 Nm 10 lb.in	1.13 Nm 10 lb.in	1.47 Nm 13.0 lb.in
Recommended screw driver	PH0 / Ø 3.5 x 0.6 mm	PH1 / Ø 4.0 x 0.8 mm	PH1 / Ø 4.0 x 0.8 mm	PH1 / Ø 4.0 x 0.8 mm	PH2 / Ø 5.5 x 1.0 mm
<b>Signalling output (13-14)</b>					
Connecting capacity	rigid	0.15 - 0.8 mm <sup>2</sup> (26 - 18 AWG)			
	fine-strand with(out) wire end ferrule	0.15 - 0.8 mm <sup>2</sup> (26 - 18 AWG)			
Stripping length	7 mm				
Connection terminals	push-in				
<b>Environmental data</b>					
Ambient temperature range	operation	-25...+70 °C (-13... +158 °F)			
	rated output power	-25...+60 °C (-13... +140 °F)			-25...+55 °C (-13... +131 °F)
	storage	-40...+85 °C (-40... +185 °F)			
	transportation	-40...+85 °C (-40... +185 °F)			
Climatic class (IEC/EN 60721-3-1)	storage	1K2			
Climatic class (IEC/EN 60721-3-2)	transportation	2K2			
Climatic class (IEC/EN 60721-3-3)	operation	3K3			
Damp heat, cyclic (IEC/EN 60068-2-30)	test Db: 55 °C, 2 cycles				
Vibration (IEC/EN 60068-2-6)	test Fc: 10-58 Hz, amplitude ±0.15 mm, 58-150 Hz, 2 g, 10 sweep cycles each axis				
Shock, half-sine (IEC/EN 60068-2-27)	test Ea: 30 g, 6 ms, 3 pulses each axis; bump 20 g, 11 ms, 100 pulses each axis				
Location classes (according DNV)	temperature: B / humidity: B / vibration: A / enclosure: A				
Coated PCBA	yes				
<b>Isolation data</b>					
Rated impulse withstand voltage U <sub>imp</sub> (IEC/EN 62477-1)	input circuit / output circuit	4 kV (1.2/50 µs)			
	input circuit / PE	4 kV (1.2/50 µs)			
	input circuit / relay contact	4 kV (1.2/50 µs)			
	output circuit / relay contact	0.8 kV (1.2/50 µs)			
	relay contact / PE	0.8 kV (1.2/50 µs)			
	output circuit / PE	0.8 kV (1.2/50 µs)			
Rated insulation voltage U <sub>i</sub> (IEC/EN 62477-1)	input circuit / output circuit	300 V			
	input circuit / PE	300 V			
	input circuit / relay contact	300 V			
	output circuit / relay contact	50 V			
	relay contact / PE	50 V			
	output circuit / PE	50 V			
Overvoltage category (IEC/EN 62477-1)	< 2000 m	III			
	2000...5000 m	II			
Overvoltage category (IEC/EN 61010-1/IEC/ EN 61010-2-201)	< 2000 m	II			
	2000 ...5000 m	II			
Pollution degree	2				
Protective separation IEC/EN 61010-1, 61010-2-201	input circuit / output circuit	yes			
	input circuit / relay output	yes			

## CP-S.1 power supplies

### Technical data

Type	CP-S.1 24/3.0	CP-S.1 24/5.0	CP-S.1 24/10.0	CP-S.1 24/20.0	CP-S.1 24/40.0
<b>Standards / Directives</b>					
Low Voltage Directive	2014/35/EU, IEC/EN 61204				
EMC directive	2014/30/EU				
RoHS directive	2011/65/EU incl. 2015/863/EU				
WEEE directive	2012/19/EU				
Electrical safety	IEC/EN 61010-1, IEC/EN 61010-2-201				
Process control equipment	UL 61010-1, UL 61010-2-201/ CAN/CSA C22.2 No. 61010-1-12, CAN/CSA-IEC 61010-2-201:18				
Protective extra low voltage	PELV_IEC/EN 61010-2-201				
Safety extra low voltage	SELV_IEC/EN 61010-2-201				
Limitation of harmonic line currents	IEC/EN 61010-2-201				
<b>Electromagnetic compatibility</b>					
Low-voltage power supplies, d.c. output – Part 3: Electromagnetic compatibility (EMC)	IEC/EN 61204-3				
Interference immunity to	IEC/EN 61000-6-2				
electrostatic discharge (ESD)	IEC/EN 61000-4-2	contact discharge air discharge, level 4, 8 kV / 15 kV (criterion A)			
radiated, radio-frequency, electromagnetic field	IEC/EN 61000-4-3	80 to 1000 MHz, 10 V/m (criterion A), 1.4 to 6 GHz, 3 V/m (criterion A)			
electrical fast transient / burst	IEC/EN 61000-4-4	level 4, 4 kV / 2 kV (criterion A)			
surge	IEC/EN 61000-4-5	level 4, L/N 3 kV (criterion A); level 4, L, N / PE 4 kV (criterion A)			
conducted disturbances, induced by radio-frequency fields	IEC/EN 61000-4-6	level 3, 10 V (criterion A)			
voltage dips, short interruptions and voltage variations	IEC/EN 61000-4-11	class 3			
harmonics and interharmonics	IEC/EN 61000-4-13	class 3 (criterion A)			
conducted, common mode disturbances in the frequency range 0 Hz to 150 kHz	IEC/EN 61000-4-1	level 3, 10 V			
Interference emission	IEC/EN 61000-6-3; IEC/EN 61000-6-4				
limits for harmonic current emissions	IEC/EN 61000-3-2	class A			
limitation of voltage changes etc.	IEC/EN 61000-3-3	compliant			
Electromagnetic compatibility of multimedia equipment - Emission requirements	IEC/CISPR 32, EN 55032	class B			
industrial scientific and medical (ISM) radio-frequency equipment electromagnetic disturbance characteristics limits and methods of measurement	EC/CISPR 11, EN 55011 EN 50204	class B			
Voltage sags	SEMI F47-0706	passed			
Federal Communications Commission	FCC15	compliant			
EMC according DNV	DNV-CG-0339	all locations including bridge and open deck class B			
Weight	550 g	690 g	830 g	1.355 g	2.490 g

# CP-S.1 power supplies

## Technical diagrams

### Wiring instructions

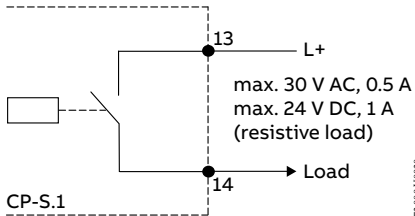

OUTPUT OK, relay output  
Rated voltage limits of the signaling output relay:  
Acc. UL 61010-1: 30 V RMS, 42.4 V peak, 60 V DC

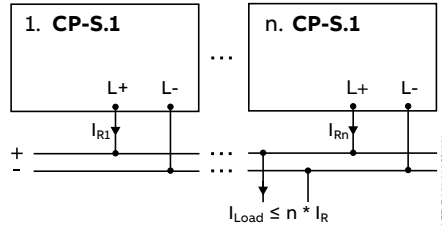

Parallel operation, increased power ( $n \leq 3$ )

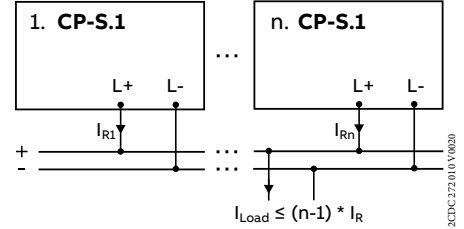

Parallel operation, redundancy ( $n \leq 3$ )

### U/I characteristic curves of output at $T_a = 25^\circ\text{C}$

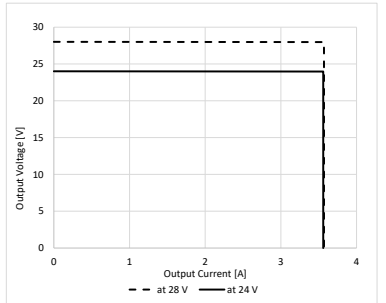

CP-S.1 24/3.0

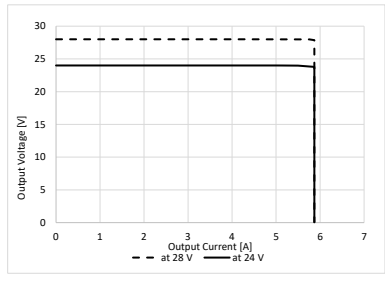

CP-S.1 24/5.0

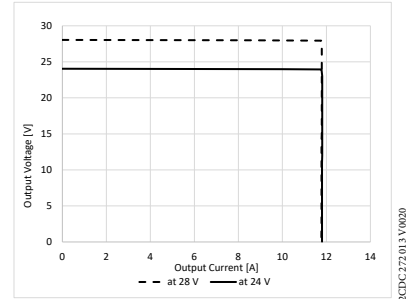

CP-S.1 24/10.0

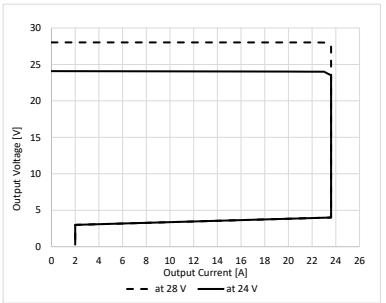

CP-S.1 24/20.0

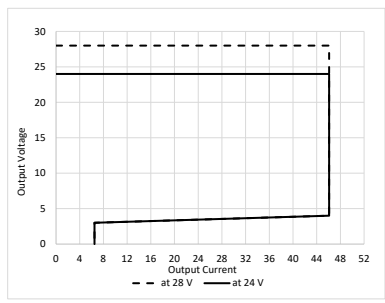

CP-S.1 24/40.0

# CP-S.1 power supplies

## Technical diagrams

### Mounting and dismounting

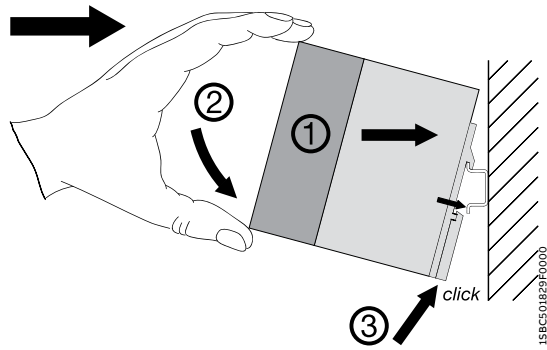

Mounting

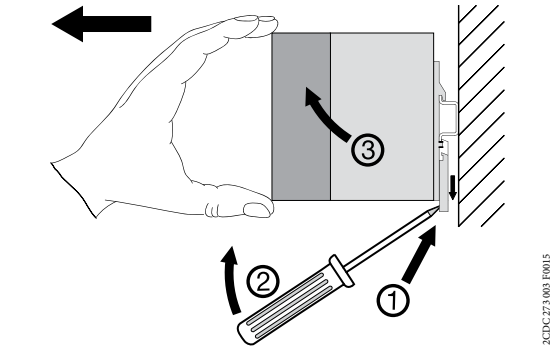

Dismounting

### Characteristic curves of temperature $U_{out} = 24\text{ V DC}$

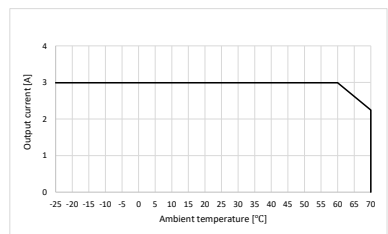

CP-S.1 24/3.0

2CDC272016 V0020

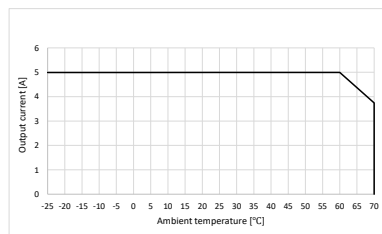

CP-S.1 24/5.0

2CDC272017 V0020

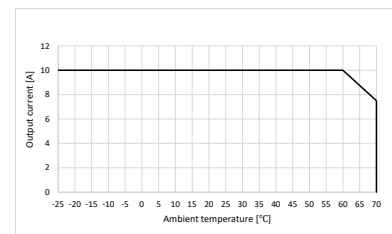

CP-S.1 24/10.0

2CDC272018 V0020

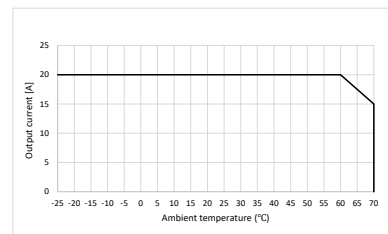

CP-S.1 24/20.0

2CDC272019 V0020

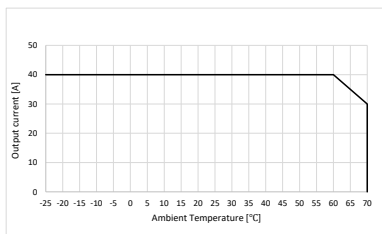

CP-S.1 24/40.0

2CDC272020 V0020



# CP-S.1 power supplies

## Technical diagrams

### Dimensional drawings in mm and inches

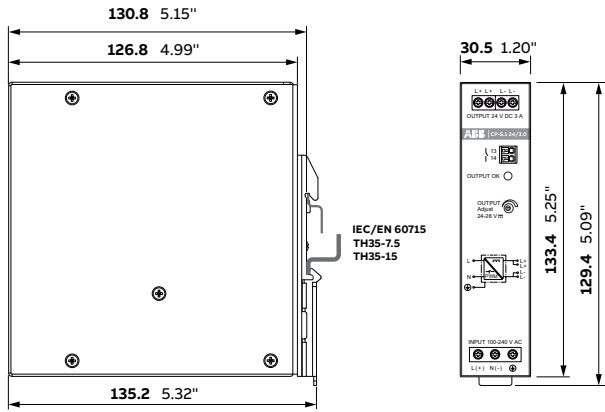

CP-S.124/3.0

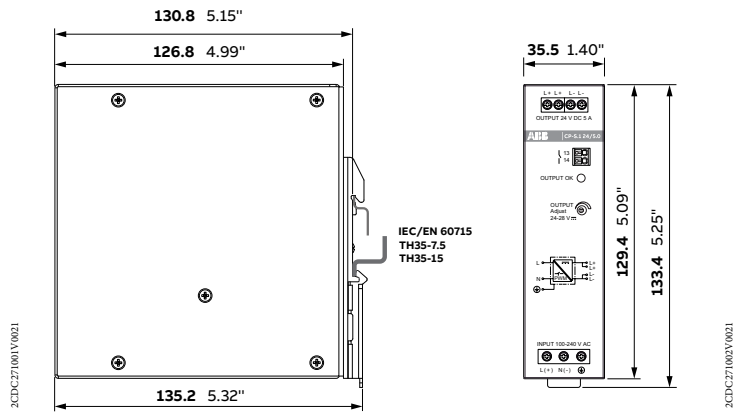

CP-S.124/5.0

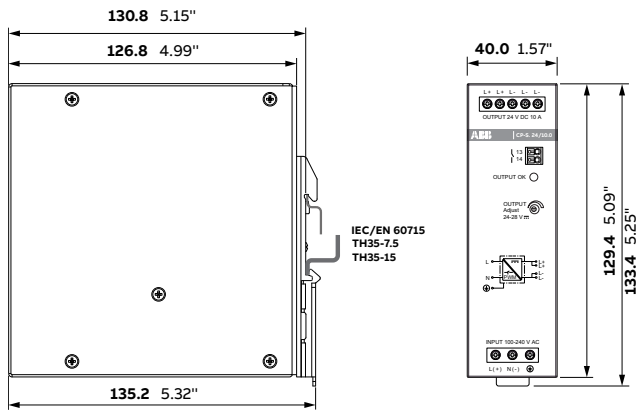

CP-S.124/10.0

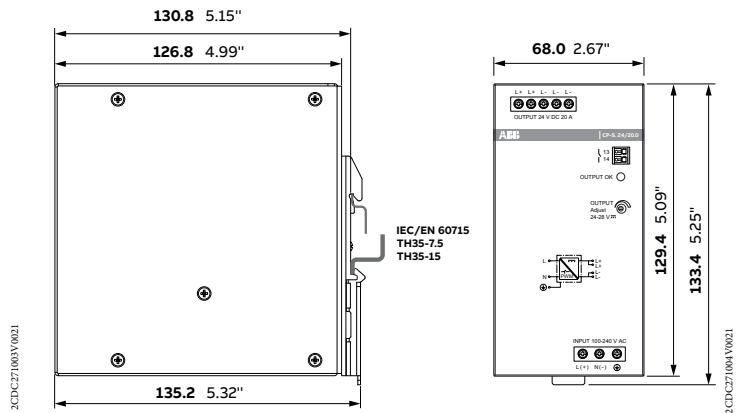

CP-S.124/20.0

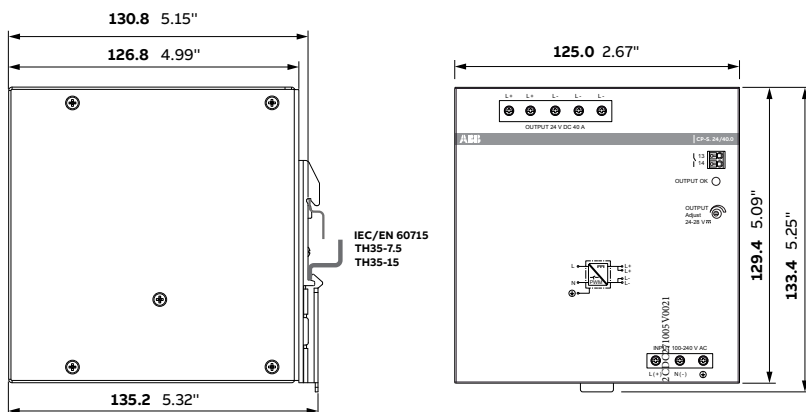

CP-S.124/40.0



---

## **CP-C.1 range**

### Table of contents

<b>66</b>	<b>Benefits and advantages</b>
<b>68</b>	<b>Operating controls</b>
<b>69</b>	<b>Applications</b>
<b>70</b>	<b>Ordering details</b>
<b>71</b>	<b>Technical data</b>
<b>83</b>	<b>Technical diagrams</b>

## CP-C.1 range

### Benefits and advantages



The high-performance CP-C.1 power supplies are ABB's most advanced range. With excellent efficiency, high reliability and innovative functionality, it is ready to take on the most demanding of industrial applications. These power supplies have a 150 % integrated power reserve, operate at an efficiency of up to 94 % and are equipped with overheat protection and active power factor correction. Combined with a broad AC and DC input range and extensive worldwide approvals, CP-C.1 power supplies are the preferred choice for professional DC applications. ATEX and IECEx approvals are available for the use in hazardous areas.



#### Continuous operation

- Power reserve design to allow performance with up to 150 % more current
- Redundancy setup of the application possible to allow parallel operation
- Long lifetime
- High peak currents for switching on capacitive loads are supported



#### Project cost reduction

- Up to 94 % efficiency saves money for energy during operation
- Less need for external cooling in the cabinet
- Small size to reduce space needed in panel



#### Reliable in harsh conditions

- Extended ambient temperature range during operation -40...+70 °C with coated PCBA version
- IECEx/ATEX approvals for hazardous locations available
- High MTBF values

# CP-C.1 range

## Benefits and advantages



### Characteristics

- Rated output voltage 24 V DC
- Power reserve design delivers up to 150 % at  $T_a \leq 40 \text{ }^\circ\text{C}$
- Output voltage adjustable via front-facing rotary potentiometer "OUTPUT Adjust", 22.5-28.5 V
- High efficiency of up to 94 %
- Low power dissipation and low heating
- Free convection cooling (no forced cooling)
- Devices with coated PCBAs for harsh environments and with extended temperature range
- Open-circuit, overload and short-circuit stable
- Integrated input fuse
- OUTPUT OK - signaling output "13-14" (relay), Power reserve signaling output " $I > I_r$ " (transistor)
- Redundancy unit offers true redundancy, available as accessory
- Various approvals and marks



### Main benefits

The primary switch mode power supply CP-C.1 has a wide range of certified AC and DC input voltages. Furthermore, the CP-C.1 is equipped with capacitors that ensure a hold-up time of at least 50 ms. This enables worldwide usage and permits safe operation in fluctuating networks and battery-powered applications.

With their robust metallic housing and the reliable construction, CP-C.1 power supplies are suitable for applications in industrial environments. The CP-C.1-C units have coated PCBAs, which enables their use in harsh industrial environments. The power reserve of up to 150 % enables trouble-free starting of heavy loads eliminating the need for an oversized power supply.

### Signaling output

To communicate the status of the power supply, the CP-C.1 is equipped with a relay output to signal OUTPUT OK as well as a transistor output  $I > I_r$  to indicate when the power reserve is active. These signals can be used for communication with a higher level control system, e.g. a PLC.

Depending on the logic of the higher level control system, an appropriate action is initiated by forwarding the signal. The receptor of this signal could be a contactor, a signal tower, or an interface relay.



# CP-C.1 range

## Operating controls

13-14: Relay output to signal 'Output OK'

$I > I_R$ : Power reserve transistor output to signal 'Power reserve is active'

OUTPUT L+, L-: Output terminals 24 V DC

Side mounting screw holes for DIN rail adapter / lateral mounting

Indication of operational states  
OUTPUT OK: Green LED  
POWER RESERVE  $I > I_R$ : Yellow LED

Circuit diagram

OUTPUT Adjust: Rotary potentiometer - Adjustment of output voltage 22.5-28.5 V DC

INPUT L(+), N(-), PE: Input terminals 85-264 V AC / 90 - 300 V DC

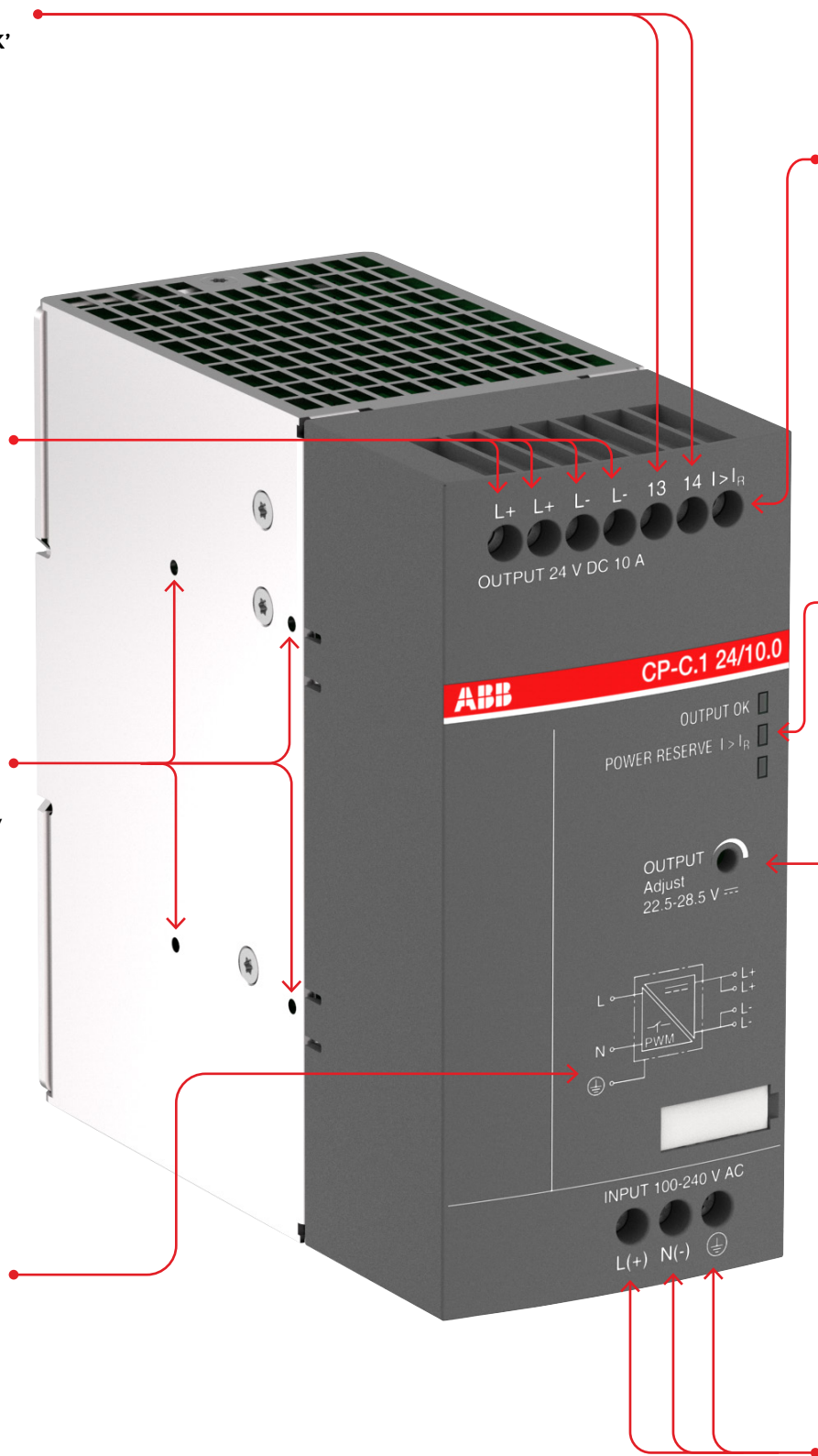

# CP-C.1 range

## Applications



### Application

The primary switch mode power supply CP-C.1 has a wide range of AC and DC input voltages. Furthermore, the CP-C.1 is equipped with capacitors that ensure a hold-up time of at least 50 ms. This enables worldwide usage and permits safe operation in fluctuating networks and battery-powered applications. With their robust metallic housing and reliable construction, CP-C.1 power supplies are suitable for applications in industrial environments. The CP-C.1-C units have coated PCBAs, which enables their use in the harshest of industrial environments. usage in even harsh industrial environments. The power reserve of up to 150 % enables trouble-free starting of heavy loads eliminating the need for an oversized power supply.



### Adjustable output voltage

The CP-C.1 range power supplies feature a continuously adjustable output voltage of 22.5 to 28.5 V DC. Thus, they can be optimally adapted to the applications, e.g. compensating the voltage drop caused by a long line length.



### Signaling output

To communicate the status of the power supply, the CP-C.1 is equipped with a relay output to signal OUTPUT OK as well as a transistor output  $I > I_R$  to indicate when the power reserve is active. These signals can be used for communication with a higher level control system, e.g. a PLC.



### Power reserve

The primary switch mode power supply CP-C.1 is equipped with a power reserve functionality to handle the start-up of particularly heavy loads (e.g. of a capacitive load or a motor). To ensure that heavy loads are started up, the CP-C.1 delivers additionally up to 150 % of the rated output current to secure the operation of the application. This status is displayed by the yellow LED labelled POWER RESERVE  $I > I_R$ .

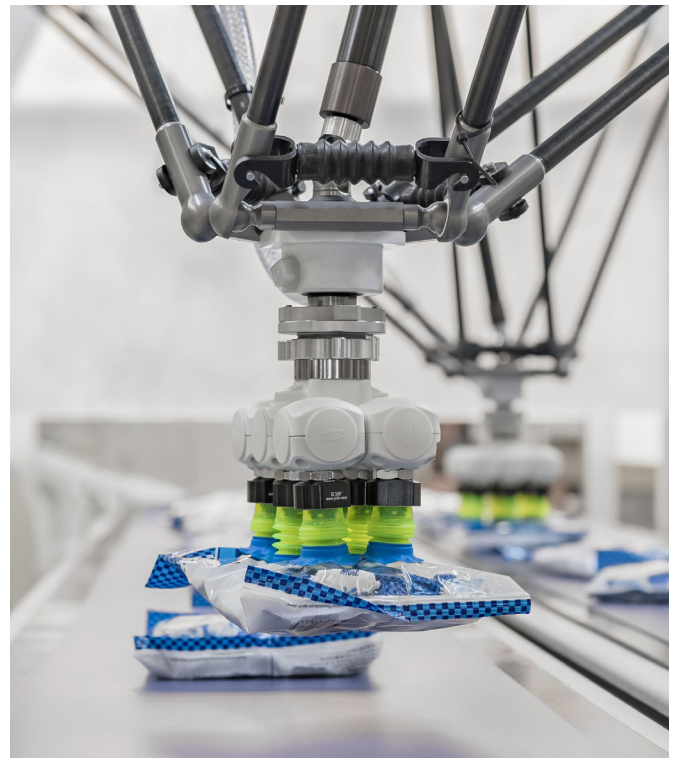

# CP-C.1 range

## Ordering details



CP-C.1 24/5.0  
CP-C.1 24/5.0-C

2CDC271009 F007



CP-C.1 24/10.0  
CP-C.1 24/10.0-C

2CDC271010 V007



CP-C.1 24/20.0  
CP-C.1 24/20.0-C

2CDC271011 V007



CP-C.1 24/5.0-L



CP-C.1 24/10.0-L

### Description

High-performance CP-C.1 power supplies are ABB's most advanced range. With excellent efficiency, high reliability, and innovative functionality, it is ready to take on the most demanding industrial applications. These power supplies have up to 50 % integrated power reserve and operate at an efficiency of up to 94 %. They are equipped with overheat protection and active power factor correction. Combined with a broad AC and DC input range and extensive worldwide approvals, the CP-C.1 power supplies are the preferred choice for professional DC applications.

### Ordering details - CP-C.1

Input voltage range	Rated output voltage / current	PCBA	Color	Type	Order code	Weight (1 pc.) kg (lb)
85-264 V AC, 90-300 V DC	24 V DC / 5 A	uncoated	dark grey	CP-C.1 24/5.0	1SVR360563R1001	0.87 (1.92)
	24 V DC / 10 A			CP-C.1 24/10.0	1SVR360663R1001	1.21 (2.67)
	24 V DC / 20 A			CP-C.1 24/20.0	1SVR360763R1001	1.70 (3.75)
	24 V DC / 5 A	coated		CP-C.1 24/5.0-C	1SVR360563R2001	0.87 (1.92)
	24 V DC / 10 A			CP-C.1 24/10.0-C	1SVR360663R2001	1.24 (2.73)
	24 V DC / 20 A			CP-C.1 24/20.0-C	1SVR360763R2001	1.72 (3.79)
	24 V DC / 5 A	uncoated	light grey	CP-C.1 24/5.0-L	1SVR361563R1001	0.87 (1.92)
	24 V DC / 10 A			CP-C.1 24/10.0-L	1SVR361663R1001	1.21 (2.67)
	24 V DC / 20 A			CP-C.1 24/20.0-L	1SVR361763R1001	1.70 (3.75)

## CP-C.1 range

### Technical data

Data at  $T_a = 25\text{ °C}$ ,  $U_{in} = 230\text{ V AC}$  and rated values, unless otherwise indicated

Type	CP-C.1 24/5.0, CP-C.1 24/5.0-L		CP-C.1 24/5.0-C
<b>Input circuit - Supply circuit</b>			
		<b>L (+), N (-)</b>	
Rated input voltage $U_{in}$		100-240 V AC, 100-270 V DC	
Input voltage range		85-264 V AC, 90-300 V DC	
Input current range at rated output power	100-240 V AC	0.6-1.4 A	
	100-270 V DC	0.5-1.6 A	
Typical input current	at 115 V AC	1.1 A	
	at 230 V AC	0.6 A	
Typical power consumption	at 230 V AC	132 W	
Rated frequency		DC, 50/60 Hz	
Frequency range	AC	45-65 Hz	
Inrush current, cold state		< 8 A	
Let-through energy $I^2t$ , cold state	at 230 V AC	< 1 A <sup>2</sup> s	
Discharge current towards PE		< 3.5 mA	
Hold-up time	at 115 V AC	min. 50 ms	
	at 230 V AC	min. 50 ms	
Internal input fuse		T4.0 A, not exchangeable	
Recommended backup fuse for wire protection at 1.5 mm <sup>2</sup>		1 pole miniature circuit breaker ABB type S 200 For USA/CAN: Use appropriate branch circuit 20 A fuse acc. regional and national regulations.	
	characteristic	B or C	
	max. rating	16 A	
Power factor correction (PFC)		yes, active	
Transient overvoltage protection		yes, varistor	
<b>User interface</b>			
<b>Indication of operational states</b>			
Output voltage	LED 'OUTPUT OK' (green)	ON	≥ 92 % of adjusted $U_{out}$
		flashing	< 90 % of adjusted $U_{out}$
Power reserve	LED 'I > I <sub>R</sub> ' (yellow)	OFF	$I \leq I_R$
		ON	$I > I_R$
<b>Output circuit - Power output</b>			
		<b>L+, L-</b>	
Rated output voltage		24 V DC	
Tolerance of the output voltage		± 1 %	
Adjustment range of the output voltage		22.5-28.5 V DC	
Rated output power		120 W	
Rated output current $I_R$	- 25 °C ≤ $T_a$ ≤ 60 °C	5.0 A	-
	- 40 °C ≤ $T_a$ ≤ 60 °C	-	5.0 A
Reserve output current	- 25 °C ≤ $T_a$ ≤ 40 °C	7.5 A continuously	-
	- 40 °C ≤ $T_a$ ≤ 40 °C	-	7.5 A continuously
Short-circuit current limiting		7.6 A	
Derating of the output current	60 °C < $T_a$ ≤ 70 °C	2.5 %/°C	
Deviation width of output voltage	static output voltage deviation 25-100 %	< 1 %	
	dynamical 0-100 %	< 2 %	
	change of input voltage within the rated input voltage	< 0.1 %	
Recovery time $T_A$		< 1 ms	
Starting time after applying the supply voltage		< 500 ms	
Residual ripple and switching peaks	BW = 20 MHz	< 120 mV <sub>pp</sub> , class A	
Parallel connection		yes, up to 5 devices, to enable redundancy and to increase power, current not symmetrical	
Series connection		yes, max. 2 devices to increase voltage	

## CP-C.1 range

### Technical data

Type	CP-C.1 24/5.0, CP-C.1 24/5.0-L	CP-C.1 24/5.0-C
<b>No-load, overload and short-circuit behavior</b>		
Characteristic curve of output	U/I characteristic curve with power reserve	
Short-circuit protection	continuous short-circuit stability	
Short-circuit behavior	current limiting	
Resistance to reverse feed	≤ 35 V DC	
Overload protection	constant current limitation	
Overtemperature protection	protection by switch off in case of overtemperature (thermal protection), automatic restart	
No-load protection	continuous no-load stability	
Starting of capacitive loads	yes	
<b>Signaling outputs</b>		
<b>OUTPUT OK signaling output</b>		
Type of output	13-14	relay, n/o contact
ON (contact closed)		≥ 92 % of adjusted $U_{out}$
OFF (contact open)		< 90 % of adjusted $U_{out}$
Contact ratings	max. switching voltage / current	30 V AC - 0.5 A / 24 V DC - 1 A (resistive load)
	min. switching voltage / current	5 V DC / 1 mA
<b>POWER RESERVE signaling output</b>		
Type of output	$I > I_R$	transistor, short-circuit proof
Active / ON (closed)		$I > I_R$
Inactive / OFF (open)		$I \leq I_R$
Ratings	voltage/current	24 V DC / ≤ 20 mA
<b>General data</b>		
Efficiency	at rated output power	up to 93 %
Power loss	at rated output power	12 W
	at 50% of rated output power	8 W
	at no load	< 3.6 W
Duty cycle		100 %
MTBF	acc. to MIL 217 HDBK	on request
Dimensions		see "Dimensional drawings"
Material of housing	cover	zinc-coated sheet-steel
	housing shell	aluminium
	front	plastic, PA6, V-2
Mounting		DIN rail (IEC/EN 60715), snap-on mounting
Mounting position		see "Mounting positions" in the data sheet
Minimum distance to other units	horizontal	25 mm (0.98 in)
	vertical	25 mm (0.98 in)
Degree of protection (IEC/EN 60529)	housing / terminals	IP20 / IP20
Protection class (IEC/EN 61140)		I
<b>Electrical connection</b>		
<b>Input circuits (L(+), N(-), PE)</b>		
Connecting capacity	rigid	0.5-4.0 mm <sup>2</sup> (20-10 AWG)
	fine-strand with(out) wire end ferrule	0.5-2.5 mm <sup>2</sup> (20-12 AWG)
Stripping length		8 mm (0.315 in)
Tightening torque		0.5 Nm (4.4 lb.in)
Recommended screw driver		PH1 / Ø 4.0 x 0.8 mm
<b>Output circuits (L+, L+, L-, L-)</b>		
Connecting capacity	rigid	0.5-4.0 mm <sup>2</sup> (20-10 AWG)
	fine-strand with(out) wire end ferrule	0.5-2.5 mm <sup>2</sup> (20-12 AWG)
Stripping length		8 mm (0.315 in)
Tightening torque		0.5 Nm (4.4 lb.in)
Recommended screw driver		PH1 / Ø 4.0 x 0.8 mm



## CP-C.1 range

### Technical data

Type		CP-C.1 24/5.0, CP-C.1 24/5.0-L	CP-C.1 24/5.0-C
<b>Signaling output (13-14, I &gt; IR)</b>			
Connecting capacity	rigid	0.5-4.0 mm <sup>2</sup> (20-10 AWG)	
	fine-strand with(out) wire end ferrule	0.5-2.5 mm <sup>2</sup> (20-12 AWG)	
Stripping length		8 mm (0.315 in)	
Tightening torque		0.5 Nm (4.4 lb.in)	
Recommended screw driver		PH1 / Ø 4.0 x 0.8 mm	
Maximum cable length (applicable for I>IR)		30 m	
<b>Environmental data</b>			
Ambient temperature range	operation	-25...+70 °C (-13... +158 °F)	-40...+70 °C (-40...+158 °F)
	rated output power	-25...+60 °C (-13... +140 °F)	-40...+60 °C (-40...+140 °F)
	storage	-40...+85 °C (-40...+185 °F)	
	transportation	-40...+85 °C (-40...+185 °F)	
Climatic class (IEC/EN 60721-3-1)	storage	1K2	
Climatic class (IEC/EN 60721-3-2)	transportation	2K2	
Climatic class (IEC/EN 60721-3-3)	operation	3K3	
Damp heat, cyclic (IEC/EN 60068-2-30)		test Db: 55 °C, 2 cycles	
Vibration (IEC/EN 60068-2-6)		test Fc: 10-58 Hz, amplitude ±0.15 mm, 58-150 Hz, 2 g, 10 sweep cycles each axis	
Shock, half-sine (IEC/EN 60068-2-27)		test Ea: 30 g, 6 ms, 3 pulses each axis; bump 20 g, 11 ms, 100 pulses each axis	
Coated PCBA		no	yes
Gaseous corrosive environment withstand test (IEC/EN 60068-2-60)		-	testing method: 4 testing period: 21 days ambient conditions: 25 °C, 75 % r.h. air/volume change rate per hour: 3-6 sample not energized during exposure gas concentrations acc. ISA-S71.04.2013 Harsh Group A, G3 IEC 60721-3.3 acc. 3C2/3C3 - H <sub>2</sub> S ≥ 100 ± 10 ppb - SO <sub>2</sub> /SO <sub>3</sub> ≥ 300 ± 20 ppb - Cl <sub>2</sub> ≥ 100 ± 10 ppb - NO <sub>x</sub> ≥ 1250 ± 20 ppb
<b>Isolation data</b>			
Rated impulse withstand voltage U <sub>imp</sub> (EN62477-1)	input circuit / output circuit	4 kV (1.2/50 μs)	
	input circuit / PE	4 kV (1.2/50 μs)	
	input circuit / relay contact	4 kV (1.2/50 μs)	
	output circuit / relay contact	0.5 kV (1.2/50 μs)	
	relay contact / PE	0.5 kV (1.2/50 μs)	
	output circuit / PE	0.5 kV (1.2/50 μs)	
	System voltage (EN 62477-1)	input circuit / output circuit	300 V
input circuit / PE		300 V	
input circuit / relay contact		300 V	
output circuit / relay contact		50 V	
relay contact / PE		50 V	
output circuit / PE		50 V	
Overvoltage category (IEC/EN 62477-1)	< 2000 m	III	
	2000...5000 m	II	
Overvoltage category (IEC/EN 61010-1)	< 2000 m	II	
Pollution degree		2	
Protective separation (IEC/EN 61010-1, 61010-2-201 and IEC60950-1)	input circuit / output circuit	yes	
	input circuit / relay contact	yes	

## CP-C.1 range

### Technical data

Type	CP-C.1 24/5.0, CP-C.1 24/5.0-L   CP-C.1 24/5.0-C	
<b>Standards / Directives</b>		
Standards	IEC/EN 61204	
Low Voltage Directive	2014/35/EU	
EMC Directive	2014/30/EU	
ATEX Directive	-	2014/34/EU
RoHS Directive	2011/65/EU	
Electrical safety	IEC/EN 61010-1, IEC/EN 61010-2-201 and IEC/EN 60950-1	
Process control equipment	UL 61010-1, UL 61010-2-201 / CAN/CSA C22.2 No. 61010-1-12, CAN/CSA-IEC 61010-2-201:18	
Protective extra low voltage	PELV (IEC/EN 61010-2-201)	
Safety extra low voltage	SELV (IEC/EN 61010-2-201, IEC60950-1)	
Limitation of harmonic line currents	IEC/EN 61000-3-2	
<b>Electromagnetic compatibility</b>		
Low-voltage power supplies, d.c. output – Part 3: Electromagnetic compatibility (EMC)	IEC/EN 61204-3	
Interference immunity to	IEC/EN 61000-6-2	
electrostatic discharge (ESD)	IEC/EN 61000-4-2	level 4, 8 kV / 15 kV (criterion A)
radiated, radio-frequency, electromagnetic field	IEC/EN 61000-4-3	level 3, 10 V/m (criterion A)
electrical fast transient / burst	IEC/EN 61000-4-4	level 4, 4 kV / 2 kV (criterion A)
surge	IEC/EN 61000-4-5	level 4, L/N 2 kV (criterion A) level 4, L,N/PE 4 kV (criterion A)
conducted disturbances, induced by radio-frequency fields	IEC/EN 61000-4-6	level 3, 10 V (criterion A)
voltage dips, short interruptions and voltage variations	IEC/EN 61000-4-11	class 3
harmonics and interharmonics	IEC/EN 61000-4-13	class 3 (criterion A)
conducted, common mode disturbances in the frequency range 0 Hz to 150 kHz	IEC/EN 61000-4-16	level 3, 10 V
Interference emission	IEC/EN 61000-6-3	
limits for harmonic current emissions	IEC/EN 61000-3-2	class A
limitation of voltage changes etc.	IEC/EN 61000-3-3	compliant
Electromagnetic compatibility of multimedia equipment - Emission requirements	IEC/CISPR 32, EN 55032	class B
Industrial scientific and medical (ISM) radio-frequency equipment electromagnetic disturbance characteristics limits and methods of measurement	IEC/CISPR 11, EN 55011	class B
Voltage sags	SEMI F47	passed
Federal Communications Commission	FCC15	compliant

## CP-C.1 range

### Technical data

Data at  $T_a = 25\text{ °C}$ ,  $U_{in} = 230\text{ V AC}$  and rated values, unless otherwise indicated

Type	CP-C.1 24/10.0, CP-C.1 24/10.0-L	CP-C.1 24/10.0-C	
<b>Input circuit - Supply circuit</b>			
	<b>L (+), N (-)</b>		
Rated input voltage $U_{in}$	100-240 V AC, 100 - 270 V DC		
Input voltage range	85-264 V AC, 90-300 V DC		
Input current range and output power	100-240 V AC	1.2-2.7 A	
	100-270 V DC	0.9-3.1 A	
Typical input current	at 115 V AC	2.3 A	
	at 230 V AC	1.2 A	
Typical power consumption	at 230 V AC	256 W	
Rated frequency	DC, 50/60 Hz		
Frequency range	AC	45-65 Hz	
Inrush current, cold state	< 11 A		
Let-through energy $I^2t$ , cold state	at 230 V AC	< 1,5 A <sup>2</sup> s	
Discharge current towards PE	< 3.5 mA		
Hold-up time	at 115 V AC	min. 40 ms	
	at 230 V AC	min. 40 ms	
Internal input fuse	T6.3 A, not exchangeable		
Recommended backup fuse for wire protection at 1.5 mm <sup>2</sup>	1 pole miniature circuit breaker ABB type S 200 For USA/CAN: Use appropriate branch circuit 20 A fuse acc. regional and national regulations.		
	characteristic	B or C	
	max. rating	16 A	
Power factor correction (PFC)	yes, active		
Transient overvoltage protection	yes, varistor		
<b>User interface</b>			
<b>Indication of operational states</b>			
Output voltage	LED 'OUTPUT OK' (green)	ON	$\geq 92\%$ of adjusted $U_{out}$
		flashing	< 90 % of adjusted $U_{out}$
Power reserve	LED 'I > I <sub>R</sub> ' (yellow)	OFF	$I \leq I_R$
		ON	$I > I_R$
<b>Output circuit - Power output</b>			
	<b>L+, L-</b>		
Rated output voltage	24 V DC		
Tolerance of the output voltage	$\pm 1\%$		
Adjustment range of the output voltage	22.5-28.5 V DC		
Rated output power	240 W		
Rated output current $I_R$	$-25\text{ °C} \leq T_a \leq 60\text{ °C}$	10.0 A	-
	$-40\text{ °C} \leq T_a \leq 60\text{ °C}$	-	10.0 A
Reserve output current	$-25\text{ °C} \leq T_a \leq 40\text{ °C}$	15.0 A continuously	-
	$-40\text{ °C} \leq T_a \leq 60\text{ °C}$	-	15.0 A continuously
Short-circuit current limiting	15.5 A		
Derating of the output current	$60\text{ °C} < T_a \leq 70\text{ °C}$	2.5 %/°C	2.5 %/°C
Deviation width of output voltage	static output voltage deviation 25-100 %	< 1%	
		dynamic 0-100 % < 5 %	
	change of input voltage within the rated input voltage	< 0.1 %	
Recovery time $T_A$	< 1 ms		
Starting time after applying the supply voltage	< 500 ms		
Residual ripple and switching peaks	BW = 20 MHz	< 120 mV <sub>pp</sub> , class A	
Parallel connection	yes, up to 5 devices, to enable redundancy and to increase power, current not symmetrical		
Series connection	yes, max. 2 devices to increase voltage		

## CP-C.1 range

### Technical data

Type	CP-C.1 24/10.0, CP-C.1 24/10.0-L	CP-C.1 24/10.0-C
<b>No-load, overload and short-circuit behavior</b>		
Characteristic curve of output	U/I characteristic curve with power reserve	
Short-circuit protection	continuous short-circuit stability	
Short-circuit behavior	current limiting	
Resistance to reverse feed	≤ 35 V DC	
Overload protection	constant current limitation	
Overtemperature protection	protection by switch off in case of overtemperature (thermal protection), automatic restart	
No-load protection	continuous no-load stability	
Starting of capacitive loads	yes	
<b>Signaling outputs</b>		
<b>OUTPUT OK signaling output</b>		
Type of output	13-14	relay, n/o contact
ON (contact closed)	≥ 92 % of adjusted $U_{out}$	
OFF (contact open)	< 90 % of adjusted $U_{out}$	
Contact ratings	max. switching voltage / current	30 V AC - 0.5 A / 24 V DC - 1 A (resistive load)
	min. switching voltage / current	5 V DC / 1 mA
<b>POWER RESERVE signaling output</b>		
Type of output	$I > I_R$	transistor, short-circuit proof
Active / ON (closed)	$I > I_R$	
Inactive / OFF (open)	$I \leq I_R$	
Ratings	voltage/current	24 V DC / ≤ 20 mA
<b>General data</b>		
Efficiency	at rated output power	up to 94 %
Power loss	at rated output power	16 W
	at 50% of rated output power	12 W
	at no load	< 3.6 W
Duty cycle	100 %	
MTBF	acc. to MIL 217 HDBK	on request
Dimensions	see "Dimensional drawings"	
Material of housing	cover	zinc-coated sheet-steel
	housing shell	aluminium
	front	plastic, PA6, V-2
Mounting	DIN rail (IEC/EN 60715), snap-on mounting	
Mounting position	see "Mounting positions" in the data sheet	
Minimum distance to other units	horizontal	25 mm (0.98 in)
	vertical	25 mm (0.98 in)
Degree of protection (IEC/EN 60529)	housing / terminals	IP20 / IP20
Protection class (IEC/EN 61140)	I	
<b>Electrical connection</b>		
<b>Input circuits (L(+), N(-), PE)</b>		
Connecting capacity	rigid	0.5-4.0 mm <sup>2</sup> (20-10 AWG)
	fine-strand with(out) wire end ferrule	0.5-2.5 mm <sup>2</sup> (20-12 AWG)
Stripping length	8 mm (0.315 in)	
Tightening torque	0.5 Nm (4.4 lb.in)	
Recommended screw driver	PH1 / Ø 4.0 x 0.8 mm	
<b>Output circuits (L+, L+, L-, L-)</b>		
Connecting capacity	rigid	0.5-4.0 mm <sup>2</sup> (20-10 AWG)
	fine-strand with(out) wire end ferrule	0.5-2.5 mm <sup>2</sup> (20-12 AWG)
Stripping length	8 mm (0.315 in)	
Tightening torque	0.5 Nm (4.4 lb.in)	
Recommended screw driver	PH1 / Ø 4.0 x 0.8 mm	

## CP-C.1 range

### Technical data

Type		CP-C.1 24/10.0, CP-C.1 24/10.0-L	CP-C.1 24/10.0-C
<b>Signaling output (13-14, I &gt; IR)</b>			
Connecting capacity	rigid	0.5-4.0 mm <sup>2</sup> (20-10 AWG)	
	fine-strand with(out) wire end ferrule	0.5-2.5 mm <sup>2</sup> (20-12 AWG)	
Stripping length		8 mm (0.315 in)	
Tightening torque		0.5 Nm (4.4 lb.in)	
Recommended screw driver		PH1 / Ø 4.0 x 0.8 mm	
Maximum cable length (applicable for I>I <sub>R</sub> )		30 m	
<b>Environmental data</b>			
Ambient temperature range	operation	-25...+70 °C (-13...+158 °F)	-40...+70 °C (-40...+158 °F)
	rated output power	-25...+60 °C (-13...+140 °F)	-40...+60 °C (-40...+140 °F)
	storage	-40...+85 °C (-40...+185 °F)	
	transportation	-40...+85 °C (-40...+185 °F)	
Climatic class (IEC/EN 60721-3-1)	storage	1K2	
Climatic class (IEC/EN 60721-3-2)	transportation	2K2	
Climatic class (IEC/EN 60721-3-3)	operation	3K3	
Damp heat, cyclic (IEC/EN 60068-2-30)		test Db: 55 °C, 2 cycles	
Vibration (IEC/EN 60068-2-6)		test Fc: 10-58 Hz, amplitude ±0.15 mm, 58-150 Hz, 2 g, 10 sweep cycles each axis	
Shock, half-sine (IEC/EN 60068-2-27)		test Ea: 30 g, 6 ms, 3 pulses each axis; bump 20 g, 11 ms, 100 pulses each axis	
Coated PCBA		no	yes
Gaseous corrosive environment withstand test (IEC/EN 60068-2-60)		-	testing method: 4 testing period: 21 days ambient conditions: 25 °C, 75 % r.h. air/volume change rate per hour: 3-6 sample not energized during exposure gas concentrations acc. ISA-S71.04.2013 Harsh Group A, G3 IEC 60721-3.3 acc. 3C2/3C3 - H <sub>2</sub> S ≥ 100 ± 10 ppb - SO <sub>2</sub> /SO <sub>3</sub> ≥ 300 ± 20 ppb - Cl <sub>2</sub> ≥ 100 ± 10 ppb - NO <sub>x</sub> ≥ 1250 ± 20 ppb
<b>Isolation data</b>			
Rated impulse withstand voltage U <sub>imp</sub> (EN62477-1)	input circuit / output circuit	4 kV (1.2/50 μs)	
	input circuit / PE	4 kV (1.2/50 μs)	
	input circuit / relay contact	4 kV (1.2/50 μs)	
	output circuit / relay contact	0.5 kV (1.2/50 μs)	
	relay contact / PE	0.5 kV (1.2/50 μs)	
	output circuit / PE	0.5 kV (1.2/50 μs)	
System voltage (EN62477-1)	input circuit / output circuit	300 V	
	input circuit / PE	300 V	
	input circuit / relay contact	300 V	
	output circuit / relay contact	50 V	
	relay contact / PE	50 V	
	output circuit / PE	50 V	
Overvoltage category (IEC/EN62477-1)	< 2000 m	III	
	2000...5000 m	II	
Overvoltage category (IEC/EN61010-1)	< 2000 m	II	
Pollution degree		2	
Protective separation (IEC/EN 61010-1, IEC/EN 61010-2-201 and IEC60950-1)	input circuit / output circuit	yes	
	input circuit / relay contact	yes	



## CP-C.1 range

### Technical data

Type	CP-C.1 24/10.0, CP-C.1 24/10.0-L	CP-C.1 24/10.0-C
<b>Standards / Directives</b>		
Standards	IEC/EN 61204	
Low Voltage Directive	2014/35/EU	
EMC Directive	2014/30/EU	
ATEX Directive	-	2014/34/EU
RoHS Directive	2011/65/EU	
Electrical safety	IEC/EN 61010-1, IEC/EN 61010-2-201 and IEC60950-1	
Process control equipment	UL 61010-1, UL 61010-2-201 / CAN/CSA C22.2 No. 61010-1-12, CAN/CSA-IEC 61010-2-201:18	
Protective extra low voltage	PELV (IEC/EN61010-2-201)	
Safety extra low voltage	SELV (IEC/EN 61010-2-201, IEC60950-1)	
Limitation of harmonic line currents	IEC/EN 61000-3-2	
<b>Electromagnetic compatibility</b>		
Low-voltage power supplies, d.c. output – Part 3: Electromagnetic compatibility (EMC)	IEC/EN 61204-3	
Interference immunity to	IEC/EN 61000-6-2	
electrostatic discharge (ESD)	IEC/EN 61000-4-2	level 4, 8 kV / 15 kV (criterion A)
radiated, radio-frequency, electromagnetic field	IEC/EN 61000-4-3	level 3, 10 V/m (criterion A)
electrical fast transient / burst	IEC/EN 61000-4-4	level 4, 4 kV / 2 kV (criterion A)
surge	IEC/EN 61000-4-5	level 4, L/N 2 kV (criterion A) level 4, L,N/PE 4 kV (criterion A)
conducted disturbances, induced by radio-frequency fields	IEC/EN 61000-4-6	level 3, 10 V (criterion A)
voltage dips, short interruptions and voltage variations	IEC/EN 61000-4-11	class 3
harmonics and interharmonics	IEC/EN 61000-4-13	class 3 (Criterion A)
conducted, common mode disturbances in the frequency range 0 Hz to 150 kHz	IEC/EN 61000-4-16	level 3, 10 V
Interference emission	IEC/EN 61000-6-3	
limits for harmonic current emissions	IEC/EN 61000-3-2	class A
limitation of voltage changes etc.	IEC/EN 61000-3-3	compliant
Electromagnetic compatibility of multimedia equipment - Emission requirements	IEC/CISPR 32, EN 55032	class B
Industrial scientific and medical (ISM) radio-frequency equipment electromagnetic disturbance characteristics limits and methods of measurement	IEC/CISPR 11, EN 55011	class B
Voltage sags	SEMI F47	passed
Federal Communications Commission	FCC15	compliant

## CP-C.1 range

### Technical data

Data at  $T_a = 25\text{ °C}$ ,  $U_{in} = 230\text{ V AC}$  and rated values, unless otherwise indicated

Type	CP-C.1 24/20.0, CP-C.1 24/20.0-L		CP-C.1 24/20.0-C
<b>Input circuit - Supply circuit</b>			
		<b>L (+), N (-)</b>	
Rated input voltage $U_{in}$		100-240 V AC, 100-270 V DC	
Input voltage range		85-264 V AC, 90-300 V DC	
Input current voltage and rated output power	100-240 V AC	2.3-5.3 A	
	100-270 V DC	1.5-5.9 A	
Typical input current	at 115 V AC	4.6 A	
	at 230 V AC	2.3 A	
Typical power consumption	at 230 V AC	508 W	
Rated frequency		DC, 50/60 Hz	
Frequency range	AC	45-65 Hz	
Inrush current, cold state		< 11 A	
Let-through energy $I^2t$ , cold state	at 230 V AC	< 3 A <sup>2</sup> s	
Discharge current towards PE		< 3.5 mA	
Hold-up time	at 115 V AC	min. 40 ms	
	at 230 V AC	min. 40 ms	
Internal input fuse		T12 A, not exchangeable	
Recommended backup fuse for wire protection at 1.5 mm <sup>2</sup>		1 pole miniature circuit breaker ABB type S 200 For USA/CAN: Use appropriate branch circuit 20 A fuse acc. regional and national regulations.	
	characteristic	B or C	
	max. rating	16 A	
Power factor correction (PFC)		yes, active	
Transient overvoltage protection		yes, varistor	
<b>User interface</b>			
<b>Indication of operational states</b>			
Output voltage	LED 'OUTPUT OK' (green)	ON	≥ 92 % of adjusted $U_{out}$
		flashing	< 90 % of adjusted $U_{out}$
Power reserve	LED 'I > I <sub>R</sub> ' (yellow)	OFF	$I \leq I_R$
		ON	$I > I_R$
<b>Output circuit - Power output</b>			
		<b>L+, L-</b>	
Rated output voltage		24 V DC	
Tolerance of the output voltage		± 1 %	
Adjustment range of the output voltage		22.5-28.5 V DC	
Rated output power		480 W	
Rated output current $I_R$	- 25 °C ≤ $T_a$ ≤ 60 °C	20 A	-
	- 40 °C ≤ $T_a$ ≤ 60 °C	-	20 A
Reserve output current	- 25 °C ≤ $T_a$ ≤ 40 °C	26.0 A continuously	-
	- 40 °C ≤ $T_a$ ≤ 60 °C	-	26.0 A continuously
Short-circuit current limiting		27.7 A	
Derating of the output current	60 °C < $T_a$ ≤ 70 °C	2.5 %/°C	
Deviation width of output voltage	static output voltage deviation 25-100 %	< 1 %	
	dynamical 0-100 %	< 5 %	
	change of input voltage within the rated input voltage	< 0.1 %	
Recovery time $T_A$		< 1 ms	
Starting time after applying the supply voltage		< 500 ms	
Residual ripple and switching peaks	BW = 20 MHz	< 120 mV <sub>pp</sub> , class A	
Parallel connection		yes, up to 5 devices, to enable redundancy and to increase power, current not symmetrical	
Series connection		yes, max. 2 devices to increase voltage	

## CP-C.1 range

### Technical data

Type		CP-C.1 24/20.0, CP-C.1 24/20.0-L	CP-C.1 24/20.0-C
<b>No-load, overload and short-circuit behavior</b>			
Characteristic curve of output		U/I characteristic curve with power reserve	
Short-circuit protection		continuous short-circuit stability	
Short-circuit behavior		current limiting	
Resistance to reverse feed		≤ 35 V DC	
Overload protection		constant current limitation	
Overtemperature protection		protection by switch off in case of overtemperature (thermal protection), automatic restart	
No-load protection		continuous no-load stability	
Starting of capacitive loads		yes	
<b>Signaling outputs</b>			
<b>OUTPUT OK signaling output</b>			
Type of output	13-14	relay, n/o contact	
ON (contact closed)		≥ 92 % of adjusted $U_{out}$	
OFF (contact open)		< 90 % of adjusted $U_{out}$	
Contact ratings	max. switching voltage / current	30 V AC - 0.5 A / 24 V DC - 1 A (resistive load)	
	min. switching voltage / current	5 V DC / 1 mA	
<b>POWER RESERVE signaling output</b>			
Type of output	$I > I_R$	transistor, short-circuit proof	
Active / ON (closed)		$I > I_R$	
Inactive / OFF (open)		$I \leq I_R$	
Ratings	voltage/current	24 V DC / ≤ 20 mA	
<b>General data</b>			
Efficiency	at rated output power	up to 94 %	
Power loss	at rated output power	28 W	
	at 50 % of rated output power	17 W	
	at no load	< 3.6 W	
Duty cycle		100 %	
MTBF	acc. to MIL 217 HDBK	on request	
Dimensions		see "Dimensional drawings"	
Material of housing	cover	zinc-coated sheet-steel	
	housing shell	aluminium	
	front	plastic, PA6, V-2	
Mounting		DIN rail (IEC/EN 60715), snap-on mounting	
Mounting position		see "Mounting positions" in the data sheet	
Minimum distance to other units	horizontal	25 mm (0.98 in)	
	vertical	25 mm (0.98 in)	
Degree of protection (IEC/EN 60529)	housing / terminals	IP20 / IP20	
Protection class (IEC/EN 61140)		I	
<b>Electrical connection</b>			
<b>Input circuits (L(+), N(-), PE)</b>			
Connecting capacity	rigid	0.5-4.0 mm <sup>2</sup> (20-10 AWG)	
	fine-strand with(out) wire end ferrule	0.5-2.5 mm <sup>2</sup> (20-12 AWG)	
Stripping length		8 mm (0.315 in)	
Tightening torque		0.5 Nm (4.4 lb.in)	
Recommended screw driver		PH1 / Ø 4.0 x 0.8 mm	

## CP-C.1 range

### Technical data

Type	CP-C.1 24/20.0, CP-C.1 24/20.0-L		CP-C.1 24/20.0-C
<b>Output circuits (L+, L+, L-, L-)</b>			
Connecting capacity	rigid	2.5-16.0 mm <sup>2</sup> (12-6 AWG)	
	fine-strand with(out) wire end ferrule	2.5-10 mm <sup>2</sup> (12-8 AWG)	
Stripping length	10 mm (0.394 in)		
Tightening torque	1.2 Nm (10.5 lb-in)		
Recommended screw driver	PH1 / Ø 4.0 x 0.8 mm		
<b>Signaling output (13-14, I &gt; IR)</b>			
Connecting capacity	rigid	0.5-4.0 mm <sup>2</sup> (20-10 AWG)	
	fine-strand with(out) wire end ferrule	0.5-2.5 mm <sup>2</sup> (20-12 AWG)	
Stripping length	8 mm (0.315 in)		
Tightening torque	0.5 Nm (4.4 lb.in)		
Recommended screw driver	PH1 / Ø 4.0 x 0.8 mm		
Maximum cable length (applicable for I>I <sub>R</sub> )	30 m		
<b>Environmental data</b>			
Ambient temperature range	operation	-25...+70 °C (-13...+158 °F)	-40...+70 °C (-40...+158 °F)
	rated output power	-25...+60 °C (-13...+140 °F)	-40...+60 °C (-40...+140 °F)
	storage	-40...+85 °C (-40...+185 °F)	
	transportation	-40...+85 °C (-40...+185 °F)	
Climatic class (IEC/EN 60721-3-1)	storage	1K2	
Climatic class (IEC/EN 60721-3-2)	transportation	2K2	
Climatic class (IEC/EN 60721-3-3)	operation	3K3	
Damp heat, cyclic (IEC/EN 60068-2-30)	test Db: 55 °C, 2 cycles		
Vibration (IEC/EN 60068-2-6)	test Fc: 10-58 Hz, amplitude ±0.15 mm, 58-150 Hz, 2 g, 10 sweep cycles each axis		
Shock, half-sine (IEC/EN 60068-2-27)	test Ea: 30 g, 6 ms, 3 pulses each axis; bump 20 g, 11 ms, 100 pulses each axis		
Coated PCBA	no	yes	
Gaseous corrosive environment withstand test (IEC/EN 60068-2-60)	-	testing method: 4 testing period: 21 days ambient conditions: 25 °C, 75 % r.h. air/volume change rate per hour: 3-6 sample not energized during exposure gas concentrations acc. ISA-S71.04.2013 Harsh Group A, G3 IEC 60721-3.3 acc. 3C2/3C3 - H <sub>2</sub> S ≥ 100 ± 10 ppb - SO <sub>2</sub> /SO <sub>3</sub> ≥ 300 ± 20 ppb - Cl <sub>2</sub> ≥ 100 ± 10 ppb - NO <sub>x</sub> ≥ 1250 ± 20 ppb	

## CP-C.1 range

### Technical data

Type		CP-C.1 24/20.0, CP-C.1 24/20.0-L	CP-C.1 24/20.0-C
<b>Isolation data</b>			
Rated impulse withstand voltage $U_{imp}$ (EN62477-1)	input circuit / output circuit	4 kV (1.2/50 $\mu$ s)	
	input circuit / PE	4 kV (1.2/50 $\mu$ s)	
	input circuit / relay contact	4 kV (1.2/50 $\mu$ s)	
	output circuit / relay contact	0.5 kV (1.2/50 $\mu$ s)	
	relay contact / PE	0.5 kV (1.2/50 $\mu$ s)	
	output circuit / PE	0.5 kV (1.2/50 $\mu$ s)	
System voltage (EN62477-1)	input circuit / output circuit	300 V	
	input circuit / PE	300 V	
	input circuit / relay contact	300 V	
	output circuit / relay contact	50 V	
	relay contact / PE	50 V	
	output circuit / PE	50 V	
Overvoltage category (EN62477-1)	< 2000 m	III	
	2000...5000 m	II	
Overvoltage category (IEC/EN61010-1)	< 2000 m	II	
Pollution degree		2	
Protective separation IEC/EN61010-1, IEC/EN61010-2-201 and IEC60950-1)	input circuit / output circuit	yes	
	input circuit / relay contact	yes	
<b>Standards / Directives</b>			
Standards		IEC/EN 61204	
Low Voltage Directive		2014/35/EU	
EMC Directive		2014/30/EU	
ATEX Directive		-	2014/34/EU
RoHS Directive		2011/65/EU	
Electrical safety		IEC / EN 61010-1, IEC / EN 61010-2-201 and IEC60950-1	
Process control equipment		UL 61010-1, UL 61010-2-201 / CAN/CSA C22.2 No. 61010-1-12, CAN/CSA-IEC 61010-2-201:18	
Protective extra low voltage		PELV (IEC/EN 61010-2-201)	
Safety extra low voltage		SELV (IEC/EN 61010-2-201 and IEC60950-1)	
Limitation of harmonic line currents		IEC/EN 61000-3-2	
<b>Electromagnetic compatibility</b>			
Low-voltage power supplies, d.c. output – Part 3: Electromagnetic compatibility (EMC)		IEC/EN 61204-3	
Interference immunity to		IEC/EN 61000-6-2	
electrostatic discharge (ESD)	IEC/EN 61000-4-2	level 4, 8 kV / 15 kV (criterion A)	
radiated, radio-frequency, electromagnetic field	IEC/EN 61000-4-3	level 3, 10 V/m (criterion A)	
electrical fast transient / burst	IEC/EN 61000-4-4	level 4, 4 kV / 2 kV (criterion A)	
surge	IEC/EN 61000-4-5	level 4, L/N 2 kV (criterion A) level 4, L,N/PE 4 kV (criterion A)	
conducted disturbances, induced by radio-frequency fields	IEC/EN 61000-4-6	level 3, 10 V (criterion A)	
voltage dips, short interruptions and voltage variations	IEC/EN 61000-4-11	class 3	
harmonics and interharmonics	IEC/EN 61000-4-13	class 3 (Criterion A)	
conducted, common mode disturbances in the frequency range 0 Hz to 150 kHz	IEC/EN 61000-4-16	level 3, 10 V	
Interference emission		IEC/EN 61000-6-3	
limits for harmonic current emissions	IEC/EN 61000-3-2	class A	
limitation of voltage changes etc.	IEC/EN 61000-3-3	compliant	
Electromagnetic compatibility of multimedia equipment - Emission requirements	IEC/CISPR 32, EN 55032	class B	
Industrial scientific and medical (ISM) radio-frequency equipment electromagnetic disturbance characteristics limits and methods of measurement	IEC/CISPR 11, EN 55011	class B	
Voltage sags	SEMI F47	passed	
Federal Communications Commission	FCC15	compliant	



# CP-C.1 range

## Technical diagrams

### CP-C.1 24/5.0, CP-C.1 24/5.0-L and CP-C.1 24/5.0-C

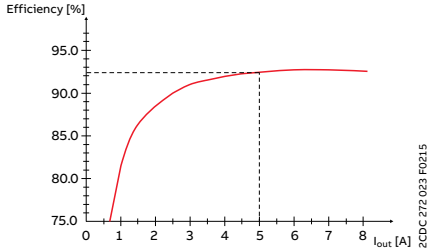

Typical efficiency over output current

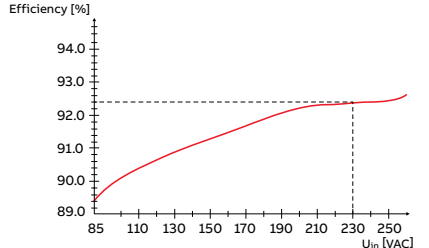

Typical efficiency over AC input voltage

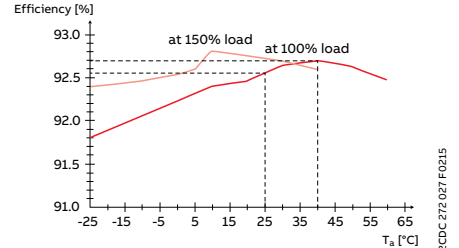

Typical efficiency over ambient temperature

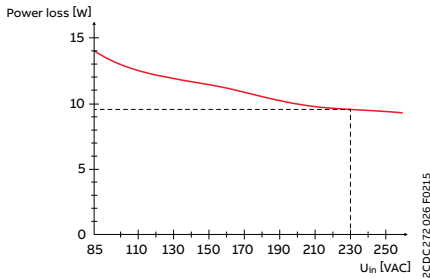

Typical power loss over AC input voltage

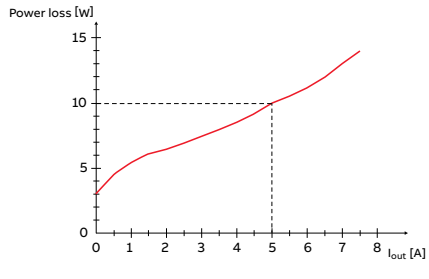

Typical power loss over output current

### CP-C.1 24/10.0, CP-C.1 24/10.0-L and CP-C.1 24/10.0-C

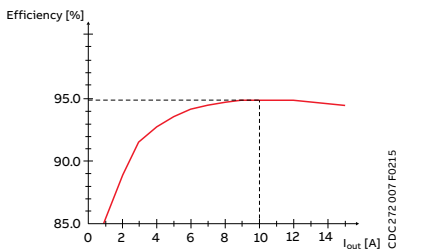

Typical efficiency over output current

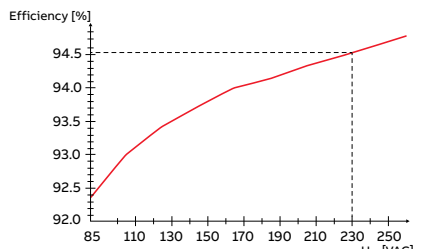

Typical efficiency over AC input voltage

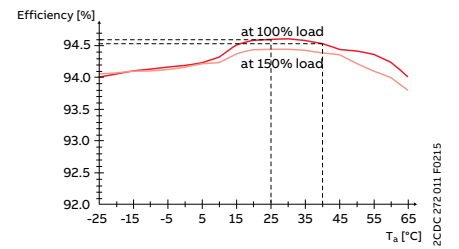

Typical efficiency over ambient temperature

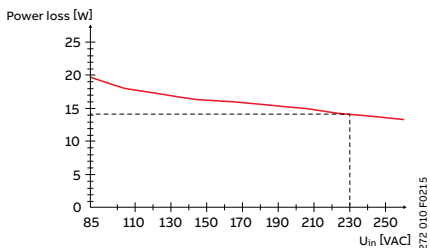

Typical power loss over AC input voltage

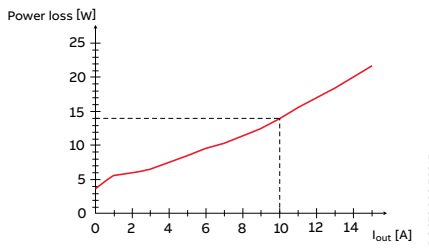

Typical power loss over output current

# CP-C.1 range

## Technical diagrams

### CP-C.1 24/20.0, CP-C.1 24/20.0-L and CP-C.1 24/20.0-C

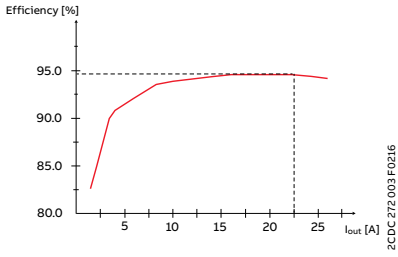

Typical efficiency over output current

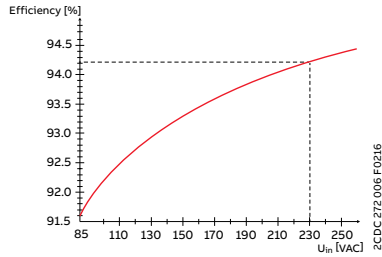

Typical efficiency over AC input voltage

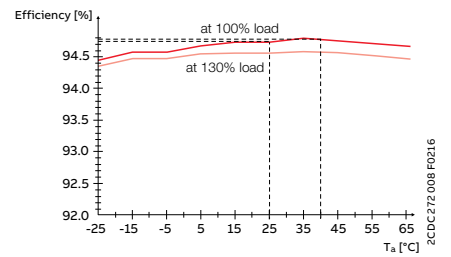

Typical efficiency over ambient temperature

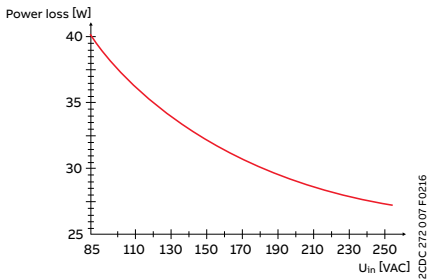

Typical power loss over AC input voltage

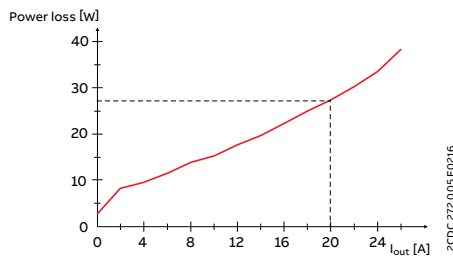

Typical power loss over output current

# CP-C.1 range

## Technical diagrams

### Characteristic curve of output at $T_a = 25^\circ\text{C}$

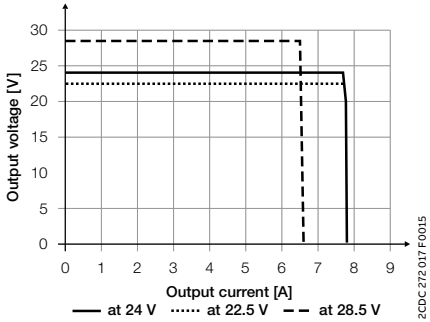

CP-C.1 24/5.0, CP-C.1 24/5.0-L  
CP-C.1 24/5.0-C

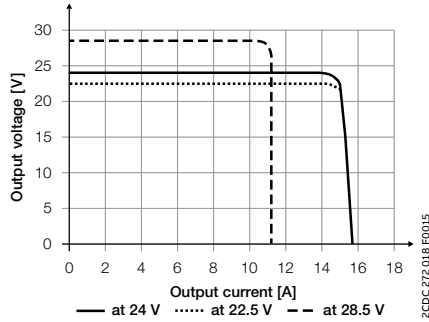

CP-C.1 24/10.0, CP-C.1 24/10.0-L  
CP-C.1 24/10.0-C

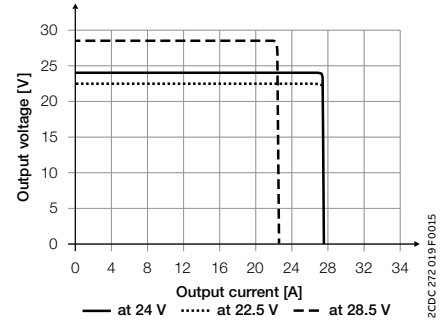

CP-C.1 24/20.0, CP-C.1 24/20.0-L  
CP-C.1 24/20.0-C

### Characteristic curve of temperature at $U_{out} = 24\text{ V}$

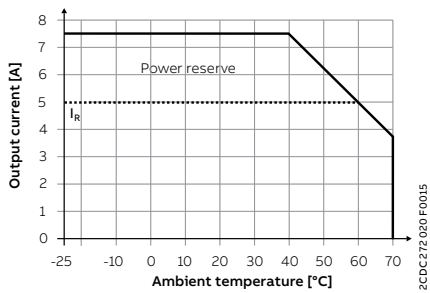

CP-C.1 24/5.0, CP-C.1 24/5.0-L

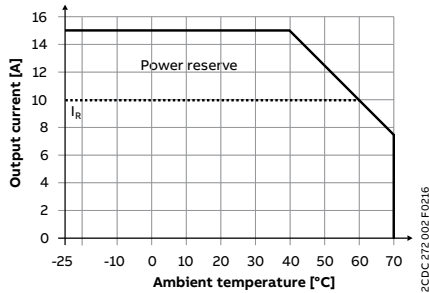

CP-C.1 24/10.0, CP-C.1 24/10.0-L

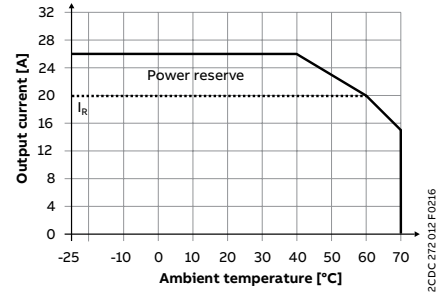

CP-C.1 24/20.0, CP-C.1 24/20.0-L

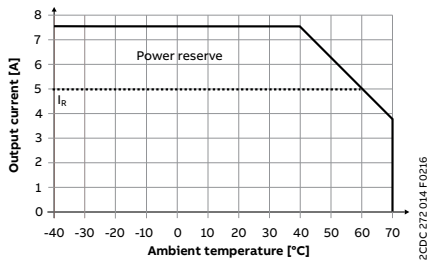

CP-C.1 24/5.0-C

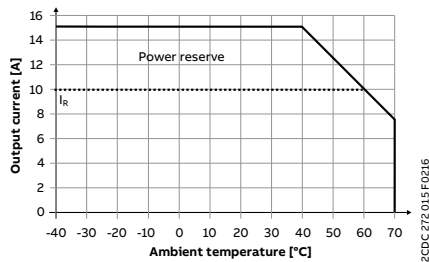

CP-C.1 24/10.0-C

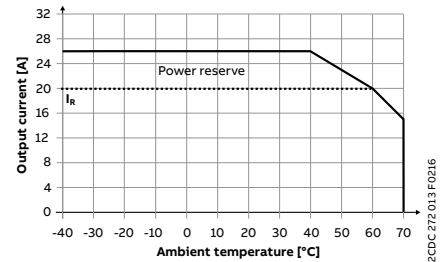

CP-C.1 24/20.0-C

# CP-C.1 range

## Technical diagrams

### Dimensional drawings

Dimensions in mm and inches

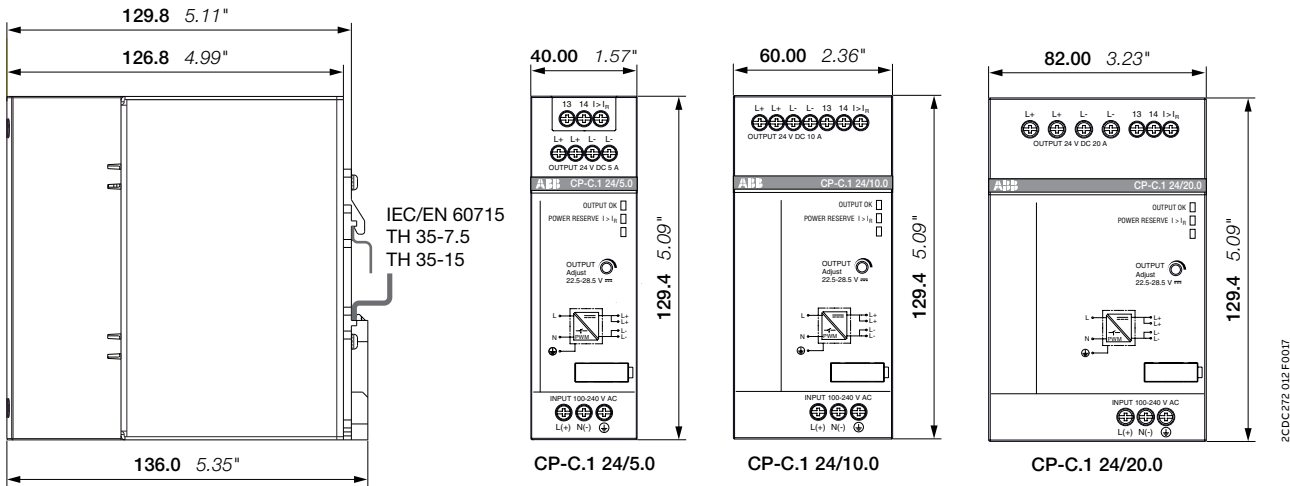

2CDC272 012-F0017







---

# Power supplies for building applications

## Table of contents

<b>90</b>	<b>CP-D range</b>
<b>90</b>	<b>Benefits and advantages</b>
<b>92</b>	<b>Operation controls</b>
<b>93</b>	<b>Applications</b>
<b>94</b>	<b>Ordering details</b>
<b>95</b>	<b>Technical data</b>
<b>99</b>	<b>Technical diagrams</b>

## CP-D range

### Benefits and advantages



Thanks to its compact modular housing, the CP-D range is ideal for building applications and installation. For maximum flexibility in operation, six different versions are available, from 10 W up to 100 W. Their wide input voltage range allows their use in global applications.



#### Easy to install

The CP-D range is easy to adjust and ideally suited for installation in distribution panels due to its width being only 18 to 90 mm.



#### Global availability

The product can be used in any installation in the world. Giving you the confidence of worldwide sourcing – no matter where you build, install or operate your equipment.



#### Speed up your projects

Data available for common planning software: Less engineering time required.

## CP-D range

### Benefits and advantages



#### Characteristics

- Output voltages 12 V, 24 V DC
- Adjustable output voltages (devices > 10 W)
- Output currents 0.42 A / 0.83 A / 1.3 A / 2.1 A / 2.5 A / 4.2 A
- Power range 10 W, 25 W, 30 W, 60 W, 100 W
- Wide range input 100-240 V AC (90-264 V AC, 120-375 V DC)
- High efficiency of up to 89 %
- Low power dissipation and low heating
- Free convection cooling (no forced cooling with ventilators)
- Ambient temperature range during operation -40...+70 °C
- Open-circuit, overload and short-circuit stable
- Integrated input fuse
- LEDs for status indication
- Light-grey housing in RAL 7035
- Various approvals and marks



#### Main benefits

##### Adjustable output voltage

The CP-D range types > 10 W feature a continuously adjustable output voltage. Thus, they can be optimally adapted to the application, for example compensating the voltage drop caused by a long line length.

##### Wide range input

Optimized for world-wide applications: The CP-D power supplies can be supplied with 90-264 V AC or 120-375 V DC.

##### Width and structural form

With their width being only 18 to 90 mm, the CP-D range switch mode power supplies are ideally suited for installation in distribution panels.

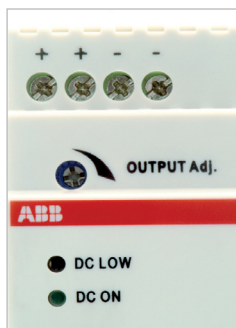

# CP-D range

## Operation controls

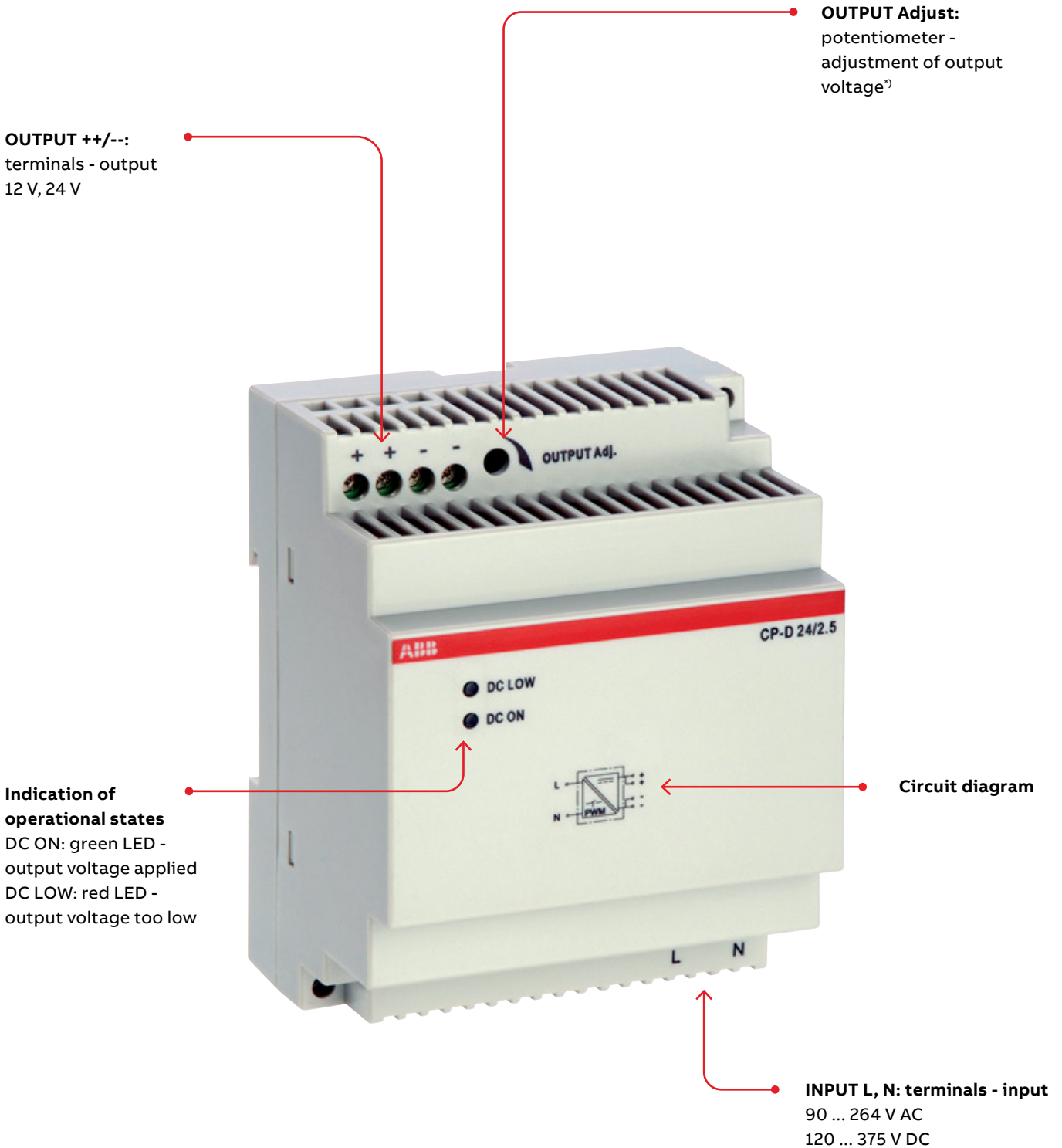

<sup>\*)</sup> only for devices > 10 W. 12 V version: 12...14 V DC, 24 V version: 24 ... 28 V DC.



# CP-D range Applications



Emergency lighting



Communication



Escalators



Elevators



LED lighting

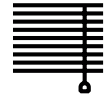

Venetian blind drives



## CP-D range

### Ordering details



CP-D 12/0.83, CP-D 24/0.42



CP-D 12/2.1, CP-D 24/1.3



CP-D 24/2.5

### Description

The CP-D range of modular power supply units in MDRC design (modular DIN rail components) is ideally suited for installation in distribution panels. This range offers devices with output voltages of 12 V DC and 24 V DC at output currents of 0.42 A to 4.2 A. Thanks to their high thermal efficiency, these power supplies have very low power and heat dissipation and can be operated without forced cooling. All power supply units in the CP-D range are approved according to all relevant international standards.



### Ordering details

Input voltage range	Rated output voltage / current	Type	Order code	Weight (1 pc.) kg (lb)
90-264 V AC/ 120-375 V DC	12 V DC / 0.83 A	CP-D 12/0.83	1SVR427041R1000	0.06 (0.13)
90-264 V AC/ 120-375 V DC	12 V DC / 2.1 A	CP-D 12/2.1	1SVR427043R1200	0.19 (0.41)
90-264 V AC/ 120-375 V DC	24 V DC / 0.42 A	CP-D 24/0.42	1SVR427041R0000	0.06 (0.13)
90-264 V AC/ 120-375 V DC	24 V DC / 1.3 A	CP-D 24/1.3	1SVR427043R0100	0.19 (0.41)
90-264 V AC/ 120-375 V DC	24 V DC / 2.5 A	CP-D 24/2.5	1SVR427044R0200	0.25 (0.56)
90-264 V AC/ 120-375 V DC	24 V DC / 4.2 A	CP-D 24/4.2	1SVR427045R0400	0.32 (0.71)

## CP-D range

### Technical data

Data at  $T_a = 25\text{ °C}$ ,  $U_{in} = 230\text{ V AC}$  and rated values, unless otherwise indicated

Type	CP-D 12/0.83	CP-D 12/2.1
<b>Input circuit - supply circuit</b>	<b>L, N</b>	
Rated input voltage $U_{in}$	100-240 V AC	
Input voltage range	90-264 V AC / 120-375 V DC	
Frequency range AC	47-63 Hz	
Typical input current / typical power consumption	at 115 V AC 200 mA / 12.68 W	502 mA / 31.14 W
	at 230 V AC 128.3 mA / 13.01 W	277 mA / 31.2 W
Inrush current	at 115 / 230 V AC 16 A / 32 A	
Power failure buffering time	min. 30 ms	
Internal input fuse	1 A slow-acting / 250 V AC	2 A slow-acting / 250 V AC
Power factor correction (PFC)	no	
<b>Indication of operational states</b>		
Output voltage	DC ON: green LED  : output voltage applied	
	DC LOW: red LED  : output voltage too low	
<b>Output circuit</b>	<b>+, -</b>	<b>++, --</b>
Rated output voltage	12 V DC	
Tolerance of the output voltage	±1 %	
Adjustment range of the output voltage	-	12-14 V DC
Rated output power	10 W	25 W
Rated output current $I_r$	$T_a \leq 60\text{ °C}$ 0.83 A	2.1 A
Derating of the output current	$60\text{ °C} < T_a \leq 70\text{ °C}$ 2.5 %/°C	
Maximum load change statical deviation with change of output voltage within the input voltage range	max. 1 %	
Recover time $T_A$	< 1 ms	
Starting time after applying the supply voltage	at $I_r$ 1000 ms	
Rise time	at rated load typ. 1 ms	
Residual ripple and switching peaks	BW = 20 MHz 50 mV	
Parallel connection	yes, using CP-D RU	
Series connection	yes, to increase voltage	
Resistance to reverse feed	18 V / 1 s	
<b>Output circuit - No-load, overload and short-circuit behavior</b>		
Characteristic curve of output	hiccup-mode	U/I characteristic curve
Short-circuit protection	continuous short-circuit stability	
Short-circuit behavior	continuation with output power limiting	
Current limiting at short circuit	typ. 1.4 A	typ. 5.9 A
Overload protection	output power limiting	
Overvoltage protection	15-16.5 V DC	
No-load protection	continuous no-load stability	
Starting of capacitive loads	unlimited	
<b>General data</b>		
Efficiency	typ. 78 %	typ. 82 %
Duty cycle	100 %	
Dimensions	see "Dimensional drawings"	
Material of housing	plastic	
Mounting	DIN rail (IEC/EN 60715), snap-on mounting without any tool	
Mounting position	horizontal	
Minimum distance to other units	horizontal / vertical	25 mm / 25 mm (0.98 in / 0.98 in)
Degree of protection	housing / terminals	IP20 / IP20
Protection class	II	

## CP-D range

### Technical data

Data at  $T_a = 25\text{ °C}$ ,  $U_{in} = 230\text{ V AC}$  and rated values, unless otherwise indicated

Type		CP-D 12/0.83	CP-D 12/2.1
<b>Electrical connection - Input circuit / Output circuit</b>			
Connecting capacity	fine-strand with wire end ferrule	0.2-1.5 mm <sup>2</sup> (24-16 AWG)	0.2-2.5 mm <sup>2</sup> (24-14 AWG)
	rigid	0.2-2.5 mm <sup>2</sup> (26-12 AWG)	0.2-2.5 mm <sup>2</sup> (24-12 AWG)
Stripping length		4-5 mm (0.16-0.2 in)	7 mm (0.28 in)
Tightening torque		0.6 Nm (5 lb.in)	0.7 Nm (6 lb.in)
<b>Environmental data</b>			
Ambient temperature range	operation	-40...+70 °C (-40...+158 °F)	
	rated load	-40...+60 °C (-40...+131 °F)	
	storage	-40...+85 °C (-40...+185 °F)	
Altitude during operation	IEC/EN 60068-2-13	max. 4850 m	
Damp heat (cyclic) (IEC/EN 60068-2-30)		4 x 24 cycles, 40 °C, 95 % RH	
Vibration (sinusoidal) (IEC/EN 60068-2-6)		50 m/s <sup>2</sup> , 10 Hz - 2 kHz	
Shock (half-sine) (IEC/EN 60068-2-27)		40 m/s <sup>2</sup> , 22 ms	
<b>Isolation data</b>			
Rated insulation voltage $U_i$	input circuit / output circuit	3 kV AC	
Pollution degree		2	
Overvoltage category		II	
<b>Standards / Directives</b>			
Standards		IEC/EN 62368-1	
Low Voltage Directive		2014/35/EU	
EMC Directive		2014/30/EU	
RoHS Directive		2011/65/EU	
Protective low voltage		SELV (IEC 60950-1)	
<b>Electromagnetic compatibility</b>			
Interference immunity to		IEC/EN 61000-6-2	
electrostatic discharge	IEC/EN 61000-4-2	level 4 (4 kV / 8 kV)	level 4 (4 kV / 15 kV)
radiated, radio-frequency, electromagnetic field	IEC/EN 61000-4-3	level 3 (10 V/m)	
electrical fast transient/burst	IEC/EN 61000-4-4	level 4 (4 kV)	
surge	IEC/EN 61000-4-5	level 3 (2 kV L-L)	
conducted disturbances, induced by radio-frequency fields	IEC/EN 61000-4-6	level 3 (10 V)	
Interference emission		IEC/EN 61000-6-3	
high-frequency radiated		class B	
high-frequency conducted		class B	





## CP-D range

### Technical data

Data at  $T_a = 25\text{ °C}$ ,  $U_{in} = 230\text{ V AC}$  and rated values, unless otherwise indicated

Type		CP-D 24/0.42	CP-D 24/1.3	CP-D 24/2.5	CP-D 24/4.2
<b>Electrical connection - Input circuit / Output circuit</b>					
Connecting capacity	fine-strand with wire end ferrule	0.2-1.5 mm <sup>2</sup> (24-16 AWG)	0.2-2.5 mm <sup>2</sup> (24-14 AWG)		
	rigid	0.2-2.5 mm <sup>2</sup> (26-12 AWG)	0.2-2.5 mm <sup>2</sup> (24-12 AWG)		
Stripping length		4-5 mm (0.16-0.2 in)		7 mm (0.28 in)	
Tightening torque		0.6 Nm (5 lb.in)		0.7 Nm (6 lb.in)	
<b>Environmental data</b>					
Ambient temperature range	operation	-40...+70 °C			
	rated load	-40...+60 °C		-40...+55 °C	-40...+60 °C
	storage	-40...+85 °C			
Altitude during operation	IEC/EN 60068-2-13	max. 4850 m			
Damp heat (cyclic) (IEC/EN 60068-2-30)		4 x 24 cycles, 40 °C, 95 % RH			
Vibration (sinusoidal) (IEC/EN 60068-2-6)		50 m/s <sup>2</sup> , 10 Hz - 2 kHz			
Shock (half-sine) (IEC/EN 60068-2-27)		40 m/s <sup>2</sup> , 22 ms			
<b>Isolation data</b>					
Rated insulation voltage $U_i$	input circuit / output circuit	3 kV AC		4 kV AC	3 kV AC
Pollution degree		2			
Overvoltage category		II			
<b>Standards / Directives</b>					
Standards		IEC/EN 62368-1			
Low Voltage Directive		2014/35/EU			
EMC Directive		2014/30/EU			
RoHS Directive		2011/65/EU			
Protective low voltage		SELV (IEC 60950-1)			
<b>Electromagnetic compatibility</b>					
Interference immunity to		IEC/EN 61000-6-2			
electrostatic discharge	IEC/EN 61000-4-2	level 4 (4 kV / 8 kV)	level 4 (4 kV / 15 kV)		level 4 (4 kV / 8 kV)
		radiated, radio-frequency, electromagnetic field	IEC/EN 61000-4-3	level 3 (10 V/m)	
electrical fast transient/burst	IEC/EN 61000-4-4	level 4 (4 kV)			
surge	IEC/EN 61000-4-5	level 3 (2 kV L-L)			
conducted disturbances, induced by radio-frequency fields	IEC/EN 61000-4-6	level 3 (10 V)			
Interference emission		IEC/EN 61000-6-3			
high-frequency radiated		class B			
high-frequency conducted		class B			

# CP-D range

## Technical diagrams

### Characteristic curve of output at $T_a = 25^\circ\text{C}$

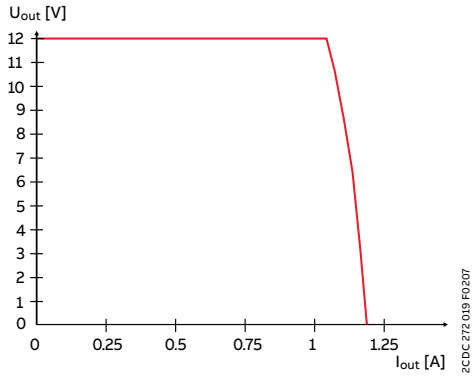

CP-D 12/0.83

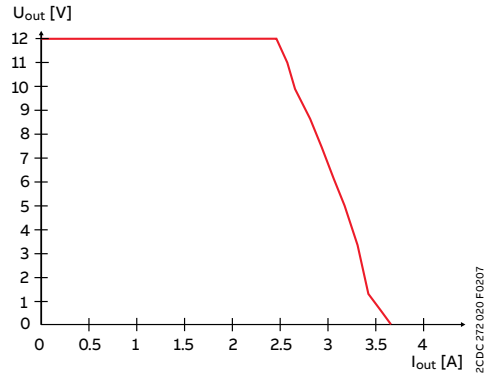

CP-D 12/2.1

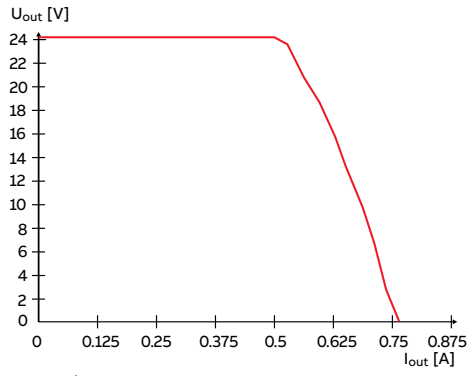

CP-D 24/0.42

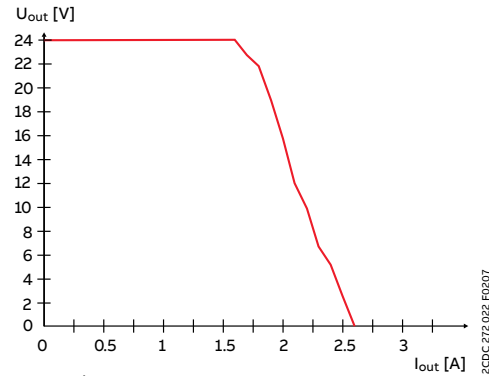

CP-D 24/1.3

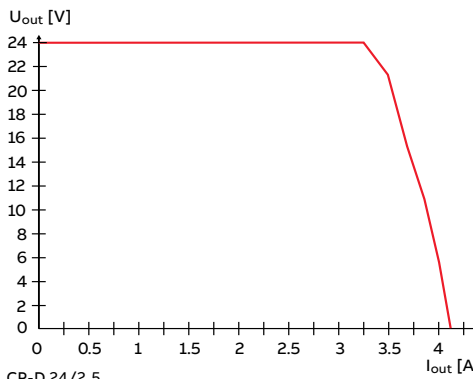

CP-D 24/2.5

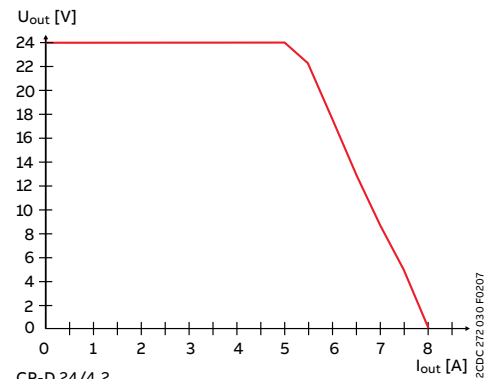

CP-D 24/4.2

### Characteristic curve of temperature at rated output voltage

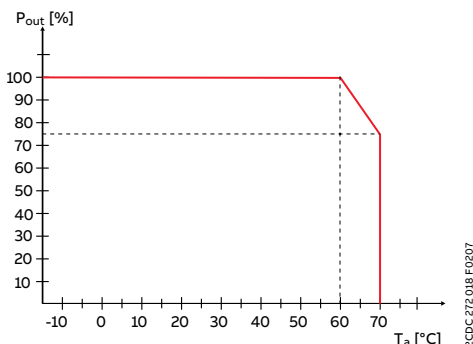

CP-D except CP-D 24/2.5

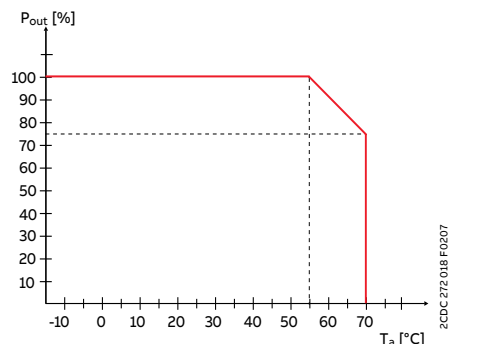

CP-D 24/2.5

# CP-D range

## Technical diagrams

### Dimensional drawings

Dimensions in mm and inches

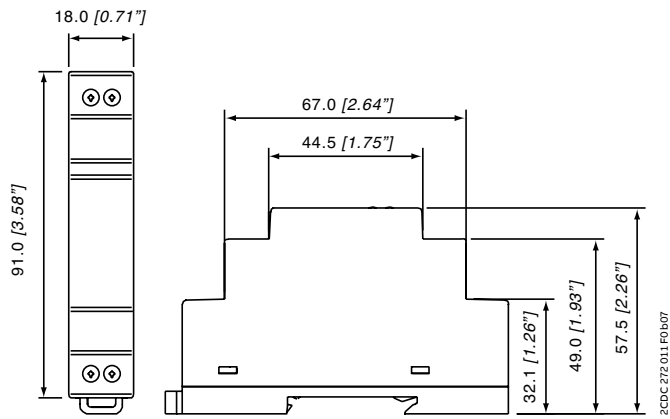

CP-D 12/0.83, CP-D 24/0.42

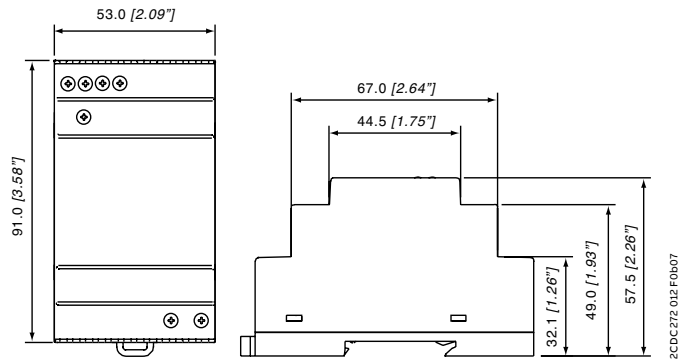

CP-D 12/2.1, CP-D 24/1.3

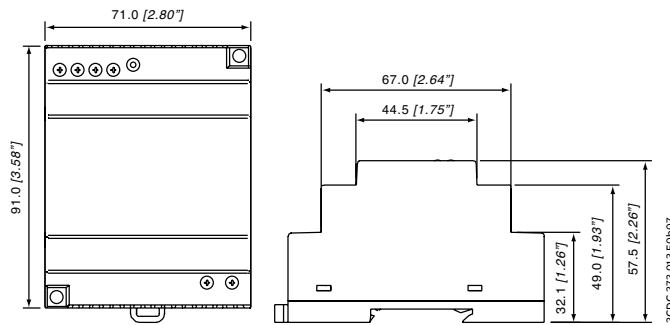

CP-D 24/2.5

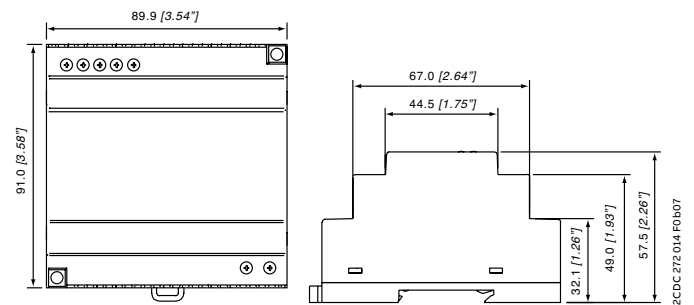

CP-D 24/4.2







---

## **CP-B range**

### Table of contents

<b>104</b>	<b>Benefits and advantages</b>
<b>106</b>	<b>Operation controls</b>
<b>107</b>	<b>Applications</b>
<b>108</b>	<b>Ordering details</b>
<b>109</b>	<b>Technical data</b>
<b>112</b>	<b>Technical diagrams</b>

## CP-B range

### Benefits and advantages



ABB's ultra-capacitor based CP-B buffer modules serve to ensure a short-term uninterrupted power supply system with a voltage of 24 V DC by buffering the load in case of power loss.

The buffer modules feature a technology for storing energy: the use of ultra-capacitors obviates the need for maintenance and exempts deep discharge in comparison to batteries.



**Continuous  
operation**

- Buffering 24 V DC supply of up to 572 s
- Maintenance-free, ultra-capacitor technology
- Temperature resistant
- No discharge
- Small footprint

# CP-B range

## Benefits and advantages

Power supply systems have to be highly reliable in most areas of energy management and automation technology. Often, batteries are used for supporting the supply system in case of mains failures. Batteries have limited lifetimes depending on environmental parameters and have to be maintained regularly, which causes extra work and costs.

Using the ultra-capacitor technology, ABB offers an innovative and completely maintenance-free new product for buffering the 24 V DC supply in case of interrupted mains on the primary side of the switch mode power supply.

The CP-B range is an ultra-capacitor buffer energy storage system for power supply units which ensures a short term uninterrupted power supply system. In case of power loss, the energy stored in the capacitor guarantees that the load is continually provided for up to several hundred seconds depending on the load current.



### Characteristics

- 3 buffer modules for buffering 24 V DC:
  - CP-B 24/3.0 (3 A / 1 kWh<sup>1)</sup>)
  - CP-B 24/10.0 (10 A / 13.7 kWh<sup>1)</sup>)
  - CP-B 24/20.0 (20 A / 8 kWh<sup>1)</sup>)
- LEDs for status indication
- Relay contacts for status messaging
- Very high backup times (e.g. with CP-B 24/10.0 up to 9 minutes and 30 s minutes at 1 A load current)
- Short charging times
- High efficiency, higher than 95 %
- Wide temperature range
- DIN rail mountable, compact housing
- Extended temperature range -40...60 °C

<sup>1)</sup> internal energy buffer

		CP-B 24/3.0	CP-B 24/10.0	CP-B 24/20.0
Order code		1SVR427060R0300	1SVR427060R1000	1SVR427060R2000
Rated input voltage		24 V DC	24 V DC	24 V DC
Rated current		3 A DC	10 A DC	20 A DC
Energy storage (min.)		1.000 Ws	13.700 Ws	8.000 Ws
Typical charging time at load current	100 %	65 s	134 s	135 s
	0 %	56 s	82 s	62 s
Typical buffering time <sup>1)</sup> at load current	100 %	13 s	50 s	15 s
	50 %	28 s	115 s	30 s
	25 %	66 s	246 s	60 s
	10 %	148 s	572 s	150 s

<sup>1)</sup> buffering time  $\approx \frac{\text{energy storage} \times 0.9}{\text{current} \times \text{output voltage}}$

# CP-B range

## Operation controls

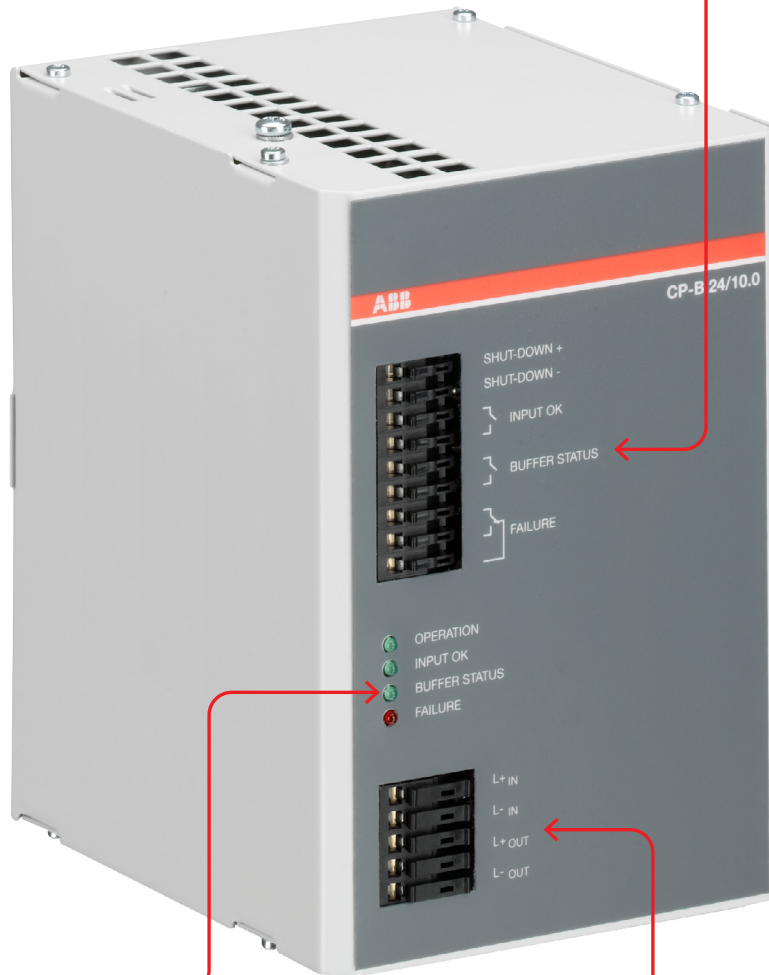

**Input terminals**  
 SHUT-DOWN+,  
 SHUT-DOWN-:  
 Input signal terminals  
 INPUT OK,  
 BUFFER STATUS,  
 FAILURE:  
 Signalling contact –  
 terminals  
 L+<sub>IN</sub>, L-<sub>IN</sub>: Input voltage  
 terminals

**Indication of operational states**  
 OPERATION:  
 Buffer module in operation  
 (standby or buffering)  
 INPUT OK:  
 Input voltage applied  
 BUFFER STATUS, FAILURE:  
 details see table 'LEDs,  
 status information and fault  
 messages' in data sheet

**Output terminals**  
 L+<sub>OUT</sub>, L-<sub>OUT</sub>, L-<sub>OUT</sub>:  
 Output voltage  
 terminals

# CP-B range Applications

## Example of application

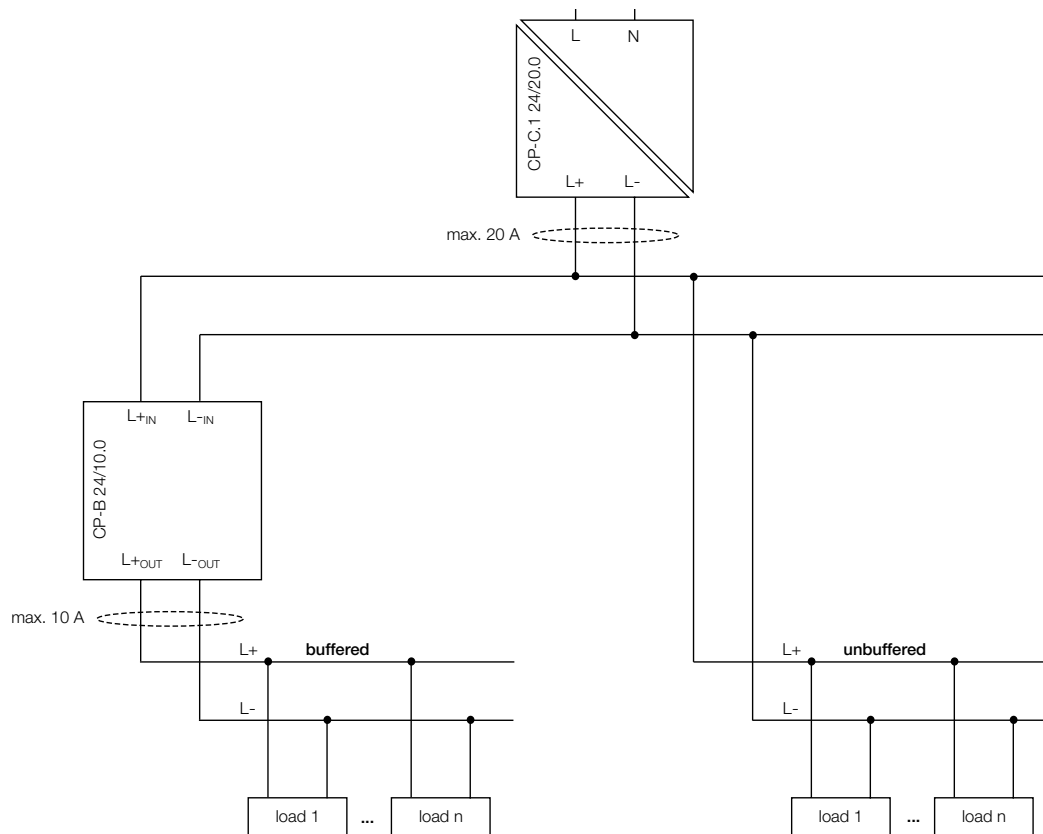



## CP-B range

### Ordering details



2CDC 271 004 50010

CP-B 24/3.0



2CDC 271 002 50010

CP-B 24/10.0



2CDC 271 003 50010

CP-B 24/20.0

### Description

Ultra capacitor based buffer units of the CP-B range offer the highest reliability also in harsh environments. Thanks to their ultra-cap based technology, the units are maintenance free, there will be no deep discharge and these products offer a very wide operational ambient temperature range. CP-B range buffer units are an excellent solution for avoiding voltage drops in solar applications, for example.

### Ordering details

Rated input voltage	Rated current	Type	Order code	Weight (1 pc.) kg (lb)
24 V DC	3 A DC	CP-B 24/3.0	1SVR427060R0300	0.59 (1.31)
	10 A DC	CP-B 24/10.0	1SVR427060R1000	2.10 (4.63)
	20 A DC	CP-B 24/20.0	1SVR427060R2000	2.20 (4.85)

## CP-B range

### Technical data

Type		CP-B 24/3.0	CP-B 24/10.0	CP-B 24/20.0
<b>Input circuit - Supply circuit</b>		<b>L<sub>IN</sub> L<sub>-IN</sub></b>		
Rated input voltage U <sub>in</sub>		24 V DC		
Input voltage range		23.7-26.4 V DC	23.9-27 V DC	23.4-29 V DC
Minimum charging potential		23.7 V DC	23.9 V DC	23.4 V DC
Rated input current		3 A DC	10 A DC	20 A DC
Inrush current limiting		50 A / 1 ms	35 A / 2 ms	35 A / 2 ms
Transient overvoltage protection		suppressor diode	varistor / suppressor diode	varistor / suppressor diode
Internal input fuse (apparatus protection, not accessible)		4 A slow acting	15 A (FK2)	30 A (FK2)
Internal fuse capacitors circuit (not accessible)			25 A (FK2)	
Kind of input	SHUT-DOWN	-	control input	control input
	rated voltage	-	24 V DC	24 V DC
	voltage range	-	6-45 V DC	6-45 V DC
<b>Output circuit</b>		<b>L<sub>OUT</sub> L<sub>-OUT</sub> L<sub>-OUT</sub></b>		
Rated output power		69 W	240 W	480 W
Rated output voltage U <sub>out</sub>		24 V DC		
Output voltage (buffer mode)		23.0 V DC	23.2 V DC	23.2 V DC
Tolerance of the output voltage		+2...-10 %		
Rated output current I <sub>r</sub>	T <sub>a</sub> ≤ 60 °C	3 A DC	10 A DC	20 A DC
Peak output current (fully loaded capacitors required)	T <sub>a</sub> ≤ 60 °C	6 A DC (min. 1.5 s)	20 A DC (10 A power supply + 10 A CP-B, min. 1.5 s)	40 A DC (min. 1.5 s)
Control of limiting current		-	10.3 A DC ±0.1A	-
Shut-down if limiting current is exceeded		-	after 1.5 s	-
Short-circuit protection (only via external fuse)		no continuous short-circuit stability		
Internal output fuse (not accessible)		-	15 A (FK2)	-
Required external fuse		3.15 A slow acting	10 A slow acting	25 A slow acting
Current limiting at output circuit		-	1.05...1.2 × I <sub>r</sub>	-
Breaking capacity of output circuit	t = 2.5 ms	-	24 V DC, 10 A	-
Power failure buffering time <sup>1)</sup>		load-dependent, min. 13 s at 100 % load	load-dependent, min. 50 s at 100 % load	load-dependent, min. 15 s at 100 % load
Overload protection		thermal protection		
Kind of output	INPUT OK	n/o contact		
	BUFFER STATUS	-	n/o contact	
	FAILURE	-	c/o contact	
Contact material		Ag + Au-clad		
Minimum switching voltage / Minimum switching current		5 V DC / 1 mA		
Maximum switching voltage / Maximum switching current		50 V AC / 1.0 A, 30 V DC / 0.5 A		
Mechanical lifetime		5 × 10 <sup>6</sup> switching cycles		
Electrical lifetime		0.1 × 10 <sup>6</sup> switching cycles		
Maximum fuse rating to achieve short-circuit protection	n/o or n/c contact	1.0 A AC / 0.5 A DC		

## CP-B range

### Technical data

Type		CP-B 24/3.0	CP-B 24/10.0	CP-B 24/20.0
<b>General data</b>				
Maximum internal power consumption		7 W	20 W	40 W
Power consumption with unloaded output		0.75 W	3 W	1.6 W
Energy storage (min.)		1000 Ws	13700 Ws	8000 Ws
Typical charging time at 24.5 V DC	100 %	65 s	134 s	135 s
	0 %	56 s	82 s	62 s
	Typical buffering time at load current <sup>1)</sup>	100 %	13 s	50 s
Typical buffering time at load current <sup>1)</sup>	50 %	28 s	115 s	30 s
	25 %	66 s	246 s	60 s
	10 %	148 s	572 s	150 s
	Efficiency	> 95 %		
Dimensions	see "Dimensional drawings"			
Material	cover / housing shell	steel sheet powdered		
Mounting		DIN rail (IEC/EN 60715), snap-on mounting		
Mounting position		horizontal		
Minimum distance to other units	horizontal	not necessary		
	vertical	40 mm (1.58 in)		80 mm (3.15 in)
Pollution degree		2		
Degree of protection	housing / terminal	IP20		
Protection class (IEC/EN 61140)		III SELV / PELV (condition: power supply fulfills class III)		
<b>Electrical connection - Input circuit / Output circuit</b>		<b>pull spring terminals</b>	<b>pull spring terminals</b>	<b>pluggable screw type terminals</b>
Connecting capacity	fine-strand with(out) wire end ferrule	0.08-1.0 mm <sup>2</sup> (28-18 AWG)	0.08-1.5 mm <sup>2</sup> (28-16 AWG)	0.2-4.0 mm <sup>2</sup> (24-12 AWG)
	rigid	0.08-1.5 mm <sup>2</sup> (28-16 AWG)	0.08-4.0 mm <sup>2</sup> (28-12 AWG)	0.2-6.0 mm <sup>2</sup> (24-10 AWG)
Stripping length		6.0 mm (0.24 in)		7.0 mm (0.28 in)
<b>Signaling circuit</b>				
Connecting capacity	fine-strand with(out) wire end ferrule	0.08-1.0 mm <sup>2</sup> (28-18 AWG)		0.14-1.0 mm <sup>2</sup> (26-16 AWG)
	rigid	0.08-1.5 mm <sup>2</sup> (28-16 AWG)		0.14-1.5 mm <sup>2</sup> (28-16 AWG)
Stripping length		6.0 mm (0.24 in)		7.0 mm (0.28 in)
<b>Environmental data</b>				
Ambient temperature	operation	-40...+60 °C		
	storage	-40...+60 °C		
<b>Standards / Directives</b>				
Standards		IEC/EN 62368-1, IEC/EN 61010-1, IEC/EN 62040-2		
Low Voltage Directive		2014/35/EU		
EMC Directive		2014/30/EU		
RoHS Directive		2011/65/EU		
<b>Electromagnetic compatibility</b>				
Interference immunity to		IEC/EN 61000-6-2		
electrostatic discharge	IEC/EN 61000-4-2	level 3, 6 kV / 8 kV		
radiated, radio-frequency, electromagnetic field	IEC/EN 61000-4-3	level 3, 10 V/m (27-1000 MHz) / level 2, 3 V/m (1400-2700 MHz)		
electrical fast transient/burst	IEC/EN 61000-4-4	level 3, 2(1) kV / 5 kHz		
surge	IEC/EN 61000-4-5	level 1, 0.5 kV		
conducted disturbances, induced by radio-frequency fields	IEC/EN 61000-4-6	level 3, 10 V (150 kHz-80 MHz)		
voltage dips, short interruptions and voltage variations	IEC/EN 61000-4-11	buffered by ultra-capacitors		
Interference emission		EN 61000-6-4		
high-frequency radiated	DIN EN 55011	B/C1		
high-frequency conducted	DIN EN 55011	B/C1		

<sup>1)</sup> buffering time  $\approx \frac{\text{energy storage} \times 0.9}{\text{current} \times \text{output voltage}}$

# CP-B range

## Technical diagrams

Characteristic curve of the temperature at rated load

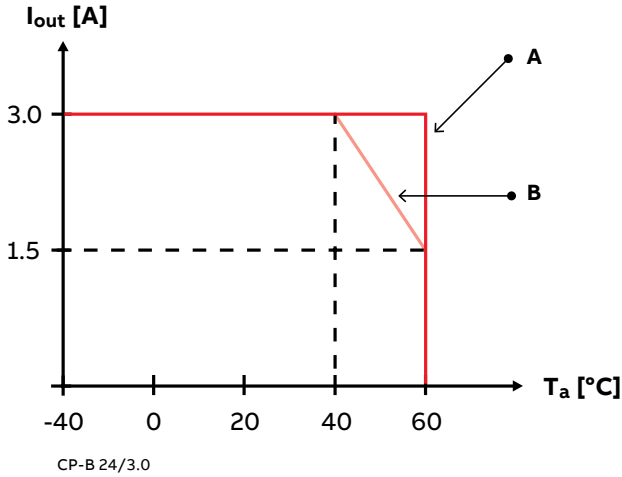

Capacitors life span over temperature

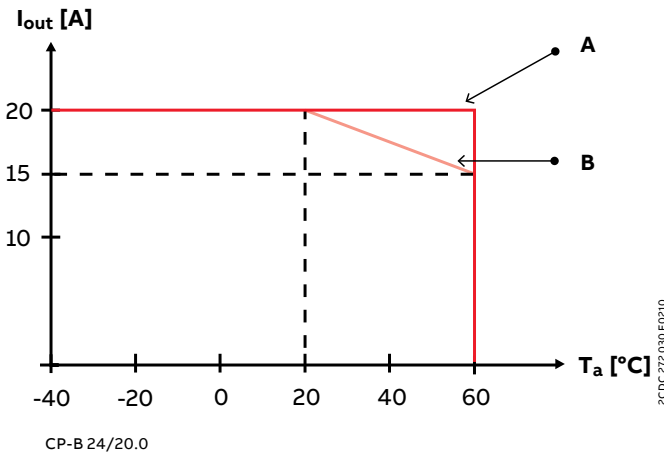
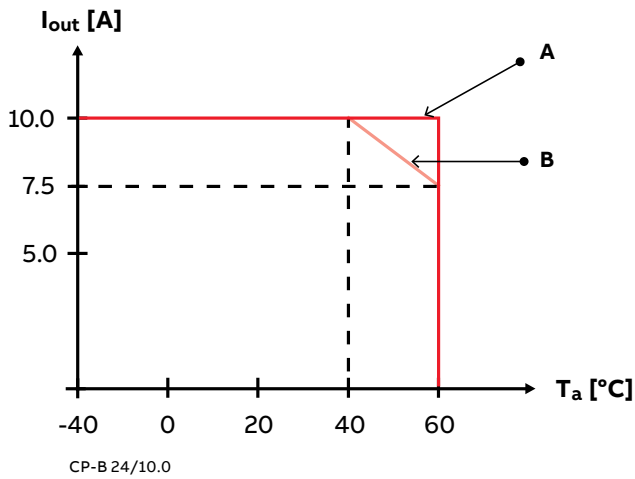
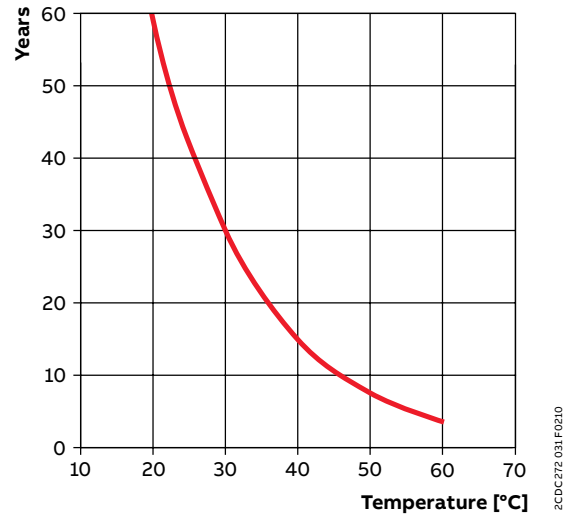

- A Normal application (up to 50 % buffer mode, 5 charging and discharging cycles in direct series)
- B Continuous charging and discharging in direct series. As this is not typical of a real application, this should be considered as theoretical indication

# CP-B range

## Technical diagrams

### Dimensional drawings

Dimensions in mm and inches

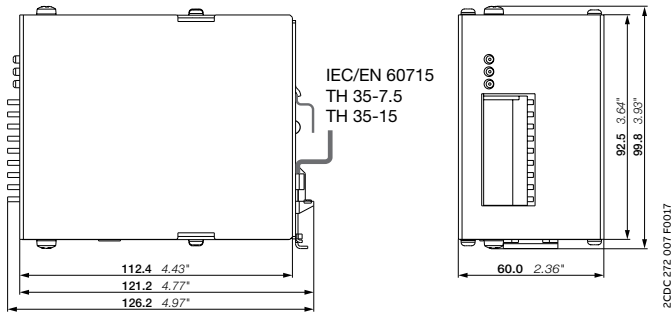

CP-B 24/3.0

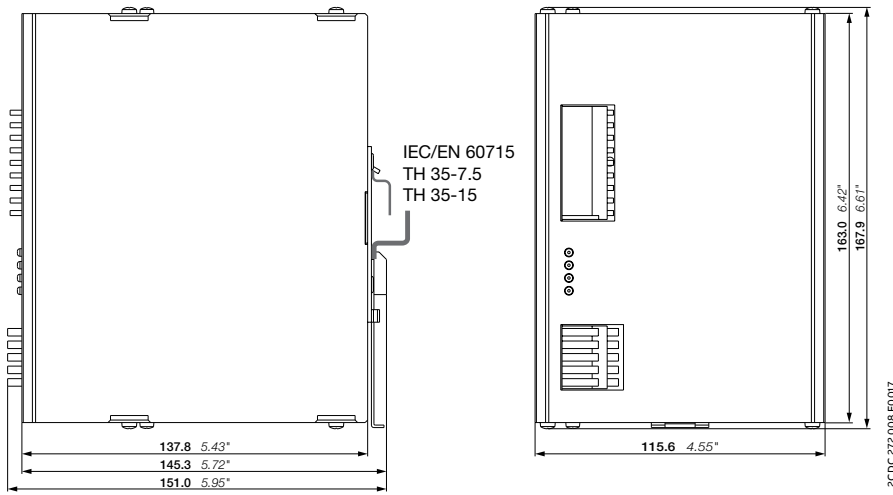

CP-B 24/10.0

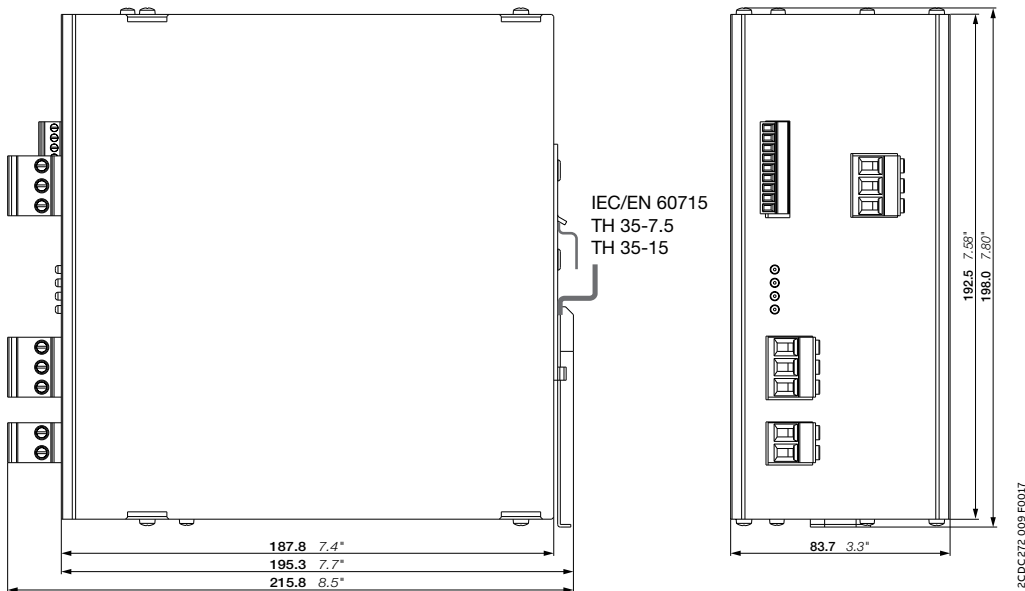

CP-B 24/20.0







---

## **Redundancy units**

### Table of contents

<b>117</b>	<b>Benefits and advantages</b>
<b>118</b>	<b>Ordering details</b>
<b>119</b>	<b>Technical data</b>
<b>122</b>	<b>Technical diagrams</b>



—  
**Establish true redundancy  
where it really matters with  
ABB's power supply  
redundancy units.**





## Redundancy units

### Benefits and advantages



ABB's redundancy units are used to establish true redundancy, which increases the availability of electrical systems significantly. Three versions are available with different output currents and power supply housings:

- CP-D RU in MDRC housing
- CP-C.1-A-RU for a true redundant setup of two 56 V DC power supplies of the CP range



**Continuous  
operation**

#### **Highest system reliability**

- Redundancy setup of the application possible to allow parallel operation
- Long lifetime

# Redundancy units

## Ordering details



CP-C.1-A-RU



CP-C.1-A-RU-L



CP-D RU

### Description

Whenever the highest availability and reliability are key requirements, a true redundancy setup with two power supplies connected to a redundancy unit is the best solution. In case one power supply fails, the other one keeps supplying the load. Furthermore, even a short circuit in one power supply will not affect the other one, which keeps supplying the load. The CP-C.1-A-RU is also available with coated PCBA (CP-C.1-A-RU-C) for harsh environments.

### Ordering details - CP-C.1-A-RU for decoupling of CP power supplies up to 20 A per input / channel

Input voltage range	Rated input current per channel	Rated output voltage / current		Type	Order code	Weight (1 pc.) kg (lb)
10 - 58 V DC	20 A	12 - 48 V DC / 2 x 20 A or 1 x 40 A	uncoated	CP-C.1-A-RU	1SVR360060R1001	1.04 (2.29)
			coated	CP-C.1-A-RU-C	1SVR360060R2001	1.04 (2.29)
			uncoated	CP-C.1-A-RU-L	1SVR361060R1001	1.04 (2.29)

### Ordering details - CP-D RU for decoupling of two CP-D power supply units

Input voltage range	Rated input current per channel	Rated output voltage / current	Type	Order code	Weight (1 pc.) kg (lb)
9-35 V DC	5 A	24 V DC / 1 x 10 A	CP-D RU	1SVR427049R0000	0.075 (0.165)



## Redundancy units

### Technical data

Data at  $T_a = 25\text{ °C}$ ,  $U_{in} = 230\text{ V AC}$  and rated values, unless otherwise indicated

Type		CP-C.1-A-RU, CP-C.1-A-RU-L	CP-C.1-A-RU-C
<b>Input circuit - Supply circuit</b>		<b>(+/, -/-)</b>	
Rated input voltage $U_{in}$		12-48 V DC	
Input voltage range		10 - 58 V DC	
Rated input current $I_{in}$ per channel	$-25\text{ °C} \leq T_a \leq 60\text{ °C}$	20 A	
Maximum input current per channel	$-25\text{ °C} \leq T_a \leq 40\text{ °C}$	30 A	
	$-40\text{ °C} \leq T_a \leq 40\text{ °C}$	-	30 A
Transient overvoltage protection		yes, varistor	
<b>Output circuit</b>		<b>(+/-)</b>	
Rated output voltage $U_{out}$		12 - 48 V DC	
Voltage drop input/output		typ. 0.6 V, max. 0.9 V	
Rated output current $I_o$	$-25\text{ °C} \leq T_a \leq 60\text{ °C}$	2 x 20 A or 1 x 40 A	
Max. output current (Power reserve)	$-25\text{ °C} \leq T_a \leq 40\text{ °C}$	2 x 30 A or 1 x 60 A	
	$-40\text{ °C} \leq T_a \leq 40\text{ °C}$	-	2 x 30 A or 1 x 60 A
Derating of the output current	$60\text{ °C} < T_a \leq 70\text{ °C}$	2.5 % per Kelvin temperature increase	
Resistance to reverse feed		< 60 V	
<b>General data</b>			
Power loss	input 2 x 20 A	23.0 W	
	input 2 x 10 A	9.4 W	
	input 2 x 5 A	4.1 W	
MTBF	acc. to MIL 217 HDBK	on request	
Dimensions		see "Dimensional drawings"	
Material of housing	cover / housing shell / front	aluminium / zinc-coated sheet steel / plastic	
Mounting		DIN rail (IEC/EN 60715), snap-on mounting	
Mounting position		1 and 7	
Minimum distance to other units	horizontal / vertical	25 mm (0.98 in) / 25 mm (0.98 in)	
Degree of protection (IEC/EN 60529)	housing / terminals	IP20 / IP20	
Protection class (IEC/EN 61140)		III	
<b>Electrical connection - Input circuit / Output circuit</b>			
Connecting capacity	fine-strand with(out) wire end ferrule	2.5-10 mm <sup>2</sup> (12-8 AWG)	
	rigid	2.5-16 mm <sup>2</sup> (12-6 AWG)	
Stripping length		10 mm (0.39 in)	
Tightening torque		1.2 Nm (10.5 lb.in)	
Recommended screw driver		PH1 / Ø 4.0 x 0.8 mm (0.16 x 0.03 in)	

## Redundancy units

### Technical data

Type		CP-C.1-A-RU, CP-C.1-A-RU-L	CP-C.1-A-RU-C
<b>Environmental data</b>			
Ambient temperature range	operation	-25...+70 °C (-13... +158 °F)	-40...+70 °C (-40...+158 °F)
	rated load	-25...+60 °C (-13... +140 °F)	-40...+60 °C (-40...+140 °F)
	storage	-40...+85 °C (-40...+185 °F)	
	transportation	-40...+85 °C (-40...+185 °F)	
Climatic class (IEC/EN 60721-3-1)	storage	1K2	
Climatic class (IEC/EN 60721-3-2)	transportation	2K2	
Climatic class (IEC/EN 60721-3-3)	operation	3K3	
Damp heat, cyclic (IEC/EN 60068-2-30)		test Db: 55 °C, 2 cycles	
Vibration (IEC/EN 60068-2-6)		test Fc: 10-58 Hz, amplitude ±0.15 mm, 58-150 Hz, 2 g, 10 sweep cycles each axis	
Shock, half-sine (IEC/EN 60068-2-27)		test Ea: 30 g, 6 ms, 3 pulses each axis; bump 20 g, 11 ms, 100 pulses each axis	
Coated PCBA		no	yes
Gaseous corrosive environment withstand test (IEC/EN 60068-2-60)		-	testing method: 4 testing period: 21 days ambient conditions: 25 °C, 75 % r.h. air/volume change rate per hour: 3-6 sample not energized during exposure gas concentrations acc. ISA-S71.04.2013 Harsh Group A, G3 IEC 60721-3.3 acc. 3C2/3C3 - H <sub>2</sub> S ≥ 100 ± 10 ppb - SO <sub>2</sub> /SO <sub>3</sub> ≥ 300 ± 20 ppb - Cl <sub>2</sub> ≥ 100 ± 10 ppb - NO <sub>x</sub> ≥ 1250 ± 20 ppb
<b>Isolation data</b>			
Rated impulse withstand voltage U <sub>imp</sub> (EN62477-1)	input / housing	1.5 kV (1.2/50 μs)	
	output / housing	1.5 kV (1.2/50 μs)	
Pollution degree		2	
<b>Standards / Directives</b>			
Standards		IEC/EN 61204	
EMC Directive		2014/30/EU	
ATEX Directive		-	2014/34/EU
RoHS Directive		2011/65/EU	
Electrical safety		IEC/EN 61010-1, IEC/EN 61010-2-201, IEC 60950-1	
Process control equipment		UL 61010-1, UL 61010-2-201/CAN/CSA C22.2 No. 61010-1-12, CAN/CSA-IEC 61010-2-201:18	
<b>Electromagnetic compatibility</b>			
Interference immunity to			
electrostatic discharge	IEC/EN 61000-4-2	Level 4, contact discharge ±8 kV, air discharge ±15 kV (criterion B)	
electrical fast transient / burst	IEC/EN 61000-4-4	Level 3, DC mains inputs and output ±2 kV (criterion B)	
surge	IEC/EN 61000-4-5	Level 1, DC mains inputs and output ±0.5 kV, input and output vs. PE ±1 kV (criterion B)	

## Redundancy units

### Technical data

<b>Type</b>	<b>CP-D RU</b>	
<b>Input circuit - Supply circuit</b>	<b>IN 1 + + -, IN 2 + + -</b>	
Rated input voltage $U_{in}$	24 V DC	
Input voltage range	9-35 V DC	
Rated input current $I_{in}$ per channel	5 A	
Maximum input current per channel	10 A for 300 s	
Transient overvoltage protection	no	
<b>Output circuit</b>	<b>OUT + + +, - - -</b>	
Rated output voltage $U_{out}$	24 V DC	
Voltage drop	typ. 0.5 V	
Rated output current $I_{out}$	10 A	
Resistance to reverse feed	< 35 V	
<b>General data</b>		
MTBF	on request	
Duty cycle	100 %	
Dimensions	see "Dimensional drawings"	
Material of housing	plastic	
Mounting	DIN rail, snap-on mounting without any tool	
Mounting position	1, 7	
Minimum distance to other units	horizontal / vertical	25 mm (0.98 in) / 25 mm (0.98 in)
<b>Electrical connection - Input circuit / Output circuit</b>		
Connecting capacity	fine-strand with (out)wire end ferrule	0.2-2.5 mm <sup>2</sup> (24-14 AWG)
	rigid	0.2-2.5 mm <sup>2</sup> (24-12 AWG)
Stripping length	7.0 mm (0.28 in)	
Tightening torque	0.67 Nm (6 lb.in)	
<b>Environmental data</b>		
Ambient temperature range	operation	-40...+70 °C
	storage	-40...+85 °C
Relative humidity	RH at 40 °C	20-95 %, no condensation
Vibration (IEC/EN 60068-2-6)	mounting by rail: 10-500 Hz, 2 G, along X, Y, Z each axis, 60 min for each axis	
Shock (IEC/EN 60068-2-27)	15 G, 11 ms, 3 axis, 6 faces, 3 times for each face	
<b>Standards / Directives</b>		
Standards	IEC/EN 62368-1, IEC/EN 61204-3	
RoHS Directive	2011/65/EU	
<b>Electromagnetic compatibility</b>		
Interference immunity to	EN 55024	
electrostatic discharge	IEC/EN 61000-4-2	level 3, air discharge 8 kV, contact discharge 4 kV
radiated, radio-frequency, electromagnetic field	IEC/EN 61000-4-3	level 3, 10 V/m
electrical fast transient/burst	IEC/EN 61000-4-4	level 3, 2 kV / 5 kHz
conducted disturbances, induced by radio-frequency fields	IEC/EN 61000-4-6	level 3, 10 V
Interference emission	EN 55032	
high-frequency radiated	IEC/CISPR 32 / EN 55032	class B
high-frequency conducted	IEC/CISPR 32 / EN 55032	class B

# Redundancy units

## Technical diagrams

### Dimensional drawings

Dimensions in mm and inches

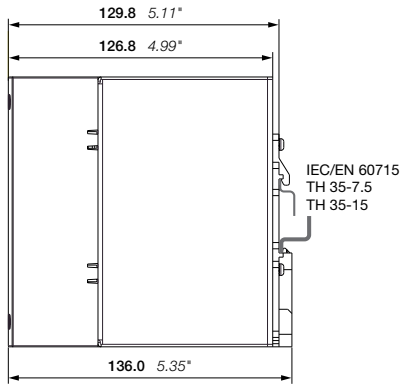

CP-C.1-A-RU, CP-C.1-A-RU-L  
CP-C.1-A-RU-C

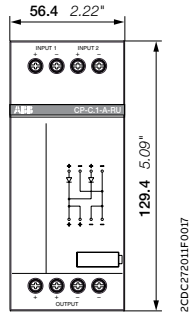

2CDC272011F0017

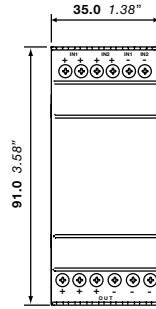

CP-D RU

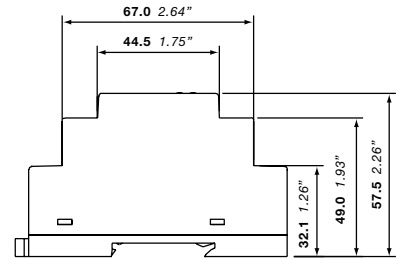

2CDC272033F0010





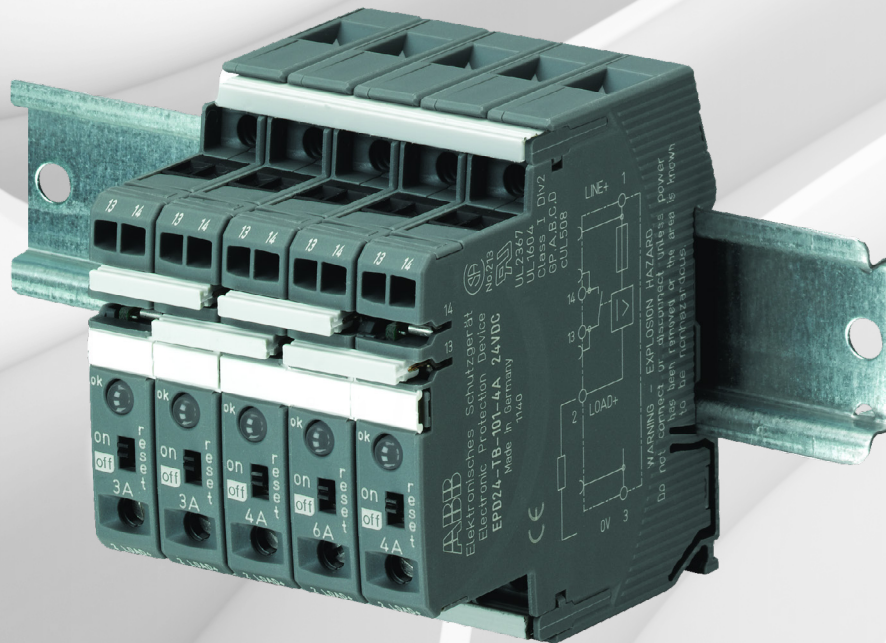

---

# Electronic protection devices EPD24

## Table of contents

<b>126</b>	<b>Benefits and advantages</b>
<b>127</b>	<b>Applications</b>
<b>128</b>	<b>Ordering details</b>
<b>129</b>	<b>Operating data</b>
<b>130</b>	<b>Technical data</b>
<b>131</b>	<b>Technical information</b>
<b>132</b>	<b>Technical diagrams</b>
<b>133</b>	<b>Approvals, Safety instructions</b>
<b>134</b>	<b>Installation guidelines</b>

# Electronic protection devices EPD24

## Benefits and advantages

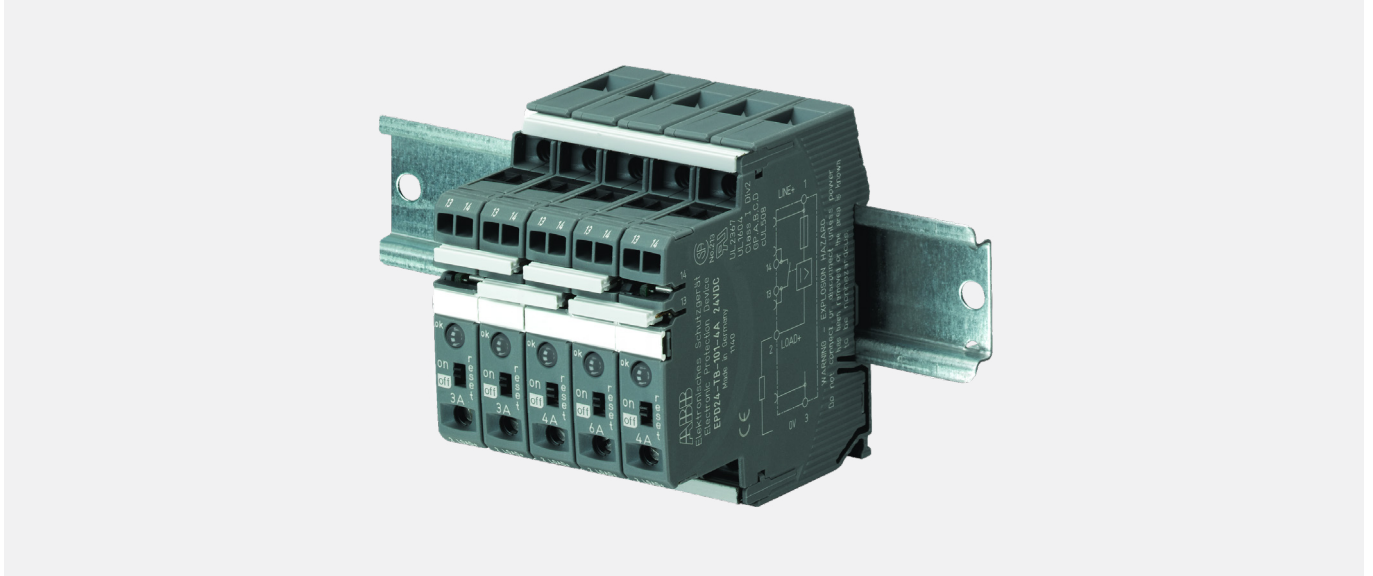

With its narrow width of only 12.5 mm, EPD24 can fit everywhere – it can even be mounted side-by-side.

Its adjustable and fixed current ratings, projectable protection through current limitation as well as a single trip curve for all types of loads allow for use in a wide field of applications.



**Continuous  
operation**

### Highlights

- Safety and reliability
- Operational continuity
- Worldwide use thanks to relevant certifications
- Compact and effective



# Electronic protection devices EPD24

## Applications



### Features

- Selective load protection, one electronic tripping characteristic.
- Active current limitation for safe connection of capacitive loads up to 20,000  $\mu\text{F}$  and on overload/short circuit
- Current ratings 0.5...12 A
- Reliable overload disconnection with  $1.1 \times I_N$
- Manual ON/OFF button
- Clear status and failure indication through LED and integrated auxiliary contact
- Integral fail-safe element adjusted to current rating
- Width per unit only 12.5 mm
- Rail mounting
- Ease of wiring through busbar LINE+ and 0 V as well as signal bars
- UL- and CSA-approvals allow international use of the devices



### Applications

- Packaging machines
- Automation
- Automation & Process Control
- Automotive Manufacturing
- Chemical, Oil & Gas
- Medical Equipment
- Pharmaceutical & Food
- Power Engineering DC 24 V
- Renewable Energy
- Steel Production



## Electronic protection devices EPD24

### Ordering details

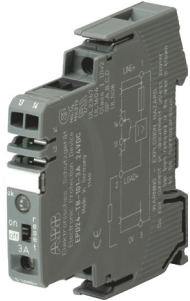

EPD24-TB-101-3A

2CDC 051 001 50010

#### Description

The protection devices EPD24 extend the ABB product range of modular DIN rail components by electronic overcurrent protection modules for selective protection of 24 V DC load circuits. This protection is achieved by a combination of active electronic current limitation in the case of a short circuit and an overload deactivation from  $1.1 \times I_n$  upwards.

If a fault occurs in a load circuit, the protection device EPD24 will detect this rapidly and reliably, then disable the power output transistor and hence interrupt the current flow in the defective circuit. The maximum possible overcurrent is always limited to 1.3...1.8 times the selected rated current. An activation of capacitive loads up to 20,000  $\mu\text{F}$  is possible, deactivation only occurring in the case of overloads or short circuits. Selective deactivation of the defective current circuit means undefined error states and a complete system stop are prevented.

#### Ordering details

Rated current $I_n$	Type	Order code	Pkg qty	Weight (1 pc.) kg (lb)
<b>A</b>				
0.5	EPD24-TB-101-0.5A	2CDE601101R2905	4	0.065 (1.433)
1	EPD24-TB-101-1A	2CDE601101R2001	4	0.065 (1.433)
2	EPD24-TB-101-2A	2CDE601101R2002	4	0.065 (1.433)
3	EPD24-TB-101-3A	2CDE601101R2003	4	0.065 (1.433)
4	EPD24-TB-101-4A	2CDE601101R2004	4	0.065 (1.433)
6	EPD24-TB-101-6A	2CDE601101R2006	4	0.065 (1.433)
8	EPD24-TB-101-8A	2CDE601101R2008	4	0.065 (1.433)
10	EPD24-TB-101-10A	2CDE601101R2010	4	0.065 (1.433)
12	EPD24-TB-101-12A	2CDE601101R2012	4	0.065 (1.433)

Description	Type	Order code	Pkg qty	Weight (1 pc.) kg (lb)
Busbars for LINE+ and 0 V, grey insulation, length 500 mm <sup>1)</sup>	EPD-BB500	2CDE605100R0500	10	0.2 (0.441)
Signal bars for aux. contacts, grey insulation, length 21 mm	EPD-SB21	2CDE605200R0021	10	0.4 (0.882)

<sup>1)</sup> Max. load with one line entry  $I_{\text{max}} = 50 \text{ A}$  (recommended: mid line entry)  
Max. load with two line entries  $I_{\text{max}} = 63 \text{ A}$

## Electronic protection devices EPD24

### Operating data

<b>Operating data</b>	
Operating voltage $U_b$	24 V DC (18...32 V)
Current rating $I_N$	fixed current ratings: 0.5, 1, 2, 3, 4, 6, 8, 10, 12 A
Closed current $I_o$	ON condition: typically 20...30 mA depending on signal output
Status indication by means of	Green: unit is ON load circuit / Power-MOSFET is switched on Orange: in the event of overload or short circuit until electronic disconnection Red: unit electronically disconnected load circuit/Power-MOSFET OFF undervoltage ( $U_b < 8$ V) after switch-on till the end of the delay period OFF: manually switched off or device is dead potential-free auxiliary contact F ON/OFF/ condition of switch
<b>Load circuit</b>	
Load output	Power-MOSFET switching output (high side switch)
Overload disconnection	typically $1.1 \times I_N$ (1.05...1.35 $\times I_N$ )
Short-circuit current $I_k$	active current limitation
Trip time	see time/current characteristics
For electronic disconnection	typically 3 s at $I_{Load} > 1.1 \times I_N$ typically 100 ms...3 s at $I_{Load} > 1.8 \times I_N$ (or $1.5 \times I_N/1.3 \times I_N$ )
Temperature disconnection	internal temperature monitoring with electronic disconnection
Low voltage monitoring load output	with hysteresis, no reset required: load »OFF« at $U_b < 8$ V
Starting delay $t_{Start}$	typically 0.5 sec after every switch-on and after applying $U_b$
Disconnection of load circuit	electronic disconnection
Free-wheeling circuit	suitable external free-wheeling circuit to be used with inductive load
Several load outputs must not be connected in parallel	
<b>Signal output</b>	
Electrical data	potential-free auxiliary contact max. 30 V DC/0.5 A, min. 10 V DC/10 mA
ON condition LED green	voltage $U_b$ applied, switch is in ON position no overload, no short circuit
OFF condition LED off	device switched off (switch is in OFF position) no voltage $U_b$ applied
Fault condition LED orange	overload condition $> 1.1 \times I_N$ up to electronic disconnection
Fault condition LED red	electronic disconnection upon overload or short circuit Device switched off with control signal (switch is in ON position)
Aux. contact	single signal, make contact contact open, terminal 13-14
Fault	signal output fault conditions no operating voltage $U_b$ ON/OFF switch is in OFF position red LED lighted (electronic disconnection)



## Electronic protection devices EPD24

### Technical data

General data	
Fail-Safe element	backup fuse for EPD24 not required because of the integral redundant fail-safe element
Housing material	moulded
Mounting	symmetrical rail to EN 50022-35x7.5
Ambient temperature	0...+50 °C (without condensation, see EN 60204-1)
Storage temperature	-20...+70 °C
Humidity	96 hrs/95 % RH/40 °C to IEC 60068-2-78, test Cab. climate class 3K3 to EN 60721
Vibration	3 g, test to IEC 60068-2-6 test Fc
Degree of protection	housing: IP20 DIN 40050 terminals: IP20 DIN 40050
EMC (EMC directive, CE logo)	emission: EN 61000-6-3 susceptibility: EN 61000-6-2
Isolations coordination (IEC 60934)	0.5 kV/pollution degree 2 reinforced insulation in operating area
Dielectric strength	max. 32 V DC (load circuit)
Isolation resistance (OFF condition)	n/a, only electronic disconnection
Approvals/Declarations of conformity	UL 2367 Solid State Overcurrent Protectors UL 1604, (class I, division 2, groups A, B, C, D) UL 508 CSA C22.2 No. 213 (class I, division 2) CSA C22.2 No. 142 CE logo
Dimensions (B x H x T)	12.5 x 80 x 83 mm
Weight	approx. 65 g
Terminals	
<b>Line+/LOAD+/0V</b>	
Screw terminals	M4
Max. cable cross section flexible with wire end ferrule w/wo plastic sleeve	0.5 – 10 mm <sup>2</sup>
Multi-lead connection (2 identical cables) rigid/flexible	0.5 – 4 mm <sup>2</sup>
Flexible with wire end ferrule without plastic sleeve	0.5 – 2.5 mm <sup>2</sup>
Flexible with TWIN wire end ferrule with plastic sleeve	0.5 – 6 mm <sup>2</sup>
Wire stripping length	10 mm
Tightening torque (EN 60934)	1.5 – 1.8 Nm
Terminals	
<b>aux. contacts</b>	
Screw terminals	M3
Max. cable cross section flexible with wire end ferrule w/wo plastic sleeve	0.25 - 2.5 mm <sup>2</sup>
Wire stripping length	8 mm
Tightening torque (EN 60934)	0.5 Nm

**Table 1: voltage drop, current limitation, max. load current**

current rating $I_N$	typically voltage drop $U_{ON}$ at $I_N$	active current limitation (typically)	max. load current at 100 % ON duty	
			$T_{ambient} = 40\text{ °C}$	$T_{ambient} = 40\text{ °C}$
0.5 A	70 mV	$1.8 \times I_N$	0.5 A	0.5 A
1 A	80 mV	$1.8 \times I_N$	1 A	1 A
2 A	130 mV	$1.8 \times I_N$	2 A	2 A
3 A	80 mV	$1.8 \times I_N$	3 A	3 A
4 A	100 mV	$1.8 \times I_N$	4 A	4 A
6 A	130 mV	$1.8 \times I_N$	6 A	5 A
8 A	120 mV	$1.5 \times I_N$	8 A	7 A
10 A	150 mV	$1.5 \times I_N$	10 A	9 A
12 A	180 mV	$1.3 \times I_N$	12 A	10.8 A

Attention: when mounted side-by-side without convection, the ERD24 should carry no more than 80 % of its rated load with 100 % ON duty due to thermal effects.

## Electronic protection devices EPD24

### Technical information

#### Time/Current characteristic curve ( $T_{\text{ambient}} = 25\text{ °C}$ )

The trip time is typically 3 s in the range between  $1.1$  and  $1.8 \times I_N^{1)}$ .

Electronic current limitation occurs at typically  $1.8 \times I_N^{1)}$  which means that under all overload conditions (independent of the power supply and the resistance of the load circuit) the max. overload before disconnection will not exceed  $1.8 \times I_N^{1)}$  times the current rating. Trip time is between 100 ms and 3 sec (depending on overload or at short circuit).

Without this current limitation a considerably higher overload current would flow in the event of an overload or short circuit.

#### Maximum cable lengths

EPD24 reliably trips from  $0\ \Omega$  up to max. circuit resistance  $R_{\text{max}}$ .

#### Calculation of $R_{\text{max}}$

Selected rating $I_N$ (A)	3	6
Operating voltage $U_g$ (V DC) (= 80 % of 24 V) <sup>2)</sup>	19.2	19.2
Trip current $I_{\text{ab}} = 1.25 \times I_N$ (A) (EPD24 trips after 3 s)	3.75	7.50
$R_{\text{max}} (\Omega) = (U_g / I_{\text{ab}}) - 0.050$	5.07	2.51

<sup>2)</sup> Voltage drop of EPD24 and tolerance of trip point (typically  $1.1 \times I_N = 1.05 \dots 1.35 \times I_N$ ) have been taken into account

#### Selection table for the incoming cable lengths with different cable cross-sections

Cable cross section A (mm <sup>2</sup> )	0.14	0.25	0.34	0.5	0.75	1.00	1.50
Cable length L (m) (= single length)	cable resistance ( $\Omega$ ) = $(\rho_0 \times 2 \times L) / A^{3)}$						
5	1.27	0.71	0.52	0.36	0.24	0.18	0.12
10	2.54	1.42	1.05	0.71	0.47	0.36	0.24
15	3.81	2.14	1.57	1.07	0.71	0.53	0.36
20	5.09	2.85	2.09	1.42	0.95	0.71	0.47
25	6.36	3.56	2.62	1.78	1.19	0.89	0.59
30	7.63	4.27	3.14	2.14	1.42	1.07	0.71
35	8.90	4.98	3.66	2.49	1.66	1.25	0.83
40	10.17	5.70	4.19	2.85	1.90	1.42	0.95
45	11.44	6.41	4.71	3.20	2.14	1.60	1.07
50	12.71	7.12	5.24	3.56	2.37	1.78	1.19
75	19.07	10.68	7.85	5.34	3.56	2.67	1.78
100	25.34	14.24	10.47	7.12	4.75	3.56	2.37
125	31.79	17.80	13.09	8.90	5.93	4.45	2.97
150	38.14	21.36	15.71	10.68	7.12	5.34	3.56
175	44.50	24.92	18.32	12.46	8.31	6.23	4.15
200	50.86	28.48	20.94	14.24	9.49	7.12	4.75
225	57.21	32.04	23.56	16.02	10.68	8.01	5.34
250	63.57	35.60	26.18	17.80	11.87	8.90	5.93

<sup>3)</sup> Resistivity of copper  $\rho_0 = 0.0178 (\Omega \times \text{mm}^2) / \text{m}$

Example 1: max. length for 1.5 mm<sup>2</sup> and 3 A: 214 m

Example 2: max. length for 1.5 mm<sup>2</sup> and 6 A: 106 m

Example 3: mixed wiring: (Control cabinet --- sensor/actuator level)

R1 = 40 m for 1.5 mm<sup>2</sup> and R2 = 5 m for 0.25 mm<sup>2</sup>:

R1 = 0.95  $\Omega$ , R2 = 0.71  $\Omega$ , total (R1 + R2) = 1.66  $\Omega$

# Electronic protection devices EPD24

## Technical diagrams

### Time/current characteristic curve

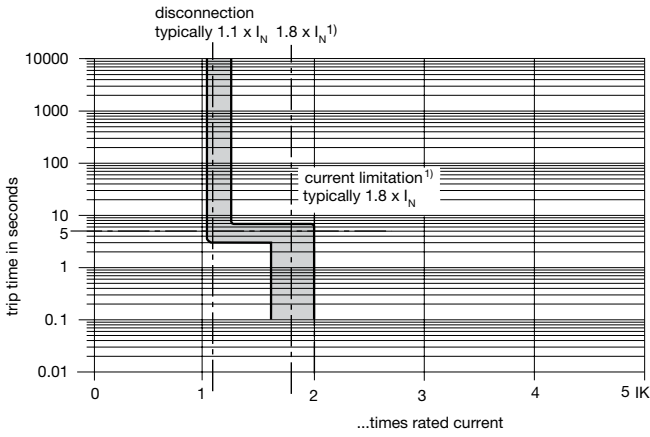

<sup>1)</sup> Current limitation typically  $1.8 \times I_N$  at  $I_N = 0.5 \text{ A} \dots 6 \text{ A}$   
 Current limitation typically  $1.5 \times I_N$  at  $I_N = 8 \text{ A}$  or  $10 \text{ A}$   
 Current limitation typically  $1.3 \times I_N$  at  $I_N = 12 \text{ A}$

### Wiring diagram

EPD24-TB-101  
 without signal input  
 with signal output F  
 (Single signal, N/O)

Operating condition: 13-14 closed  
 Fault condition: 13-14 open

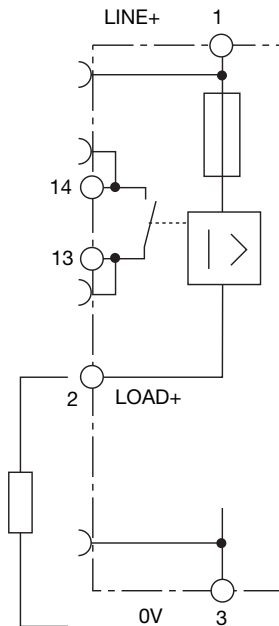

## Electronic protection devices EPD24

### Approvals, Safety instructions

#### Please note

The user must ensure that the cable cross sections of the relevant load circuit are suitable for the current rating of the EPD24 used. Automatic start-up of machinery after shut down must be prevented (Machinery Directive 2006/42/EU and IEC/EN 60204-1). In the event of a short circuit or overload the load circuit will be disconnected electronically by the EPD24.

#### Information on UL approvals/CSA approvals



UL1604  
UL File # E 339238



CSA C22.2 No. 213 (Class I, Division 2)  
CSA File # 2305929

#### Operating Temperature Code T5

- This equipment is suitable for use in Class I, Division 2, Groups A, B, C and D or non-hazardous locations only

#### WARNING:

- Exposure to some chemicals may degrade the sealing properties of materials used in the following device: relay  
Sealant Material:
  - Generic Name: Modified diglycidyl ether of bisphenol A
  - Supplier: Fine Polymers Corporation
  - Type: Epi Fine 4616L-160PK
- Casing Material:
  - Generic Name: Liquid Crystal Polymer
  - Supplier: Sumitomo Chemical
  - Type: E4008, E4009, or E6008

#### RECOMMENDATION:

- Periodically inspect the device named above for any degradation of properties and replace if degradation is found

#### WARNING – EXPLOSION HAZARD:

- Do not disconnect equipment unless power has been removed or the area is known to be non-hazardous
- Substitution of any components may impair suitability for Class I, Division 2



UL2367  
Non-hazardous use - UL File # E 339236



UL 508  
Non-hazardous use - UL File # E 149922



CSA C22.2 No. 14  
CSA C22.2 No. 142 - CSA File # E 2305929

Class 2

Meets requirement for Class 2 current limitation (EPD24 ... -0.5 A/1 A/2 A/3 A)

# Electronic protection devices EPD24

## Installation guidelines

The EPD24 features an integral power distribution system.

The following wiring modes are possible with various pluggable current and signal busbars:

- LINE+ (24 V DC)
- 0 V
- Caution: The electronic devices EPD24 require a 0 V connection
- Auxiliary contacts

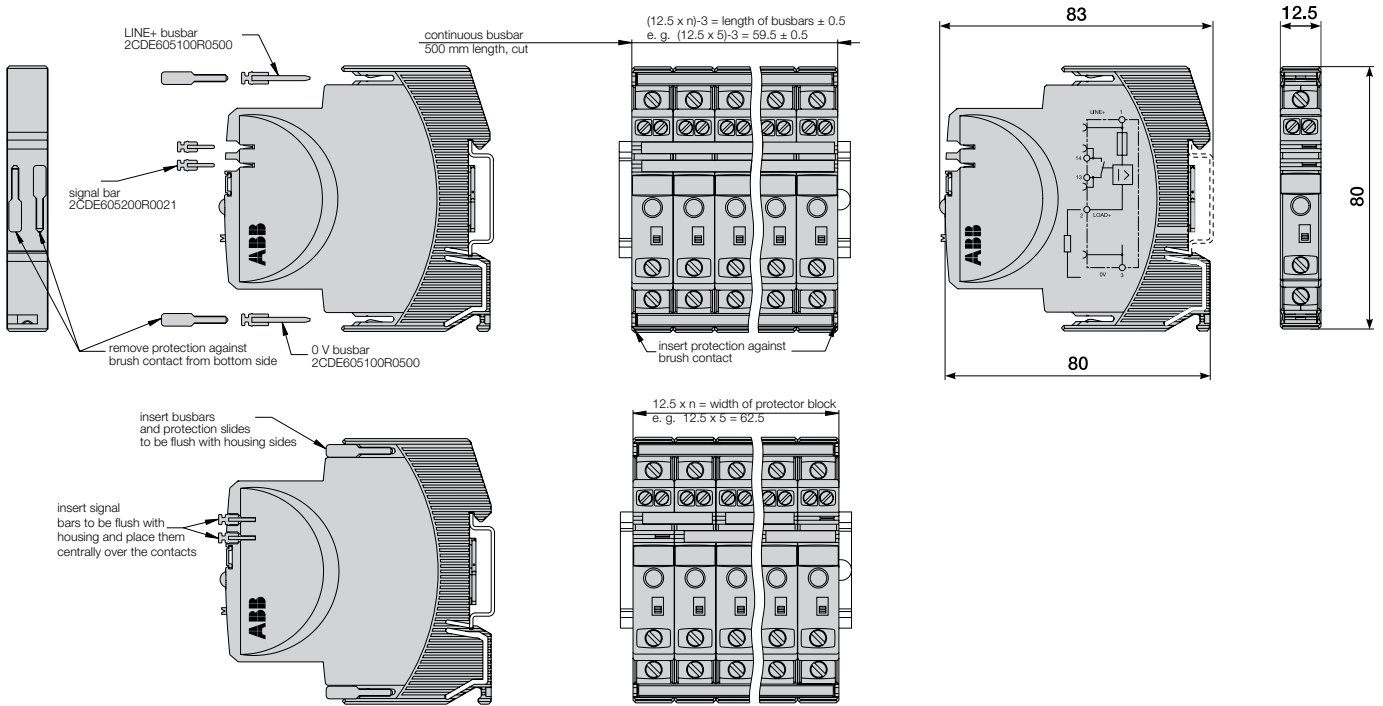

### Mounting procedure

Before wiring insert busbars into protector block. A maximum of 10 connection cycles are permissible using connecting busbars.

### Recommendation

After 10 units the busbars should be interrupted and receive a new entry live.

### Table of length for busbars

(Order code 2CDE605100R0500)

No. of units	2	3	4	5	6	7	8	9	10
Length of busbar (mm) ± 0.5 mm	22	34.5	47	59.5	72	84.5	97	109.5	122





# Index

## Product type

Type	Order code	Page
CP-B 24/10.0	1SVR427060R1000	105
CP-B 24/20.0	1SVR427060R2000	105
CP-B 24/3.0	1SVR427060R0300	105
CP-C.1 24/10.0	1SVR360663R1001	70
CP-C.1 24/10.0-C	1SVR360663R2001	70
CP-C.1 24/10.0-L	1SVR361663R1001	70
CP-C.1 24/20.0	1SVR360763R1001	70
CP-C.1 24/20.0-C	1SVR360763R2001	70
CP-C.1 24/20.0-L	1SVR361763R1001	70
CP-C.1 24/5.0	1SVR360563R1001	70
CP-C.1 24/5.0-C	1SVR360563R2001	70
CP-C.1 24/5.0-L	1SVR361563R1001	70
CP-C.1-A-RU	1SVR360060R1001	118
CP-C.1-A-RU-C	1SVR360060R2001	118
CP-C.1-A-RU-L	1SVR361060R1001	118
CP-D 12/0.83	1SVR427041R1000	94
CP-D 12/2.1	1SVR427043R1200	94
CP-D 24/0.42	1SVR427041R0000	94
CP-D 24/1.3	1SVR427043R0100	94
CP-D 24/2.5	1SVR427044R0200	94
CP-D 24/4.2	1SVR427045R0400	94
CP-D RU	1SVR427049R0000	118
CP-E 12/10.0	1SVR427035R1000	18
CP-E 12/2.5	1SVR427032R1000	18
CP-E 24/0.75	1SVR427030R0000	18
CP-E 24/1.25	1SVR427031R0000	18
CP-E 24/10.0	1SVR427035R0000	18
CP-E 24/2.5	1SVR427032R0000	18
CP-E 24/20.0	1SVR427036R0000	18
CP-E 24/5.0	1SVR427034R0000	18
CP-E 48/0.62	1SVR427030R2000	18
CP-E 48/1.25	1SVR427031R2000	18
CP-E 48/10.0	1SVR427035R2000	18
CP-E 48/5.0	1SVR427034R2000	18
CP-E 5/3.0	1SVR427033R3000	18
CP-S.1 24/3.0	1SVR320361R1000	56
CP-S.1 24/5.0	1SVR320561R1000	56
CP-S.1 24/10.0	1SVR320661R1000	56
CP-S.1 24/20.0	1SVR320761R1000	56
CP-S.1 24/40.0	1SVR320861R1000	56
CP-C.1-A-RU	1SVR360060R1001	56
CP-T 24/10.0	1SVR427055R0000	38
CP-T 24/20.0	1SVR427056R0000	38
CP-T 24/40.0	1SVR427057R0000	38
CP-T 24/5.0	1SVR427054R0000	38
CP-T 48/10.0	1SVR427055R2000	38
CP-T 48/20.0	1SVR427056R2000	38
CP-T 48/5.0	1SVR427054R2000	38
EPD24-TB-101-0.5A	2CDE601101R2905	128
EPD24-TB-101-10A	2CDE601101R2010	128
EPD24-TB-101-12A	2CDE601101R2012	128

Type	Order code	Page
EPD24-TB-101-1A	2CDE601101R2001	128
EPD24-TB-101-2A	2CDE601101R2002	128
EPD24-TB-101-3A	2CDE601101R2003	128
EPD24-TB-101-4A	2CDE601101R2004	128
EPD24-TB-101-6A	2CDE601101R2006	128
EPD24-TB-101-8A	2CDE601101R2008	128
EPD-BB500	2CDE605100R0500	128
EPD-SB21	2CDE605200R0021	128

# Index

## Order code

Order code	Type	Page
1SVR360060R1001	CP-C.1-A-RU	118
1SVR360060R2001	CP-C.1-A-RU-C	118
1SVR360563R1001	CP-C.1 24/5.0	70
1SVR360563R2001	CP-C.1 24/5.0-C	70
1SVR360663R1001	CP-C.1 24/10.0	70
1SVR360663R2001	CP-C.1 24/10.0-C	70
1SVR360763R1001	CP-C.1 24/20.0	70
1SVR360763R2001	CP-C.1 24/20.0-C	70
1SVR361060R1001	CP-C.1-A-RU-L	118
1SVR361563R1001	CP-C.1 24/5.0-L	70
1SVR361663R1001	CP-C.1 24/10.0-L	70
1SVR361763R1001	CP-C.1 24/20.0-L	70
1SVR320361R1000	CP-S.1 24/3.0	56
1SVR320561R1000	CP-S.1 24/5.0	56
1SVR320661R1000	CP-S.1 24/10.0	56
1SVR320761R1000	CP-S.1 24/20.0	56
1SVR320861R1000	CP-S.1 24/40.0	56
1SVR360060R1001	CP-C.1-A-RU	118
1SVR427030R0000	CP-E 24/0.75	18
1SVR427030R2000	CP-E 48/0.62	18
1SVR427031R0000	CP-E 24/1.25	18
1SVR427031R2000	CP-E 48/1.25	18
1SVR427032R0000	CP-E 24/2.5	18
1SVR427032R1000	CP-E 12/2.5	18
1SVR427033R3000	CP-E 5/3.0	18
1SVR427034R0000	CP-E 24/5.0	18
1SVR427034R2000	CP-E 48/5.0	18
1SVR427035R0000	CP-E 24/10.0	18
1SVR427035R1000	CP-E 12/10.0	18
1SVR427035R2000	CP-E 48/10.0	18
1SVR427036R0000	CP-E 24/20.0	18
1SVR427041R0000	CP-D 24/0.42	94
1SVR427041R1000	CP-D 12/0.83	94
1SVR427043R0100	CP-D 24/1.3	94
1SVR427043R1200	CP-D 12/2.1	94
1SVR427044R0200	CP-D 24/2.5	94
1SVR427045R0400	CP-D 24/4.2	94
1SVR427049R0000	CP-D RU	118
1SVR427054R0000	CP-T 24/5.0	38
1SVR427054R2000	CP-T 48/5.0	38
1SVR427055R0000	CP-T 24/10.0	38
1SVR427055R2000	CP-T 48/10.0	38
1SVR427056R0000	CP-T 24/20.0	38
1SVR427056R2000	CP-T 48/20.0	38
1SVR427057R0000	CP-T 24/40.0	38
1SVR427060R0300	CP-B 24/3.0	108
1SVR427060R1000	CP-B 24/10.0	108
1SVR427060R2000	CP-B 24/20.0	108
2CDE601101R2001	EPD24-TB-101-1A	128
2CDE601101R2002	EPD24-TB-101-2A	128
2CDE601101R2003	EPD24-TB-101-3A	128

Order code	Type	Page
2CDE601101R2004	EPD24-TB-101-4A	128
2CDE601101R2006	EPD24-TB-101-6A	128
2CDE601101R2008	EPD24-TB-101-8A	128
2CDE601101R2010	EPD24-TB-101-10A	128
2CDE601101R2012	EPD24-TB-101-12A	128
2CDE601101R2905	EPD24-TB-101-0.5A	128
2CDE605100R0500	EPD-BB500	128
2CDE605200R0021	EPD-SB21	128

---

**ABB STOTZ-KONTAKT GmbH**

Eppelheimer Strasse 82  
69123 Heidelberg  
Germany

**You can find the address of your local  
sales organization on the ABB homepage**



**[abb.com/lowvoltage](http://abb.com/lowvoltage)**

---

We reserve the right to make technical changes or modify the contents of this document without prior notice. With regard to purchase orders, the agreed particulars shall prevail. ABB Ltd. does not accept any responsibility whatsoever for potential errors or possible lack of information in this document.

We reserve all rights in this document and in the subject matter and illustrations contained therein. Any reproduction, disclosure to third parties or utilization of its contents – in whole or in parts – is forbidden without prior written consent of ABB Ltd. Copyright© 2022 ABB Ltd.  
All rights reserved