

1YM M.2 Module (EAR00370) Datasheet

- Wi-Fi 5, 802.11 a/b/g/n/ac 2x2 MU-MIMO
- Bluetooth 5.2 BR/EDR/LE
- PCIe interface, in M.2 form factor (22 x 30 mm)
- Chipset: NXP 88W8997

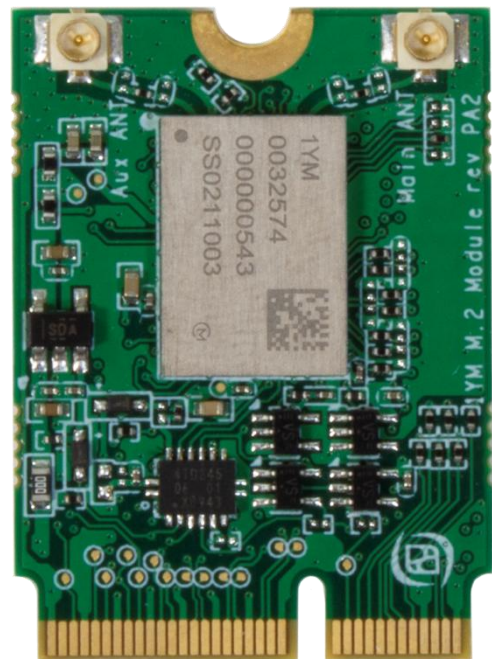

*Get Up-and-Running Quickly and
Start Developing Your Application On Day 1!*

Embedded Artists AB

Rundelsgatan 14
211 36 Malmö
Sweden

<https://www.EmbeddedArtists.com>

Copyright 2021 © Embedded Artists AB. All rights reserved.

No part of this publication may be reproduced, transmitted, transcribed, stored in a retrieval system, or translated into any language or computer language, in any form or by any means, electronic, mechanical, magnetic, optical, chemical, manual or otherwise, without the prior written permission of Embedded Artists AB.

Disclaimer

Embedded Artists AB makes no representation or warranties with respect to the contents hereof and specifically disclaim any implied warranties or merchantability or fitness for any particular purpose. The information has been carefully checked and is believed to be accurate, however, no responsibility is assumed for inaccuracies.

Information in this publication is subject to change without notice and does not represent a commitment on the part of Embedded Artists AB.

Feedback

We appreciate any feedback you may have for improvements on this document.

Trademarks

All brand and product names mentioned herein are trademarks, services marks, registered trademarks, or registered service marks of their respective owners and should be treated as such.

Table of Contents

1	Document Information	4
1.1	Revision History	4
2	Introduction	5
2.1	Benefits of Using an M.2 Module to get Wi-Fi/BT Connectivity	5
2.2	More M.2 Related Information	5
2.3	ESD Precaution and Handling	6
2.4	Product Compliance	6
3	Specification	7
3.1	Power Up Sequence	8
3.2	External Sleep Clock	8
3.3	Mechanical Dimensions	8
3.4	M.2 Pinning	10
3.5	VDDIO Override Feature	13
3.6	SDIO Interface	13
3.7	Test Points	14
3.8	Set SDIO Host Interface	15
3.8.1	SDIO Clock Frequency Limit	15
3.9	Current Consumption Measurements	16
4	Antenna	17
4.1	Antenna Connector	17
5	Software and Support	18
5.1	Software Driver	18
5.2	Support	18
6	Regulatory	19
6.1	European Union Regulatory Compliance	19
7	Disclaimers	20
7.1	Definition of Document Status	21

1 Document Information

This document applies to the following products.

<i>Product Name</i>	<i>Type Number</i>	<i>Murata Module</i>	<i>Chipset</i>	<i>Product Status</i>
1YM M.2 Module, rev A	EAR00370	LBEE5XV1YM-574	88W8997	Initial Production

1.1 Revision History

<i>Revision</i>	<i>Date</i>	<i>Description</i>
PA1	2020-08-28	First version.
PA2	2021-10-05	Updated document format.

2 Introduction

This document is a datasheet that specifies and describes the *1YM M.2 module* mainly from a hardware point of view.

The main component in the design is Murata's 1YM module (full part number: LBEE5XV1YM-574), which in turn is based on the NXP 88W8997 chipset. The 1YM module enable Wi-Fi, Bluetooth and Bluetooth Low Energy (LE) communication.

There are multiple application areas for the 1YM M.2 Module:

- Industrial and building automation
- Asset management
- IoT applications
- Smart home: Voice assist device, smart printer, smart speaker, home automation gateway, and IP camera
- Retail/POS
- Healthcare and medical devices
- Smart city

2.1 Benefits of Using an M.2 Module to get Wi-Fi/BT Connectivity

There are several benefits to use an *M.2 module* to add connectivity to an embedded design:

- Drop-in, certified solution!
- Modular and flexible approach to evaluate different Wi-Fi/BT solutions - with different trade-offs around performance, cost, power consumption, longevity, etc.
- Access to maintained software drivers (Linux) with responsive support from Murata.
- Supported by Embedded Artists' Developer's Kits for i.MX RT/6/7/8 development, including advanced debugging support on carrier boards
- One component to buy, instead of 30+
- No RF expertise is required
- Developed in close collaboration with Murata and NXP

2.2 More M.2 Related Information

For more information about the M.2 standard and Embedded Artists' adaptation, see: [M.2 Primer](#)

For more general information about the M.2 standard, see: <https://en.wikipedia.org/wiki/M.2>

The official M.2 specification (PCI Express M.2 Specification) is available from: www.pcisig.com

2.3 ESD Precaution and Handling

Please note that the M.2 module come without any case/box and all components are exposed for finger touches – and therefore extra attention must be paid to ESD (electrostatic discharge) precaution, for example use of static-free workstation and grounding strap. Only qualified personnel shall handle the product.



Make it a habit always to first touch the mounting hole (which is grounded) for a few seconds with both hands before touching any other parts of the boards. That way, you will have the same potential as the board and therefore minimize the risk for ESD.

In general touch as little as possible on the boards in order to minimize the risk of ESD damage. The only reasons to touch the board are when mounting/unmounting it on a carrier board.

Note that Embedded Artists does not replace modules that have been damaged by ESD.

2.4 Product Compliance

Visit Embedded Artists' website at http://www.embeddedartists.com/product_compliance for up to date information about product compliances such as CE, RoHS2, Conflict Minerals, REACH, etc.

3 Specification

This chapter lists some of the more important characteristics of the M.2 module, but it is not a full specification of performance and timing. The main component in the design is Murata's 1YM module (full part number: LBEE5XV1YM), which in turn is based around NXP's 88W8997 chipset.

For a full specification, see Murata's 1YM Module (LBEE5XV1YM-574) product page: <https://www.murata.com/products/connectivitymodule/wi-fi-bluetooth/overview/lineup/type1ym> and the 1YM datasheet: <https://wireless.murata.com/datasheet?/RFM/data/type1ym.pdf>

Module / Chipset	
Murata module	LBEE5XV1YM-574
Chipset	NXP 88W8997

Wi-Fi	
Standards	802.11 a/b/g/n/ac 2x2 MU-MIMO, Wi-Fi 5
Network	uAP and STA dual mode
Frequency	2.4GHz and 5 GHz band
Data rates	11, 54, 192.6, 400, 866 Mbps
Host interface	PCIe up to 5 GT/s (default) or SDIO 3.0, SDR104@208MHz / DDR50@50MHz with rework (or on special order)

Bluetooth	
Standards	5.2 BR/EDR/LE, 3Mbps PHY
Power Class	Class 1
Host interface	4-wire UART@4MBaud
Audio interface	PCM for audio

Powering			
Supply voltage to M.2 module	Min	Typ	Max
	0.0V minimum 3.0V operating and RF specification	3.3V	3.6V
Note: Do not exceed minimum or maximum voltage. Module will be permanently damaged above this limit!			Note that LBEE5XV1YM module specification has higher maximum voltage (5.5V), but other components on the M.2 module limit the maximum voltage.
Peak current	1.3A max		The power supply must be designed for this peak current, which typically happen during the startup calibration process.
Receive mode current (WLAN)	220 mA typical max		Note that current consumption varies widely between different operational modes.

Transmit mode current (WLAN)	540 mA typical max
------------------------------	--------------------

Environmental Specification

Operational Temperature	-30 to +85 degrees Celsius	Functionally ok, but specification is derated at temperature extremes
Storage Temperature	-30 to +85 degrees Celsius	
Relative Humidity (RH), operating and storage	10 - 90% non-condensing	

3.1 Power Up Sequence

The 3.3V supply voltage shall not rise (10 - 90%) faster than 40 microseconds and not slower than 100 milliseconds.

M.2 signal W_DISABLE1# (chipset signal PMIC_EN) must be held low for at least 100 milliseconds after supply voltage has reached specification level before pulled high.

3.2 External Sleep Clock

The sleep clock signals can be applied to a powered and unpowered M.2 module.

Clock Specification	
Frequency	32.768 kHz
Frequency accuracy	±250 ppm (including tolerance, aging, temperature, etc)
Duty cycle	20 - 80%
Clock jitter	1.5ns RMS typical
Voltage level	3.3V logic, according to M.2 standard

3.3 Mechanical Dimensions

The M.2 module is of type: 2230-S3-E according to the M.2 nomenclature. This means width 22 mm, length 30mm, top side component height 1.5 mm and key-E connector. The table below lists the different dimensions and weight.

M.2 Module Dimension	Value (±0.15 mm)	Unit
Width	22	mm
Height	30	mm
PCB thickness	0.8	mm
Maximum component height on top side	1.5	mm
Maximum component height on bottom side	0	mm
Ground hole diameter	3.5	mm
Plating around ground hole, diameter	5.5	mm
Module weight	1.5 ±0.5 gram	gram

The picture below gives dimensions for the grounded center (half) hole and the u.fl. antenna connectors.

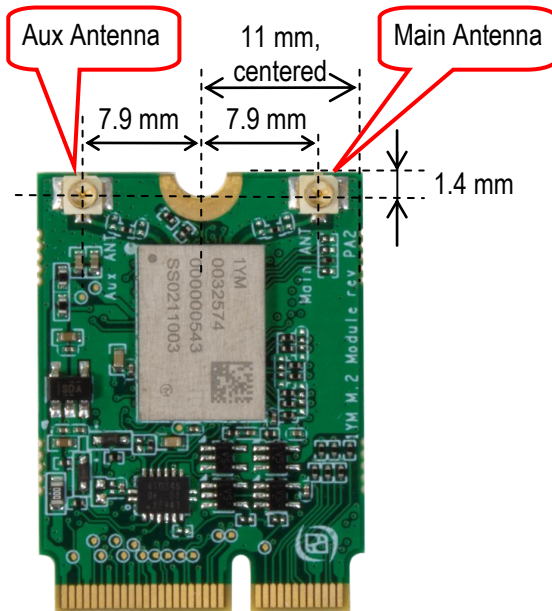

Figure 1 – M.2 Module Antenna Connector Measurements

3.4 M.2 Pinning

This section presents the pinning used for the M.2 module. It is essentially M.2 Key-E compliant with enhancements to support additional debug signals and 3.3V VDDIO override. The pin assignment for specific control and debug signals has been jointly defined by Embedded Artists, Murata, NXP and Infineon (former Cypress).

The picture below illustrates the edge pin numbering. It starts on the right edge and alternates between top and bottom side. The removed pads in the keying notch count (but are obviously non-existing).

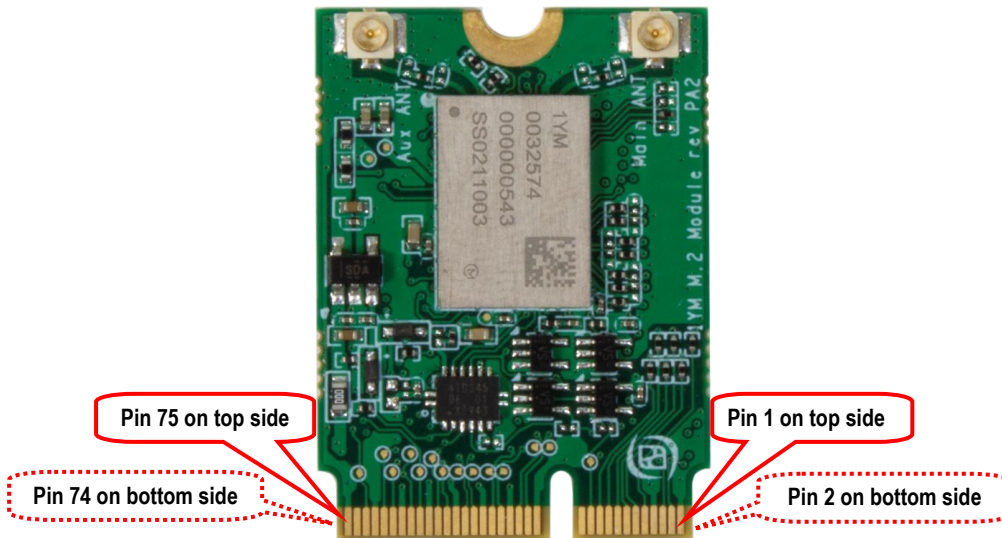

Figure 2 – M.2 Module Pin Numbering

The Wi-Fi interface uses the PCIe interface as default but it is possible to configure the module to use the SDIO interface instead, see section 3.8 for details. The Bluetooth interface uses the UART interface for control and PCM interface for audio. The table below lists the pin usage for the 1YM M.2 modules. The column "When is signal needed" signals four different categories:

- Always: These signals shall always be connected.
- Wi-Fi PCIe: These signals shall always be connected then the PCIe interface is used for Wi-Fi
- Wi-Fi SDIO: These signals shall always be connected then the SDIO interface is used for Wi-Fi
- Bluetooth: These signals shall always be connected then the Bluetooth interface is used.
- Optional: These signals are optional to connect.

Pin #	Side of pcb	M.2 Name	Voltage Level and Signal Direction	When is signal needed	Note
1	Top	GND	GND	Always	Connect to ground
2	Bottom	3.3 V		Always	Power supply input. Connect to stable, low-noise 3.3V supply.
3	Top	USB_D+			Not connected.
4	Bottom	3.3 V		Always	Power supply input. Connect to stable, low-noise 3.3V supply.
5	Top	USB_D-			Not connected.
6	Bottom	LED_1#	1.8V OD output from		GPIO_2

M.2 ⁽¹⁾					
7	Top	GND	GND	Always	Connect to ground.
8	Bottom	PCM_CLK	1.8V I/O ⁽¹⁾	Bluetooth audio	For Bluetooth audio interface: BT_PCM_CLK
9	Top	SDIO_CLK		Wi-Fi SDIO	For Wi-Fi SDIO interface: SDIO_CLK Note that maximum frequency is 200 MHz and this interface is not enabled by default
10	Bottom	PCM_SYNC	1.8V I/O ⁽¹⁾	Bluetooth audio	For Bluetooth audio interface: BT_PCM_SYNC
11	Top	SDIO_CMD		Wi-Fi SDIO	For Wi-Fi SDIO interface: SDIO_CMD Note: 10-100K ohm pullup required and this interface is not enabled by default
12	Bottom	PCM_OUT	1.8V output from M.2 ⁽¹⁾	Bluetooth audio	For Bluetooth audio interface: BT_PCM_OUT
13	Top	SDIO DATA0		Wi-Fi SDIO	For Wi-Fi SDIO interface: SDIO_D0 Note: 10-100K ohm pullup required and this interface is not enabled by default
14	Bottom	PCM_IN	1.8V input to M.2 ⁽¹⁾	Bluetooth audio	For Bluetooth audio interface: BT_PCM_IN
15	Top	SDIO DATA1		Wi-Fi SDIO	For Wi-Fi SDIO interface: SDIO_D1 Note: 10-100K ohm pullup required and this interface is not enabled by default
16	Bottom	LED_2#	1.8V OD output from M.2 ⁽¹⁾		GPIO_3
17	Top	SDIO DATA2		Wi-Fi SDIO	For Wi-Fi SDIO interface: SDIO_D2 Note: 10-100K ohm pullup required and this interface is not enabled by default
18	Bottom	GND		Always	Connect to ground.
19	Top	SDIO DATA3		Wi-Fi SDIO	For Wi-Fi SDIO interface: SDIO_D3 Note: 10-100K ohm pullup required and this interface is not enabled by default
20	Bottom	UART WAKE#	3.3V OD output from M.2	Bluetooth	For Bluetooth UART interface: BT_HOST_WAKE_L Require an external 10K pull-up resistor to 3.3V.
21	Top	SDIO WAKE#		Wi-Fi SDIO	For Wi-Fi SDIO interface: WL_HOST_WAKE_L Note: require an external 10K pullup resistor to 1.8V and this interface is not enabled by default
22	Bottom	UART TXD	1.8V output from M.2 ⁽¹⁾	Bluetooth	For Bluetooth UART interface: BT_UART_TXD
23	Top	SDIO RESET#			Not connected. The Wi-Fi interface is controlled by pin 56, W_DISABLE1#, which is a 3.3V logic level signal.
24	Key, non existing				
25	Key, non existing				
26	Key, non existing				
27	Key, non existing				
28	Key, non existing				
29	Key, non existing				
30	Key, non existing				
31	Key, non existing				
32	Bottom	UART_RXD	1.8V input to M.2 ⁽¹⁾	Bluetooth	For Bluetooth UART interface: BT_UART_RXD
33	Top	GND		Always	Connect to ground.
34	Bottom	UART_RTS	1.8V output from M.2 ⁽¹⁾	Bluetooth	For Bluetooth UART interface: BT_UART_RTS

35	Top	PERp0	PCIe input to M.2	Wi-Fi PCIe	PCIe data input (receive, positive signal)
36	Bottom	UART_CTS	1.8V input to M.2 ^[1]	Bluetooth	For Bluetooth UART interface: BT_UART_CTS
37	Top	PERn0	PCIe input to M.2	Wi-Fi PCIe	PCIe data input (receive, negative signal)
38	Bottom	VENDOR DEFINED	1.8V I/O ^[1]	Optional	GPIO_17 / JTAG_TDO / COEX_TXD
39	Top	GND		Always	Connect to ground.
40	Bottom	VENDOR DEFINED	1.8V I/O ^[1]	Wi-Fi SDIO (optional)	GPIO_18 / WL_DEV_WAKE_L Note: this signal is also routed to pin 66 and this signal is not enabled by default
41	Top	PETp0	PCIe output to M.2	Wi-Fi PCIe	PCIe data output (transmit, positive signal)
42	Bottom	VENDOR DEFINED	1.8V input to M.2 ^[1]	Bluetooth	GPIO_12 / BT_DEV_WAKE_L
43	Top	PETn0	PCIe output to M.2	Wi-Fi PCIe	PCIe data output (transmit, negative signal)
44	Bottom	COEX3	1.8V I/O ^[1]	Optional	GPIO_16 / JTAG_TDI / COEX_RXD
45	Top	GND		Always	Connect to ground.
46	Bottom	COEX_TXD	1.8V I/O ^[1]	Optional	GPIO_14 / JTAG_TCK
47	Top	REFCLKp0	PCIe clock input to M.2	Wi-Fi PCIe	PCIe clock input (receive, positive signal)
48	Bottom	COEX_RXD	1.8V I/O ^[1]	Optional	GPIO_15 / JTAG_TMS
49	Top	REFCLKn0	PCIe clock input to M.2	Wi-Fi PCIe	PCIe clock input (receive, negative signal)
50	Bottom	SUSCLK	3.3V input to M.2	Always	External sleep clock input (32.768kHz)
51	Top	GND		Always	Connect to ground.
52	Bottom	PERST0#	3.3V input to M.2	Wi-Fi PCIe	PCIe PERST# signal, used to initialize the M.2 functions once power sources stabilize.
53	Top	CLKREQ0#	3.3V OD output from M.2	Wi-Fi PCIe	PCIe clock request (low level request reference clock) Note: Requires external 10Kohm pull-up
54	Bottom	W_DISABLE2#			Not connected
55	Top	PEWAKE0#	3.3V OD output from M.2	Wi-Fi PCIe	PCIe PERST# signal, used to implement host wakeup functionality Note: Requires external 10Kohm pull-up
56	Bottom	W_DISABLE1#	3.3V input to M.2	Always	PMIC_EN, High = Module enabled/internally powered, Low = Module disabled/powered down Note: Signal has on-board 100Kohm pull-up resistor
57	Top	GND		Always	Connect to ground.
58	Bottom	I2C_SDA			Connected to 1YM pin 34
59	Top	Reserved	1.8V I/O ^[1]	Optional	GPIO_24
60	Bottom	I2C_CLK			Connected to 1YM pin 35
61	Top	Reserved	1.8V I/O ^[1]	Optional	GPIO_25
62	Bottom	ALERT#	1.8V I/O ^[1]	Optional	GPIO_23
63	Top	GND		Always	Connect to ground.
64	Bottom	RESERVED		Optional	Optional supply voltage input for control and data signal voltage level. Apply a stable, low-noise, 3.3V 100mA supply to set 3.3V voltage level on all control signals (that normally are 1.8V).
65	Top	Reserved	1.8V I/O ^[1]	Optional	GPIO_26
66	Bottom	UIM_SWP		Wi-Fi SDIO	GPIO_18 / WL_DEV_WAKE_L Note: this signal is also routed to pin 40 and this interface is not enabled by default

67	Top	Reserved	1.8V I/O ^[1]	Optional	GPIO_27
68	Bottom	UIM_POWER_SNK	1.8V I/O ^[1]	Optional	GPIO_1
69	Top	GND		Always	Connect to ground.
70	Bottom	UIM_POWER_SRC/GPIO_1	1.8V I/O ^[1]	Optional	GPIO_0
71	Top	Reserved	1.8V I/O ^[1]	Optional	GPIO_20
72	Bottom	3.3 V		Always	Power supply input. Connect to stable, low-noise 3.3V supply.
73	Top	Reserved			Not connected.
74	Bottom	3.3 V		Always	Power supply input. Connect to stable, low-noise 3.3V supply.
75	Top	GND		Always	Connect to ground.

^[1]Note: If applying 3.3V to pin 64, the signaling voltage is changed to 3.3V

3.5 VDDIO Override Feature

The M.2 standard specify 1.8V logic level on several of the data and control signals. It is possible to override the voltage level for the 1.8V signals via pin 64. Apply a 3.3V / 100 mA supply to pin 64 in order to get 3.3V voltage level on all data and control signals.

Note: Changing VDDIO does not make sense when the Wi-Fi PCIe interface is used since the voltage levels of the PCIe interface are fixed and the PCIe related control signals are already defined for 3.3V operation (by the M.2 specification). The Bluetooth interface signals will however change from 1.8V to 3.3V logic levels.

Note: If SDIO is used for the Wi-Fi interface, the SDIO control signals will have 3.3V signaling level. Also note that this limits the SDIO clock to 50 MHz, thereby limiting throughput. Running at 1.8V VIO will support up to 200 MHz SDIO clock (on rev A boards) which is ultimately needed for maximum 802.11ac throughput.

3.6 SDIO Interface

The SDIO interface conforms to the SDIO v3.0 specification, including the UHS-I modes, and is backward compatible with SDIO v2.0.

SDIO bus speed modes	Max SDIO clock frequency	Max bus speed	Signaling voltage according to M.2 specification	Supported in 3.3V VDDIO Override Mode
DS (Default speed)	25 MHz	12.5 MByte/s	1.8 V	Yes
HS (High speed)	50 MHz	25 MByte/s	1.8 V	Yes
SDR12	25 MHz	12.5 MByte/s	1.8 V	No
SDR25	50 MHz	25 MByte/s	1.8 V	No
SDR50	100 MHz	50 MByte/s	1.8 V	No
SDR104	208 MHz	104 MByte/s	1.8 V	No
DDR50	50 MHz	50 MByte/s	1.8 V	No

3.7 Test Points

There are some test points that can be of interest to probe for debugging purposes, as illustrated in the pictures below (note the different in board revisions).

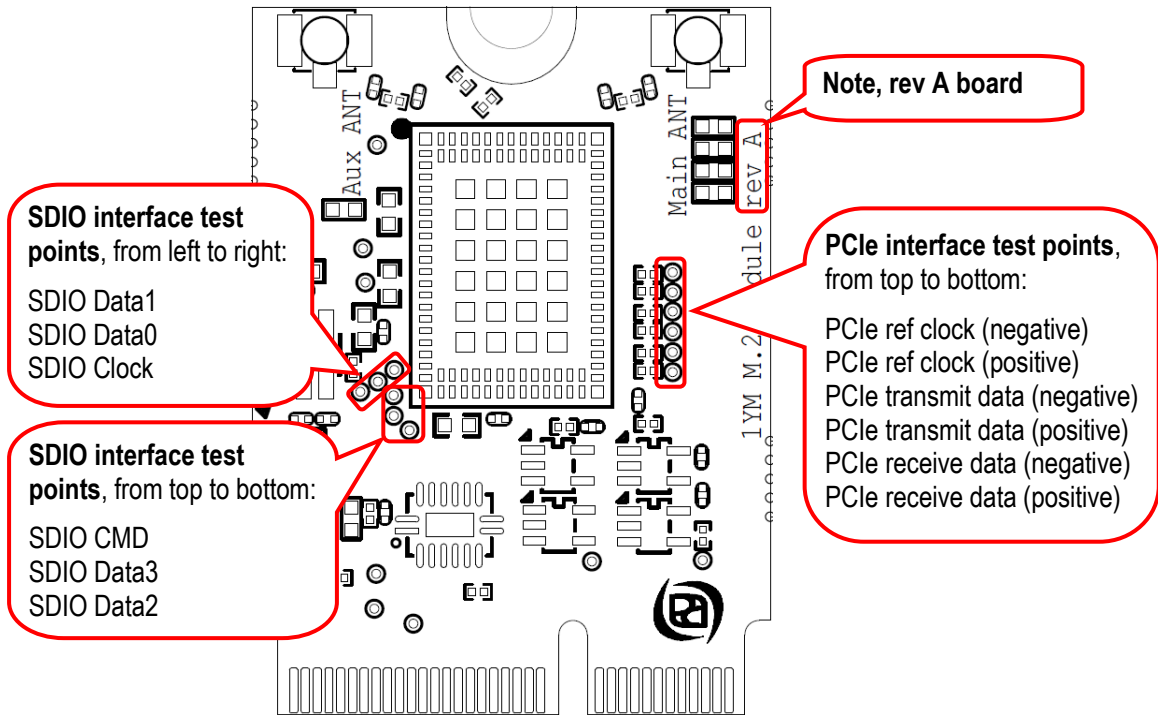

Figure 3 – 1YM M.2 Module PCIe and SDIO Test Points on rev A Boards

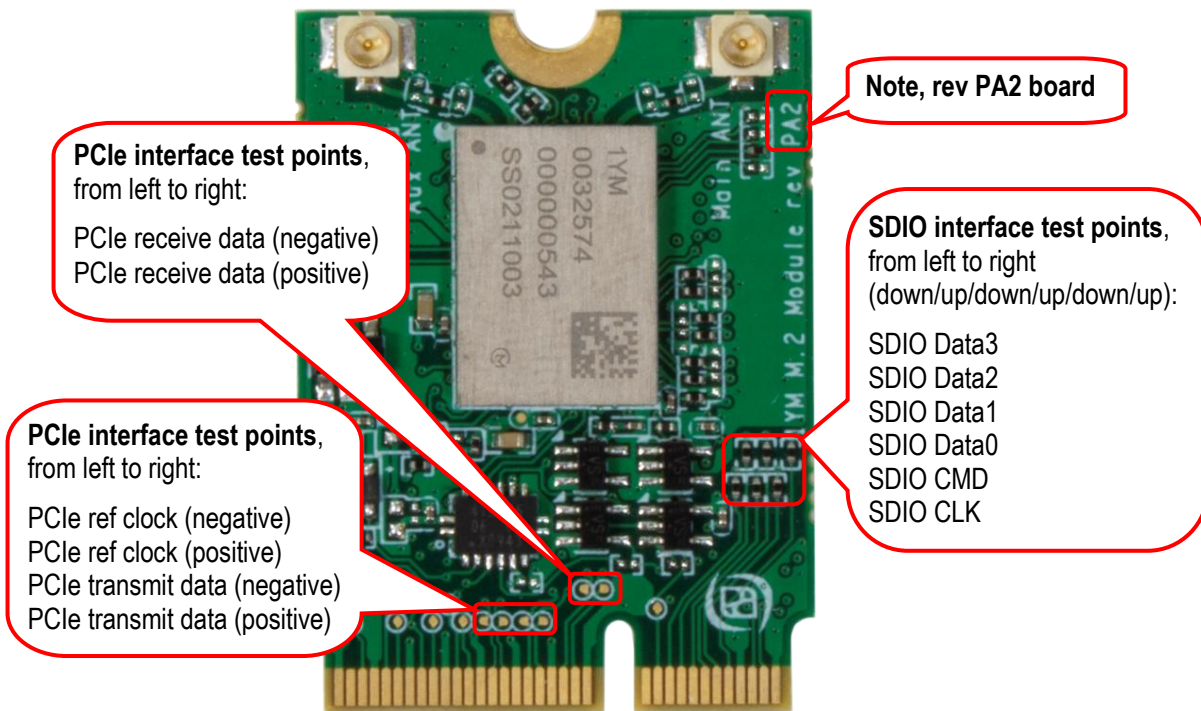

Figure 4 – 1YM M.2 Module PCIe and SDIO Test Points on rev PA2 Boards

3.8 Set SDIO Host Interface

The default interface for Wi-Fi is PCIe. It is possible to change this to the SDIO interface with a small rework, as described in the picture below.

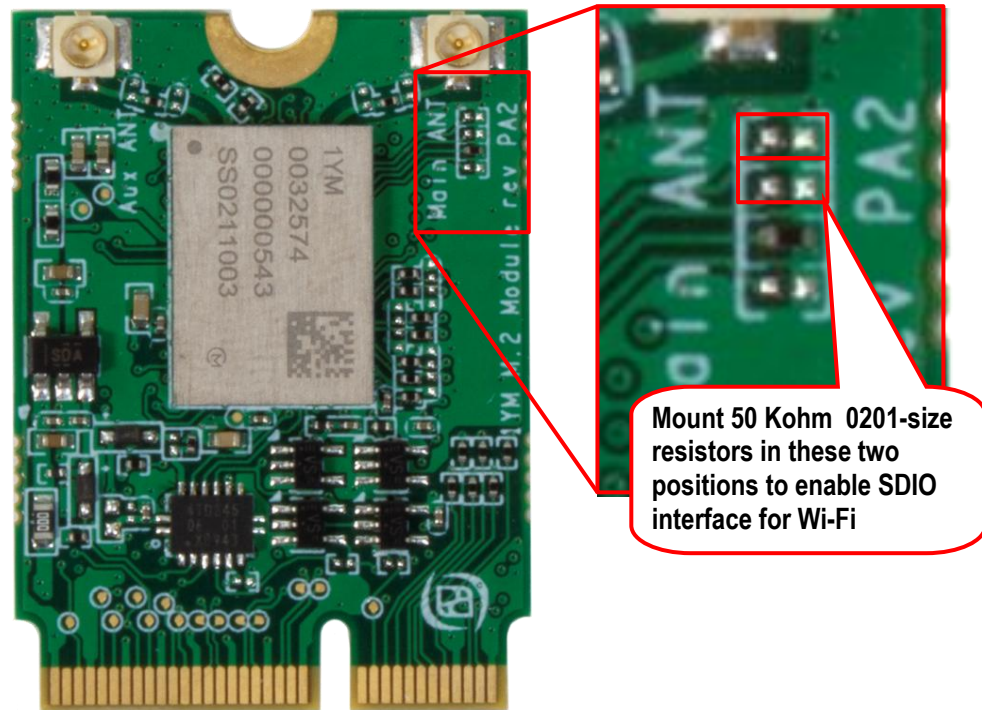

Figure 5 – 1YM M.2 Module Board Interface Configuration

Note: before deciding on using the SDIO interface, check availability of drivers for the host platform you are using

3.8.1 SDIO Clock Frequency Limit

Note: On rev PA2 boards the SDIO clock frequency must be limited to 100 MHz. On later revisions (rev A, or later) the SDIO clock frequency can be up to 200 MHz. The picture below illustrates where to locate the board revision information in the silk screen.

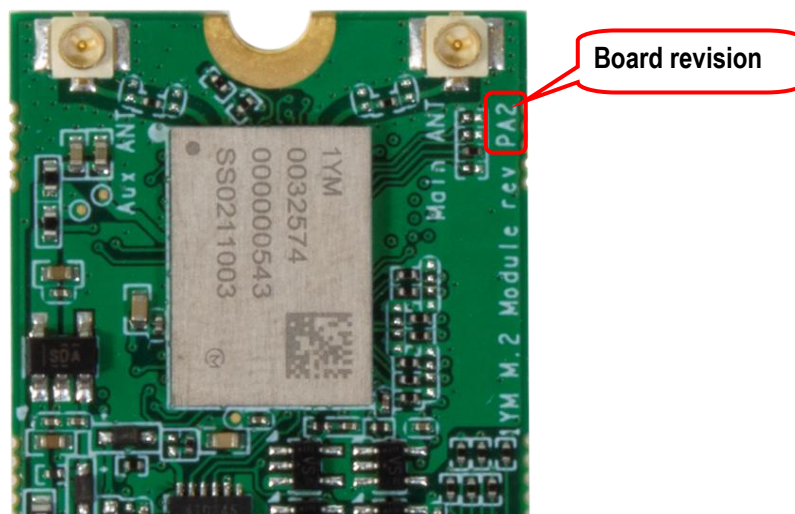

Figure 6 – 1YM M.2 Module Board Revision

3.9 Current Consumption Measurements

It is possible to measure the currents of the power supplies to the 1YM module, VBAT and VDDIO. VBAT is the 3.3V that is supplied to the M.2 interface and VDDIO is an on-board generated 1.8V. VDDIO is generated from the supplied 3.3V. If the supply voltage (3.3V) to the M.2 module is measured it will be both the VBAT and VDDIO currents that is measured. By measuring currents at the illustrated points below it is possible to measure VBAT and VDDIO. Note that VBAT is the total input current and includes the VDDIO current.

Note that zero ohm resistors are mounted by default. Select a series resistor with as low resistance as possible to keep the voltage drop to a minimum. Keep the drop below 100mV. VBAT can be slightly above 1 Amp in peak which means that maximum series resistance is 100 milliOhm for the VBAT resistor. For VDDIO the current is lower so a 1 ohm resistor can be a suitable value.

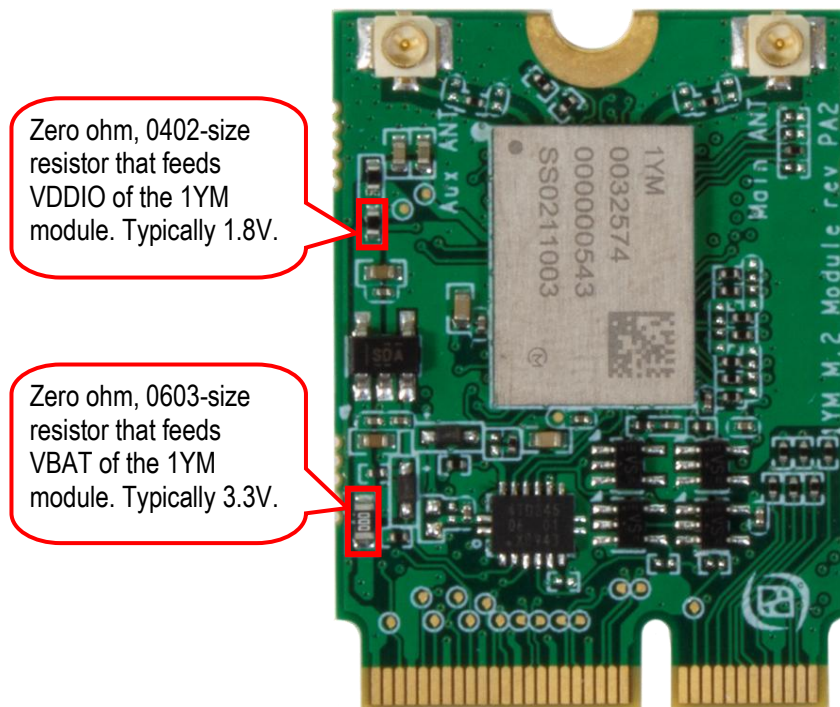

Figure 7 – Current Measurement

4 Antenna

The module does not have any on-board antenna because the module is too small to get spatial separation of the two antennas. Two external antennas must be connected (to support MIMO).

Molex 1461870100 is a balanced, dipole-type, high efficiency antenna used for the reference certification of the 1YM module. It is ground plane independent, dual band antenna that supports the 2400-2500MHz, 5150-5850MHz, 5925-7125MHz frequency bands. The physical size is 40.95 x 9 x 0.7mm. The antenna cable comes in 6 standard length options: 50/100/150/200/250/300mm (100mm is used for the reference certification) and the connector is MHF-I, which is a U.FL compatible connector.



Figure 8 – Reference Certified Antenna

4.1 Antenna Connector

The M.2 standard specifies a 1.5 mm outer ring diameter male connector, which is compatible with the Murata MSC and IPEX MHF4 connector specifications. This connector is not used since our M.2 modules also targets industrial users, where the Hirose U.FL. connector standard is more commonly used. U.FL. is compatible with the IPEX MHF1 connector specification.

5 Software and Support

This chapter contains information about software and support.

5.1 Software Driver

The 88W8997 chipset do not contain any persistent software. A firmware image must be downloaded by the host at start-up. This is the responsibility of the operating system driver.

There are three different cases, depending on which host processor is used:

1. **Embedded Artists' Computer-on-Modules, (u)COM, as host processor**

Embedded Artists' Linux BSPs and SDKs for the different (u)COM board contains all drivers available and pre-configured. Everything has been tested and works out-of-the-box on the different iMX Developer's Kits.

iMX Developer's Kit	1YM M.2 (PCIe) support	1YM M.2 (SDIO) support
iMX8M Mini uCOM	Yes, from Linux BSP v5.4.47	Not yet available
iMX8M Nano uCOM	No	Not yet available
iMX8M COM	Yes, from Linux BSP v5.4.47	Not yet available
iMX7 Dual COM	Yes, from Linux BSP v5.4.47	Not yet available
iMX7 Dual uCOM	Yes, from Linux BSP v5.4.47	Not yet available
iMX7ULP uCOM	No	No
iMX 6 Quad COM	Yes, from Linux BSP v5.4.47	Not yet available
iMX 6 DualLite COM	Yes, from Linux BSP v5.4.47	Not yet available
iMX 6 SoloX COM	Yes, from Linux BSP v5.4.47	Not yet available
iMX 6 UltraLite/ULL COM	No	Not yet available
iMX RT1176 uCOM	No	No
iMX RT1166 uCOM	No	No
iMX RT1064 uCOM	No	No
iMX RT1062 OEM	No	No

2. **Other i.MX based, for example NXP's EVKs**

Murata has created documentation how to compile the Linux kernel for the NXP EVKs
<https://wireless.murata.com/products/rf-modules-1/wi-fi-bluetooth-for-nxp-i-mx.html#Linux>

3. **Non-i.MX host processor**

There is no ready-to-go driver exist. Contact Murata to check driver availability on the hardware platform used.

5.2 Support

Embedded Artists supports customers that use our M.2 module in combination with Embedded Artists' Computer-on-Modules, (u)COM, based on NXP's i.MX RT/6/7/8 families.

For other platforms, support is provided by Murata via their Community Support Forum:

<https://community.murata.com/s/topic/0TO5F0000002TLWWA2/connectivity-modules>

6 Regulatory

The Murata 1YM module is reference certified. See the LBEE5XV1YM datasheet from Murata for details.

6.1 European Union Regulatory Compliance

EUROPEAN DECLARATION OF CONFORMITY (Simplified DoC per Article 10.9 of the Radio Equipment Directive 2014/53/EU)

This apparatus, namely 1YM M.2 module (pn EAR00370) conforms to the Radio Equipment Directive (RED) 2014/53/EU. The full EU Declaration of Conformity for this apparatus can be found at this location: <https://www.embeddedartists.com/products/1ym-m-2-module/>, see document *1YM M.2 module Declaration of Conformity*.

The following information is provided per Article 10.8 of the Radio Equipment Directive 2014/53/EU:

- (a) Frequency bands in which the equipment operates.
- (b) The maximum RF power transmitted.

PN	RF Technology	(a) Frequency Ranges (EU)	(b) Max Transmitted Power
EAR00370	Bluetooth BR/EDR/LE	2400 MHz – 2484 MHz	3.0 dBm (Molex 1461870100 antenna, 100 mm cable)
EAR00370	Wi-Fi IEEE 802.11b/g/n	2400 MHz – 2484 MHz	3.0 dBm (Molex 1461870100 antenna, 100 mm cable)
EAR00370	Wi-Fi IEEE 802.11a/n/ac	5150 MHz – 5850 MHz	4.0 dBm (Molex 1461870100 antenna, 100 mm cable)

The 1YM M.2 module comply with the Directive 2011/65/EU (EU RoHS 2) and its amendment Directive (EU) 2015/863 (EU RoHS 3).

7 Disclaimers

Embedded Artists reserves the right to make changes to information published in this document, including, without limitation, specifications and product descriptions, at any time and without notice. This document supersedes and replaces all information supplied prior to the publication hereof.

Customer is responsible for the design and operation of their applications and products using Embedded Artists' products, and Embedded Artists accepts no liability for any assistance with applications or customer product design. It is customer's sole responsibility to determine whether the Embedded Artists' product is suitable and fit for the customer's applications and products planned, as well as for the planned application and use of customer's third party customer(s). Customers should provide appropriate design and operating safeguards to minimize the risks associated with their applications and products. Customer is required to have expertise in electrical engineering and computer engineering for the installation and use of Embedded Artists' products.

Embedded Artists does not accept any liability related to any default, damage, costs or problem which is based on any weakness or default in the customer's applications or products, or the application or use by customer's third party customer(s). Customer is responsible for doing all necessary testing for the customer's applications and products using Embedded Artists' products in order to avoid a default of the applications and the products or of the application or use by customer's third party customer(s). Embedded Artists does not accept any liability in this respect.

Embedded Artists does not accept any liability for errata on individual components. Customer is responsible to make sure all errata published by the manufacturer of each component are taken note of. The manufacturer's advice should be followed.

Embedded Artists does not accept any liability and no warranty is given for any unexpected software behavior due to deficient components.

Customer is required to take note of manufacturer's specification of used components. Such specifications, if applicable, contains additional information that must be taken note of for the safe and reliable operation.

All Embedded Artists' products are sold pursuant to Embedded Artists' terms and conditions of sale: http://www.embeddedartists.com/sites/default/files/docs/General_Terms_and_Conditions.pdf

No license, express or implied, by estoppel or otherwise, to any intellectual property rights is granted under this document. If any part of this document refers to any third party products or services it shall not be deemed a license grant by Embedded Artists for the use of such third party products or services, or any intellectual property contained therein or considered as a warranty covering the use in any manner whatsoever of such third party products or services or any intellectual property contained therein.

UNLESS OTHERWISE SET FORTH IN EMBEDDED ARTISTS' TERMS AND CONDITIONS OF SALE EMBEDDED ARTISTS DISCLAIMS ANY EXPRESS OR IMPLIED WARRANTY WITH RESPECT TO THE USE AND/OR SALE OF EMBEDDED ARTISTS PRODUCTS INCLUDING WITHOUT LIMITATION IMPLIED WARRANTIES OF MERCHANTABILITY, FITNESS FOR A PARTICULAR PURPOSE (AND THEIR EQUIVALENTS UNDER THE LAWS OF ANY JURISDICTION), OR INFRINGEMENT OF ANY PATENT, COPYRIGHT OR OTHER INTELLECTUAL PROPERTY RIGHT.

UNLESS EXPRESSLY APPROVED IN WRITING BY THE CEO OF EMBEDDED ARTISTS, PRODUCTS ARE NOT RECOMMENDED, AUTHORIZED OR WARRANTED FOR USE IN MILITARY, AIR CRAFT, SPACE, NUCLEAR, LIFE SAVING, OR LIFE SUSTAINING APPLICATIONS, NOR IN PRODUCTS OR SYSTEMS WHERE FAILURE OR MALFUNCTION MAY RESULT IN PERSONAL INJURY, DEATH, OR SEVERE PROPERTY OR ENVIRONMENTAL DAMAGE.

Resale of Embedded Artists' products with provisions different from the statements and/or technical features set forth in this document shall immediately void any warranty granted by Embedded Artists

for the Embedded Artists' product or service described herein and shall not create or extend in any manner whatsoever, any liability of Embedded Artists.

This document as well as the item(s) described herein may be subject to export control regulations. Export might require a prior authorization from national authorities.

7.1 Definition of Document Status

Preliminary – The document is a draft version only. The content is still under internal review and subject to formal approval, which may result in modifications or additions. Embedded Artists does not give any representations or warranties as to the accuracy or completeness of information included herein and shall have no liability for the consequences of use of such information. The document is in this state until the product has passed Embedded Artists product qualification tests.

Approved – The information and data provided define the specification of the product as agreed between Embedded Artists and its customer, unless Embedded Artists and customer have explicitly agreed otherwise in writing.

Mouser Electronics

Authorized Distributor

Click to View Pricing, Inventory, Delivery & Lifecycle Information:

[Embedded Artists:](#)

[EAR00370](#)