



ritel

Drehknopf-Programm





RITEL-Knöpfe zeichnen sich durch Formschönheit, Griffigkeit, hohe Haltbarkeit und ein umfangreiches, farbiges Zubehörprogramm aus.

RITEL-Drehknöpfe besitzen vorgespannte Spannzangen! Die Schrauben müssen vor der Montage nicht mehr gelöst werden, nur noch aufstecken und anziehen.

Les boutons RITEL se caractérisent par leur présentation soignée, leur grande solidité, l'excellent maintien sur l'axe par fixation à pince de serrage et par un programme complet d'accessoires de couleurs variées.

Les boutons RITEL sont équipés de pinces de serrage à ressort! Il n'est nécessaire de desserrer aucune vis avant le montage, simplement enfoncer et serrer.

RITEL knobs are distinguished by their styling elegance, easy handling, long service life, excellent fit on the shaft as a result of clamping chuck mounting and by their comprehensive accessories program in different colours.

RITEL knobs have preloaded collets! No screws have to be loosened before fitting, push on and tighten only.



Die RITEL-Drehknöpfe sind in den Ausführungen «standard» und «mat finish» in vier Farben ab Lager lieferbar. Für die Deckel und Pfeile haben wir noch drei zusätzliche Farben ausgewählt. Alle Teile sind auch in Spezialfarben erhältlich.

Tous les modèles de boutons RITEL sont livrables en exécution «standard» et «mat finish» en quatre couleurs. Les capuchons et les disques à flèche existent en trois couleurs supplémentaires. Tous nos boutons et accessoires sont aussi à disposition en couleurs spéciales.

RITEL collet knobs are available in «standard» and «mat finish» in four colours. We have selected three additional colours for caps and arrows. All knobs and accessories are also at your disposal in a large range of special colours.

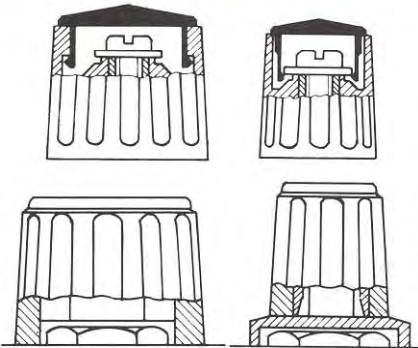

Die Deckel sind in drei Grundausführungen lieferbar: flach, Prismaform und bombiert. Die flachen Deckel mit zusätzlich aufgeprägtem Strich, Pfeil, Schwellpfeil oder mit eingelegter Aluminiumscheibe; die Prismadeckel mit aufgeprägtem Punkt; die bombierten Deckel mit Strich. Die Deckel sind so konstruiert, dass sie bei der Montage im Knopf einrasten und dadurch unverlierbar sind.

Les capuchons sont livrables en trois exécutions de base: Modèle plat, forme prismatique et forme courbée. Les capuchons plats sont aussi fabriqués avec des repères: trait, flèche, flèche coudée ou avec disque aluminium; les capuchons prismatiques avec point; les capuchons courbés avec trait. Les capuchons sont munis d'un encliquetage qui se verrouille dans le bouton lors du montage.

Caps are sold in three basic models: flat, prismatic or curved. The flat cap can also be furnished with indicator line, arrow, curved arrow or with aluminium disk, the prismatic cap with distinctive point and the curved cap with indicator line. Caps snap into a secure position in the knob.

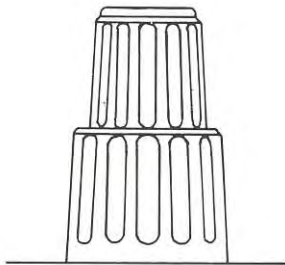

Die Knopfgrößen 21 mm, 28 mm, 36 mm und 45 mm besitzen Aussparungen für Befestigungsmuttern, für 10 mm, 13 mm und 15 mm gibt es Mutterabdeckungen.

Les boutons de diamètre 21 mm, 28 mm, 36 mm et 45 mm possèdent un dégagement pour l'écrou. Ils existent des jupes pour les diamètres de 10, 13 et de 15 mm.

The 21 mm, 28 mm, 36 mm and 45 mm knob sizes have recesses for nuts. For the 10, 13 and 15 mm sizes nut covers are available.

Drehknöpfe mit durchgehender Spannzange für Doppelknöpfe sind ebenfalls lieferbar. Nähere Angaben finden Sie auf den Seiten 30 und 31.

Les boutons doubles avec pince de serrage pour axes coaxiaux sont aussi livrables, vous trouverez les détails aux pages 30 et 31.

Knobs with coaxial collet for double knobs are also available. Detailed information on pages 30 and 31.

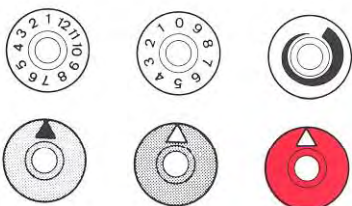

Eine grosse Anzahl von Zahlenscheiben für Rastereinstellungen für 27°40', 30°, 36° und 60°, sowie farbige Scheiben ersparen Ihnen teure Sonderanfertigungen.

Le grand choix de cadrans gravés pour angles de positionnement de 27°40', 30°, 36° et 60° vous évite la réalisation de platines frontales coûteuses.

A large selection of figure dials for indexing angles of 27°40', 30°, 36° and 60° together with coloured disks dispense with the need for expensive manufacture of special units.



Die in acht Farben lieferbaren RITEL-Industrieklemmen sind eine Ergänzung zum RITEL-Drehknopfprogramm.

Les pinces industrielles RITEL, livrables en huit couleurs, constituent une extension du programme de boutons RITEL.

The RITEL industrial terminal, available in eight colours, is a supplement to the RITEL range of knobs.

Vielleicht finden Sie trotz des umfangreichen Sortiments «Ihren» Knopf nicht in unserem Programm. Wir sind gerne bereit, Ihnen Spezialknöpfe oder Zubehörteile nach Ihren Zeichnungen oder Ihren Mustern zu offerieren.

Si malgré la grande étendue de notre assortiment vous ne trouvez pas «Votre» bouton dans notre programme, nous vous offrirons volontiers une exécution spéciale conforme à vos dessins ou échantillons.

If you did not find «your» particular knob in our vast collection, please do not hesitate to contact us. We shall be pleased to offer you special knobs and accessories to your specifications.

Knopf
Bouton
Knob

Knebelknopf
Bouton à oreilles
Wing knob

Pfeilknopf
Bouton à flèche
Arrow knob

8 mm



10 mm



13 mm



15 mm



21 mm



28 mm



36 mm



45 mm



Inhalt

Seite

Einführung	2, 3, 4, 5
Drehmomente	5
Spez. Zubehör	6
Knopf, Deckel	8, 7
	10, 8, 9
	13, 10, 11
	15, 12, 13
	21, 14, 15
	28, 16, 17
	36, 18, 19
	45, 20, 21
Statoren	26, 27
Zahlenscheiben	26, 27
Pfeilscheiben	26, 27
Pfeile	28
Mutterabd.	29
Kurzknöpfe	15, 22, 23
	21, 24, 25, 26
	28, 24, 25, 26
	36, 24, 25, 26
Knöpfe mit durchgehender Spann.	30
Doppelknöpfe	31
Zwischendeckel	31
Steckknöpfe	32, 33
Industrieklemmen	34
Industrieklemmen berührungssicher	35
Introduction	2, 3, 4, 5
Couples	5
Accessoires spéciaux	6
Bouton, couvercle	8, 7
	10, 8, 9
	13, 10, 11
	15, 12, 13
	21, 14, 15
	28, 16, 17
	36, 18, 19
	45, 20, 21
Stators	26, 27
Cadrans	26, 27
Disques à flèche	26, 27
Flèches	28
Couvre-écrous	29
Boutons courts	15, 22, 23
	21, 24, 25, 26
	28, 24, 25, 26
	36, 24, 25, 26
Boutons avec pince de serrage traversante	30
Boutons doubles	31
Couvercles intermédiaires	31
Boutons embrochables	32, 33
Bornes industrielles	34
Bornes industrielles protégées contre le toucher	35
Introduction	2, 3, 4, 5
Torques	5
Spec. accessories	6
Knob, cover	8, 7
	10, 8, 9
	13, 10, 11
	15, 12, 13
	21, 14, 15
	28, 16, 17
	36, 18, 19
	45, 20, 21
Stators	26, 27
Number wheels	26, 27
Arrow plates	26, 27
Arrows	28
Nut cover	29
Short knobs	15, 22, 23
	21, 24, 25, 26
	28, 24, 25, 26
	36, 24, 25, 26
Knobs with continuous collet	30
Double knobs	31
Intermediate cover	31
Push-on knobs	32, 33
Industrial terminals	34
Industrial terminals shockproof	35

Kurzknopf

Bouton court
Short knob

15 mm



21 mm



28 mm

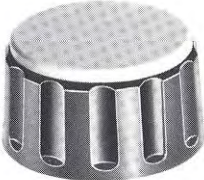

36 mm



Material

Für das Programm «standard» und «mat finish» verwenden wir Polyamid.
Für die transparenten Zahlenscheiben wird PC verwendet. Für Spannzangen, Spannhülsen und Muttern verwenden wir Messing 58. Schrauben und Unterlagscheiben sind aus Stahl promatisiert.

Temperaturbeständigkeit

Bei normaler mechanischer Belastung:
-20° bis +70° C.

Kurzkebelknopf

Bouton court à oreilles
Short wing knob

15 mm



21 mm



28 mm



36 mm



Matériel

Tous les types du programme «standard» et «mat finish» sont en Polyamid.
Les cadrans transparents sont en PC. Les pinces de serrages, leurs douilles et leurs écrous sont en laiton MS 58. La surface des vis et rondelles est protégée contre la corrosion.

Stabilité de température

Pour des exigences mécaniques normales:
-20° à +70° C.

Das RITEL-Kurzknopfprogramm

Der RITEL-Kurzknopf ist um 20% kürzer und an das bestehende Knopfprogramm angepasst. Es ist besonders für den modernen Gerätebau geeignet. Sämtliche Spannzangen dieser Knöpfe haben Bohrungen für durchgehende Achsen. Die Montage erfolgt mit einem handelsüblichen 6 kt. Steckschlüssel.

La gamme RITEL des boutons courts

Le bouton court RITEL présente une longueur réduite de 20% et est assimilé au programme existant. Il est particulièrement adapté aux besoins de la construction d'appareils modernes. L'ensemble des pinces de serrage de ces boutons comporte des ouvertures destinées au montage coaxial. L'assemblage est fait à l'aide d'une clé à tube à six pans couramment trouvée dans le commerce.

The RITEL short-knob program

The RITEL short knob has a length reduced by about 20%. It is adapted to the existing knob program. It is particularly appropriate for the necessities of modern instrument construction. All collets of these knobs have drill holes for coaxial mounting. Mounting is done with a commercial, hexagonal box spanner.

Material

Polyamide is used for the «standard» and «mat finish» program.
The transparent dials are made of PC. Brass 58 is used for the collets, sleeves and nuts. The surface of screws and washers is protected against corrosion.
PC = Polycarbonat

Temperature stability

For normal mechanical stress:
-20° to +70° C.

Free-Drive-Schrauben

RITEL-Drehknöpfe werden mit Free-Drive-Schrauben montiert. Diese Schrauben sind eine Kombination zwischen Schrauben mit normalem Schlitz und den Philips-Kreuzschlitzschrauben. Die Free-Drive-Schrauben können somit wahlweise mit einem Kreuzschlitz- oder normalen Schraubenzieher festgezogen werden.

Vis free-drive

Les boutons RITEL sont montés avec des vis free-drive. Ces vis représentent une combinaison entre les vis à fente ordinaire et les vis à fente en croix Philips. Les vis free-drive peuvent être serrées selon le choix à l'aide d'un tournevis à 4 pans ou d'un tournevis ordinaire.

Free-drive screws

RITEL knobs are mounted with free-drive screws. These screws are the combination or ordinary one-slot screws and the Philips cross-slot screws. The free-drive screws can be tightened optionally using a screwdriver for Philips screws or an ordinary screwdriver.

RITEL-Drehknöpfe haben vorgespannte Spann-
zangen!
Die Schrauben müssen vor der Montage nicht
mehr gelöst werden, nur noch aufstecken und an-
ziehen.

Les boutons RITEL sont équipés de pinces de
serrage à ressort!
Il n'est nécessaire de desserrer aucune vis avant le
montage, simplement enfoncer et serrer.

RITEL knobs have preloaded collets! No screws
have to be loosened before fitting, push on and
tighten only.

Lieferbare Spann- zangen

Pincas de serrage livrables
Collets available

Knopf Spann- zange, vorgespannt

Bouton
Knob

durchgehend, nicht vorgespannt
traversant, sans précontrainte
coaxial, not preloaded

	2	3	1/8	4	5	5,2	6	1/4	8	10	3	1/8	4	6	1/4
8	×	×	×	×											
10	×	×	×	×											
13	×	×	×	×			×	×			×	×	×	×	×
15	×	×	×	×	×	×	×	×			×	×	×	×	×
21		×	×	×	×	×	×	×			×	×	×	×	×
28		×	×	×	×	×	×	×	×	×	×	×	×	×	×
36		×	×	×	×	×	×	×	×	×	×	×	×	×	×
45		×	×	×	×	×	×	×	×	×	×	×	×	×	×

Die mit ×* bezeichneten Spann-
zangen sind nur in kleineren Stückzahlen vorrätig, bei grösserem Bedarf bitte Termin anfragen.

Les pinces de serrage marquées d'un × ne sont en stock qu'en nombre limité. En cas de besoins importants, prière de demander le délai de livraison.

The collets marked with ×* are only stocked in small quantities. Enquire for delivery date in the case of large orders.

Drehmoment

Couple
Torque

Spannzange Pince de serrage Collet	Knopf Bouton Knob	Montage-Drehmoment Couple de fixation Assembly torque	Funktions-Drehmoment Couple de fonctionnement Operation torque
ø	ø	cm/kg	cm/kg
3, 1/8", 4	8-10	3	3
3, 1/8", 4	13-45	8	6
6, 1/4"	13-45	18	16
8	28-45	30	20
10	28-45	35	25

Die angegebenen Funktions-Drehmomente beziehen sich auf handelsübliche Stahlachsen H8.

BITTE BEACHTEN: Beim Einsatz von Spann-
zangen-Knöpfen auf Kunststoffachsen sind Versuche vorzunehmen. RITEL AG übernimmt keine Garantie
bei dieser Anwendungsart. Kunststoffachsen neigen zu Kaltfluss.

Les couples de fonctionnement indiqués se rapportent à des axes usuels en acier H8.

PRIÈRE DE REMARQUER: dans le cas d'utilisation de boutons de pinces de serrage sur des axes en plastique, il faut réaliser des essais. RITEL SA ne
supporte aucune garantie dans ce genre d'utilisation. Les axes en plastique ont tendance à fluer.

The stated operation torques refer to standard steel spindles H8.

PLEASE NOTE: Trials must be carried out when using collet knobs on plastic spindles. No guarantee is given by RITEL AG for this application method.
Plastic spindles have a tendency to cold flow.

Steckschlüssel – Clé – Box spanner

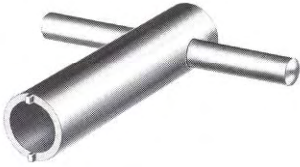

49 15 00 0

Schlitzmutter – Ecrou rond – Slotted nut

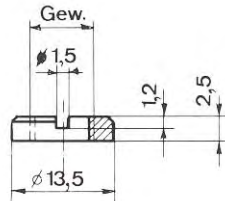

Gewinde	M 10×0,75	49 15 10 0
Filetage	3/8–32	49 15 95 0
Thread		

Verdrehungsschutz – Dispositif antirotatoire – locking-device

Verdrehungsschutz für 6 mm und 1/4" Achsen (DIN 41591)
Erhältlich nur für Knöpfe Ø 21, 28, 36 und 45 mm

Dispositif antirotatoire pour axes de 6 mm et 1/4" (DIN 41591)
Livrabte seulement pour boutons de 21, 28, 36 et 45 mm de Ø

Locking-device for 6 mm and 1/4" axles (DIN 41591)
Available only for knobs of 21, 28, 36 and 45 mm of Ø

Der RITEL-Verdrehungsschutz für 6 mm und 1/4" Achsen

Der RITEL-Verdrehungsschutz ist ein separat in den Knopf einzupressendes Stanzteil, welches dem Spannzangenknopf eine exakte Positionierung sowie ein erhöhtes Drehmoment gibt.

Erhältlich für Knöpfe Ø 21, 28, 36 und 45 mm

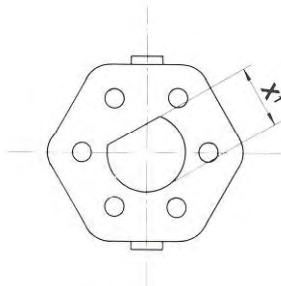

Dispositif antirotatoire pour axes de 6 mm et de 1/4"

Le dispositif antirotatoire RITEL est une pièce découpée devant être pressée séparément dans le bouton et conférant au bouton à pince de serrage un positionnement précis ainsi qu'un couple plus élevé.

Livrabte pour boutons de 21, 28, 36 et 45 mm de Ø

Locking-device for 6 mm and 1/4" axles

The RITEL locking-device is a punched part to be pressed separately into the knob, allowing an accurate positioning of the collet knob and giving it an increased torque.

Available for knobs of 21, 28, 36 and 45 mm of Ø

Achsen

axes
axles x¹

6 mm	5,0	49 15 60 0
1/4"	5,08	49 15 61 0

Knopf Bouton Knob

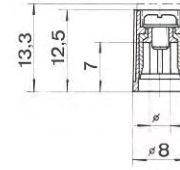

standard
mat finish

0
3
1/8"
4
3
1/8"
4

20 08 30 1	20 08 30 2	20 08 30 3	20 08 30 4
20 08 31 1	20 08 31 2	20 08 31 3	20 08 31 4
20 08 40 1	20 08 40 2	20 08 40 3	20 08 40 4
26 08 30 1	26 08 30 2	26 08 30 3	26 08 30 4
26 08 31 1	26 08 31 2	26 08 31 3	26 08 31 4
26 08 40 1	26 08 40 2	26 08 40 3	26 08 40 4

mit Strich – avec repère – with line

21 08 30 1	21 08 30 2	21 08 30 3	21 08 30 4
21 08 31 1	21 08 31 2	21 08 31 3	21 08 31 4
21 08 40 1	21 08 40 2	21 08 40 3	21 08 40 4
27 08 30 1	27 08 30 2	27 08 30 3	27 08 30 4
27 08 31 1	27 08 31 2	27 08 31 3	27 08 31 4
27 08 40 1	27 08 40 2	27 08 40 3	27 08 40 4

Knebelknopf Bouton à oreilles Wing knob

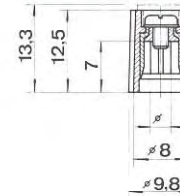

standard
mat finish

0
3
1/8"
4
3
1/8"
4

22 08 30 1	22 08 30 2	22 08 30 3	22 08 30 4
22 08 31 1	22 08 31 2	22 08 31 3	22 08 31 4
22 08 40 1	22 08 40 2	22 08 40 3	22 08 40 4
28 08 30 1	28 08 30 2	28 08 30 3	28 08 30 4
28 08 31 1	28 08 31 2	28 08 31 3	28 08 31 4
28 08 40 1	28 08 40 2	28 08 40 3	28 08 40 4

mit Strich – avec repère – with line

23 08 30 1	23 08 30 2	23 08 30 3	23 08 30 4
23 08 31 1	23 08 31 2	23 08 31 3	23 08 31 4
23 08 40 1	23 08 40 2	23 08 40 3	23 08 40 4
29 08 30 1	29 08 30 2	29 08 30 3	29 08 30 4
29 08 31 1	29 08 31 2	29 08 31 3	29 08 31 4
29 08 40 1	29 08 40 2	29 08 40 3	29 08 40 4



Deckel flach – Capuchon plat – Flat cap

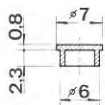

mit Strich
avec trait
with line

standard
mat finish

30 08 00 1	30 08 00 2	30 08 00 3	30 08 00 4	30 08 00 5	30 08 00 6	30 08 00 7
30 08 10 1	30 08 10 2	30 08 10 3	30 08 10 4	30 08 10 5	30 08 10 6	30 08 10 7

mit Schwellpfeil
avec flèche coudée
with curved arrow

standard
mat finish

30 08 01 1	30 08 01 2	30 08 01 3	30 08 01 4	30 08 01 5	30 08 01 6	30 08 01 7
30 08 11 1	30 08 11 2	30 08 11 3	30 08 11 4	30 08 11 5	30 08 11 6	30 08 11 7

30 08 02 1	30 08 02 2	30 08 02 3	30 08 02 4	30 08 02 5	30 08 02 6	30 08 02 7
30 08 12 1	30 08 12 2	30 08 12 3	30 08 12 4	30 08 12 5	30 08 12 6	30 08 12 7

mit Pfeil
avec flèche
with arrow

standard
mat finish

30 08 03 1	30 08 03 2	30 08 03 3	30 08 03 4	30 08 03 5	30 08 03 6	30 08 03 7
30 08 13 1	30 08 13 2	30 08 13 3	30 08 13 4	30 08 13 5	30 08 13 6	30 08 13 7

Knopf
Bouton
Knob

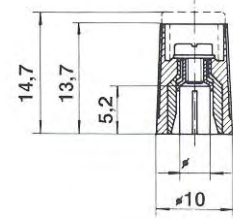

mit Strich – avec repère – with line

	20 10 30 1	20 10 30 2	20 10 30 3	20 10 30 4		
standard	3	20 10 31 1	20 10 31 2	20 10 31 3	20 10 31 4	
	1/8"	4	20 10 40 1	20 10 40 2	20 10 40 3	20 10 40 4
mat finish	3	26 10 30 1	26 10 30 2	26 10 30 3	26 10 30 4	
	1/8"	4	26 10 31 1	26 10 31 2	26 10 31 3	26 10 31 4
			26 10 40 1	26 10 40 2	26 10 40 3	26 10 40 4

	21 10 30 1	21 10 30 2	21 10 30 3	21 10 30 4
	21 10 31 1	21 10 31 2	21 10 31 3	21 10 31 4
	21 10 40 1	21 10 40 2	21 10 40 3	21 10 40 4
	27 10 30 1	27 10 30 2	27 10 30 3	27 10 30 4
	27 10 31 1	27 10 31 2	27 10 31 3	27 10 31 4
	27 10 40 1	27 10 40 2	27 10 40 3	27 10 40 4

Knebelknopf
Bouton à oreilles
Wing knob

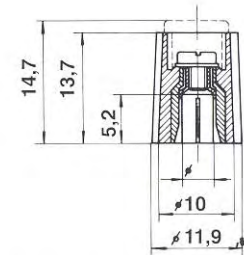

mit Strich – avec repère – with line

	22 10 30 1	22 10 30 2	22 10 30 3	22 10 30 4		
standard	3	22 10 31 1	22 10 31 2	22 10 31 3	22 10 31 4	
	1/8"	4	22 10 40 1	22 10 40 2	22 10 40 3	22 10 40 4
mat finish	3	28 10 30 1	28 10 30 2	28 10 30 3	28 10 30 4	
	1/8"	4	28 10 31 1	28 10 31 2	28 10 31 3	28 10 31 4
			28 10 40 1	28 10 40 2	28 10 40 3	28 10 40 4

	23 10 30 1	23 10 30 2	23 10 30 3	23 10 30 4
	23 10 31 1	23 10 31 2	23 10 31 3	23 10 31 4
	23 10 40 1	23 10 40 2	23 10 40 3	23 10 40 4
	29 10 30 1	29 10 30 2	29 10 30 3	29 10 30 4
	29 10 31 1	29 10 31 2	29 10 31 3	29 10 31 4
	29 10 40 1	29 10 40 2	29 10 40 3	29 10 40 4

Pfeilknopf
Bouton à flèche
Arrow knob

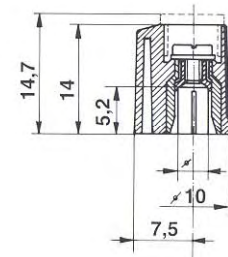

mit Strich – avec repère – with line

	18 10 30 1	18 10 30 2	18 10 30 3	18 10 30 4		
standard	3	18 10 31 1	18 10 31 2	18 10 31 3	18 10 31 4	
	1/8"	4	18 10 40 1	18 10 40 2	18 10 40 3	18 10 40 4
mat finish	3	16 10 30 1	16 10 30 2	16 10 30 3	16 10 30 4	
	1/8"	4	16 10 31 1	16 10 31 2	16 10 31 3	16 10 31 4
			16 10 40 1	16 10 40 2	16 10 40 3	16 10 40 4

	19 10 30 1	19 10 30 2	19 10 30 3	19 10 30 4
	19 10 31 1	19 10 31 2	19 10 31 3	19 10 31 4
	19 10 40 1	19 10 40 2	19 10 40 3	19 10 40 4
	17 10 30 1	17 10 30 2	17 10 30 3	17 10 30 4
	17 10 31 1	17 10 31 2	17 10 31 3	17 10 31 4
	17 10 40 1	17 10 40 2	17 10 40 3	17 10 40 4

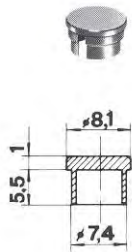

mit Strich
avec trait
with line

Deckel flach — Capuchon plat — Flat cap

standard	30 10 00 1	30 10 00 2	30 10 00 3	30 10 00 4	30 10 00 5	30 10 00 6
mat finish	30 10 10 1	30 10 10 2	30 10 10 3	30 10 10 4	30 10 10 5	30 10 10 6

standard	30 10 01 1	30 10 01 2	30 10 01 3	30 10 01 4	30 10 01 5	30 10 01 6
mat finish	30 10 11 1	30 10 11 2	30 10 11 3	30 10 11 4	30 10 11 5	30 10 11 6

mit Schwellpfeil
avec flèche coudée
with curved arrow

standard	30 10 02 1	30 10 02 2	30 10 02 3	30 10 02 4	30 10 02 5	30 10 02 6
mat finish	30 10 12 1	30 10 12 2	30 10 12 3	30 10 12 4	30 10 12 5	30 10 12 6

mit Pfeil
avec flèche
with arrow

standard	30 10 03 1	30 10 03 2	30 10 03 3	30 10 03 4	30 10 03 5	30 10 03 6
mat finish	30 10 13 1	30 10 13 2	30 10 13 3	30 10 13 4	30 10 13 5	30 10 13 6

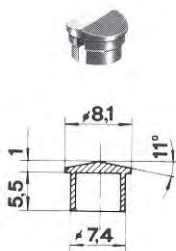

mit Punkt
avec point
with point

Deckel prismaform — Capuchon prismatique — Prismatic cap

standard	31 10 00 1	31 10 00 2	31 10 00 3	31 10 00 4	31 10 00 5	31 10 00 6
mat finish	31 10 10 1	31 10 10 2	31 10 10 3	31 10 10 4	31 10 10 5	31 10 10 6

standard	31 10 04 1	31 10 04 2	31 10 04 3	31 10 04 4	31 10 04 5	31 10 04 6
mat finish	31 10 14 1	31 10 14 2	31 10 14 3	31 10 14 4	31 10 14 5	31 10 14 6

Deckel bombiert — Capuchon courbé — Curved cap

standard	32 10 00 1	32 10 00 2	32 10 00 3	32 10 00 4	32 10 00 5	32 10 00 6
mat finish	32 10 10 1	32 10 10 2	32 10 10 3	32 10 10 4	32 10 10 5	32 10 10 6

standard	32 10 01 1	32 10 01 2	32 10 01 3	32 10 01 4	32 10 01 5	32 10 01 6
mat finish	32 10 11 1	32 10 11 2	32 10 11 3	32 10 11 4	32 10 11 5	32 10 11 6

mit Strich
avec trait
with line

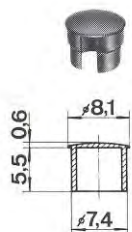

Deckel flach — Capuchon plat — Flat cap

standard	35 10 00 1	35 10 00 2	35 10 00 3
mat finish	35 10 10 1	35 10 10 2	35 10 10 3

mit Aluminium-Scheibe
avec disque aluminium
with aluminium disk

standard	35 10 01 1	35 10 01 2	35 10 01 3
mat finish	35 10 11 1	35 10 11 2	35 10 11 3

mit Alu-Scheibe und Strich
avec disque alu et repère
with alu disk and line

Knopf

Bouton
Knob

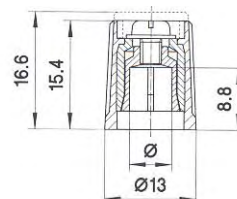

standard

Ø
3
1/8"
4
6
1/4"



20 13 30 1	20 13 30 2	20 13 30 3	20 13 30 4
20 13 31 1	20 13 31 2	20 13 31 3	20 13 31 4
20 13 40 1	20 13 40 2	20 13 40 3	20 13 40 4
20 13 60 1	20 13 60 2	20 13 60 3	20 13 60 4
20 13 61 1	20 13 61 2	20 13 61 3	20 13 61 4
26 13 30 1	26 13 30 2	26 13 30 3	26 13 30 4
26 13 31 1	26 13 31 2	26 13 31 3	26 13 31 4
26 13 40 1	26 13 40 2	26 13 40 3	26 13 40 4
26 13 60 1	26 13 60 2	26 13 60 3	26 13 60 4
26 13 61 1	26 13 61 2	26 13 61 3	26 13 61 4

mat finish

3
1/8"
4
6
1/4"

21 13 30 1	21 13 30 2	21 13 30 3	21 13 30 4
21 13 31 1	21 13 31 2	21 13 31 3	21 13 31 4
21 13 40 1	21 13 40 2	21 13 40 3	21 13 40 4
21 13 60 1	21 13 60 2	21 13 60 3	21 13 60 4
21 13 61 1	21 13 61 2	21 13 61 3	21 13 61 4
27 13 30 1	27 13 30 2	27 13 30 3	27 13 30 4
27 13 31 1	27 13 31 2	27 13 31 3	27 13 31 4
27 13 40 1	27 13 40 2	27 13 40 3	27 13 40 4
27 13 60 1	27 13 60 2	27 13 60 3	27 13 60 4
27 13 61 1	27 13 61 2	27 13 61 3	27 13 61 4

mit Strich – avec repère – with line



21 13 30 1	21 13 30 2	21 13 30 3	21 13 30 4
21 13 31 1	21 13 31 2	21 13 31 3	21 13 31 4
21 13 40 1	21 13 40 2	21 13 40 3	21 13 40 4
21 13 60 1	21 13 60 2	21 13 60 3	21 13 60 4
21 13 61 1	21 13 61 2	21 13 61 3	21 13 61 4
27 13 30 1	27 13 30 2	27 13 30 3	27 13 30 4
27 13 31 1	27 13 31 2	27 13 31 3	27 13 31 4
27 13 40 1	27 13 40 2	27 13 40 3	27 13 40 4
27 13 60 1	27 13 60 2	27 13 60 3	27 13 60 4
27 13 61 1	27 13 61 2	27 13 61 3	27 13 61 4

Knebelknopf

Bouton à oreilles
Wing knob

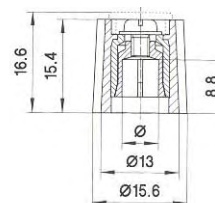

standard

Ø
3
1/8"
4
6
1/4"



22 13 30 1	22 13 30 2	22 13 30 3	22 13 30 4
22 13 31 1	22 13 31 2	22 13 31 3	22 13 31 4
22 13 40 1	22 13 40 2	22 13 40 3	22 13 40 4
22 13 60 1	22 13 60 2	22 13 60 3	22 13 60 4
22 13 61 1	22 13 61 2	22 13 61 3	22 13 61 4
28 13 30 1	28 13 30 2	28 13 30 3	28 13 30 4
28 13 31 1	28 13 31 2	28 13 31 3	28 13 31 4
28 13 40 1	28 13 40 2	28 13 40 3	28 13 40 4
28 13 60 1	28 13 60 2	28 13 60 3	28 13 60 4
28 13 61 1	28 13 61 2	28 13 61 3	28 13 61 4

mat finish

3
1/8"
4
6
1/4"

23 13 30 1	23 13 30 2	23 13 30 3	23 13 30 4
23 13 31 1	23 13 31 2	23 13 31 3	23 13 31 4
23 13 40 1	23 13 40 2	23 13 40 3	23 13 40 4
23 13 60 1	23 13 60 2	23 13 60 3	23 13 60 4
23 13 61 1	23 13 61 2	23 13 61 3	23 13 61 4
29 13 30 1	29 13 30 2	29 13 30 3	29 13 30 4
29 13 31 1	29 13 31 2	29 13 31 3	29 13 31 4
29 13 40 1	29 13 40 2	29 13 40 3	29 13 40 4
29 13 60 1	29 13 60 2	29 13 60 3	29 13 60 4
29 13 61 1	29 13 61 2	29 13 61 3	29 13 61 4

mit Strich – avec repère – with line



23 13 30 1	23 13 30 2	23 13 30 3	23 13 30 4
23 13 31 1	23 13 31 2	23 13 31 3	23 13 31 4
23 13 40 1	23 13 40 2	23 13 40 3	23 13 40 4
23 13 60 1	23 13 60 2	23 13 60 3	23 13 60 4
23 13 61 1	23 13 61 2	23 13 61 3	23 13 61 4
29 13 30 1	29 13 30 2	29 13 30 3	29 13 30 4
29 13 31 1	29 13 31 2	29 13 31 3	29 13 31 4
29 13 40 1	29 13 40 2	29 13 40 3	29 13 40 4
29 13 60 1	29 13 60 2	29 13 60 3	29 13 60 4
29 13 61 1	29 13 61 2	29 13 61 3	29 13 61 4

13-mm-Knopf auch mit durchgehender Spannzange erhältlich. Siehe Seite 30.

Le bouton de 13 mm est aussi livrable avec pince de serrage coaxial. Voir page 30.

The 13 mm knob is also available with coaxial collet. See page 30.

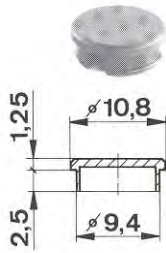

Deckel flach – Capuchon plat – Flat cap

mit Strich
avec trait
with line

standard
mat finish



standard
mat finish



mit Schwellpfeil
avec flèche coudée
with curved arrow

standard
mat finish



mit Pfeil
avec flèche
with arrow

standard
mat finish

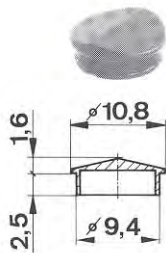

Deckel prismaform – Capuchon prismatique – Prismatic cap

mit Punkt
avec point
with point

standard
mat finish

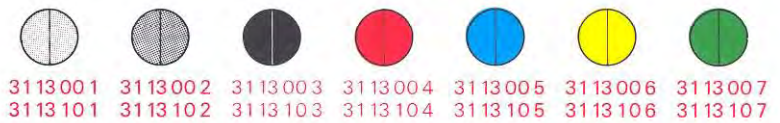

standard
mat finish

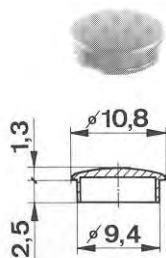

Deckel bombiert – Capuchon courbé – Curved cap

mit Strich
avec trait
with line

standard
mat finish



standard
mat finish



Knopf Bouton Knob

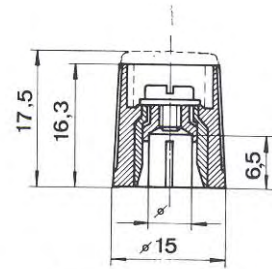

mit Strich – avec repère – with line

	φ				
standard	3	20 15 30 1	20 15 30 2	20 15 30 3	20 15 30 4
	1/8"	20 15 31 1	20 15 31 2	20 15 31 3	20 15 31 4
	4	20 15 40 1	20 15 40 2	20 15 40 3	20 15 40 4
	6	20 15 60 1	20 15 60 2	20 15 60 3	20 15 60 4
	1/4"	20 15 61 1	20 15 61 2	20 15 61 3	20 15 61 4
mat finish	3	26 15 30 1	26 15 30 2	26 15 30 3	26 15 30 4
	1/8"	26 15 31 1	26 15 31 2	26 15 31 3	26 15 31 4
	4	26 15 40 1	26 15 40 2	26 15 40 3	26 15 40 4
	6	26 15 60 1	26 15 60 2	26 15 60 3	26 15 60 4
	1/4"	26 15 61 1	26 15 61 2	26 15 61 3	26 15 61 4

standard	21 15 30 1	21 15 30 2	21 15 30 3	21 15 30 4
	21 15 31 1	21 15 31 2	21 15 31 3	21 15 31 4
	21 15 40 1	21 15 40 2	21 15 40 3	21 15 40 4
	21 15 60 1	21 15 60 2	21 15 60 3	21 15 60 4
	21 15 61 1	21 15 61 2	21 15 61 3	21 15 61 4
mat finish	27 15 30 1	27 15 30 2	27 15 30 3	27 15 30 4
	27 15 31 1	27 15 31 2	27 15 31 3	27 15 31 4
	27 15 40 1	27 15 40 2	27 15 40 3	27 15 40 4
	27 15 60 1	27 15 60 2	27 15 60 3	27 15 60 4
	27 15 61 1	27 15 61 2	27 15 61 3	27 15 61 4

Knebelknopf Bouton à oreilles Wing knob

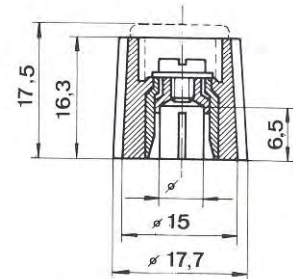

mit Strich – avec repère – with line

	φ				
standard	3	22 15 30 1	22 15 30 2	22 15 30 3	22 15 30 4
	1/8"	22 15 31 1	22 15 31 2	22 15 31 3	22 15 31 4
	4	22 15 40 1	22 15 40 2	22 15 40 3	22 15 40 4
	6	22 15 60 1	22 15 60 2	22 15 60 3	22 15 60 4
	1/4"	22 15 61 1	22 15 61 2	22 15 61 3	22 15 61 4
mat finish	3	28 15 30 1	28 15 30 2	28 15 30 3	28 15 30 4
	1/8"	28 15 31 1	28 15 31 2	28 15 31 3	28 15 31 4
	4	28 15 40 1	28 15 40 2	28 15 40 3	28 15 40 4
	6	28 15 60 1	28 15 60 2	28 15 60 3	28 15 60 4
	1/4"	28 15 61 1	28 15 61 2	28 15 61 3	28 15 61 4

standard	23 15 30 1	23 15 30 2	23 15 30 3	23 15 30 4
	23 15 31 1	23 15 31 2	23 15 31 3	23 15 31 4
	23 15 40 1	23 15 40 2	23 15 40 3	23 15 40 4
	23 15 60 1	23 15 60 2	23 15 60 3	23 15 60 4
	23 15 61 1	23 15 61 2	23 15 61 3	23 15 61 4
mat finish	29 15 30 1	29 15 30 2	29 15 30 3	29 15 30 4
	29 15 31 1	29 15 31 2	29 15 31 3	29 15 31 4
	29 15 40 1	29 15 40 2	29 15 40 3	29 15 40 4
	29 15 60 1	29 15 60 2	29 15 60 3	29 15 60 4
	29 15 61 1	29 15 61 2	29 15 61 3	29 15 61 4

Pfeilknopf Bouton à flèche Arrow knob

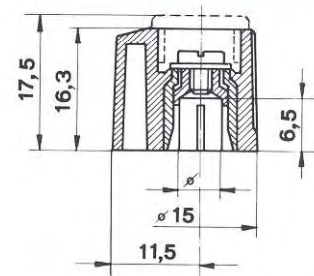

mit Strich – avec repère – with line

	φ				
standard	3	18 15 30 1	18 15 30 2	18 15 30 3	18 15 30 4
	1/8"	18 15 31 1	18 15 31 2	18 15 31 3	18 15 31 4
	4	18 15 40 1	18 15 40 2	18 15 40 3	18 15 40 4
	6	18 15 60 1	18 15 60 2	18 15 60 3	18 15 60 4
	1/4"	18 15 61 1	18 15 61 2	18 15 61 3	18 15 61 4
mat finish	3	16 15 30 1	16 15 30 2	16 15 30 3	16 15 30 4
	1/8"	16 15 31 1	16 15 31 2	16 15 31 3	16 15 31 4
	4	16 15 40 1	16 15 40 2	16 15 40 3	16 15 40 4
	6	16 15 60 1	16 15 60 2	16 15 60 3	16 15 60 4
	1/4"	16 15 61 1	16 15 61 2	16 15 61 3	16 15 61 4

standard	19 15 30 1	19 15 30 2	19 15 30 3	19 15 30 4
	19 15 31 1	19 15 31 2	19 15 31 3	19 15 31 4
	19 15 40 1	19 15 40 2	19 15 40 3	19 15 40 4
	19 15 60 1	19 15 60 2	19 15 60 3	19 15 60 4
	19 15 61 1	19 15 61 2	19 15 61 3	19 15 61 4
mat finish	17 15 30 1	17 15 30 2	17 15 30 3	17 15 30 4
	17 15 31 1	17 15 31 2	17 15 31 3	17 15 31 4
	17 15 40 1	17 15 40 2	17 15 40 3	17 15 40 4
	17 15 60 1	17 15 60 2	17 15 60 3	17 15 60 4
	17 15 61 1	17 15 61 2	17 15 61 3	17 15 61 4

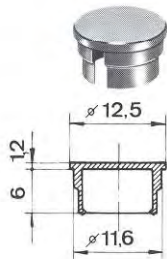

mit Strich
avec trait
with line

mit Schwellpfeil
avec flèche coudée
with curved arrow

mit Pfeil
avec flèche
with arrow

Deckel flach — Capuchon plat — Flat cap

standard	30 15 00 1	30 15 00 2	30 15 00 3	30 15 00 4	30 15 00 5	30 15 00 6	30 15 00 7
mat finish	30 15 10 1	30 15 10 2	30 15 10 3	30 15 10 4	30 15 10 5	30 15 10 6	30 15 10 7

standard	30 15 01 1	30 15 01 2	30 15 01 3	30 15 01 4	30 15 01 5	30 15 01 6	30 15 01 7
mat finish	30 15 11 1	30 15 11 2	30 15 11 3	30 15 11 4	30 15 11 5	30 15 11 6	30 15 11 7

standard	30 15 02 1	30 15 02 2	30 15 02 3	30 15 02 4	30 15 02 5	30 15 02 6	30 15 02 7
mat finish	30 15 12 1	30 15 12 2	30 15 12 3	30 15 12 4	30 15 12 5	30 15 12 6	30 15 12 7

standard	30 15 03 1	30 15 03 2	30 15 03 3	30 15 03 4	30 15 03 5	30 15 03 6	30 15 03 7
mat finish	30 15 13 1	30 15 13 2	30 15 13 3	30 15 13 4	30 15 13 5	30 15 13 6	30 15 13 7

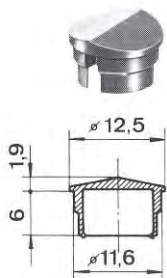

mit Punkt
avec point
with point

Deckel prismaform — Capuchon prismatique — Prismatic cap

standard	31 15 00 1	31 15 00 2	31 15 00 3	31 15 00 4	31 15 00 5	31 15 00 6	31 15 00 7
mat finish	31 15 10 1	31 15 10 2	31 15 10 3	31 15 10 4	31 15 10 5	31 15 10 6	31 15 10 7

standard	31 15 04 1	31 15 04 2	31 15 04 3	31 15 04 4	31 15 04 5	31 15 04 6	31 15 04 7
mat finish	31 15 14 1	31 15 14 2	31 15 14 3	31 15 14 4	31 15 14 5	31 15 14 6	31 15 14 7



mit Strich
avec trait
with line

Deckel bombiert — Capuchon courbé — Curved cap

standard	32 15 00 1	32 15 00 2	32 15 00 3	32 15 00 4	32 15 00 5	32 15 00 6	32 15 00 7
mat finish	32 15 10 1	32 15 10 2	32 15 10 3	32 15 10 4	32 15 10 5	32 15 10 6	32 15 10 7

standard	32 15 01 1	32 15 01 2	32 15 01 3	32 15 01 4	32 15 01 5	32 15 01 6	32 15 01 7
mat finish	32 15 11 1	32 15 11 2	32 15 11 3	32 15 11 4	32 15 11 5	32 15 11 6	32 15 11 7

Deckel flach — Capuchon plat — Flat cap

mit Aluminium-Scheibe
avec disque aluminium
with aluminium disk

standard	35 15 00 1	35 15 00 2	35 15 00 3	35 15 00 4
mat finish	35 15 10 1	35 15 10 2	35 15 10 3	35 15 10 4

mit Alu-Scheibe und Strich
avec disque alu et repère
with alu disk and line

standard	35 15 01 1	35 15 01 2	35 15 01 3	35 15 01 4
mat finish	35 15 11 1	35 15 11 2	35 15 11 3	35 15 11 4

Knopf Bouton Knob



	φ				
standard	3	20 21 30 1	20 21 30 2	20 21 30 3	20 21 30 4
	1/8"	20 21 31 1	20 21 31 2	20 21 31 3	20 21 31 4
	4	20 21 40 1	20 21 40 2	20 21 40 3	20 21 40 4
	6	20 21 60 1	20 21 60 2	20 21 60 3	20 21 60 4
	1/4"	20 21 61 1	20 21 61 2	20 21 61 3	20 21 61 4
mat finish	3	26 21 30 1	26 21 30 2	26 21 30 3	26 21 30 4
	1/8"	26 21 31 1	26 21 31 2	26 21 31 3	26 21 31 4
	4	26 21 40 1	26 21 40 2	26 21 40 3	26 21 40 4
	6	26 21 60 1	26 21 60 2	26 21 60 3	26 21 60 4
	1/4"	26 21 61 1	26 21 61 2	26 21 61 3	26 21 61 4

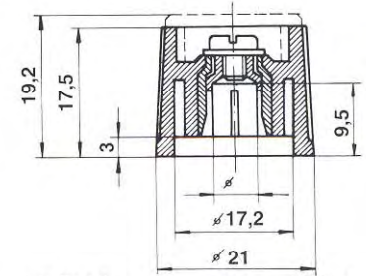

mit Strich – avec repère – with line

21 21 30 1	21 21 30 2	21 21 30 3	21 21 30 4	
21 21 31 1	21 21 31 2	21 21 31 3	21 21 31 4	
21 21 40 1	21 21 40 2	21 21 40 3	21 21 40 4	
21 21 60 1	21 21 60 2	21 21 60 3	21 21 60 4	
21 21 61 1	21 21 61 2	21 21 61 3	21 21 61 4	
27 21 30 1	27 21 30 2	27 21 30 3	27 21 30 4	
27 21 31 1	27 21 31 2	27 21 31 3	27 21 31 4	
27 21 40 1	27 21 40 2	27 21 40 3	27 21 40 4	
27 21 60 1	27 21 60 2	27 21 60 3	27 21 60 4	
27 21 61 1	27 21 61 2	27 21 61 3	27 21 61 4	

Knebelknopf Bouton à oreilles Wing knob



	φ				
standard	3	22 21 30 1	22 21 30 2	22 21 30 3	22 21 30 4
	1/8"	22 21 31 1	22 21 31 2	22 21 31 3	22 21 31 4
	4	22 21 40 1	22 21 40 2	22 21 40 3	22 21 40 4
	6	22 21 60 1	22 21 60 2	22 21 60 3	22 21 60 4
	1/4"	22 21 61 1	22 21 61 2	22 21 61 3	22 21 61 4
mat finish	3	28 21 30 1	28 21 30 2	28 21 30 3	28 21 30 4
	1/8"	28 21 31 1	28 21 31 2	28 21 31 3	28 21 31 4
	4	28 21 40 1	28 21 40 2	28 21 40 3	28 21 40 4
	6	28 21 60 1	28 21 60 2	28 21 60 3	28 21 60 4
	1/4"	28 21 61 1	28 21 61 2	28 21 61 3	28 21 61 4

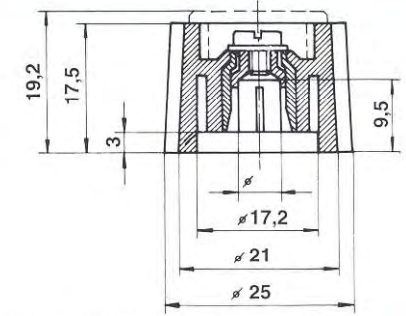

mit Strich – avec repère – with line

23 21 30 1	23 21 30 2	23 21 30 3	23 21 30 4	
23 21 31 1	23 21 31 2	23 21 31 3	23 21 31 4	
23 21 40 1	23 21 40 2	23 21 40 3	23 21 40 4	
23 21 60 1	23 21 60 2	23 21 60 3	23 21 60 4	
23 21 61 1	23 21 61 2	23 21 61 3	23 21 61 4	
29 21 30 1	29 21 30 2	29 21 30 3	29 21 30 4	
29 21 31 1	29 21 31 2	29 21 31 3	29 21 31 4	
29 21 40 1	29 21 40 2	29 21 40 3	29 21 40 4	
29 21 60 1	29 21 60 2	29 21 60 3	29 21 60 4	
29 21 61 1	29 21 61 2	29 21 61 3	29 21 61 4	

Pfeilknopf Bouton à flèche Arrow knob



	φ				
standard	3	18 21 30 1	18 21 30 2	18 21 30 3	18 21 30 4
	1/8"	18 21 31 1	18 21 31 2	18 21 31 3	18 21 31 4
	4	18 21 40 1	18 21 40 2	18 21 40 3	18 21 40 4
	6	18 21 60 1	18 21 60 2	18 21 60 3	18 21 60 4
	1/4"	18 21 61 1	18 21 61 2	18 21 61 3	18 21 61 4
mat finish	3	16 21 30 1	16 21 30 2	16 21 30 3	16 21 30 4
	1/8"	16 21 31 1	16 21 31 2	16 21 31 3	16 21 31 4
	4	16 21 40 1	16 21 40 2	16 21 40 3	16 21 40 4
	6	16 21 60 1	16 21 60 2	16 21 60 3	16 21 60 4
	1/4"	16 21 61 1	16 21 61 2	16 21 61 3	16 21 61 4

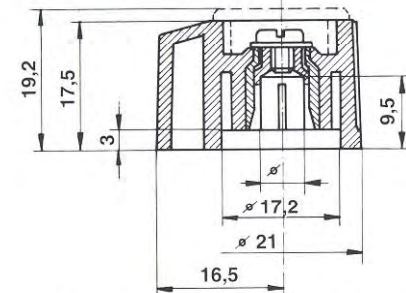

mit Strich – avec repère – with line

19 21 30 1	19 21 30 2	19 21 30 3	19 21 30 4	
19 21 31 1	19 21 31 2	19 21 31 3	19 21 31 4	
19 21 40 1	19 21 40 2	19 21 40 3	19 21 40 4	
19 21 60 1	19 21 60 2	19 21 60 3	19 21 60 4	
19 21 61 1	19 21 61 2	19 21 61 3	19 21 61 4	
17 21 30 1	17 21 30 2	17 21 30 3	17 21 30 4	
17 21 31 1	17 21 31 2	17 21 31 3	17 21 31 4	
17 21 40 1	17 21 40 2	17 21 40 3	17 21 40 4	
17 21 60 1	17 21 60 2	17 21 60 3	17 21 60 4	
17 21 61 1	17 21 61 2	17 21 61 3	17 21 61 4	

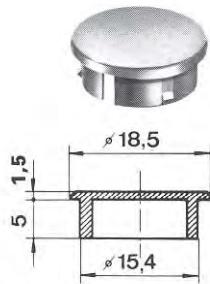

mit Strich
avec trait
with line

mit Schwellpfeil
avec flèche coudée
with curved arrow

mit Pfeil
avec flèche
with arrow

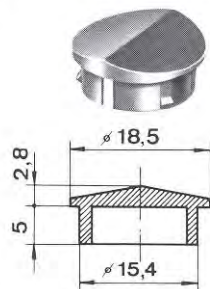

mit Punkt
avec point
with point

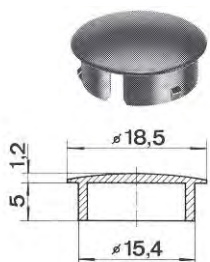

mit Strich
avec trait
with line

mit Aluminium-Scheibe
avec disque aluminium
with aluminium disk

mit Alu-Scheibe und Strich
avec disque alu et repère
with alu disk and line

Deckel flach — Capuchon plat — Flat cap

standard	30 21 00 1	30 21 00 2	30 21 00 3	30 21 00 4	30 21 00 5	30 21 00 6	30 21 00 7
mat finish	30 21 10 1	30 21 10 2	30 21 10 3	30 21 10 4	30 21 10 5	30 21 10 6	30 21 10 7
standard	30 21 01 1	30 21 01 2	30 21 01 3	30 21 01 4	30 21 01 5	30 21 01 6	30 21 01 7
mat finish	30 21 11 1	30 21 11 2	30 21 11 3	30 21 11 4	30 21 11 5	30 21 11 6	30 21 11 7
standard	30 21 02 1	30 21 02 2	30 21 02 3	30 21 02 4	30 21 02 5	30 21 02 6	30 21 02 7
mat finish	30 21 12 1	30 21 12 2	30 21 12 3	30 21 12 4	30 21 12 5	30 21 12 6	30 21 12 7
standard	30 21 03 1	30 21 03 2	30 21 03 3	30 21 03 4	30 21 03 5	30 21 03 6	30 21 03 7
mat finish	30 21 13 1	30 21 13 2	30 21 13 3	30 21 13 4	30 21 13 5	30 21 13 6	30 21 13 7

Deckel prismaform — Capuchon prismatique — Prismatic cap

standard	31 21 00 1	31 21 00 2	31 21 00 3	31 21 00 4	31 21 00 5	31 21 00 6	31 21 00 7
mat finish	31 21 10 1	31 21 10 2	31 21 10 3	31 21 10 4	31 21 10 5	31 21 10 6	31 21 10 7
standard	31 21 04 1	31 21 04 2	31 21 04 3	31 21 04 4	31 21 04 5	31 21 04 6	31 21 04 7
mat finish	31 21 14 1	31 21 14 2	31 21 14 3	31 21 14 4	31 21 14 5	31 21 14 6	31 21 14 7

Deckel bombiert — Capuchon courbé — Curved cap

standard	32 21 00 1	32 21 00 2	32 21 00 3	32 21 00 4	32 21 00 5	32 21 00 6	32 21 00 7
mat finish	32 21 10 1	32 21 10 2	32 21 10 3	32 21 10 4	32 21 10 5	32 21 10 6	32 21 10 7
standard	32 21 01 1	32 21 01 2	32 21 01 3	32 21 01 4	32 21 01 5	32 21 01 6	32 21 01 7
mat finish	32 21 11 1	32 21 11 2	32 21 11 3	32 21 11 4	32 21 11 5	32 21 11 6	32 21 11 7

Deckel flach — Capuchon plat — Flat cap

standard	35 21 00 1	35 21 00 2	35 21 00 3	35 21 00 4
mat finish	35 21 10 1	35 21 10 2	35 21 10 3	35 21 10 4
standard	35 21 01 1	35 21 01 2	35 21 01 3	35 21 01 4
mat finish	35 21 11 1	35 21 11 2	35 21 11 3	35 21 11 4

Knopf Bouton Knob

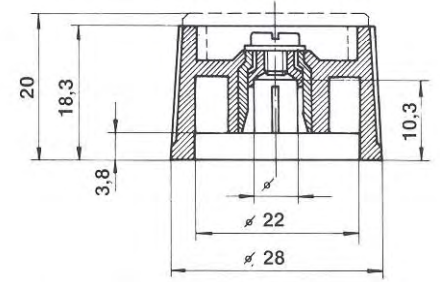

	ϕ				
standard	4	20 28 40 1	20 28 40 2	20 28 40 3	20 28 40 4
	6	20 28 60 1	20 28 60 2	20 28 60 3	20 28 60 4
	1/4"	20 28 61 1	20 28 61 2	20 28 61 3	20 28 61 4
mat finish	4	26 28 40 1	26 28 40 2	26 28 40 3	26 28 40 4
	6	26 28 60 1	26 28 60 2	26 28 60 3	26 28 60 4
	1/4"	26 28 61 1	26 28 61 2	26 28 61 3	26 28 61 4

mit Strich — avec repère — with line

	ϕ				
standard	4	21 28 40 1	21 28 40 2	21 28 40 3	21 28 40 4
	6	21 28 60 1	21 28 60 2	21 28 60 3	21 28 60 4
	1/4"	21 28 61 1	21 28 61 2	21 28 61 3	21 28 61 4
mat finish	4	27 28 40 1	27 28 40 2	27 28 40 3	27 28 40 4
	6	27 28 60 1	27 28 60 2	27 28 60 3	27 28 60 4
	1/4"	27 28 61 1	27 28 61 2	27 28 61 3	27 28 61 4

Knebelknopf Bouton à oreilles Wing knob

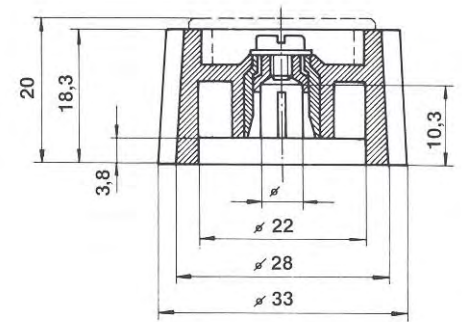

	ϕ				
standard	4	22 28 40 1	22 28 40 2	22 28 40 3	22 28 40 4
	6	22 28 60 1	22 28 60 2	22 28 60 3	22 28 60 4
	1/4"	22 28 61 1	22 28 61 2	22 28 61 3	22 28 61 4
mat finish	4	28 28 40 1	28 28 40 2	28 28 40 3	28 28 40 4
	6	28 28 60 1	28 28 60 2	28 28 60 3	28 28 60 4
	1/4"	28 28 61 1	28 28 61 2	28 28 61 3	28 28 61 4

mit Strich — avec repère — with line

	ϕ				
standard	4	23 28 40 1	23 28 40 2	23 28 40 3	23 28 40 4
	6	23 28 60 1	23 28 60 2	23 28 60 3	23 28 60 4
	1/4"	23 28 61 1	23 28 61 2	23 28 61 3	23 28 61 4
mat finish	4	29 28 40 1	29 28 40 2	29 28 40 3	29 28 40 4
	6	29 28 60 1	29 28 60 2	29 28 60 3	29 28 60 4
	1/4"	29 28 61 1	29 28 61 2	29 28 61 3	29 28 61 4

Pfeilknopf Bouton à flèche Arrow knob

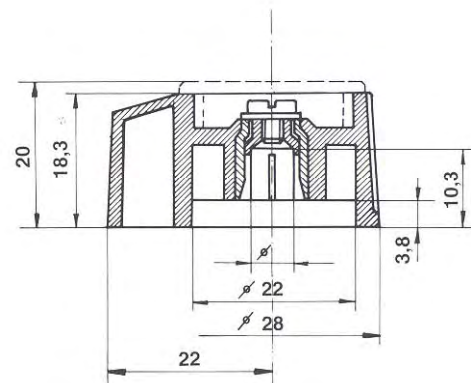

	ϕ				
standard	6	18 28 60 1	18 28 60 2	18 28 60 3	18 28 60 4
	1/4"	18 28 61 1	18 28 61 2	18 28 61 3	18 28 61 4
	mat finish	6	16 28 60 1	16 28 60 2	16 28 60 3
	1/4"	16 28 61 1	16 28 61 2	16 28 61 3	16 28 61 4

mit Strich — avec repère — with line

	ϕ				
standard	6	19 28 60 1	19 28 60 2	19 28 60 3	19 28 60 4
	1/4"	19 28 61 1	19 28 61 2	19 28 61 3	19 28 61 4
	mat finish	6	17 28 60 1	17 28 60 2	17 28 60 3
	1/4"	17 28 61 1	17 28 61 2	17 28 61 3	17 28 61 4

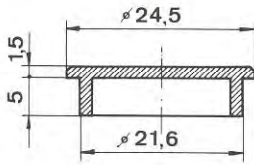

mit Strich
avec trait
with line

mit Schwellpfeil
avec flèche coudée
with curved arrow

mit Pfeil
avec flèche
with arrow

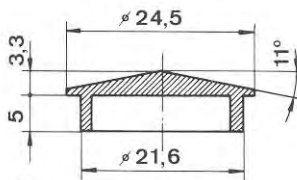

mit Punkt
avec point
with point

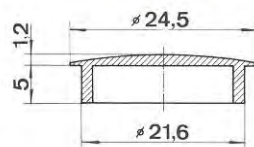

mit Strich
avec trait
with line

mit Aluminium-Scheibe
avec disque aluminium
with aluminium disk

mit Alu-Scheibe und Strich
avec disque alu et repère
with alu disk and line

Deckel flach — Capuchon plat — Flat cap

standard mat finish	30 28 00 1 30 28 10 1	30 28 00 2 30 28 10 2	30 28 00 3 30 28 10 3	30 28 00 4 30 28 10 4	30 28 00 5 30 28 10 5	30 28 00 6 30 28 10 6	30 28 00 7 30 28 10 7
standard mat finish	30 28 01 1 30 28 11 1	30 28 01 2 30 28 11 2	30 28 01 3 30 28 11 3	30 28 01 4 30 28 11 4	30 28 01 5 30 28 11 5	30 28 01 6 30 28 11 6	30 28 01 7 30 28 11 7
standard mat finish	30 28 02 1 30 28 12 1	30 28 02 2 30 28 12 2	30 28 02 3 30 28 12 3	30 28 02 4 30 28 12 4	30 28 02 5 30 28 12 5	30 28 02 6 30 28 12 6	30 28 02 7 30 28 12 7
standard mat finish	30 28 03 1 30 28 13 1	30 28 03 2 30 28 13 2	30 28 03 3 30 28 13 3	30 28 03 4 30 28 13 4	30 28 03 5 30 28 13 5	30 28 03 6 30 28 13 6	30 28 03 7 30 28 13 7

Deckel prismaform — Capuchon prismatique — Prismatic cap

standard mat finish	31 28 00 1 31 28 10 1	31 28 00 2 31 28 10 2	31 28 00 3 31 28 10 3	31 28 00 4 31 28 10 4	31 28 00 5 31 28 10 5	31 28 00 6 31 28 10 6	31 28 00 7 31 28 10 7
standard mat finish	31 28 04 1 31 28 14 1	31 28 04 2 31 28 14 2	31 28 04 3 31 28 14 3	31 28 04 4 31 28 14 4	31 28 04 5 31 28 14 5	31 28 04 6 31 28 14 6	31 28 04 7 31 28 14 7

Deckel bombiert — Capuchon courbé — Curved cap

standard mat finish	32 28 00 1 32 28 10 1	32 28 00 2 32 28 10 2	32 28 00 3 32 28 10 3	32 28 00 4 32 28 10 4	32 28 00 5 32 28 10 5	32 28 00 6 32 28 10 6	32 28 00 7 32 28 10 7
standard mat finish	32 28 01 1 32 28 11 1	32 28 01 2 32 28 11 2	32 28 01 3 32 28 11 3	32 28 01 4 32 28 11 4	32 28 01 5 32 28 11 5	32 28 01 6 32 28 11 6	32 28 01 7 32 28 11 7

Deckel flach — Capuchon plat — Flat cap

standard mat finish	35 28 00 1 35 28 10 1	35 28 00 2 35 28 10 2	35 28 00 3 35 28 10 3	35 28 00 4 35 28 10 4
standard mat finish	35 28 01 1 35 28 11 1	35 28 01 2 35 28 11 2	35 28 01 3 35 28 11 3	35 28 01 4 35 28 11 4

Knopf
Bouton
Knob

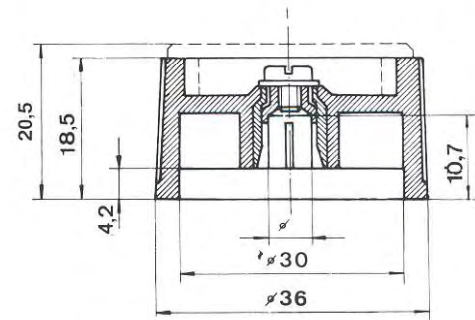

mit Strich — avec repère — with line

	φ	
standard	6 1/4"	
mat finish	6 1/4"	



20 36 60 1	20 36 60 2	20 36 60 3	20 36 60 4
20 36 61 1	20 36 61 2	20 36 61 3	20 36 61 4
26 36 60 1	26 36 60 2	26 36 60 3	26 36 60 4
26 36 61 1	26 36 61 2	26 36 61 3	26 36 61 4



21 36 60 1	21 36 60 2	21 36 60 3	21 36 60 4
21 36 61 1	21 36 61 2	21 36 61 3	21 36 61 4
27 36 60 1	27 36 60 2	27 36 60 3	27 36 60 4
27 36 61 1	27 36 61 2	27 36 61 3	27 36 61 4

Knebelknopf
Bouton à oreilles
Wing knob

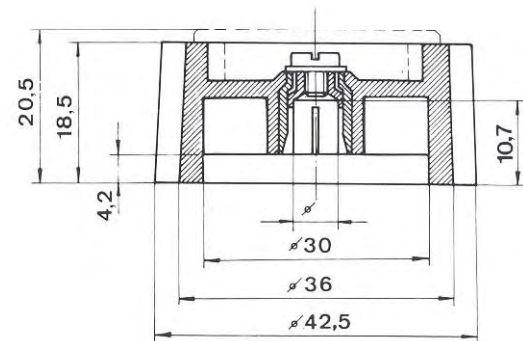

mit Strich — avec repère — with line

	φ	
standard	6 1/4"	
mat finish	6 1/4"	



22 36 60 1	22 36 60 2	22 36 60 3	22 36 60 4
22 36 61 1	22 36 61 2	22 36 61 3	22 36 61 4
28 36 60 1	28 36 60 2	28 36 60 3	28 36 60 4
28 36 61 1	28 36 61 2	28 36 61 3	28 36 61 4



23 36 60 1	23 36 60 2	23 36 60 3	23 36 60 4
23 36 61 1	23 36 61 2	23 36 61 3	23 36 61 4
29 36 60 1	29 36 60 2	29 36 60 3	29 36 60 4
29 36 61 1	29 36 61 2	29 36 61 3	29 36 61 4

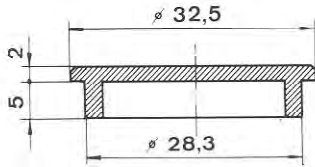

mit Strich
avec trait
with line

mit Schwellpfeil
avec flèche coudée
with curved arrow

mit Pfeil
avec flèche
with arrow

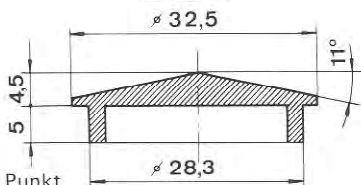

mit Punkt
avec point
with point

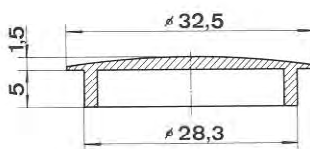

mit Strich
avec trait
with line

mit Aluminium-Scheibe
avec disque aluminium
with aluminium disk

mit Alu-Scheibe und Strich
avec disque alu et repère
with alu disk and line

Deckel flach — Capuchon plat — Flat cap

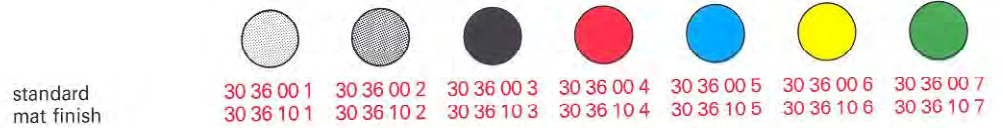

Deckel prismaform — Capuchon prismatique — Prismatic cap

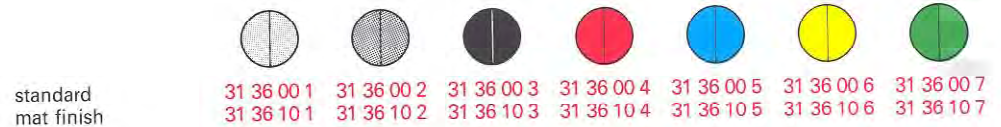

Deckel bombiert — Capuchon courbé — Curved cap

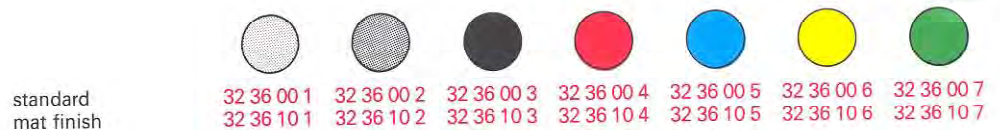

Deckel flach — Capuchon plat — Flat cap



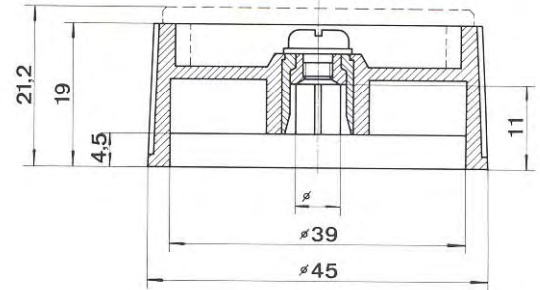
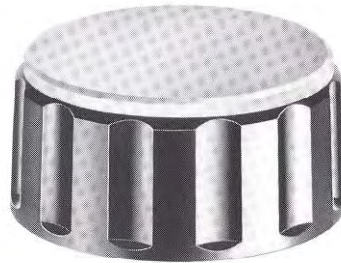

Knopf
Bouton
Knob

mit Strich – avec repère – with line

	Ø								
standard	6	20 45 60 1	20 45 60 2	20 45 60 3	20 45 60 4	21 45 60 1	21 45 60 2	21 45 60 3	21 45 60 4
	¼"	20 45 61 1	20 45 61 2	20 45 61 3	20 45 61 4	21 45 61 1	21 45 61 2	21 45 61 3	21 45 61 4
mat finish	6	26 45 60 1	26 45 60 2	26 45 60 3	26 45 60 4	27 45 60 1	27 45 60 2	27 45 60 3	27 45 60 4
	¼"	26 45 61 1	26 45 61 2	26 45 61 3	26 45 61 4	27 45 61 1	27 45 61 2	27 45 61 3	27 45 61 4

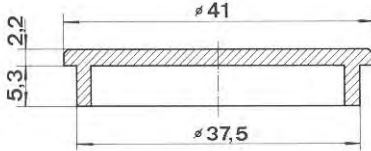

mit Strich
avec trait
with line

mit Schwellpfeil
avec flèche coudée
with curved arrow

mit Pfeil
avec flèche
with arrow

Deckel flach — Capuchon plat — Flat cap

standard
mat finish



standard
mat finish



standard
mat finish



standard
mat finish

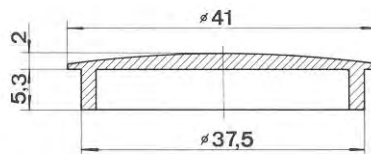

mit Strich
avec trait
with line

Deckel bombiert — Capuchon courbé — Curved cap

standard
mat finish



standard
mat finish



15 mm

Kurzknopf Bouton court Short knob



	Ø								
standard	3	60 15 30 1	60 15 30 2	60 15 30 3	60 15 30 4	61 15 30 1	61 15 30 2	61 15 30 3	61 15 30 4
	1/8"	60 15 31 1	60 15 31 2	60 15 31 3	60 15 31 4	61 15 31 1	61 15 31 2	61 15 31 3	61 15 31 4
	4	60 15 40 1	60 15 40 2	60 15 40 3	60 15 40 4	61 15 40 1	61 15 40 2	61 15 40 3	61 15 40 4
	6	60 15 60 1	60 15 60 2	60 15 60 3	60 15 60 4	61 15 60 1	61 15 60 2	61 15 60 3	61 15 60 4
mat finish	1/4"	60 15 61 1	60 15 61 2	60 15 61 3	60 15 61 4	61 15 61 1	61 15 61 2	61 15 61 3	61 15 61 4
	3	66 15 30 1	66 15 30 2	66 15 30 3	66 15 30 4	67 15 30 1	67 15 30 2	67 15 30 3	67 15 30 4
	1/8"	66 15 31 1	66 15 31 2	66 15 31 3	66 15 31 4	67 15 31 1	67 15 31 2	67 15 31 3	67 15 31 4
	4	66 15 40 1	66 15 40 2	66 15 40 3	66 15 40 4	67 15 40 1	67 15 40 2	67 15 40 3	67 15 40 4
1/4"	6	66 15 60 1	66 15 60 2	66 15 60 3	66 15 60 4	67 15 60 1	67 15 60 2	67 15 60 3	67 15 60 4
	1/4"	66 15 61 1	66 15 61 2	66 15 61 3	66 15 61 4	67 15 61 1	67 15 61 2	67 15 61 3	67 15 61 4

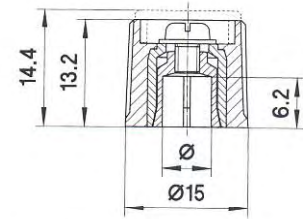

mit Strich – avec repère – with line

Kurzknobelknopf Bouton court à oreilles Short wing knob



	Ø								
standard	3	62 15 30 1	62 15 30 2	62 15 30 3	62 15 30 4	63 15 30 1	63 15 30 2	63 15 30 3	63 15 30 4
	1/8"	62 15 31 1	62 15 31 2	62 15 31 3	62 15 31 4	63 15 31 1	63 15 31 2	63 15 31 3	63 15 31 4
	4	62 15 40 1	62 15 40 2	62 15 40 3	62 15 40 4	63 15 40 1	63 15 40 2	63 15 40 3	63 15 40 4
	6	62 15 60 1	62 15 60 2	62 15 60 3	62 15 60 4	63 15 60 1	63 15 60 2	63 15 60 3	63 15 60 4
mat finish	1/4"	62 15 61 1	62 15 61 2	62 15 61 3	62 15 61 4	63 15 61 1	63 15 61 2	63 15 61 3	63 15 61 4
	3	68 15 30 1	68 15 30 2	68 15 30 3	68 15 30 4	69 15 30 1	69 15 30 2	69 15 30 3	69 15 30 4
	1/8"	68 15 31 1	68 15 31 2	68 15 31 3	68 15 31 4	69 15 31 1	69 15 31 2	69 15 31 3	69 15 31 4
	4	68 15 40 1	68 15 40 2	68 15 40 3	68 15 40 4	69 15 40 1	69 15 40 2	69 15 40 3	69 15 40 4
1/4"	6	68 15 60 1	68 15 60 2	68 15 60 3	68 15 60 4	69 15 60 1	69 15 60 2	69 15 60 3	69 15 60 4
	1/4"	68 15 61 1	68 15 61 2	68 15 61 3	68 15 61 4	69 15 61 1	69 15 61 2	69 15 61 3	69 15 61 4

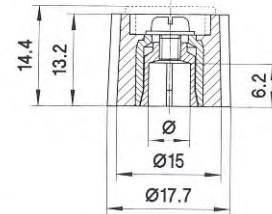

mit Strich – avec repère – with line

Zubehör Accessoires Accessories

Für diesen Kurzknopf können alle Zubehörteile verwendet werden.

Achtung: Bei den Deckeln muss zur normalen Bestell-Nummer auf Seite 13 der Zusatz «BV 204» beigefügt werden.

Tous les accessoires sont applicables pour ce bouton.

Attention: Pour les commandes des capuchons il faut ajouter au numéro normal de la commande à la page 13 le supplément «BV 204».

All accessories are usable for this knob.

Attention: For cap orders please add on the normal number on page 13 the addition «BV 204».

15 mm

Kurzknopf
Bouton court
Short knob

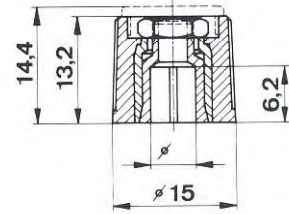

standard

mat finish

	Ø								
standard	3	60 15 36 1	60 15 36 2	60 15 36 3	60 15 36 4	6115 36 1	6115 36 2	6115 36 3	6115 36 4
	1/8"	60 15 37 1	60 15 37 2	60 15 37 3	60 15 37 4	6115 37 1	6115 37 2	6115 37 3	6115 37 4
	4	60 15 46 1	60 15 46 2	60 15 46 3	60 15 46 4	6115 46 1	6115 46 2	6115 46 3	6115 46 4
	6	60 15 70 1	60 15 70 2	60 15 70 3	60 15 70 4	6115 70 1	6115 70 2	6115 70 3	6115 70 4
mat finish	1/4"	60 15 71 1	60 15 71 2	60 15 71 3	60 15 71 4	6115 71 1	6115 71 2	6115 71 3	6115 71 4
	3	66 15 36 1	66 15 36 2	66 15 36 3	66 15 36 4	67 15 36 1	67 15 36 2	67 15 36 3	67 15 36 4
	1/8"	66 15 37 1	66 15 37 2	66 15 37 3	66 15 37 4	67 15 37 1	67 15 37 2	67 15 37 3	67 15 37 4
	4	66 15 46 1	66 15 46 2	66 15 46 3	66 15 46 4	67 15 46 1	67 15 46 2	67 15 46 3	67 15 46 4
mat finish	6	66 15 70 1	66 15 70 2	66 15 70 3	66 15 70 4	67 15 70 1	67 15 70 2	67 15 70 3	67 15 70 4
	1/4"	66 15 71 1	66 15 71 2	66 15 71 3	66 15 71 4	67 15 71 1	67 15 71 2	67 15 71 3	67 15 71 4

mit Strich – avec repère – with line

Kurzkebelknopf
Bouton court à oreilles
Short wing knob

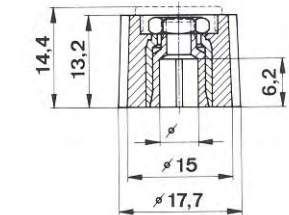

standard

mat finish

	Ø								
standard	3	62 15 36 1	62 15 36 2	62 15 36 3	62 15 36 4	63 15 36 1	63 15 36 2	63 15 36 3	63 15 36 4
	1/8"	62 15 37 1	62 15 37 2	62 15 37 3	62 15 37 4	63 15 37 1	63 15 37 2	63 15 37 3	63 15 37 4
	4	62 15 46 1	62 15 46 2	62 15 46 3	62 15 46 4	63 15 46 1	63 15 46 2	63 15 46 3	63 15 46 4
	6	62 15 70 1	62 15 70 2	62 15 70 3	62 15 70 4	63 15 70 1	63 15 70 2	63 15 70 3	63 15 70 4
mat finish	1/4"	62 15 71 1	62 15 71 2	62 15 71 3	62 15 71 4	63 15 71 1	63 15 71 2	63 15 71 3	63 15 71 4
	3	68 15 36 1	68 15 36 2	68 15 36 3	68 15 36 4	69 15 36 1	69 15 36 2	69 15 36 3	69 15 36 4
	1/8"	68 15 37 1	68 15 37 2	68 15 37 3	68 15 37 4	69 15 37 1	69 15 37 2	69 15 37 3	69 15 37 4
	4	68 15 46 1	68 15 46 2	68 15 46 3	68 15 46 4	69 15 46 1	69 15 46 2	69 15 46 3	69 15 46 4
mat finish	6	68 15 70 1	68 15 70 2	68 15 70 3	68 15 70 4	69 15 70 1	69 15 70 2	69 15 70 3	69 15 70 4
	1/4"	68 15 71 1	68 15 71 2	68 15 71 3	68 15 71 4	69 15 71 1	69 15 71 2	69 15 71 3	69 15 71 4

mit Strich – avec repère – with line

Zubehör
Accessoires
Accessories

Für diesen Kurzknopf können alle Zubehörteile verwendet werden.

Achtung: Bei den Deckeln muss zur normalen Bestell-Nummer auf Seite 13 der Zusatz «BV 204» beigefügt werden.

Tous les accessoires sont applicables pour ce bouton.

Attention: Pour les commandes des capuchons il faut ajouter au numéro normal de la commande à la page 13 le supplément «BV 204».

All accessories are usable for this knob.

Attention: For cap orders please add on the normal number on page 13 the addition «BV 204».

21 mm

Kurzknopf
Bouton court
Short knob



	Ø				
standard	3	60 21 36 1	60 21 36 2	60 21 36 3	60 21 36 4
	1/8"	60 21 37 1	60 21 37 2	60 21 37 3	60 21 37 4
	4	60 21 46 1	60 21 46 2	60 21 46 3	60 21 46 4
	6	60 21 76 1	60 21 76 2	60 21 76 3	60 21 76 4
mat finish	1/4"	60 21 75 1	60 21 75 2	60 21 75 3	60 21 75 4
	3	66 21 36 1	66 21 36 2	66 21 36 3	66 21 36 4
	1/8"	66 21 37 1	66 21 37 2	66 21 37 3	66 21 37 4
	4	66 21 46 1	66 21 46 2	66 21 46 3	66 21 46 4
6	66 21 76 1	66 21 76 2	66 21 76 3	66 21 76 4	
	1/4"	66 21 75 1	66 21 75 2	66 21 75 3	66 21 75 4

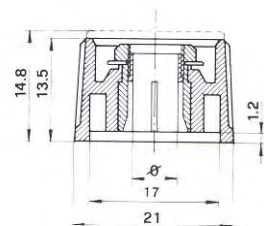

mit Strich — avec repère — with line

61 21 36 1	61 21 36 2	61 21 36 3	61 21 36 4	
61 21 37 1	61 21 37 2	61 21 37 3	61 21 37 4	
61 21 46 1	61 21 46 2	61 21 46 3	61 21 46 4	
61 21 76 1	61 21 76 2	61 21 76 3	61 21 76 4	
61 21 75 1	61 21 75 2	61 21 75 3	61 21 75 4	
67 21 36 1	67 21 36 2	67 21 36 3	67 21 36 4	
67 21 37 1	67 21 37 2	67 21 37 3	67 21 37 4	
67 21 46 1	67 21 46 2	67 21 46 3	67 21 46 4	
67 21 76 1	67 21 76 2	67 21 76 3	67 21 76 4	
67 21 75 1	67 21 75 2	67 21 75 3	67 21 75 4	

28 mm

Kurzknopf
Bouton court
Short knob



	Ø				
standard	4	60 28 46 1	60 28 46 2	60 28 46 3	60 28 46 4
	6	60 28 76 1	60 28 76 2	60 28 76 3	60 28 76 4
	1/4"	60 28 75 1	60 28 75 2	60 28 75 3	60 28 75 4
mat finish	4	66 28 46 1	66 28 46 2	66 28 46 3	66 28 46 4
	6	66 28 76 1	66 28 76 2	66 28 76 3	66 28 76 4
	1/4"	66 28 75 1	66 28 75 2	66 28 75 3	66 28 75 4

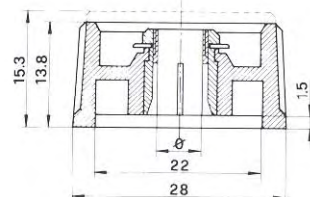

mit Strich — avec repère — with line

61 28 46 1	61 28 46 2	61 28 46 3	61 28 46 4	
61 28 76 1	61 28 76 2	61 28 76 3	61 28 76 4	
61 28 75 1	61 28 75 2	61 28 75 3	61 28 75 4	
67 28 46 1	67 28 46 2	67 28 46 3	67 28 46 4	
67 28 76 1	67 28 76 2	67 28 76 3	67 28 76 4	
67 28 75 1	67 28 75 2	67 28 75 3	67 28 75 4	

36 mm

Kurzknopf
Bouton court
Short knob



	Ø				
standard	6	60 36 76 1	60 36 76 2	60 36 76 3	60 36 76 4
	1/4"	60 36 75 1	60 36 75 2	60 36 75 3	60 36 75 4
mat finish	6	66 36 76 1	66 36 76 2	66 36 76 3	66 36 76 4
	1/4"	66 36 75 1	66 36 75 2	66 36 75 3	66 36 75 4

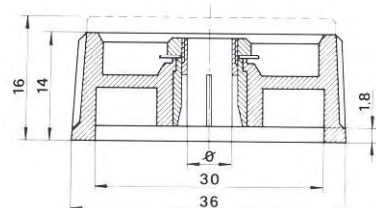

mit Strich — avec repère — with line

61 36 76 1	61 36 76 2	61 36 76 3	61 36 76 4	
61 36 75 1	61 36 75 2	61 36 75 3	61 36 75 4	
67 36 76 1	67 36 76 2	67 36 76 3	67 36 76 4	
67 36 75 1	67 36 75 2	67 36 75 3	67 36 75 4	

21 mm

Kurzkebelknopf
Bouton court à oreilles
Short wing knob

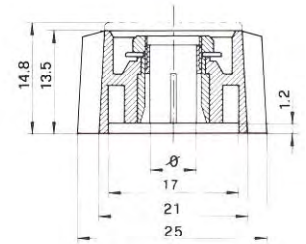

	Ø								
standard	3	62 21 36 1	62 21 36 2	62 21 36 3	62 21 36 4	63 21 36 1	63 21 36 2	63 21 36 3	63 21 36 4
	1/8"	62 21 37 1	62 21 37 2	62 21 37 3	62 21 37 4	63 21 37 1	63 21 37 2	63 21 37 3	63 21 37 4
	4	62 21 46 1	62 21 46 2	62 21 46 3	62 21 46 4	63 21 46 1	63 21 46 2	63 21 46 3	63 21 46 4
	6	62 21 76 1	62 21 76 2	62 21 76 3	62 21 76 4	63 21 76 1	63 21 76 2	63 21 76 3	63 21 76 4
mat finish	1/4"	62 21 75 1	62 21 75 2	62 21 75 3	62 21 75 4	63 21 75 1	63 21 75 2	63 21 75 3	63 21 75 4
	3	68 21 36 1	68 21 36 2	68 21 36 3	68 21 36 4	69 21 36 1	69 21 36 2	69 21 36 3	69 21 36 4
	1/8"	68 21 37 1	68 21 37 2	68 21 37 3	68 21 37 4	69 21 37 1	69 21 37 2	69 21 37 3	69 21 37 4
	4	68 21 46 1	68 21 46 2	68 21 46 3	68 21 46 4	69 21 46 1	69 21 46 2	69 21 46 3	69 21 46 4
1/4"	6	68 21 76 1	68 21 76 2	68 21 76 3	68 21 76 4	69 21 76 1	69 21 76 2	69 21 76 3	69 21 76 4
	6	68 21 75 1	68 21 75 2	68 21 75 3	68 21 75 4	69 21 75 1	69 21 75 2	69 21 75 3	69 21 75 4

mit Strich — avec repère — with line

28 mm

Kurzkebelknopf
Bouton court à oreilles
Short wing knob

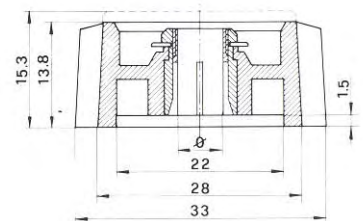

	Ø								
standard	4	62 28 46 1	62 28 46 2	62 28 46 3	62 28 46 4	63 28 46 1	63 28 46 2	63 28 46 3	63 28 46 4
	6	62 28 76 1	62 28 76 2	62 28 76 3	62 28 76 4	63 28 76 1	63 28 76 2	63 28 76 3	63 28 76 4
	1/4"	62 28 75 1	62 28 75 2	62 28 75 3	62 28 75 4	63 28 75 1	63 28 75 2	63 28 75 3	63 28 75 4
mat finish	4	68 28 46 1	68 28 46 2	68 28 46 3	68 28 46 4	69 28 46 1	69 28 46 2	69 28 46 3	69 28 46 4
	6	68 28 76 1	68 28 76 2	68 28 76 3	68 28 76 4	69 28 76 1	69 28 76 2	69 28 76 3	69 28 76 4
	1/4"	68 28 75 1	68 28 75 2	68 28 75 3	68 28 75 4	69 28 75 1	69 28 75 2	69 28 75 3	69 28 75 4

mit Strich — avec repère — with line

36 mm

Kurzkebelknopf
Bouton court à oreilles
Short wing knob

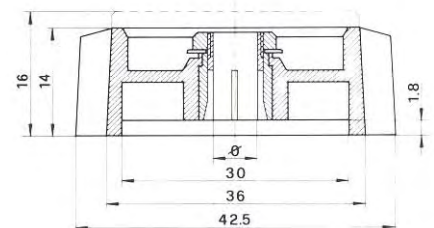

	Ø								
standard	6	62 36 76 1	62 36 76 2	62 36 76 3	62 36 76 4	63 36 76 1	63 36 76 2	63 36 76 3	63 36 76 4
	1/4"	62 36 75 1	62 36 75 2	62 36 75 3	62 36 75 4	63 36 75 1	63 36 75 2	63 36 75 3	63 36 75 4
mat finish	6	68 36 76 1	68 36 76 2	68 36 76 3	68 36 76 4	69 36 76 1	69 36 76 2	69 36 76 3	69 36 76 4
	1/4"	68 36 75 1	68 36 75 2	68 36 75 3	68 36 75 4	69 36 75 1	69 36 75 2	69 36 75 3	69 36 75 4

mit Strich — avec repère — with line

Pfeilscheibe/Zahlenscheibe – Disque à flèche/Cadran – Arrow dial/Figure dial

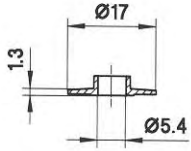

8 mm

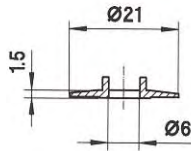

10 mm

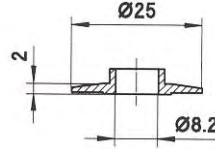

13 mm

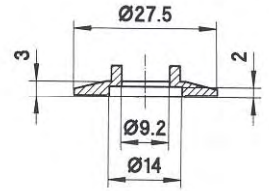

15 mm

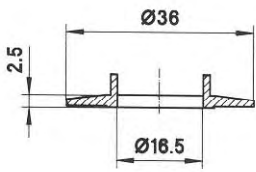

21 mm

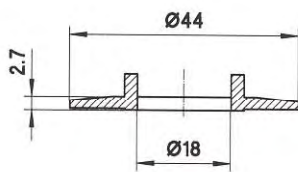

28 mm

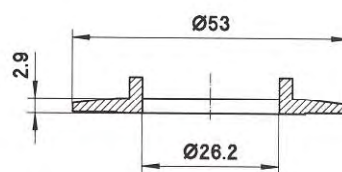

36 mm

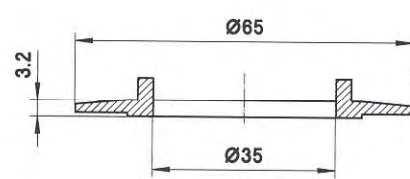

45 mm

Stator

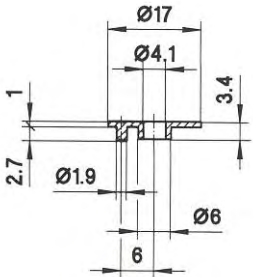

8 mm

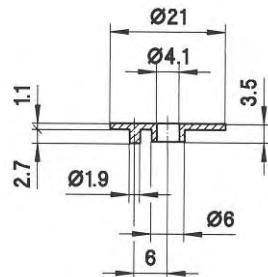

10 mm

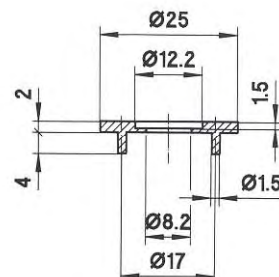

13 mm

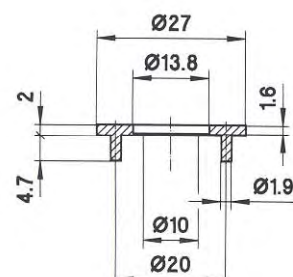

15 mm

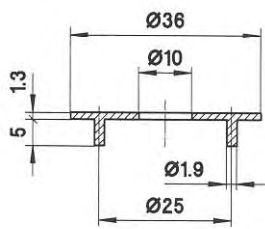
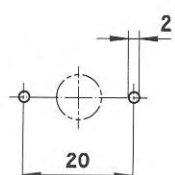
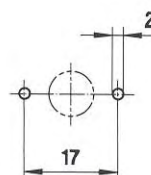
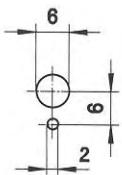
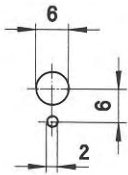

21 mm

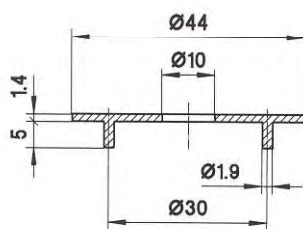

28 mm

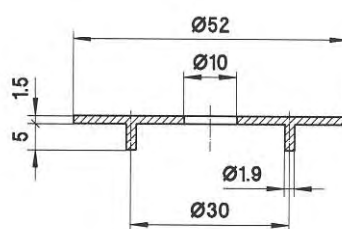

36 mm

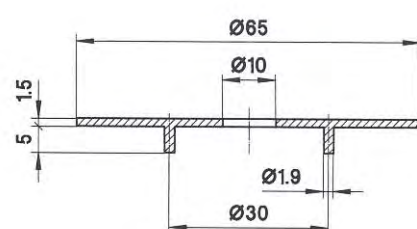

45 mm

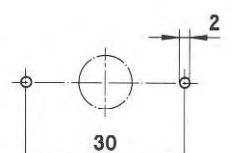
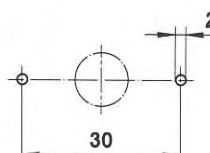
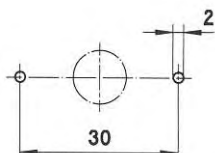
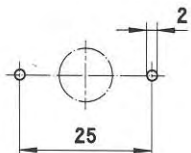

Zahlenscheibe — Cadran — Figure dial

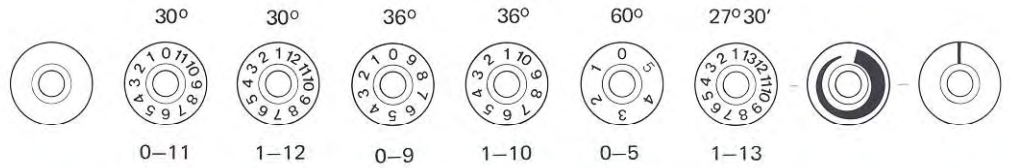

8 mm	46 08 00 0	46 08 01 0	46 08 02 0	46 08 03 0	46 08 04 0	46 08 05 0	46 08 06 0	46 08 10 0	46 08 11 0
10 mm	46 10 00 0	46 10 01 0	46 10 02 0	46 10 03 0	46 10 04 0	46 10 05 0	46 10 06 0	46 10 10 0	46 10 11 0
13 mm	46 13 00 0	46 13 01 0	46 13 02 0	46 13 03 0	46 13 04 0	46 13 05 0	46 13 06 0	46 13 10 0	46 13 11 0
15 mm	46 15 00 0	46 15 01 0	46 15 02 0	46 15 03 0	46 15 04 0	46 15 05 0	46 15 06 0	46 15 10 0	46 15 11 0
21 mm	46 21 00 0	46 21 01 0	46 21 02 0	46 21 03 0	46 21 04 0	46 21 05 0	46 21 06 0	46 21 10 0	46 21 11 0
28 mm	46 28 00 0	46 28 01 0	46 28 02 0	46 28 03 0	46 28 04 0	46 28 05 0	46 28 06 0	46 28 10 0	46 28 11 0
36 mm	46 36 00 0	46 36 01 0	46 36 02 0	46 36 03 0	46 36 04 0	46 36 05 0	46 36 06 0	46 36 10 0	46 36 11 0
45 mm	46 45 00 0	46 45 01 0	46 45 02 0	46 45 03 0	46 45 04 0	46 45 05 0	46 45 06 0	46 45 10 0	46 45 11 0

Pfeilscheibe — Disque à flèche — Arrow dial

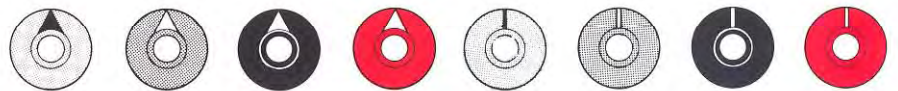

8 mm	standard	45 08 01 1	45 08 01 2	45 08 01 3	45 08 01 4	45 08 02 1	45 08 02 2	45 08 02 3	45 08 02 4
	mat finish	45 08 11 1	45 08 11 2	45 08 11 3	45 08 11 4	45 08 12 1	45 08 12 2	45 08 12 3	45 08 12 4
10 mm	standard	45 10 01 1	45 10 01 2	45 10 01 3	45 10 01 4	45 10 02 1	45 10 02 2	45 10 02 3	45 10 02 4
	mat finish	45 10 11 1	45 10 11 2	45 10 11 3	45 10 11 4	45 10 12 1	45 10 12 2	45 10 12 3	45 10 12 4
13 mm	standard	45 13 01 1	45 13 01 2	45 13 01 3	45 13 01 4	45 13 02 1	45 13 02 2	45 13 02 3	45 13 02 4
	mat finish	45 13 11 1	45 13 11 2	45 13 11 3	45 13 11 4	45 13 12 1	45 13 12 2	45 13 12 3	45 13 12 4
15 mm	standard	45 15 01 1	45 15 01 2	45 15 01 3	45 15 01 4	45 15 02 1	45 15 02 2	45 15 02 3	45 15 02 4
	mat finish	45 15 11 1	45 15 11 2	45 15 11 3	45 15 11 4	45 15 12 1	45 15 12 2	45 15 12 3	45 15 12 4
21 mm	standard	45 21 01 1	45 21 01 2	45 21 01 3	45 21 01 4	45 21 02 1	45 21 02 2	45 21 02 3	45 21 02 4
	mat finish	45 21 11 1	45 21 11 2	45 21 11 3	45 21 11 4	45 21 12 1	45 21 12 2	45 21 12 3	45 21 12 4
28 mm	standard	45 28 01 1	45 28 01 2	45 28 01 3	45 28 01 4	45 28 02 1	45 28 02 2	45 28 02 3	45 28 02 4
	mat finish	45 28 11 1	45 28 11 2	45 28 11 3	45 28 11 4	45 28 12 1	45 28 12 2	45 28 12 3	45 28 12 4
36 mm	standard	45 36 01 1	45 36 01 2	45 36 01 3	45 36 01 4	45 36 02 1	45 36 02 2	45 36 02 3	45 36 02 4
	mat finish	45 36 11 1	45 36 11 2	45 36 11 3	45 36 11 4	45 36 12 1	45 36 12 2	45 36 12 3	45 36 12 4
45 mm	standard	45 45 01 1	45 45 01 2	45 45 01 3	45 45 01 4	45 45 02 1	45 45 02 2	45 45 02 3	45 45 02 4
	mat finish	45 45 11 1	45 45 11 2	45 45 11 3	45 45 11 4	45 45 12 1	45 45 12 2	45 45 12 3	45 45 12 4

Stator

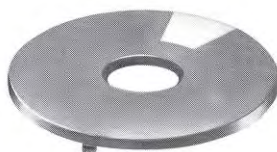

8 mm	47 08 01 1	8 mm	47 08 02 3
10 mm	47 10 01 1	10 mm	47 10 02 3
13 mm	47 13 01 1	13 mm	47 13 02 3
15 mm	47 15 01 1	15 mm	47 15 02 3
21 mm	47 21 01 1	21 mm	47 21 02 3
28 mm	47 28 01 1	28 mm	47 28 02 3
36 mm	47 36 01 1	36 mm	47 36 02 3
45 mm	47 45 01 1	45 mm	47 45 02 3

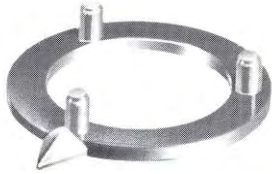

Pfeil – Flèche – Arrow



8 mm	standard mat finish	40 08 00 1 40 08 10 1	40 08 00 2 40 08 10 2	40 08 00 3 40 08 10 3	40 08 00 4 40 08 10 4	40 08 00 5 40 08 10 5	40 08 00 6 40 08 10 6	40 08 00 7 40 08 10 7
10 mm	standard mat finish	40 10 00 1 40 10 10 1	40 10 00 2 40 10 10 2	40 10 00 3 40 10 10 3	40 10 00 4 40 10 10 4	40 10 00 5 40 10 10 5	40 10 00 6 40 10 10 6	40 10 00 7 40 10 10 7
13 mm	standard mat finish	40 13 00 1 40 13 10 1	40 13 00 2 40 13 10 2	40 13 00 3 40 13 10 3	40 13 00 4 40 13 10 4	40 13 00 5 40 13 10 5	40 13 00 6 40 13 10 6	40 13 00 7 40 13 10 7
15 mm	standard mat finish	40 15 00 1 40 15 10 1	40 15 00 2 40 15 10 2	40 15 00 3 40 15 10 3	40 15 00 4 40 15 10 4	40 15 00 5 40 15 10 5	40 15 00 6 40 15 10 6	40 15 00 7 40 15 10 7
21 mm	standard mat finish	40 21 00 1 40 21 10 1	40 21 00 2 40 21 10 2	40 21 00 3 40 21 10 3	40 21 00 4 40 21 10 4	40 21 00 5 40 21 10 5	40 21 00 6 40 21 10 6	40 21 00 7 40 21 10 7
28 mm	standard mat finish	40 28 00 1 40 28 10 1	40 28 00 2 40 28 10 2	40 28 00 3 40 28 10 3	40 28 00 4 40 28 10 4	40 28 00 5 40 28 10 5	40 28 00 6 40 28 10 6	40 28 00 7 40 28 10 7
36 mm	standard mat finish	40 36 00 1 40 36 10 1	40 36 00 2 40 36 10 2	40 36 00 3 40 36 10 3	40 36 00 4 40 36 10 4	40 36 00 5 40 36 10 5	40 36 00 6 40 36 10 6	40 36 00 7 40 36 10 7
45 mm	standard mat finish	40 45 00 1 40 45 10 1	40 45 00 2 40 45 10 2	40 45 00 3 40 45 10 3	40 45 00 4 40 45 10 4	40 45 00 5 40 45 10 5	40 45 00 6 40 45 10 6	40 45 00 7 40 45 10 7

Pfeil – Flèche – Arrow

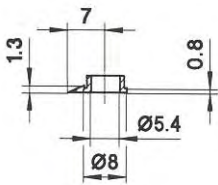

8 mm

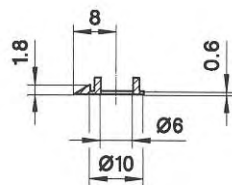

10 mm

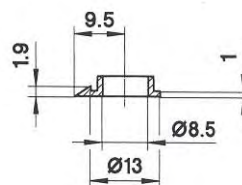

13 mm

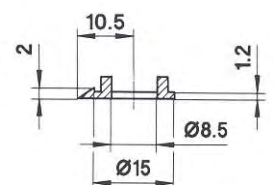

15 mm

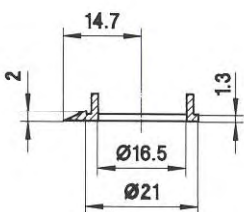

21 mm

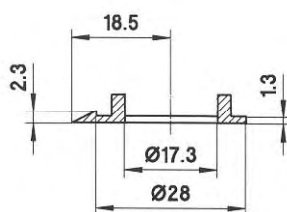

28 mm

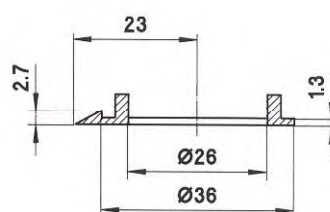

36 mm

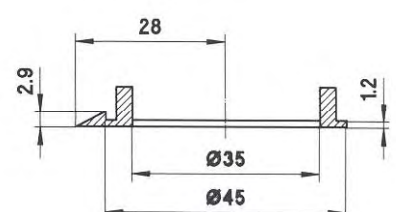

45 mm

Mutterabdeckung – Jupe – Nut cover

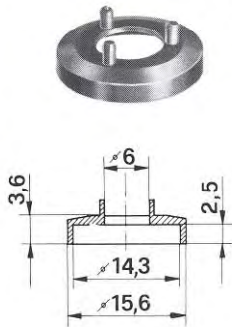

Ø 10 mm

ohne Strich

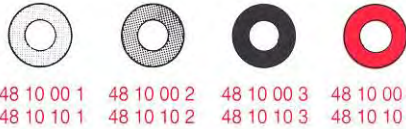

standard
mat finish

48 10 00 1 48 10 00 2 48 10 00 3 48 10 00 4
48 10 10 1 48 10 10 2 48 10 10 3 48 10 10 4

mit Strich

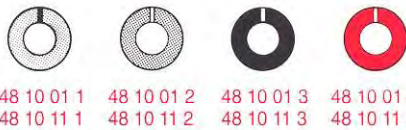

standard
mat finish

48 10 01 1 48 10 01 2 48 10 01 3 48 10 01 4
48 10 11 1 48 10 11 2 48 10 11 3 48 10 11 4

mit Strich für Knebelknöpfe
avec trait pour boutons à oreilles
with line for wing knobs

standard
mat finish

48 10 02 1 48 10 02 2 48 10 02 3 48 10 02 4
48 10 12 1 48 10 12 2 48 10 12 3 48 10 12 4

mit Pfeil

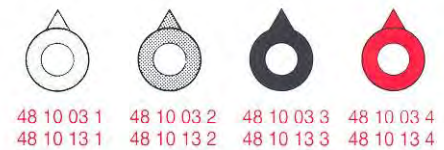
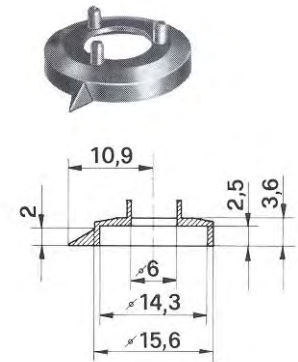

48 10 03 1 48 10 03 2 48 10 03 3 48 10 03 4
48 10 13 1 48 10 13 2 48 10 13 3 48 10 13 4

Ø 13 mm

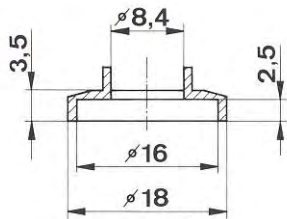

standard
mat finish

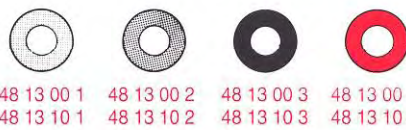

48 13 00 1 48 13 00 2 48 13 00 3 48 13 00 4
48 13 10 1 48 13 10 2 48 13 10 3 48 13 10 4

mit Strich

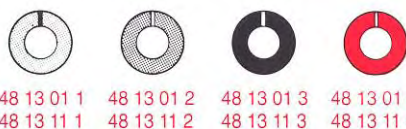

standard
mat finish

48 13 01 1 48 13 01 2 48 13 01 3 48 13 01 4
48 13 11 1 48 13 11 2 48 13 11 3 48 13 11 4

mit Strich für Knebelknöpfe
avec trait pour boutons à oreilles
with line for wing knobs

standard
mat finish

48 13 02 1 48 13 02 2 48 13 02 3 48 13 02 4
48 13 12 1 48 13 12 2 48 13 12 3 48 13 12 4

Ø 15 mm

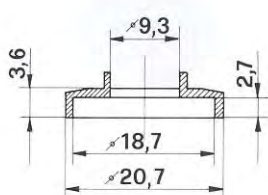

15 mm

standard
mat finish

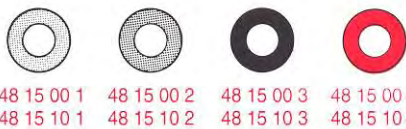

48 15 00 1 48 15 00 2 48 15 00 3 48 15 00 4
48 15 10 1 48 15 10 2 48 15 10 3 48 15 10 4

mit Strich



standard
mat finish

48 15 01 1 48 15 01 2 48 15 01 3 48 15 01 4
48 15 11 1 48 15 11 2 48 15 11 3 48 15 11 4

mit Strich für Knebelknöpfe
avec trait pour boutons à oreilles
with line for wing knobs

standard
mat finish

48 15 02 1 48 15 02 2 48 15 02 3 48 15 02 4
48 15 12 1 48 15 12 2 48 15 12 3 48 15 12 4

mit Pfeil

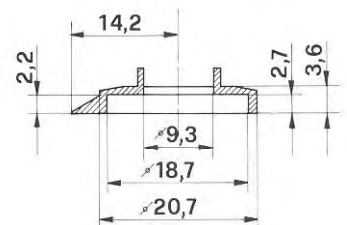

48 15 03 1 48 15 03 2 48 15 03 3 48 15 03 4
48 15 13 1 48 15 13 2 48 15 13 3 48 15 13 4

48 15 04 1 48 15 04 2 48 15 04 3 48 15 04 4
48 15 14 1 48 15 14 2 48 15 14 3 48 15 14 4

Knöpfe mit durchgehender Spannzange

Boutons avec pince de serrage coaxiale
Knobs with coaxial collets

Spannzange – Pince de serrage – Collet

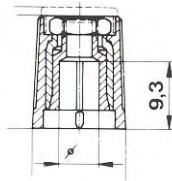

	∅ 3 mm	= 36
	∅ 1/8"	= 37
	∅ 4 mm	= 46
	∅ 6 mm	= 70
13 mm	∅ 1/4"	= 71

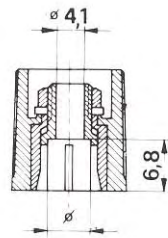

Spannzange – Pince de serrage – Collet

	∅ 3 mm	= 36
	∅ 1/8"	= 37
	∅ 4 mm	= 46
	∅ 6 mm	= 70
15 mm	∅ 1/4"	= 71

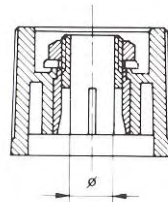

	∅ 3 mm	= 36
	∅ 1/8"	= 37
	∅ 4 mm	= 46
	∅ 6 mm	= 76
21–45 mm	∅ 1/4"	= 75

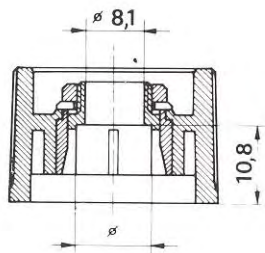

	∅ 8 mm	= 80*
28–45 mm	∅ 10 mm	= 10*

*Für Pfeilknopf 28 mm nicht lieferbar
*Pour bouton à flèche 28 mm non livrable
*Not available for arrow knob 28 mm

Für Knöpfe mit durchgehender Spannzange ändern Sie die Spannzangen-Nummer, alle Angaben finden Sie auf den entsprechenden Seiten.

Pour boutons avec pince coaxiale rechanger que les numéros de pince de serrage, vous trouverez tous les autres informations sur les pages correspondantes.

For knobs with coaxial collets change the collets according to their code-numbers, you will find all further information on corresponding pages.

Bestellcode – Code de commande – Order code

29	21	76	3		
				Farbe Couleur Colour	
				Spannzange Pince de serrage Collet	
					Seite/Page
					13 mm 10
					15 mm 12
				Knopfgröße Diamètre du bouton Knob size	21 mm 14
					28 mm 16
					36 mm 18
					45 mm 20
				Knopfform Forme du bouton Knob design	



Beispiele – Exemples – Examples

				Seite/Page
①	Deckel 15 mm, mat finish, grau Capuchon 15 mm, mat finish, gris Cap 15 mm, mat finish, grey	30 15 10 1		13
②	Knopf 15 mm, mat finish, schwarz, Spannzange 4 mm Bouton 15 mm, mat finish, noir, pince de serrage 4 mm Knob 15 mm, mat finish, black, collet 4 mm	26 15 40 3		12
③	Zwischendeckel 21 mm, mat finish, grau Capuchon intermédiaire 21 mm, mat finish, gris Intermediate cap 21 mm, mat finish, grey	38 21 10 1		31
④	Knebelknopf 21 mm, mit Strich, mat finish, schwarz, Spannzange 6 mm Bouton à oreilles 21 mm, avec repère, mat finish, noir, pince de serrage 6 mm Wing knob 21 mm, with line, mat finish, black, collet 6 mm	29 21 76 3		14
⑤	Deckel 21 mm, mat finish, grau Capuchon 21 mm, mat finish, gris Cap 21 mm, mat finish, grey	30 21 10 1		15
⑥	Kurzknopf 21 mm, mat finish, schwarz, Spannzange 4 mm Bouton court 21 mm, mat finish, noir, pince de serrage 4 mm Short knob 21 mm, mat finish, black, collet 4 mm	66 21 46 3		24
⑦	Zwischendeckel 28 mm, mat finish, grau Capuchon intermédiaire 28 mm, mat finish, gris Intermediate cap 28 mm, mat finish, grey	38 28 10 1		31
⑧	Kurzknobelknopf 28 mm, mat finish, schwarz, Spannzange 6 mm Bouton court à oreilles 28 mm, mat finish, noir, pince de serrage 6 mm Wing knob short 28 mm, mat finish, black, collet 6 mm	68 28 76 3		25

Zwischendeckel – Capuchon intermédiaire – Intermediate cap



	φ					
15 mm	4,5	standard mat finish	38 15 00 1 38 15 10 1	38 15 00 2 38 15 10 2	38 15 00 3 38 15 10 3	38 15 00 4 38 15 10 4
21 mm	6,5	standard mat finish	38 21 00 1 38 21 10 1	38 21 00 2 38 21 10 2	38 21 00 3 38 21 10 3	38 21 00 4 38 21 10 4
28 mm	6,5	standard mat finish	38 28 00 1 38 28 10 1	38 28 00 2 38 28 10 2	38 28 00 3 38 28 10 3	38 28 00 4 38 28 10 4
36 mm	6,5	standard mat finish	38 36 00 1 38 36 10 1	38 36 00 2 38 36 10 2	38 36 00 3 38 36 10 3	38 36 00 4 38 36 10 4
45 mm	6,5	standard mat finish	38 45 00 1 38 45 10 1	38 45 00 2 38 45 10 2	38 45 00 3 38 45 10 3	38 45 00 4 38 45 10 4

Das RITEL Steckknopfprogramm ist eine Erweiterung zu den bestehenden Spannzangenknöpfen und speziell für Grossverbraucher gedacht.

In Design, Mass und Farbe ist der Steckknopf den übrigen Drehknöpfen angepasst. Sämtliches Zubehör kann wie üblich verwendet werden.

Die Achsmasse sind den DIN- und MIL-Normen angepasst.

Erhältlich für folgende Achsen: 3 mm, 1/8", 4 mm, 6 mm, 1/4".

4 Knopfdurchmesser: \varnothing 10, 15, 21, 28.

Vorteile der Steckknöpfe: preiswert, kurze Montagezeit, eindeutige Positionierung.

La gamme RITEL de boutons à enfoncer vient compléter la série existante de boutons à collet et est destinée en particulier aux grands consommateurs.

La construction, la dimension et la couleur sont adaptées aux boutons à collet et tous les accessoires peuvent également être utilisés.

Les dimensions d'axe sont adaptées aux normes DIN et MIL.

Disponibles pour axes 3 mm, 1/8", 4 mm, 6 mm, 1/4".

4 dimensions de boutons: \varnothing 10, 15, 21 et 28 mm.

Avantages: prix modique, montage rapide, fixation claire.

The RITEL "push on" knob program is an enlargement of the existing collet knob program and especially made for large-scale consumers.

In its design, size and colour, the "push on" knob is adapted to the collet knob. All accessories can be used too.

The shaft dimensions are adapted to the DIN and MIL norms.

Available for shaft dia. 3 mm, 1/8", 4 mm, 6 mm, 1/4".

4 knob sizes: dia. 10, 15, 21 and 28.

Advantages: low price, quick mounting, clear fixation.

Achsabmessungen

Dimensions d'axe

Shaft dimensions

DIN-Norm/Norme DIN/DIN norm		MIL-Norm/Norme MIL/MIL norm	
Achsdurchmesser \varnothing axe shaft dia.	Abflachung plat flattened	Achsdurchmesser \varnothing axe shaft dia.	Abflachung plat flattened
3 mm	2 - $\frac{0}{0.1}$ mm	1/8"	2,39 mm (0.094 inch)
4 mm	3 - $\frac{0}{0.1}$ mm	1/4"	5,49 mm (0.216 inch)
6 mm	4 - $\frac{0}{0.1}$ mm		

Lieferbare Achsdurchmesser

Diamètres d'axe en stock

Shaft dia. in stock

Achsdurchmesser \varnothing axe shaft dia.	Knopfdurchmesser \varnothing bouton knob dia.			
	10	15	21	28
3	●			
1/8"	●	●		
4	●	●	●	
6		●	●	●
1/4"		●	●	●

Die schraffierten Achsdurchmesser sind nur auf Bestellung erhältlich. Lieferzeit ca. 4 Wochen.

Les diamètres d'axe hachurés sont disponibles sur demande spéciale. Délai de livraison: quatre semaines environ.

The hatched shaft dia. are available on demand only. Delivery time: about 4 weeks.

Wir sind auch in der Lage, andere Achsmasse oder Achsausführungen (z. B. gezahnt) kurzfristig herzustellen.

Nous sommes également à même de fournir d'autres dimensions d'axe ou types différents (moletés par exemple), à bref délai.

We are also able to produce other shaft dimensions or shaft types (e.g. rimmed) in short time.



hellgrau
gris clair
light grey



schwarz
noir
black



hellgrau
mit Linie
gris clair
avec trait
light grey
with line



schwarz
mit Linie
noir
avec trait
black
with line

10 mm

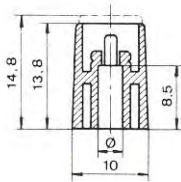

∅

3	76 10 30 1	76 10 30 3	77 10 30 1	77 10 30 3
1/8	76 10 31 1	76 10 31 3	77 10 31 1	77 10 31 3
4	76 10 40 1	76 10 40 3	77 10 40 1	77 10 40 3

15 mm

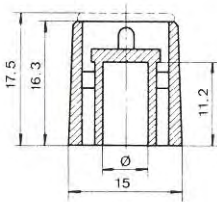

∅

1/8	76 15 31 1	76 15 31 3	77 15 31 1	77 15 31 3
4	76 15 40 1	76 15 40 3	77 15 40 1	77 15 40 3
6	76 15 60 1	76 15 60 3	77 15 60 1	77 15 60 3
1/4	76 15 61 1	76 15 61 3	77 15 61 1	77 15 61 3

21 mm

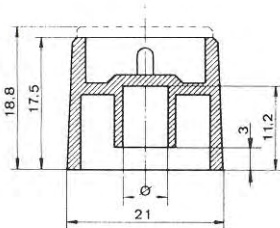

∅

4	76 21 40 1	76 21 40 3	77 21 40 1	77 21 40 3
6	76 21 60 1	76 21 60 3	77 21 60 1	77 21 60 3
1/4	76 21 61 1	76 21 61 3	77 21 61 1	77 21 61 3

28 mm

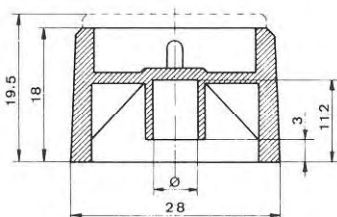

∅

6	76 28 60 1	76 28 60 3	77 28 60 1	77 28 60 3
1/4	76 28 61 1	76 28 61 3	77 28 61 1	77 28 61 3



RITEL-Industrieklemmen

- Für 4 mm Steck- und Drahtanschluss (bis ϕ 2 mm)
- mit Verdrehungsschutz
- mit unverlierbarem Berührungsschutz
- montierbar bis Frontplattenstärke von 6 mm
- Kunststoffteile Polyamid

Pinces industrielles RITEL

- Pour connexion enfichable 4 mm et par fil (jusqu'à ϕ 2 mm)
- avec dispositif antirotatoire
- avec protection imperable contre les contacts accidentels
- montables sur des platines jusqu'à 6 mm
- parties plastiques en Polyamid

RITEL industrial terminals

- For 4 mm plug and wire connection up to 2 mm dia
- with locking device
- with captive insulation against electric shock
- can be fitted to front plates up to 6 mm thickness
- plastic parts in Polyamide

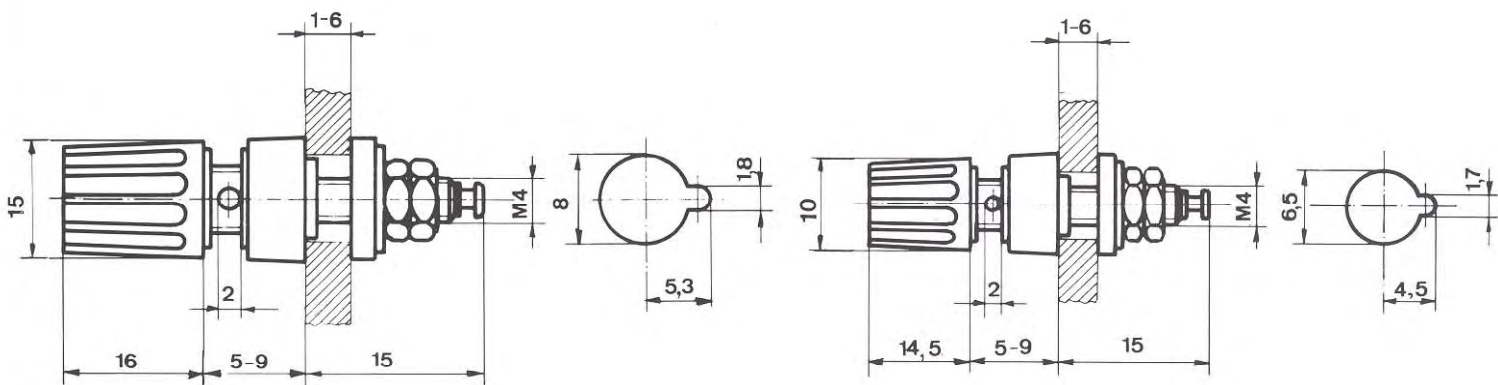

Technische Daten

	ϕ 15 mm	ϕ 10 mm
Dauerstrom:	25 Ampère	20 Ampère
Uebergangsspannung:	2500 Volt	2500 Volt
Isolationswiderstand:	10^{13} Ohm	10^{13} Ohm
Kapazität:	6 pf	3 pf

Indications

	ϕ 15 mm	ϕ 10 mm
Courant permanent:	25 Ampère	20 Ampère
Tension de contournement:	2500 Volt	2500 Volt
Résistance d'isolement:	10^{13} Ohm	10^{13} Ohm
Capacité:	6 pf	3 pf

Technical Data

	ϕ 15 mm	ϕ 10 mm
Permanent current:	25 Ampère	20 Ampère
Contact voltage:	2500 Volt	2500 Volt
Insulationres:	10^{13} Ohm	10^{13} Ohm
Capacity:	6 pf	3 pf

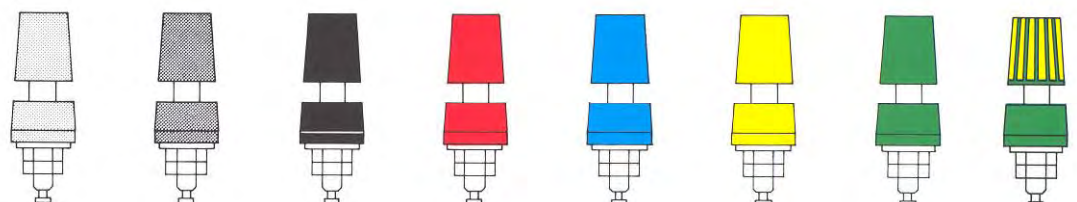

10 mm	standard mat finish	24 10 00 1 24 10 10 1	24 10 00 2 24 10 10 2	24 10 00 3 24 10 10 3	24 10 00 4 24 10 10 4	24 10 00 5 24 10 10 5	24 10 00 6 24 10 10 6	24 10 00 7 24 10 10 7	24 10 00 8
15 mm	standard mat finish	24 15 00 1 24 15 10 1	24 15 00 2 24 15 10 2	24 15 00 3 24 15 10 3	24 15 00 4 24 15 10 4	24 15 00 5 24 15 10 5	24 15 00 6 24 15 10 6	24 15 00 7 24 15 10 7	24 15 00 8

Japan	GENERAL TRADERS Ltd. No. 5, Kanda Mitoshiro-cho Chiyoda-ku Tokyo 101-0053 Japan	Phone: +81 3 32912761 Fax: +81 3 32935391
South Africa	VEPAC ELECTRONICS (PTY) Ltd. 13, 8 th Avenue P. O. Box 1438 Edenvale 1610 Südafrika	Phone: +27 11 4531910 Fax: +27 11 4537751
USA	POWER DYNAMICS Inc. 145 Algonquin Parkway Whippany N. J. 07981 USA	Phone: +1 973 560 0019 Fax: +1 973 560 0203
Israel	CVS TECHNOLOGIES 1974 Ltd. 5, Ha'arad Street Ramat-Hachayal 69710 Tel Aviv Israel	Phone: +972 3 6487475 Fax: +972 3 6474379
Belgium	VERCO s.p.r.l. Rue de Woeringen 9 B-1000 Bruxelles	Phone: +32 2 5124082 Fax: +32 2 5110353
Denmark	MIKKELSEN ELECTRONICS A/S P. O. Box 90 Havremarken 3-5 DK-3520 Farum	Phone: +45 44 34 03 00 Fax: +45 44 34 03 10
Finland	FINNEKI OY Aleksis Kiven Katu 50 P. O. Box 133 SF-00101 Helsinki	Phone: +358 9 1461211 Fax: +358 9 1461527
France	PACS ELECTRONICS 10, rue de la Digue F-94210 La Varenne Saint-Hilaire	Phone: +33 145 11 75 50 Fax: +33 145 11 75 55
Germany	Contrinex GmbH Lötscher Weg 78 D-41334 Nettetal	Phone: +49 2153 7374-0 Fax: +49 2153 7374-10
Great Britain	BULGIN COMPONENTS PLC Alfreds Way GB-Barking, Essex IG11 0AZ	Phone: +44 208 594 5588 Fax: +44 208 507 2691
Italy	FACE TRADING s.r.l. Via Enrico Fermi, 20 I-20090 Cesano Boscone (MI)	Phone: +39 02 4583050 Fax: +39 02 4503741
Netherlands	EURODIS DISTRIBUTION SERVICES Elektrostraat 17 Postbus 200 NL-7480 AD Haaksbergen	Phone: +31 53 850 50 50 Fax: +31 53 850 54 10
Norway	SKANDINAVISK ELEKTRONIKK A/S Ostre Akervei 99 N-0596 Oslo	Phone: +47 2 319 4650 Fax: +47 2 319 4651
Sweden	EG Components Sweden AB Box 39 S-16211 Vällingby	Phone: +46 8 759 35 70 Fax: +46 8 /39 85 80
Switzerland	Omni Ray AG Im Schossacher 12 CH-8600 Dübendorf	Phone: +41 1 802 28 80 Fax: +41 1 802 28 28

Ritel Ltd.
Hauptstrasse 89
CH-9113 Degersheim/Switzerland
Tel. +41 (0)71 370 00 60
Fax +41 (0)71 370 00 62
www.ritel.ch
E-mail: info@ritel.ch