

DIMENSIONS(mm)						
SIZE	A ^{+0.39} _{-0.39}	B ^{+0.25} _{-0.25}	C ^{+0.25} _{-0.25}	D ^{+0.25} _{-0.34}	E ^{+0.38} _{-0.38}	F ^{+0.25} _{-0.25}
9	30.81	24.99	16.33	7.90	12.55	10.80
15	39.19	33.32	24.66	7.90	12.55	10.80
25	53.04	47.04	38.38	7.90	12.55	10.80
37	69.32	63.50	54.84	7.90	12.55	10.80
50	67.00	61.10	52.20	10.90	15.40	13.30

MATERIAL:

SHELL: STEEL, NICKEL OR TIN PLATED
 INSULATOR: GLASS-FILLED NYLON THERMOPLASTIC, UL94 V-0
 PROCESS TEMP.: 260° PROCESS TEMPERATURE
 CONTACT: BRASS

ELECTRICAL:

CURRENT RATING: 5 AMPS
 CONTACT RESISTANCE: 15 mOhms Max.
 INSULATION RESISTANCE: 1,000 MOhms min.
 WORKING VOLTAGE: 250VAC
 TEMPERATURE: -55° C TO 125° C

172-EYY-21YRYY1

SERIES _____
 POSITIONS _____
 E09 _____
 E15 _____
 E25 _____
 E37 _____
 E50 _____
 GENDER _____
 2 = FEMALE
 TERMINATION _____
 1 = DIP SOLDER
 SHELL PLATING _____
 2 = TIN
 3 = NICKEL
 HARDWARE OPTIONS _____
 00 = NO HARDWARE
 01 = .098" CLINCH NUT (BOARD SIDE)
 02 = .236" CLINCH NUT (BOARD SIDE)
 03 = .236" CLINCH NUT (MOUNTING SIDE)
 05 = .237" 4-40 BOARD LOCK
 08 = .228" 4-40 BOARD LOCK
 90 = .237" 4-40 BOARD LOCK (FOR 0.093" BOARD MAX.)
 91 = .237" 4-40 SPACER/ BOARD LOCK
 92 = .237" 4-40 SPACER/ BOARD LOCK (FOR 0.093" BOARD MAX.)
 PLATING OPTIONS _____
 1 = GOLD FLASH
 2 = 30 MICRO-INCH GOLD
 3 = 50 MICRO-INCH GOLD
 5 = 15 MICRO-INCH GOLD

RoHS COMPLIANT

UNITS = mm

DO NOT SCALE FROM DRAWING



THESE DRAWINGS AND SPECIFICATIONS ARE THE PROPERTY OF NorComp AND SHALL NOT BE REPRODUCED, COPIED OR USED AS THE BASIS FOR THE MANUFACTURE OR SALE OF APPARATUS WITHOUT WRITTEN PERMISSION.

DRAWN:
P. JENKINS

DATE:
11/28/2005

NorComp

SCALE:
NTS

SHEET OF
1 3

REV
21

DWG NO.

172-EYY-21YRYY1

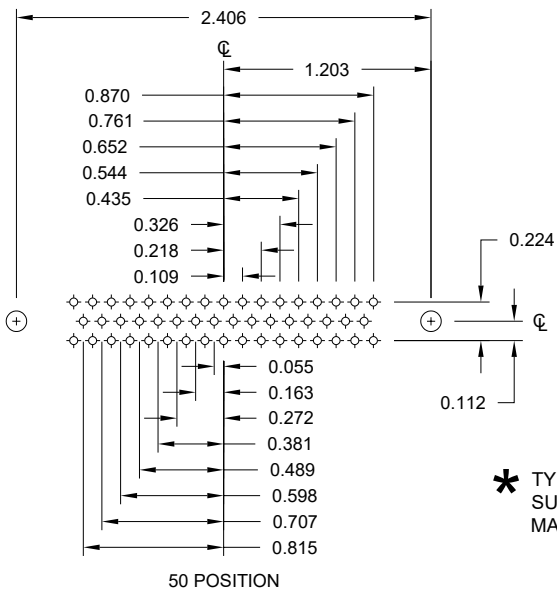
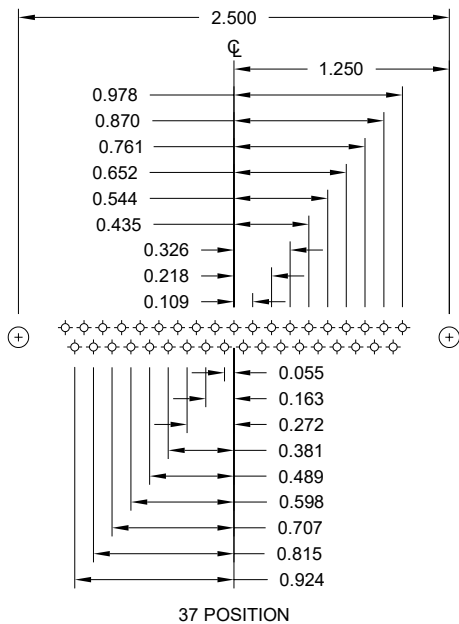
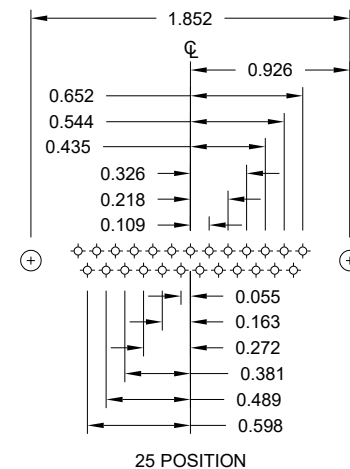
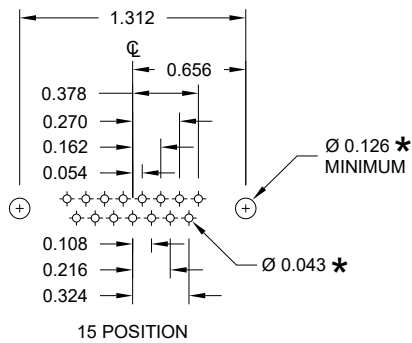
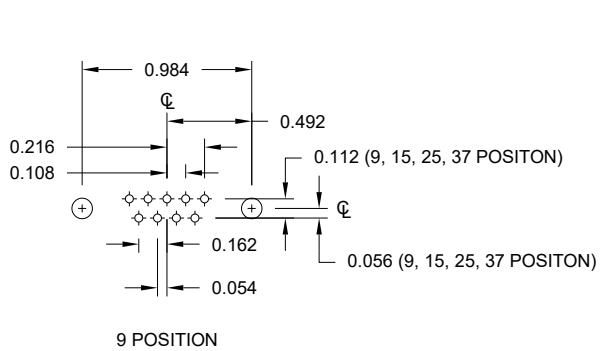

* TYP. SUGGESTED SIZE MAY NOT BE SUITABLE FOR ALL APPLICATIONS

RoHS COMPLIANT

UNITS = inch

DO NOT SCALE FROM DRAWING



THESE DRAWINGS AND SPECIFICATIONS ARE THE PROPERTY OF NorComp AND SHALL NOT BE REPRODUCED, COPIED OR USED AS THE BASIS FOR THE MANUFACTURE OR SALE OF APPARATUS WITHOUT WRITTEN PERMISSION.

DRAWN: P. JENKINS

DATE: 11/28/2005

NorComp

SCALE: NTS

SHEET 2 OF 3

REV 21

DWG NO.

172-EYY-21YRY1

ALL CLINCH-NUTS ARE 4-40 INTERNAL THREADS

01 0.098" (BOARD SIDE)

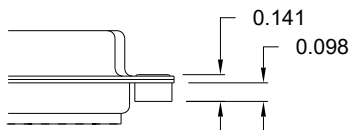

02 0.236" (BOARD SIDE)

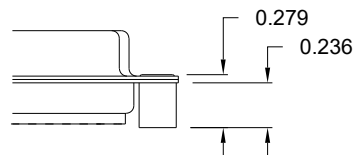

03 0.236" (MATING SIDE)

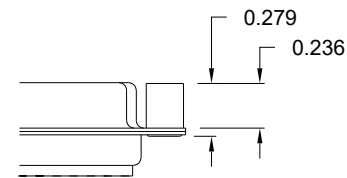

05 0.237" (BOARD SIDE)

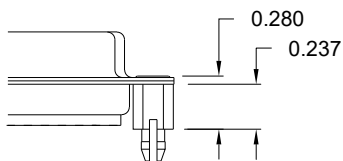

08 0.228" (BOARD SIDE)

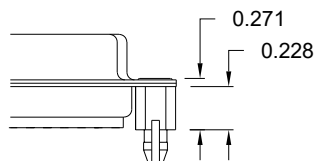

91 0.237" BOARD SIDE

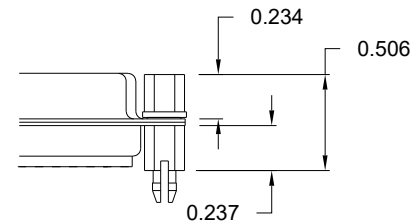

90 0.237" (BOARD SIDE)

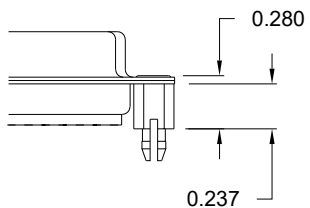

92 0.237" BOARD SIDE

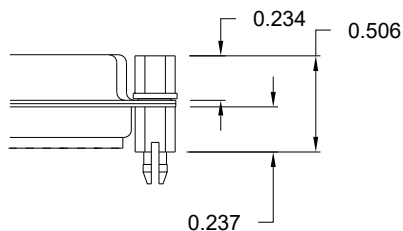

NOTE 1: 4-40 FEMALE SCREW LOCKS ARE REMOVABLE
 NOTE 2: 90 & 92 OPTIONS DESIGNED FOR 0.093" PCB THICKNESS
 NOTE 3: 05, 08, & 91 OPTIONS DESIGNED FOR 0.063" PCB THICKNESS

TOLERANCE:
 ALL DIMENSIONS ARE ± 0.010

RoHS COMPLIANT

UNITS = inch

DO NOT SCALE FROM DRAWING



THESE DRAWINGS AND SPECIFICATIONS ARE THE PROPERTY OF NorComp AND SHALL NOT BE REPRODUCED, COPIED OR USED AS THE BASIS FOR THE MANUFACTURE OR SALE OF APPARATUS WITHOUT WRITTEN PERMISSION.

DRAWN:
 P. JENKINS

DATE:
 11/28/2005

NorComp

SCALE: NTS SHEET 3 OF 3 REV 21

DWG NO. 172-EYY-21YRY1

Mouser Electronics

Authorized Distributor

Click to View Pricing, Inventory, Delivery & Lifecycle Information:

NorComp:

<u>172-E37-213R021</u>	<u>172-E37-213R011</u>	<u>172-E37-213R031</u>	<u>172-E09-213R021</u>	<u>172-E09-213R011</u>	<u>172-E09-213R031</u>
<u>172-E25-213R031</u>	<u>172-E25-213R011</u>	<u>172-E25-213R021</u>	<u>172-E50-213R021</u>	<u>172-E50-213R011</u>	<u>172-E50-213R031</u>
<u>172-E15-213R021</u>	<u>172-E15-213R031</u>	<u>172-E15-213R011</u>	<u>172-E37-213R001</u>	<u>172-E09-213R001</u>	<u>172-E25-213R001</u>
<u>172-E50-213R001</u>	<u>172-E15-213R001</u>	<u>172-E09-213R911</u>	<u>172-E15-213R911</u>	<u>172-E25-213R911</u>	<u>172-E37-213R911</u>
<u>172-E50-213R911</u>	<u>172-E15-213R051</u>	<u>172-E09-213R051</u>	<u>172-E09-213R912</u>		