

Part Number: AP23ESGC-F01

High Efficiency Red
Super Bright Green

Features

- 3mmx2.4mm SMT LED, 1.05mm thickness.
- Low power consumption.
- Wide viewing angle.
- Ideal for backlight and indicator.
- Various colors and lens types available.
- Package : 2000pcs / reel.
- Moisture sensitivity level : level 3.
- RoHS compliant.

Description

The High Efficiency Red source color devices are made with Gallium Arsenide Phosphide on Gallium Phosphide Orange Light Emitting Diode.

The Super Bright Green source color devices are made with Gallium Phosphide Green Light Emitting Diode.

Package Dimensions

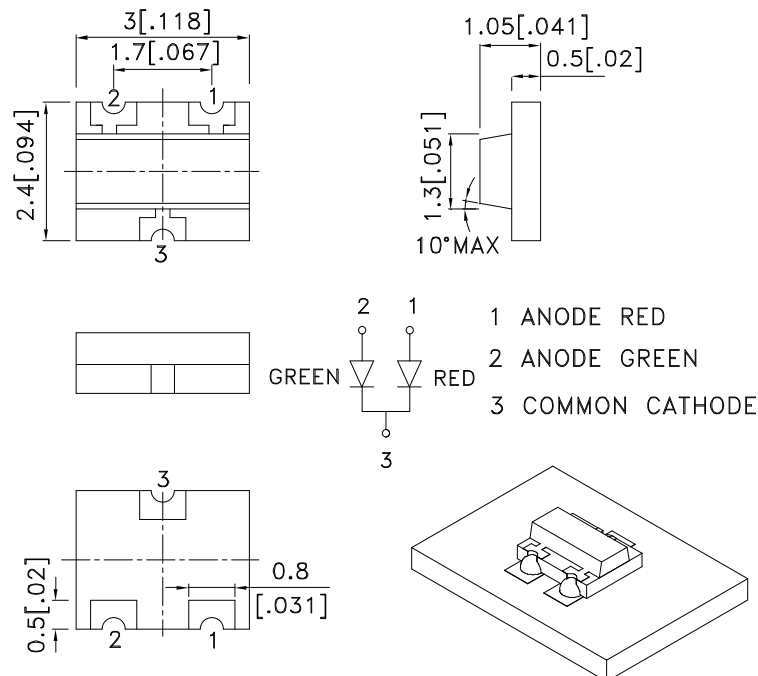

Notes:

1. All dimensions are in millimeters (inches).
2. Tolerance is ± 0.2 (0.008") unless otherwise noted.
3. Specifications are subject to change without notice.
4. The device has a single mounting surface. The device must be mounted according to the specifications.



Selection Guide

Part No.	Dice	Lens Type	Iv (mcd) [2] @ 20mA		Viewing Angle [1]
			Min.	Typ.	2θ1/2
AP23ESGC-F01	High Efficiency Red (GaAsP/GaP)	WATER CLEAR	7	20	120°
	Super Bright Green (GaP)		7	20	

Notes:

1. θ1/2 is the angle from optical centerline where the luminous intensity is 1/2 the optical centerline value.
2. Luminous intensity/ luminous Flux: +/-15%.

Electrical / Optical Characteristics at TA=25°C

Symbol	Parameter	Device	Typ.	Max.	Units	Test Conditions
λ_{peak}	Peak Wavelength	High Efficiency Red Super Bright Green	627 565		nm	I _F =20mA
λ_D [1]	Dominant Wavelength	High Efficiency Red Super Bright Green	625 568		nm	I _F =20mA
$\Delta\lambda_{1/2}$	Spectral Line Half-width	High Efficiency Red Super Bright Green	45 30		nm	I _F =20mA
C	Capacitance	High Efficiency Red Super Bright Green	15 15		pF	V _F =0V;f=1MHz
V _F [2]	Forward Voltage	High Efficiency Red Super Bright Green	2 2.2	2.5 2.5	V	I _F =20mA
I _R	Reverse Current	High Efficiency Red Super Bright Green		10 10	uA	V _R = 5V

Notes:

1. Wavelength: +/-1nm.
2. Forward Voltage: +/-0.1V.

Absolute Maximum Ratings at TA=25°C

Parameter	High Efficiency Red	Super Bright Green	Units
Power dissipation	75	62.5	mW
DC Forward Current	30	25	mA
Peak Forward Current [1]	160	140	mA
Reverse Voltage	5		V
Operating Temperature	-40°C To +85°C		
Storage Temperature	-40°C To +85°C		

Note:

1. 1/10 Duty Cycle, 0.1ms Pulse Width.

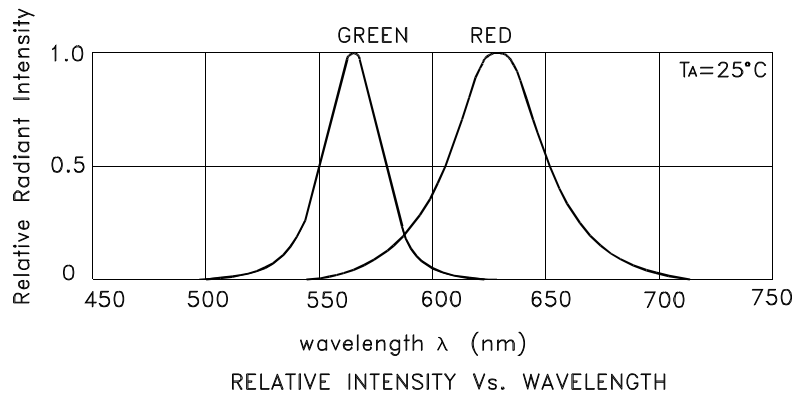

AP23ESGC-F01 High Efficiency Red

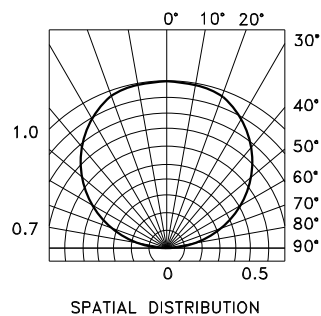
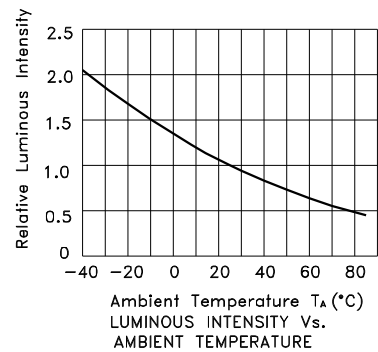
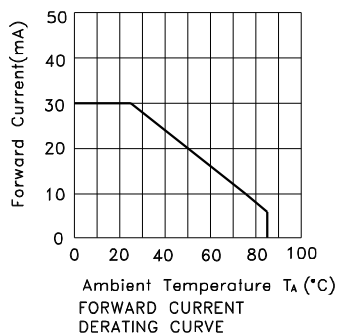
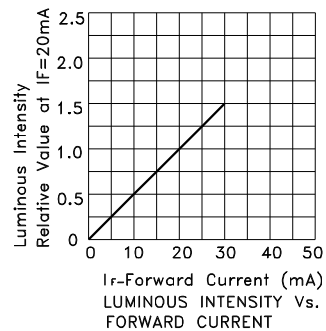
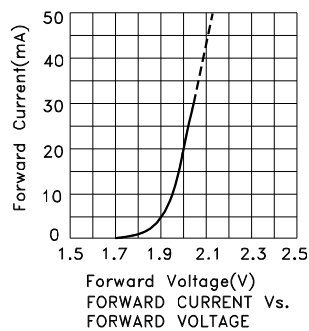

Kingbright

Super Bright Green

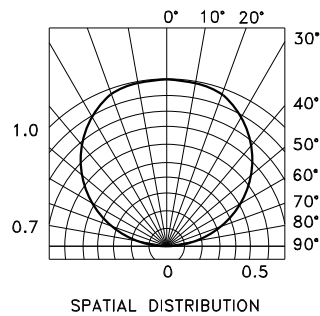
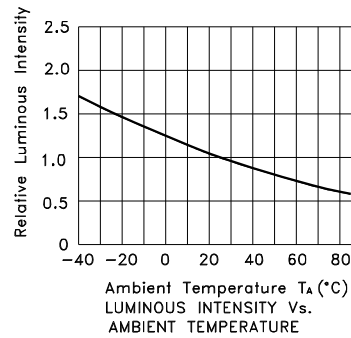
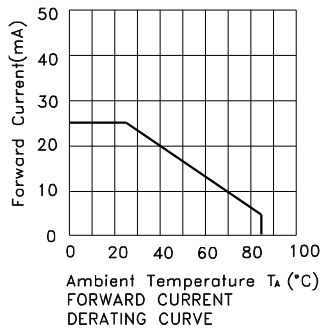
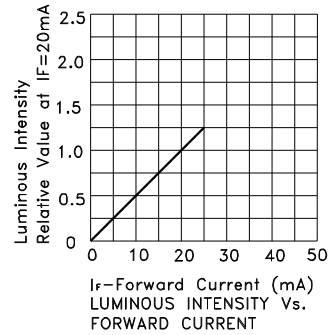
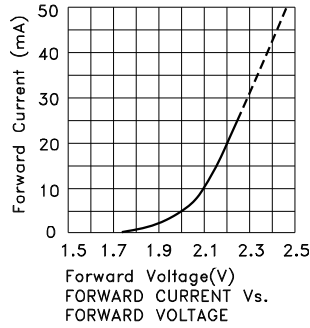

AP23ESGC-F01

Reflow soldering is recommended and the soldering profile is shown below.
Other soldering methods are not recommended as they might cause damage to the product.

Reflow Soldering Profile For Lead-free SMT Process.

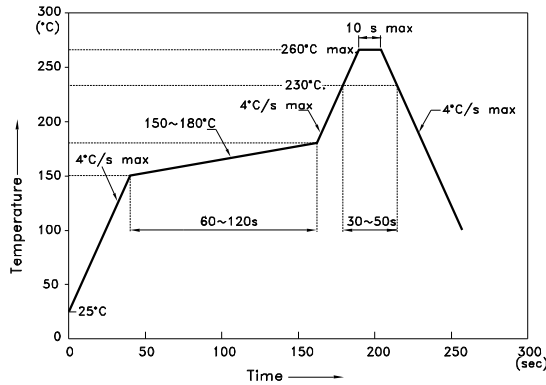

NOTES:

1. We recommend the reflow temperature 245°C(+/-5°C). The maximum soldering temperature should be limited to 260°C.
2. Don't cause stress to the epoxy resin while it is exposed to high temperature.
3. Number of reflow process shall be 2 times or less.

Recommended Soldering Pattern (Units : mm; Tolerance: ± 0.1)

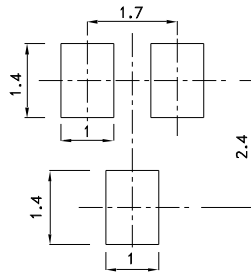

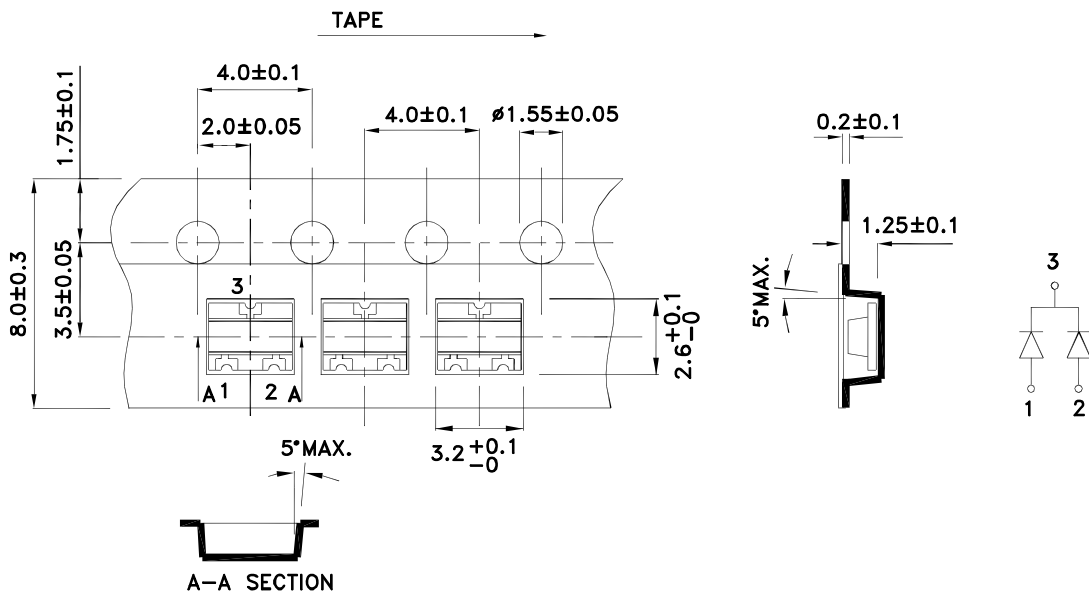

Tape Dimensions (Units : mm)

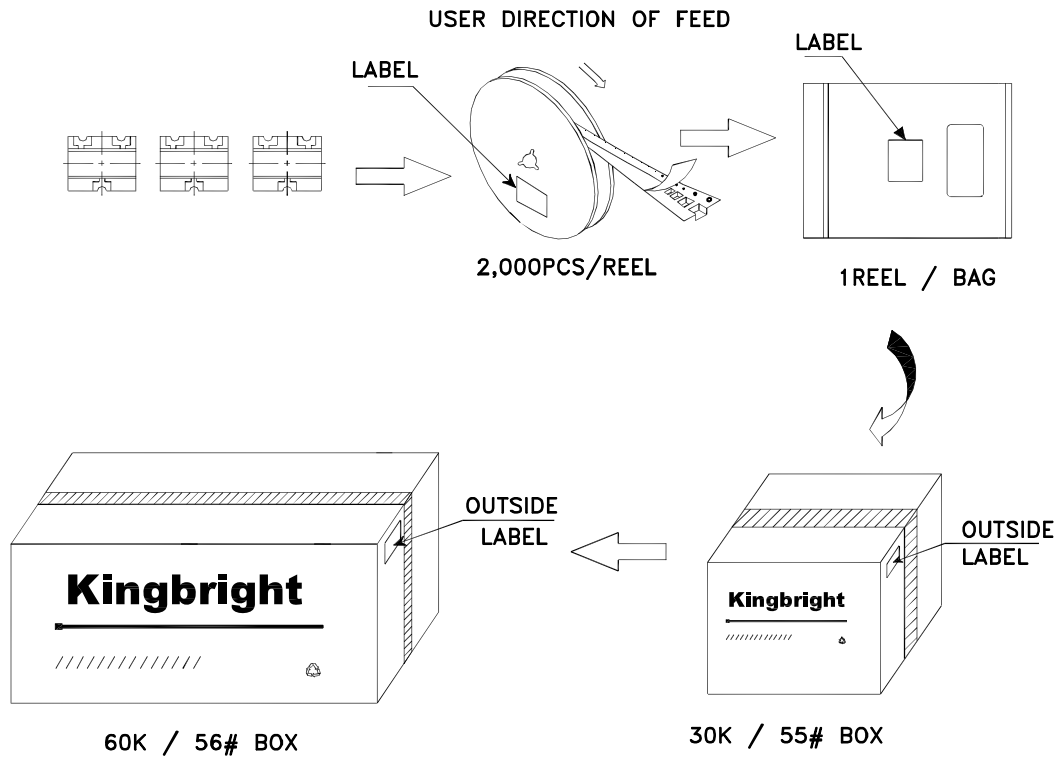

PACKING & LABEL SPECIFICATIONS

AP23ESGC-F01



Kingbright	
P/NO: AP23xxx	
QTY: 2,000 pcs	Q.C. Q C XX XX XXXX PASSED
S/N: XXXX	
CODE: XXX	
LOT NO:	
	
RoHS Compliant	

Mouser Electronics

Authorized Distributor

Click to View Pricing, Inventory, Delivery & Lifecycle Information:

[Kingbright:](#)

[AP23ESGC-F01](#)