

INTERCONNECTS

SERIES 850 & 851 • .050" GRID HORIZONTAL SURFACE MOUNT Z-BEND HEADERS & SOCKETS • SINGLE ROW STRIPS

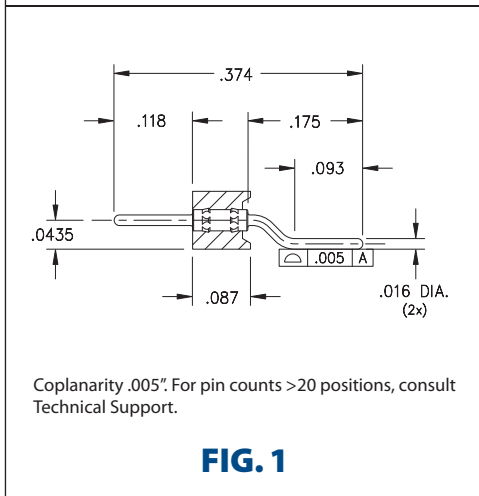
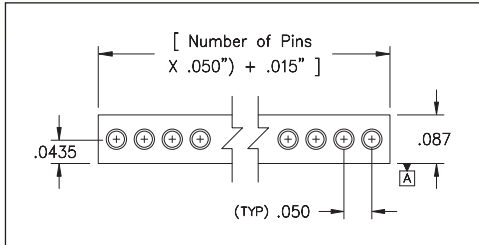

FIG. 1

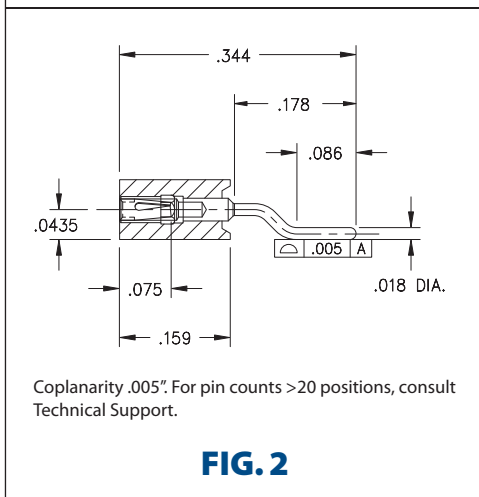
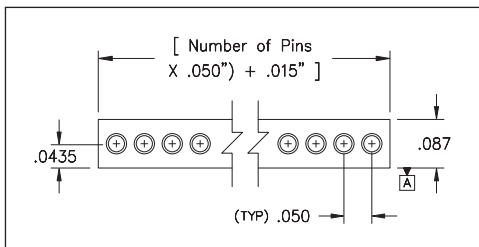
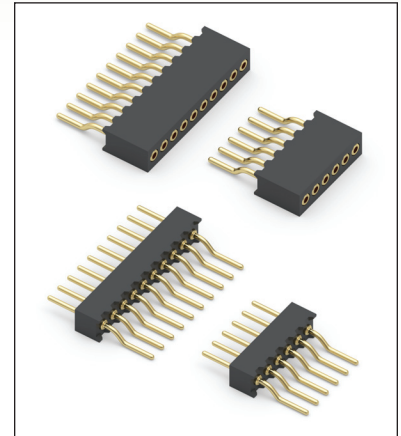

FIG. 2

- Series 850 horizontal surface mount headers have .016" dia. pluggable pins and Z-bend tails for SMT soldering to the P.C.B. (MM #4006-1). See page 208 for details
- Series 851 horizontal Surface Mount Z-Bend sockets uses MM #4890-1 receptacles that accept pin diameters from .015"-.020". See page 160 for details
- Receptacles use Hi-Rel, 3-finger BeCu #11 contact rated at 3 amps. See page 251 for details
- Insulators are high temperature thermoplastic, suitable for all soldering operations



ORDERING INFORMATION



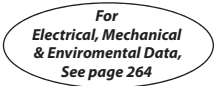



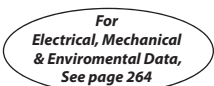

FIG. 1	Series 850...001 Single Row Surface Mount Z-Bend Header					
	850-10-0-40-001000					
	Specify number of pins		02-20			
  						
SPECIFY PLATING CODE XX=		10				
Pin Plating 		10 μ" Au				

FIG. 2	Series 851...001 Single Row Surface Mount Z-Bend Socket					
	851-XX-0-40-001000					
	Specify number of pins		02-20			
  						
SPECIFY PLATING CODE XX=		11	13			
Sleeve (Pin) 		10 μ" Au	10 μ" Au			
Contact (Clip) 		10 μ" Au	30 μ" Au			

Mouser Electronics

Authorized Distributor

Click to View Pricing, Inventory, Delivery & Lifecycle Information:

[Mill-Max:](#)

[851-13-003-40-001000](#) [850-10-003-40-001000](#) [850-10-006-40-001000](#) [851-13-002-40-001000](#)