

# TO-3228BC-MRPBFGF

## Surface Mount Device LED

Part Number	Chip		Lens Color
	Material	Source Color	
TO-3228BC-MRPBFGF	AlGaInP	Red	Water Clear
	InGaN	Green	
	InGaN	Blue	

### Features

- IC compatible
- Compatible with automatic placement equipment
- Compatible with infrared and vapor phase reflow soldering process
- Full-color type.
- Pack in 8 mm tape on 7" diameter reel
- RoHS compliant
- Moisture sensitivity Level: level 3

### Dimensions

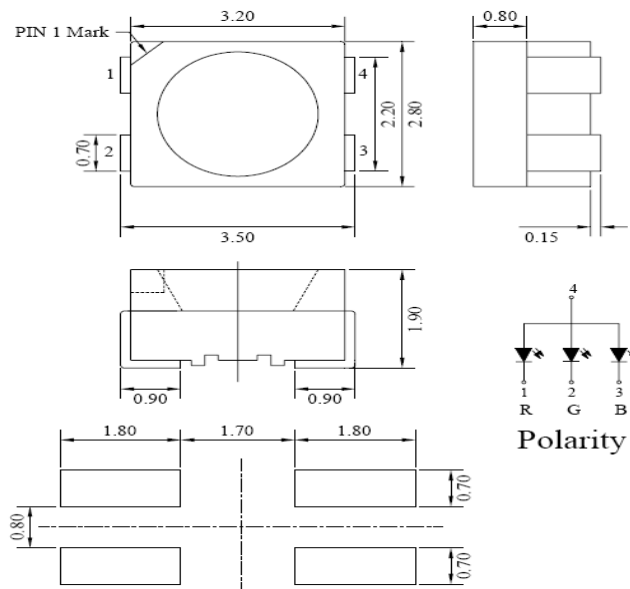

#### Notes:

1. All dimensions are in millimeter.
2. Tolerance is  $\pm 0.1$ mm unless individual mark noted.

## Absolute Maximum Rating @ Ta=25°C

Parameter	Maximum Rating			Unit
	MR	P	B	
Peak Forward Current (1/10 Duty Cycle, 0.1ms Pulse Width)	80	80	80	mA
Power Dissipation	75	105	105	mW
Continuous Forward Current	25	25	25	mA
Reverse Voltage	5	5	5	V
Operating Temperature Range	-40°C to +80°C			
Storage Temperature Range	-40°C to +100°C			
IR Reflow Soldering Profile For Lead Free Soldering	260°C for 10 sec			

## Electrical / Optical Characteristic @ Ta=25°C

Parameter	Symbol	MR			P			B			Unit	Test Condition
		Min.	Typ.	Max.	Min.	Typ.	Max.	Min.	Typ.	Max.		
Luminous Intensity	I <sub>v</sub>	146		417	417		917	146		417	lm	I <sub>F</sub> =20mA
Viewing Angle	2θ <sub>1/2</sub>		120			120			120		deg	I <sub>F</sub> =20mA
Forward Voltage	V <sub>F</sub>		1.9			3.0			3.0		V	I <sub>F</sub> =20mA
Dominant Wavelength	λ <sub>d</sub>	620		625	520		530	460		475	nm	I <sub>F</sub> =20mA
Spectral Line Half-Width	Δλ		20			25			30		nm	I <sub>F</sub> =20mA
Reverse Current	I <sub>R</sub>			10			10			10	μA	V <sub>R</sub> =5V

## Bin Code List for Reference

MR、B:

Luminous Intensity		Unit : mcd@20mA
Bin Code	Min	Max
F1	146	190
F2	190	247
F3	247	321
F4	321	417

P:

Luminous Intensity		Unit : mcd@20mA
Bin Code	Min	Max
G1	417	542
G2	542	705
G3	705	917
H1	917	1192

Tolerance of Luminous Intensity on each bin is  $\pm 11\%$

## Typical Electrical / Optical Character Curves

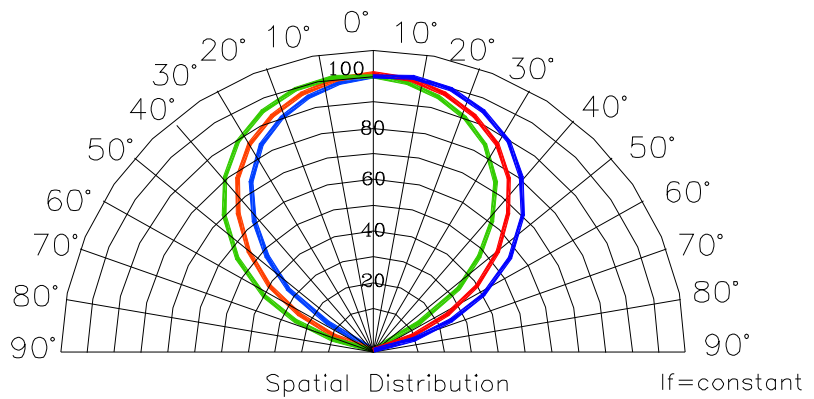
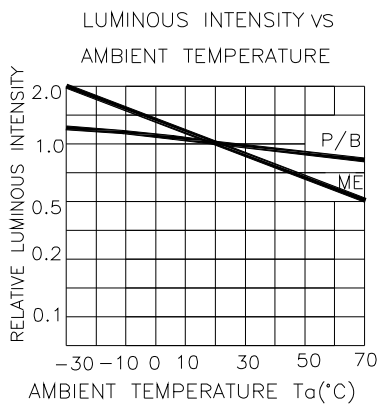
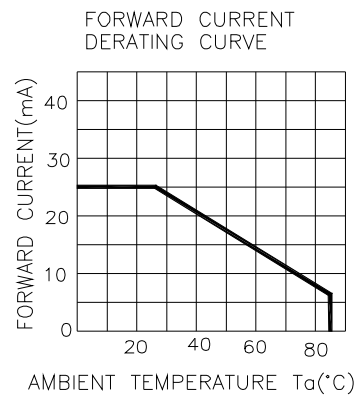
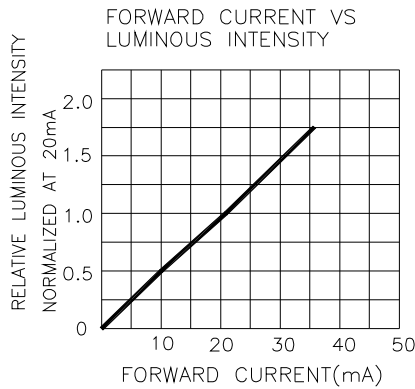
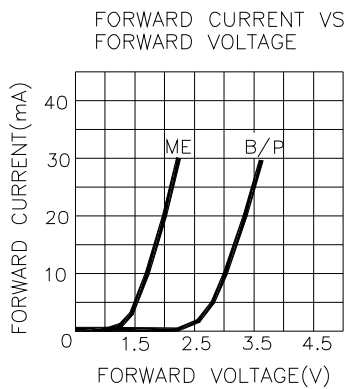
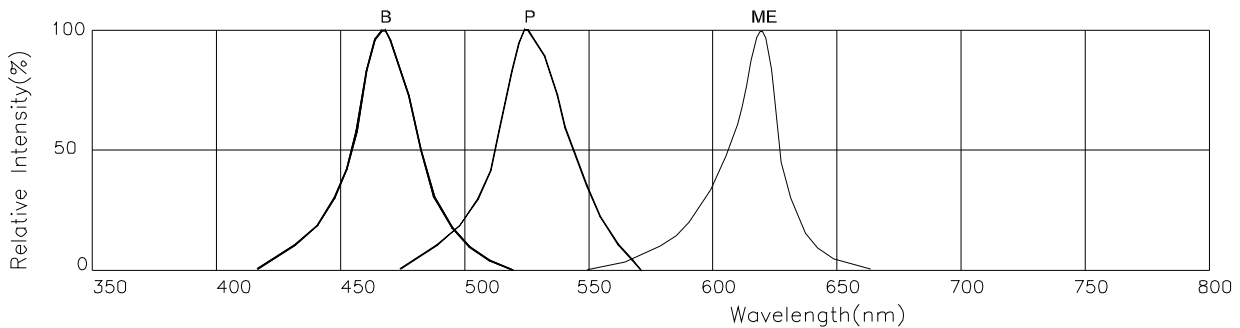

## Reliability Tests

Test Item	Test Condition	Test Time
Thermal Shock	-40°C * 30mins ~ 80°C * 30mins	300 cycles
Temperature Humidity Storage	Ta= 65°C, RH= 90%	500hours
High Temperature Storage	Ta= 100°C	500hours
Low Temperature Storage	Ta= -40°C	500hours
DC Operating Life	Ta= 25°C, 20mA	1000hours
Resistance to Soldering Heat IR-Reflow Normal Process	Refer to recommended profile	1 time
Resistance to Soldering Heat IR-Reflow Pb Free Process	Refer to recommended profile	1 time

**Package Description**

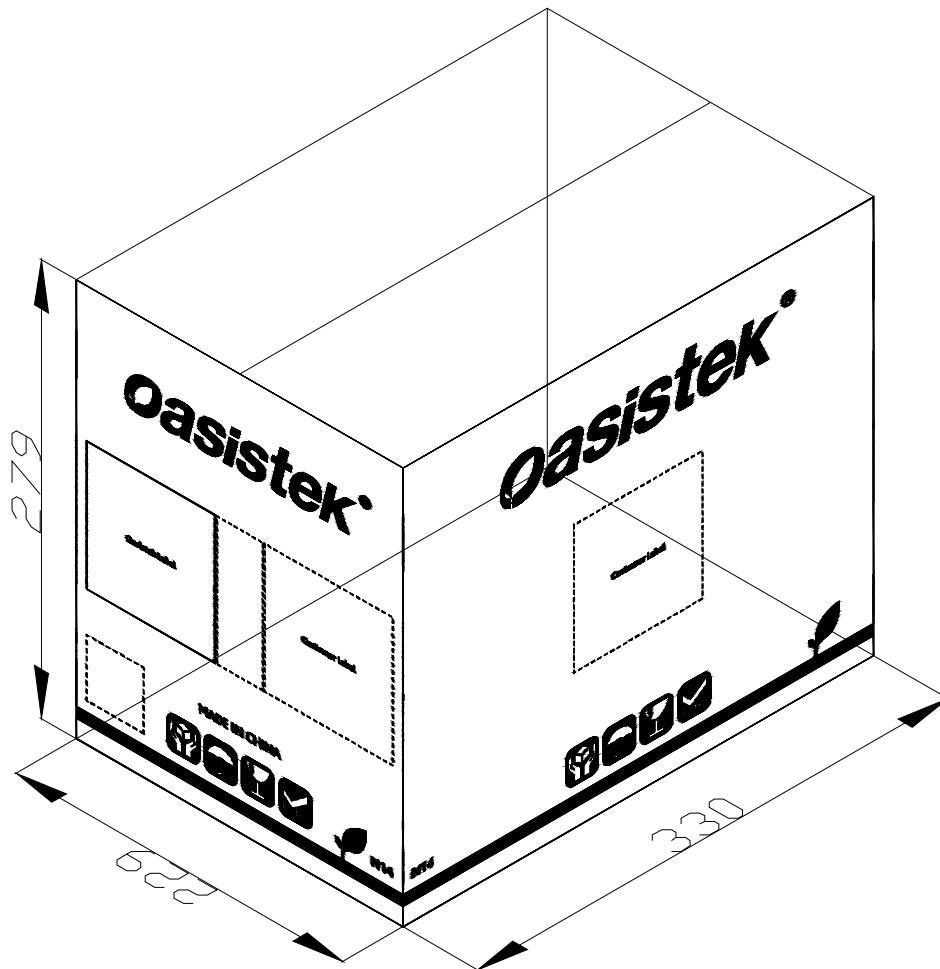
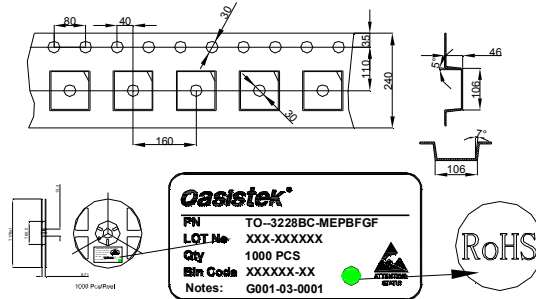

## Soldering Profile

	Reflow Soldering		Hand Soldering	
	Lead Soldering	Lead-free Soldering		
Pre-heat	120~150°C	180~200°C	Temperature Soldering time	350°C Max 3 sec. Max (one time only)
Per-heat time	120 sec. Max	120 sec. Max		
Peak Temperature	240°C Max	260°C Max		
Soldering time	10 sec. Max	10 sec. Max		
Condition				

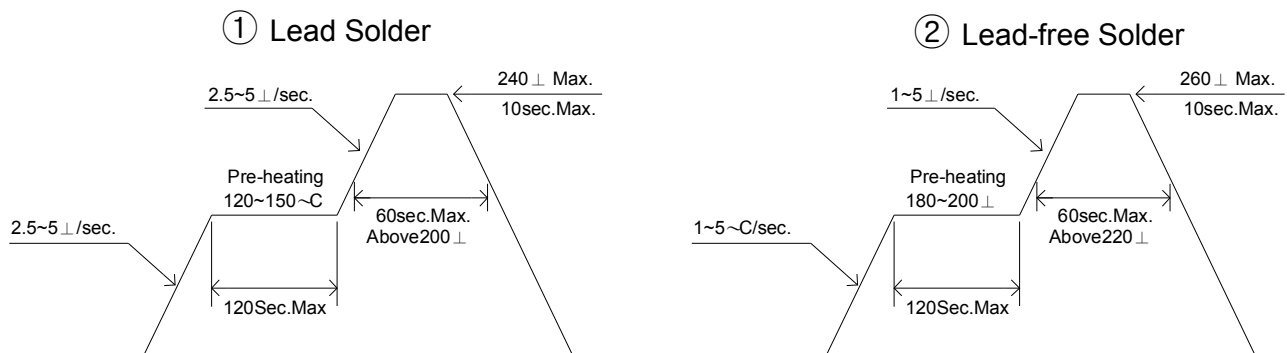

## Cautions

The LED's are devices which are materialized by combining blue LED's and special phosphors. Consequently the color of the LED's is changed a little by an operating current. Care should be taken after due consideration when using LED's.

### (1) Moisture Proof Package:

When moisture is absorbed into the SMT package it may vaporize and expand during soldering. There is a possibility that this can cause exfoliation of the contacts and damage to the optical characteristics of the LED's. For this reason, the moisture proof package is used to keep moisture to a minimum in the package.

### (2) Storage Conditions

#### Before opening the package:

The LED's should be kept at 30°C or less and 60%RH or less. The LED's should be used within a year. When storing the LED's, Moisture proof packaging with absorbent material (silica gel) is recommended.

#### After opening the package:

The LED's should be kept at 30°C or less and 50%RH or less. The LED's should be soldered within 168 hours (7days) after opening the package. If unused LED's remain, they should be stored in moisture proof packages, such as sealed containers with packages of moisture absorbent material (silica gel). It is also recommended to return the LED's to the original moisture proof bag and to reseal the moisture proof bag again. If the moisture absorbent material (silica gel) has faded away or the LED's have exceeded the storage time, baking treatment should be performed using the following conditions. Baking treatment: more than 48 hours at 65±5°C Oasistek LED electrode and lead free are comprised of a silver plated copper alloy. The silver surface may be affected by environments which contain corrosive gases and so on. Please Avoid conditions which may cause the LED to corrode, tarnish or discolor. This corrosion or discoloration might lower solderability or might affect on optical

characteristics. Please avoid rapid transitions in ambient temperature, especially in high humidity environments where condensation can occur.

**(3) Heat Generation**

Thermal design of the end product is of paramount importance. Please consider the heat generation of the LED when making the system design. The coefficient of temperature increase per input electric power is affected by the thermal resistance of the circuit board and density of LED placement on the board, as well as other components. It is necessary to avoid intense heat generation and operate within the maximum ratings given in this specification. The operating current should be decided after considering the ambient maximum temperature of LED's.

**(4) Cleaning**

It is recommended that isopropyl alcohol be used as a solvent for cleaning the LED's. when using other solvents, it should be confirmed beforehand whether the solvents will dissolve the package and the resin or not. Freon solvents should not be used to clean the LED's because of worldwide regulations. Do not clean the LED's by the ultrasonic. When it is absolutely necessary, the influence of ultrasonic cleaning on the LED's depends on factors such as ultrasonic power and the assembled condition. Before cleaning, a pre-test should be done to confirm whether any damage to the LED's will occur °C

**(5) Static Electricity**

Static electricity or surge voltage damages the LED's. It is recommended that a wrist band or an anti-electrostatic glove be used when handling the LED's. All devices, equipment and machinery must be properly grounded. It is recommended that measures be taken against surge voltage to the equipment that mounts the LED's. When inspecting the final products in which LED's were assembled, it is recommended to check. Whether the assembled LED's are damaged by static electricity or not, it is easy to find static-damaged LED's by a light -on test or a VF test at a lower current (below 1mA is recommended). Damaged LED's will show some unusual characteristics such as the leak current remarkably increases, the forward voltage becomes lower, or the LED's do not light at the low current. Criteria ( $V_f > 2.0V$  at  $I_f = 0.5mA$ )

**(6) Others**

Care must be taken to ensure that the reverse voltage will not exceed the absolute maximum rating when using the LED's with matrix drive. The LED light output is strong enough to injure human eyes. Precautions must be taken to prevent looking directly at the LED's with unaided eyes for more than a few seconds. Flashing lights have been known to cause discomfort in people, you can prevent this by taking precautions during use. Also, people should be cautions when using equipment that has had LED's incorporated into it. The LED's described in this brochure are intended to be used for ordinary electronic equipment (such as office equipment, communications equipment, measurement instruments and household appliances) Consult Oasistek's sales staff in advance for information on the applications in which exceptional quality and reliability are required, particularly when the failure or malfunction of the LED's may directly jeopardize life or health (such as for airplanes, aerospace, submersible repeaters, nuclear reactor control systems, automobile, traffic control equipment, life support systems and safety devices). User shall not reverse engineer by disassembling or analysis of the LED's without having prior written consent from Oasistek when defective LED's are found, the User shall inform Oasistek directly before disassembling or analysis. The formal specifications must be exchanged and signed by both parties before large volume purchase begins. The appearance and specifications of the product may be modified for improvement without notice.