



MIC2860-P

High Efficiency 2 Channel WLED Driver with PWM Control

General Description

The MIC2860-2P is a high efficiency white LED (WLED) driver designed to drive two WLEDs and greatly extend battery life for portable display backlighting, and keypad backlighting in low cost mobile devices. The MIC2860-2P architecture provides the highest possible efficiency by eliminating switching losses present in traditional charge pumps or inductive boost circuits. It features a typical dropout of 52mV at 30.2mA per channel. This allows the WLEDs to be driven directly from the battery eliminating switching noise and losses present with the use of boost circuitry.

The two channels have typical matching of $\leq \pm 0.5\%$, which ensures uniform display illumination under all conditions. The WLEDs brightness is externally preset by a resistor and dimmed using PWM interface operating down to less than 1% duty cycle.

The MIC2860-2P is available in Thin SOT-23 and SC-70 six pin packages with a junction temperature range of -40°C to $+125^{\circ}\text{C}$.

Datasheets and support documentation can be found on Micrel's web site at: www.micrel.com.

Features

- High efficiency (no switching losses)
- PWM frequency as low as 250Hz
- Input voltage range: 3.0V to 5.5V
- Linear driver dropout of 52mV at 30.2mA
- Matching better than $\pm 0.5\%$ (typical)
- Current accuracy better than 1.0% (typical)
- Available in Thin SOT-23 and SC-70 packages

Applications

- Mobile handsets
- Digital cameras
- Portable media/MP3 players
- Portable navigation devices (GPS)
- Portable applications

Typical Application

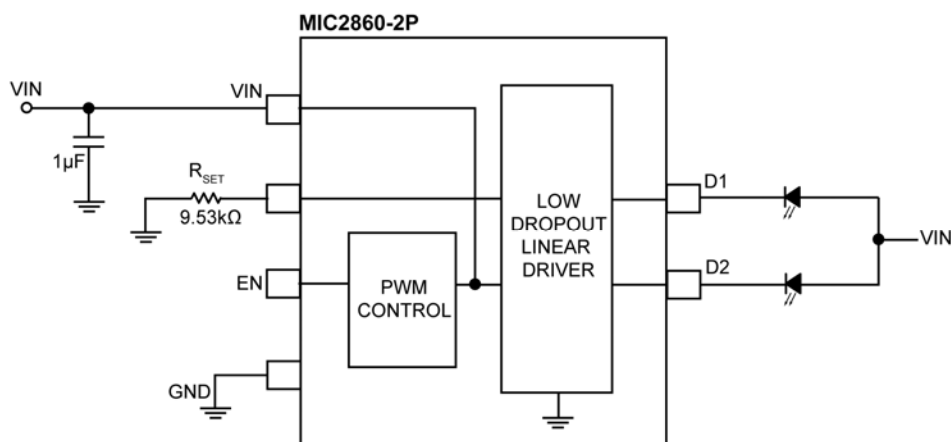

LCD Display Backlight with 2 WLEDs

MLF and *MicroLeadFrame* are registered trademark Amkor Technology Inc.

Micrel Inc. • 2180 Fortune Drive • San Jose, CA 95131 • USA • tel +1 (408) 944-0800 • fax + 1 (408) 474-1000 • <http://www.micrel.com>

Ordering Information

Part Number	Mark Code ⁽¹⁾	Junction Temperature Range	Package ⁽²⁾
MIC2860-2PYC6	<u>62</u> P	-40°C to +125°C	6-Pin SC-70
MIC2860-2PYD6	<u>602</u> P	-40°C to +125°C	6-Pin Thin SOT-23

Notes:

- Under bar symbol () may not be to scale.
- Package is GREEN RoHS compliant. Lead finish is NiPdAu. Mold compound is halogen free.

Pin Configuration

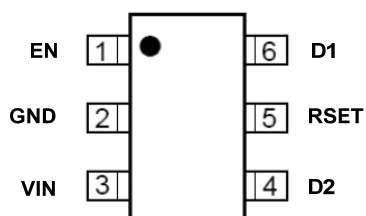

6-Pin SC-70 (C6)
(Top View)

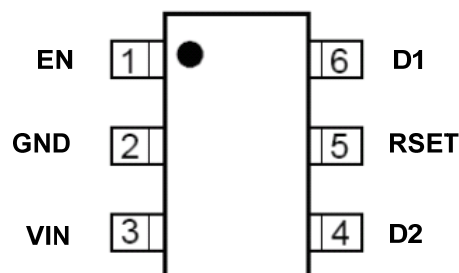

6-Pin Thin SOT-23 (D6)
(Top View)

Pin Description

Pin Number MIC2860-2P	Pin Name	Pin Function
1	EN	PWM Control Pin. This pin is used as a PWM input for dimming of WLEDs. Do not leave floating.
2	GND	Ground.
3	VIN	Voltage Input. Connect at least 1 μ F ceramic capacitor between VIN and GND.
4	D2	LED2 driver. Connect LED anode to VIN and cathode to this pin. Do not leave floating.
5	RSET	An internal 1.27V reference sets the nominal maximum WLED current. Example, apply a 9.53k Ω resistor between RSET and GND to set LED current to 30.2mA at 100% duty cycle.
6	D1	LED1 driver. Connect LED anode to VIN and cathode to this pin. Do not leave floating.

Absolute Maximum Ratings⁽¹⁾

Main Input Voltage (V_{IN})	-0.3V to +6V
Enable Input Voltage (V_{EN})	-0.3V to V_{IN}
LED Driver Voltage ($V_{D1, D2}$)	-0.3V to V_{IN}
Power Dissipation	Internally Limited
Lead Temperature (soldering, 10sec.)	260°C
Storage Temperature (T_s)	-65°C to +150°C
ESD Rating	2KV

Operating Ratings⁽²⁾

Supply Voltage (V_{IN})	+3.0V to +5.5V
Enable Input Voltage (V_{EN})	0V to V_{IN}
LED Driver Voltage ($V_{D1, D2}$)	0V to V_{IN}
Junction Temperature (T_J)	-40°C to +125°C
Junction Thermal Resistance	
SC-70 (θ_{JA})	256 °C /W
SOT-23 (θ_{JA})	177 °C /W

Electrical Characteristics**WLED Linear Drivers**

$V_{IN} = V_{EN} = 3.6V$, $C_{IN} = 1\mu F$, $R_{SET} = 9.53k\Omega$; $V_{D1, D2} = 0.6V$; $T_J = 25^\circ C$, **bold** values indicate $-40^\circ C \leq T_J \leq 85^\circ C$; unless noted.

Parameter	Conditions	Min.	Typ.	Max.	Units
Current Accuracy ⁽³⁾		27.18	30.2	33.22	mA
Matching ⁽⁴⁾			± 0.5	± 3	%
Drop-Out ($V_{D1, D2}$)	Where $I_{LED} = 90\%$ of LED current seen at $V_{DROPNOM} = 0.6V$, 100% brightness level		52	125	mV
Ground/Supply Bias Current	$I_{OUT} = 30.2mA$		0.7	1.5	mA
Shutdown Current (current source leakage)	$V_{EN} = 0V$		0.01	1	μA
PWM Dimming					
Enable Input Voltage (V_{EN})	Logic Low			0.4	V
	Logic High	1.4			V
Enable Input Current	$V_{EN} \geq 1.4$		0.01	1	μA
Current-Source Delay (50% levels)	Shutdown to On		32	80	μs
	Standby to On		1.5	4	
	On to Standby		0.3		
Current-Source Transient Time (10%–90%)	T_{RISE}		0.7		μs
	T_{FALL}		0.2		
On-to-Shutdown Time	$V_{EN} = 0V$	4	5.8	10	ms

Notes:

- Exceeding the absolute maximum rating may damage the device.
- The device is not guaranteed to function outside its operating rating.
- As determined by average current of all channels in use and all channels loaded.
- The current through each LED meets the stated limits from the average current of all LEDs.

Typical Characteristics

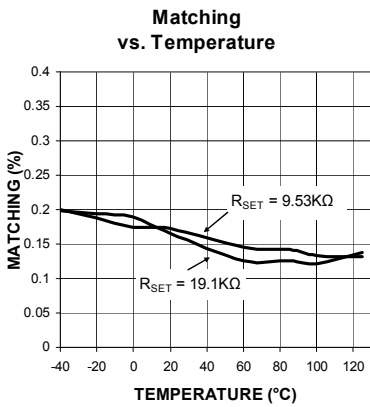
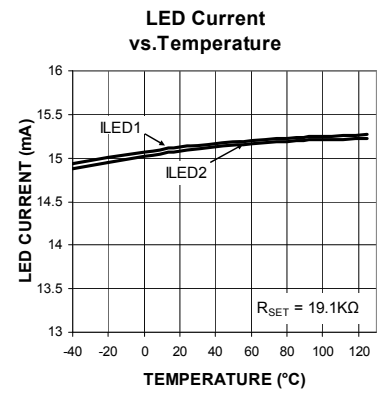
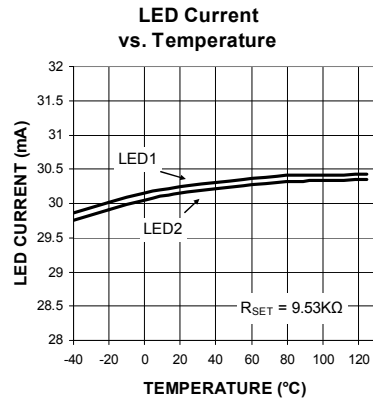
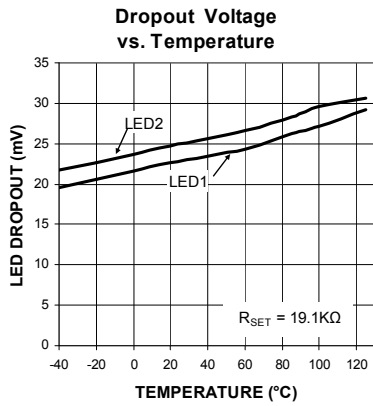
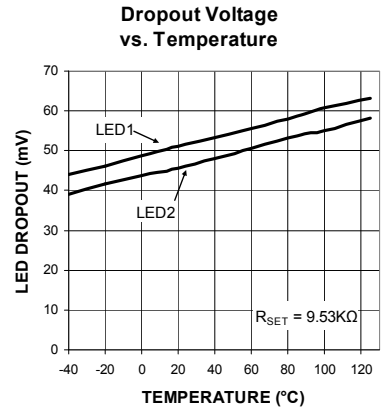
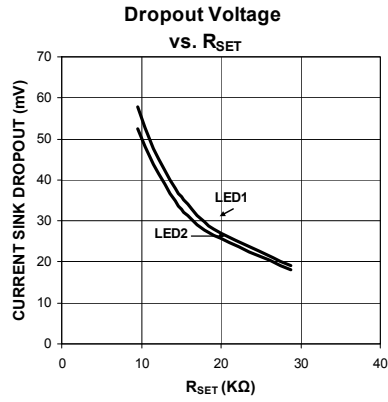
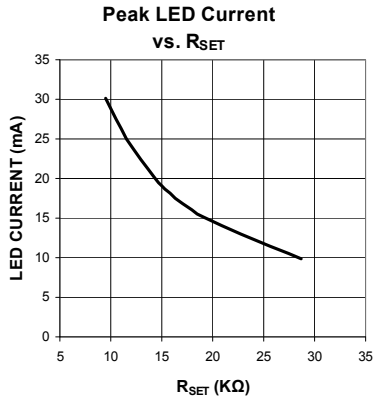

Functional Characteristics

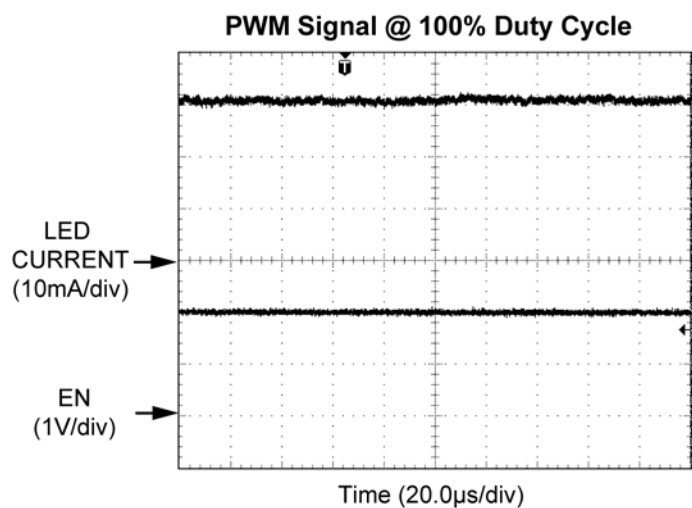
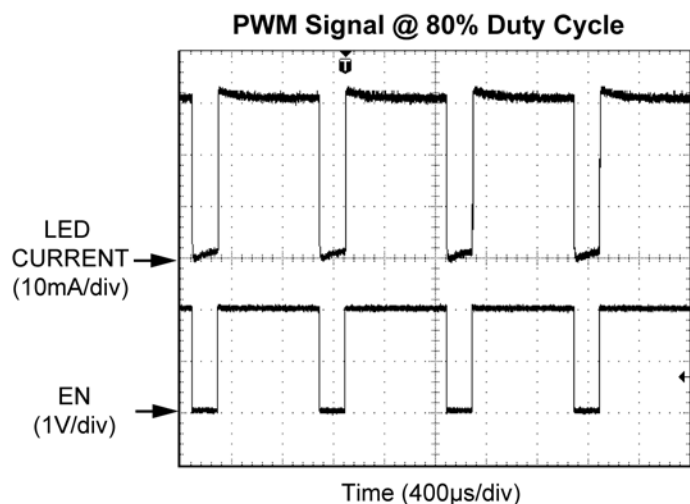
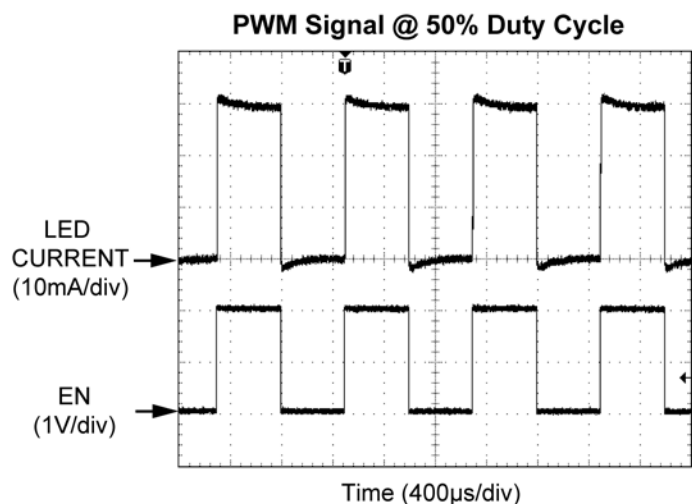
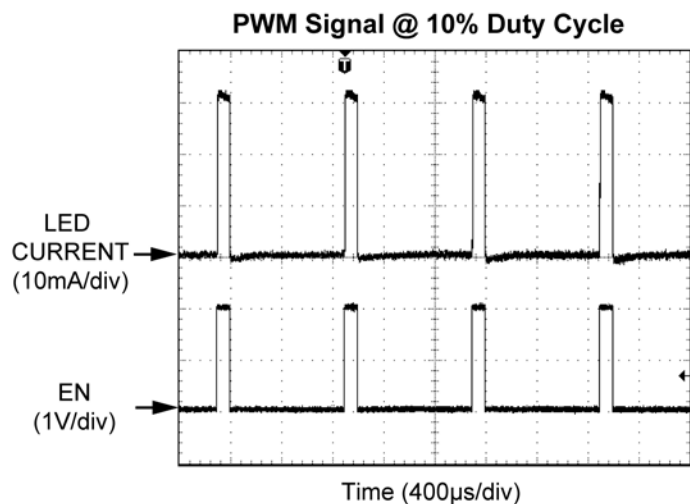
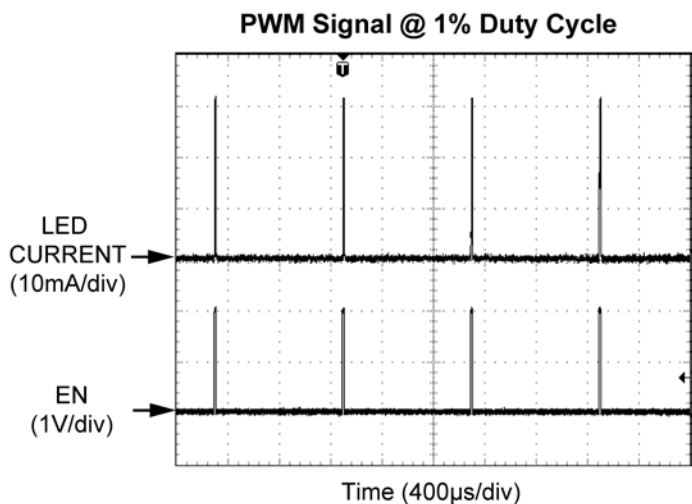

Functional Characteristics (Continued)

LED Startup into 10% Duty Cycle

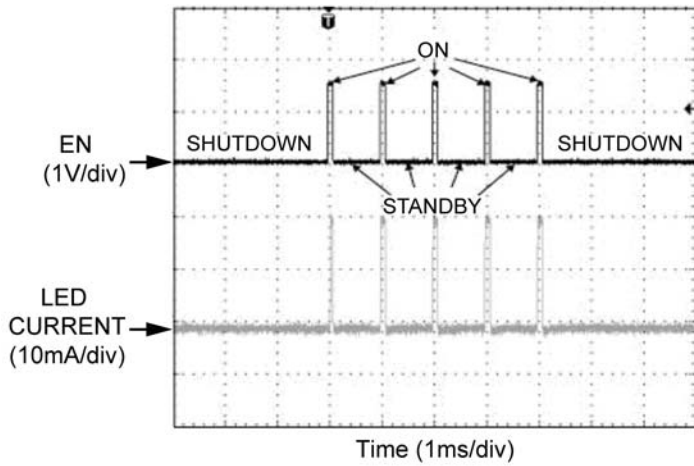

Shutdown to ON

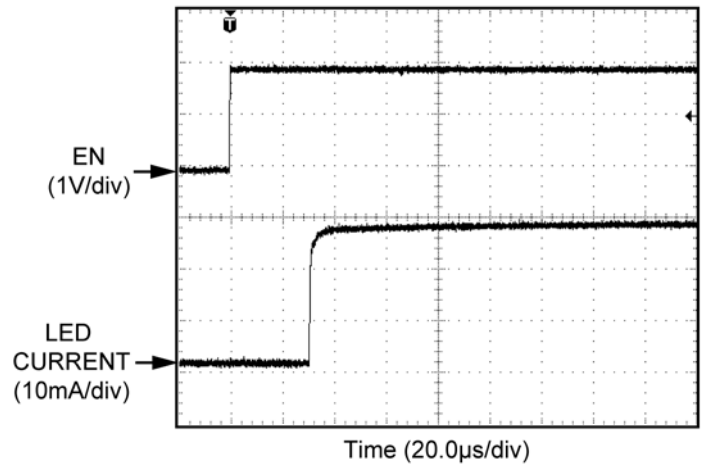

Standby to ON

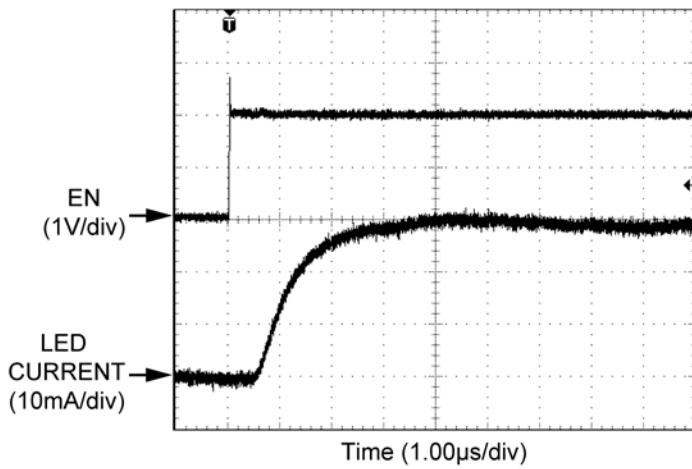

ON to Standby

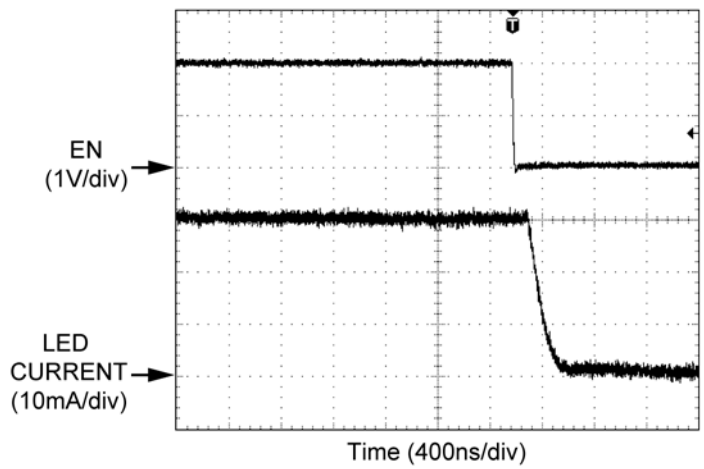

ON to Shutdown

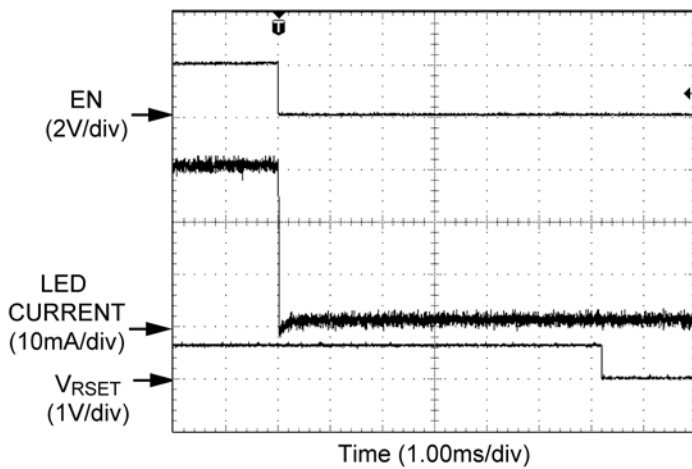

Functional Diagram

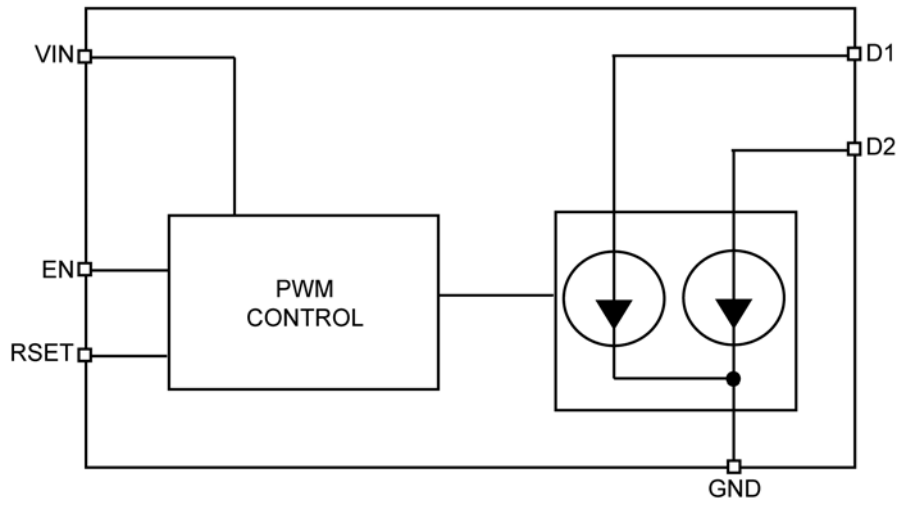

Figure 1. MIC2860-2P Functional Block Diagram

Functional Description

The MIC2860-2P is a two channel WLED driver. The WLED driver is designed to maintain proper current regulation with LED current accuracy of 1% with a typical matching between the 2 channels of $\pm 0.5\%$. The WLEDs are driven independently from the input supply and will maintain regulation with a dropout of 52mV at 30.2mA. The low dropout of the linear drivers allows the WLEDs to be driven directly from the battery voltage and eliminates the need for large and inefficient charge pumps. The peak WLED current for each channel is set via an external resistor. If dimming is desired the MIC2860-2P can dim via a PWM signal.

Block Diagram

As shown in Figure 1, the MIC2860-2P consists of two current sinks with the peak current determined by R_{SET} . The linear drivers have a designated control block for enabling and dimming of the WLEDs. The MIC2860-2P is controlled by the PWM control block that receives PWM signals for dimming.

VIN

The input supply (V_{IN}) provides power to the linear drivers and the control circuitry. The V_{IN} operating range is 3V to 5.5V. Due to wire inductance a minimum bypass capacitor of 1 μ F should be placed close to input (VIN) pin and the ground (GND) pin.

EN

The EN pin enables the linear drivers. It can also be used for dimming with a PWM signal. See the PWM Dimming Interface in the Application Information section for details. Do not leave floating.

RSET

The R_{SET} pin is used by connecting a R_{SET} resistor to ground to set the peak current of the linear drivers. The maximum LED current (EN = 100% Duty Cycle) set by the R_{SET} resistor is shown in the table below:

R_{SET} (k Ω)	I_{LED} (mA)
9.53	30.2
11.5	25.0
14.3	20.1
15.8	18.2
19.1	15.1
28.7	10.0

Table 1. Maximum LED Current vs. R_{SET} Resistor Values

A plot of I_{LED} versus R_{SET} is shown in Figure 2.

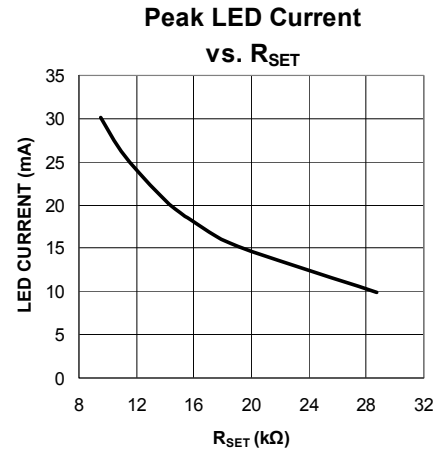

Figure 2. Peak LED Current vs. R_{SET}

D1, D2

The D1 and D2 pins are the linear driver inputs for WLED 1 and 2, respectively. Connect the anodes of the WLEDs to V_{IN} and each cathode of the WLEDs to D1 and D2. When operating with a single WLED, D1 and D2 should be connected to the WLED cathode to parallel the outputs for improved dropout performance. Paralleling these pins can also be done to drive a higher current through a single WLED. Do not leave these pins floating.

GND

The ground pin is the ground path for the linear drivers. The current loop for the ground should be as small as possible. The ground of the input capacitor should be routed with low impedance traces to the GND pin and made as short as possible.

Application Information

PWM Dimming Interface

The MIC2860-2P can receive PWM signals from the EN pin for WLED dimming. Dimming is generated by pulsing the WLEDs on and off in synchronization with the PWM signal. The MIC2860-2P incorporates an internal shutdown delay to ensure that the internal control circuitry remains active during PWM dimming for optimum performance.

The lower PWM frequency range is recommended at 250Hz due to the minimum standby to shutdown time of 4ms. As the period of 250Hz is 4ms, a 1% duty cycle would have an on time of 40us and an off time of 3.96ms. To support operation down to 1% duty cycle, the maximum off time must not exceed 4ms or the drivers may go into the low Iq shutdown state.

With PWM frequencies higher than 500Hz the T_{RISE} (0.7us) and T_{Fall} (0.2us) times will have a greater effect on the accuracy of the outputs. An upper frequency of 500Hz is recommended to maintain output accuracy with duty cycles down to 1%. For systems that do not require a duty cycle below 1%, the frequency of the PWM signal may be increased. For example, with a minimum duty cycle of 10% (3.02mA with $R_{SET} = 9.53k\Omega$) the PWM frequency can be increased to 10kHz and still maintain accuracy.

Input Capacitor

The MIC2860-2P is a high performance, high bandwidth device. Stability can be maintained using a ceramic input capacitor of 1μF. Low-ESR ceramic capacitors provide optimal performance with a minimum amount of space. Additional high frequency capacitors, such as small valued NPO dielectric type capacitors, help filter out high-frequency noise and are good practice in any noise-sensitive circuit. X5R or X7R dielectrics are recommended for the input capacitor. Y5V dielectrics lose most of their capacitance over temperature and are therefore, not recommended.

MIC2860-2P Typical Application Circuit

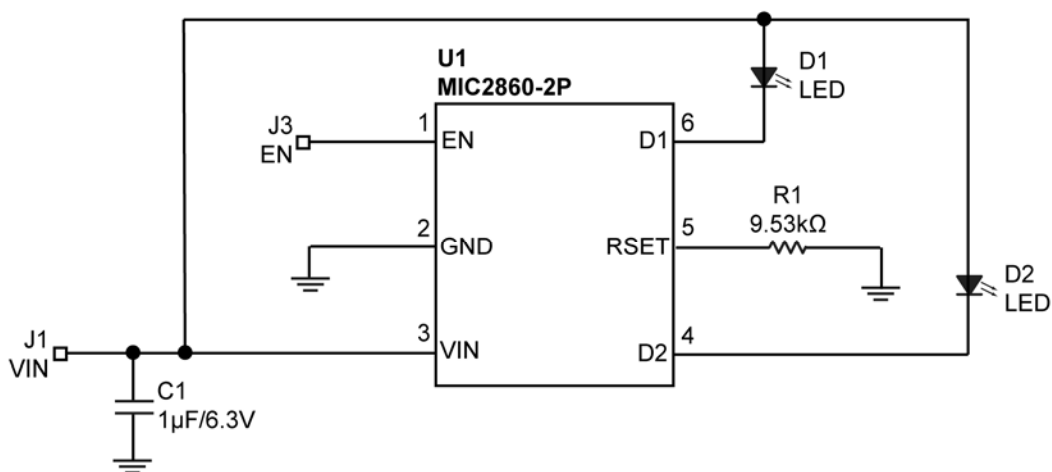

Bill of Materials

Item	Part Number	Manufacturer	Description	Qty.
C1	C1608X5R0J105K	TDK ⁽¹⁾	1µF Ceramic Capacitor, 6.3V, X5R, Size 0603	1
R1	CRCW06032052FT1	Vishay ⁽²⁾	9.53kΩ, 1%, Size 0603	1
U1	MIC2860-2PYC6 MIC2860-2PYD6	Micrel, Inc. ⁽³⁾	2-Channel PWM Linear WLED Driver, SC-70 2-Channel PWM Linear WLED Driver, SOT-23	1

Notes:

1. TDK: www.tdk.com.
2. Vishay: www.vishay.com.
3. Micrel, Inc.: www.micrel.com.

Package Information

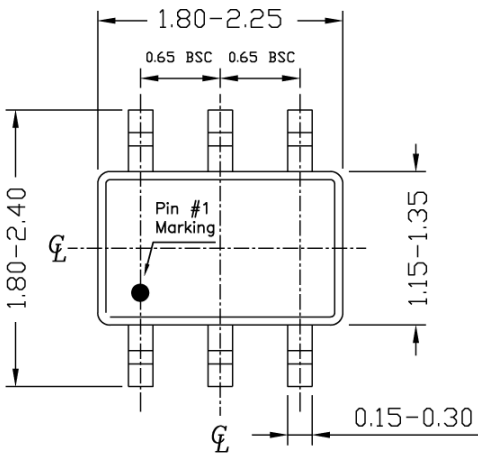

TOP VIEW

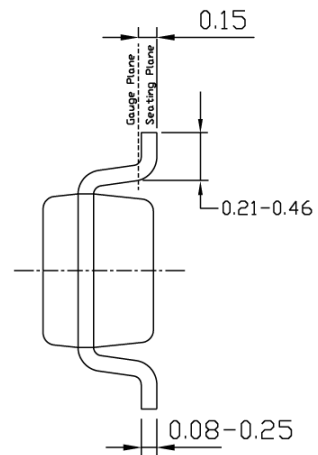

END VIEW

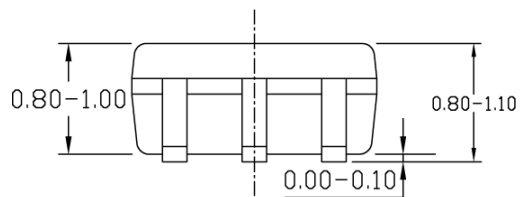

SIDE VIEW

NOTE:

1. ALL DIMENSIONS ARE IN MILLIMETERS.
2. DIMENSIONS ARE INCLUSIVE OF PLATING.
3. DIMENSIONS ARE EXCLUSIVE OF MOLD FLASH & METAL BURR.

6-Pin SC-70 (C6)

Package Information (Continued)

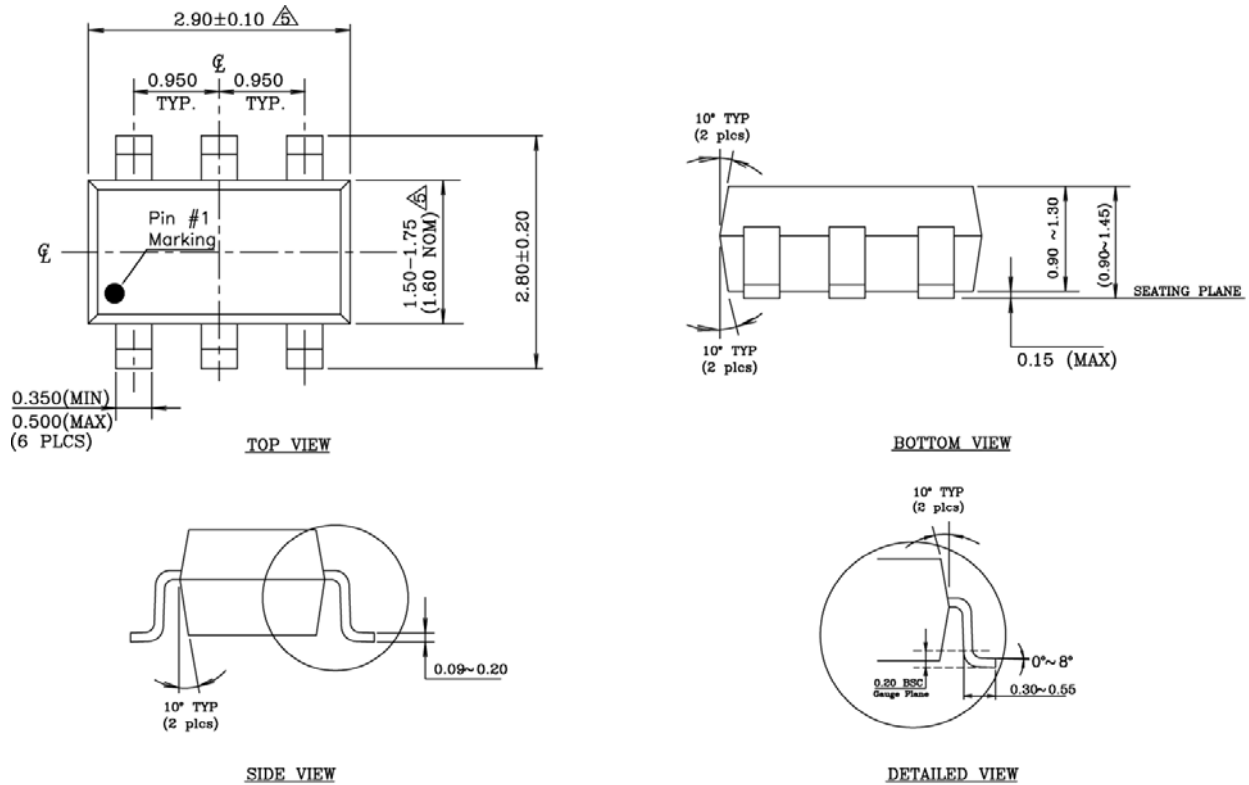

NOTE:

1. Dimensions and tolerances are as per ANSI Y14.5M, 1982.
 2. Package surface to be mirror finish.
 3. Die is facing up for mold. Die is facing down for trim/form, i.e. reverse trim/form.
 4. The footlength measuring is based on the gauge plane method.
- Δ Dimension are exclusive of mold flash & gate burr.

6-Pin Thin SOT-23 (D6)

MICREL, INC. 2180 FORTUNE DRIVE SAN JOSE, CA 95131 USA
 TEL +1 (408) 944-0800 FAX +1 (408) 474-1000 WEB <http://www.micrel.com>

Micrel makes no representations or warranties with respect to the accuracy or completeness of the information furnished in this data sheet. This information is not intended as a warranty and Micrel does not assume responsibility for its use. Micrel reserves the right to change circuitry, specifications and descriptions at any time without notice. No license, whether express, implied, arising by estoppel or otherwise, to any intellectual property rights is granted by this document. Except as provided in Micrel's terms and conditions of sale for such products, Micrel assumes no liability whatsoever, and Micrel disclaims any express or implied warranty relating to the sale and/or use of Micrel products including liability or warranties relating to fitness for a particular purpose, merchantability, or infringement of any patent, copyright or other intellectual property right

Micrel Products are not designed or authorized for use as components in life support appliances, devices or systems where malfunction of a product can reasonably be expected to result in personal injury. Life support devices or systems are devices or systems that (a) are intended for surgical implant into the body or (b) support or sustain life, and whose failure to perform can be reasonably expected to result in a significant injury to the user. A Purchaser's use or sale of Micrel Products for use in life support appliances, devices or systems is a Purchaser's own risk and Purchaser agrees to fully indemnify Micrel for any damages resulting from such use or sale.

© 2010 Micrel, Incorporated.

Mouser Electronics

Authorized Distributor

Click to View Pricing, Inventory, Delivery & Lifecycle Information:

[Microchip:](#)

[MIC2860-2PYD6 TR](#) [MIC2860-2PYD6-TR](#) [MIC2860-2PYC6-TR](#)