

RF Meter click

2. Soldering the headers

Before using your click board™, make sure to solder 1x8 male headers to both left and right side of the board. Two 1x8 male headers are included with the board in the package.

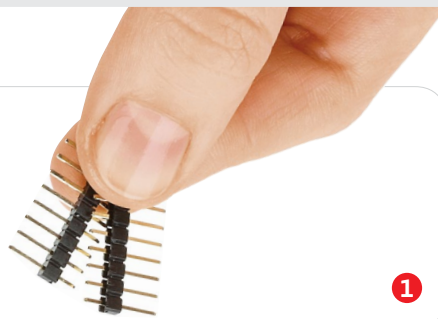

2

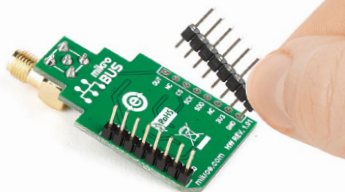

Turn the board upside down so that the bottom side is facing you upwards. Place shorter pins of the header into the appropriate soldering pads.

3

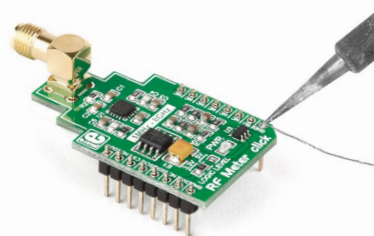

Turn the board upward again. Make sure to align the headers so that they are perpendicular to the board, then solder the pins carefully.

1. Introduction

RF Meter click is a radio frequency power measurement device covering a frequency span from 1 MHz to 8 GHz over a 60 dB range [approximately]. An external antenna acquires the signal, which is then processed by the **AD8318** logarithmic detector. The resulting voltage is fed into an **MCP3201** ADC. For communicating with the target board MCU, the mikroBUS™ SPI interface is used [CS, SCK, MISO pins], with additional TEMP OUT pin.

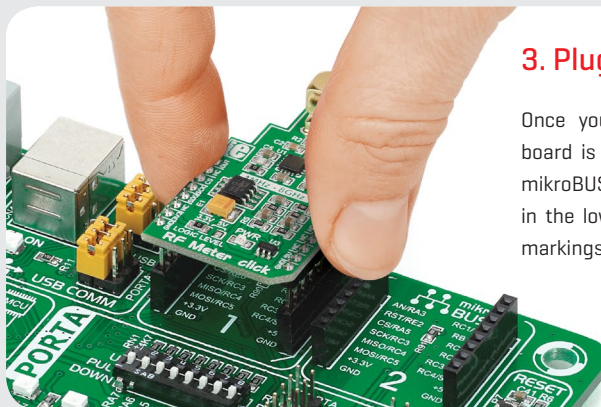

3. Plugging the board in

Once you have soldered the headers your board is ready to be placed into the desired mikroBUS™ socket. Make sure to align the cut in the lower-right part of the board with the markings on the silkscreen at the mikroBUS™ socket. If all the pins are aligned correctly, push the board all the way into the socket.

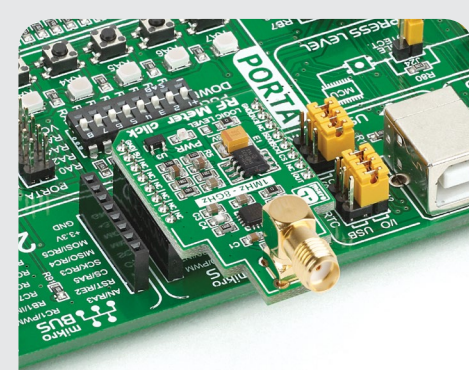

4. Essential features

Radio frequency meters are usually used for testing equipment that includes RF transmitters or relays. It enables monitoring and measuring frequency levels to ensure proper functioning and leak detection. The AD8318 has a 10 nano second response time and a high level of logarithmic intercept stability at various temperature conditions. The chip integrates a temperature sensor whose output is available through the TEMP OUT pin, which can be used for additional system monitoring.

click
BOARDS™
www.mikroe.com



RF Meter click Manual v1.01



010000094402

5. Schematic

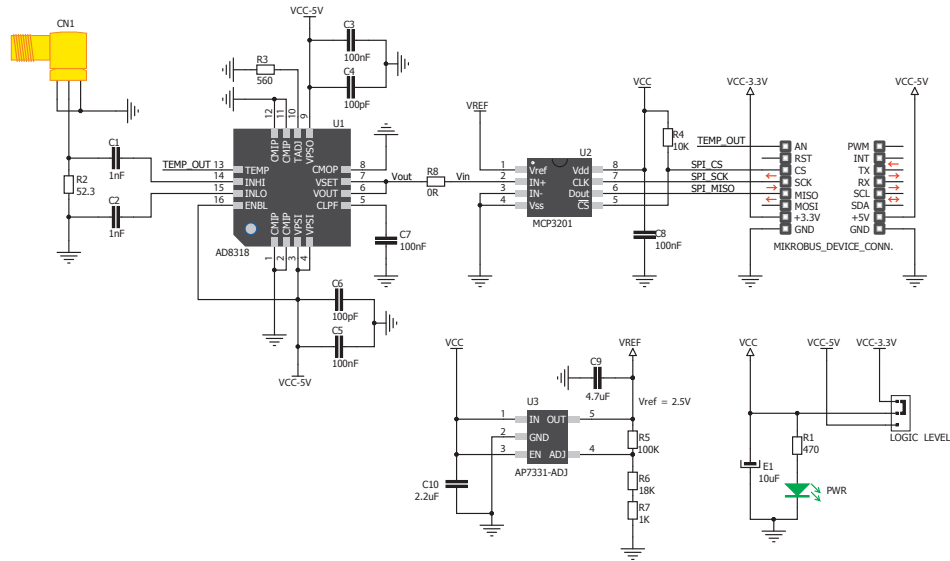

6. Dimensions

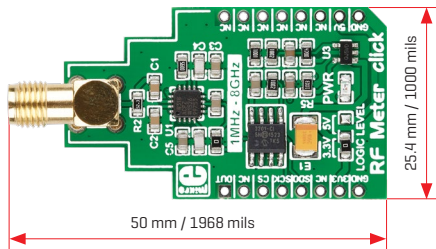

	mm	mils
LENGTH	50	1968
WIDTH	25.4	1000
HEIGHT*	3.9	154

* without headers

7. SMD jumper



RF Meter click has an SMD jumper [zero ohm resistor] for setting the logic level either at 3.3V or 5V.

8. Code examples

Once you have done all the necessary preparations, it's time to get your click board™ up and running. We have provided examples for mikroC™, mikroBasic™ and mikroPascal™ compilers on our **Libstock** website. Just download them and you are ready to start.



9. Support

MikroElektronika offers **free tech support** [www.mikroe.com/support] until the end of the product's lifetime, so if something goes wrong, we're ready and willing to help!



10. Disclaimer

MikroElektronika assumes no responsibility or liability for any errors or inaccuracies that may appear in the present document. Specification and information contained in the present schematic are subject to change at any time without notice.

Copyright © 2016 MikroElektronika.
All rights reserved.

Mouser Electronics

Authorized Distributor

Click to View Pricing, Inventory, Delivery & Lifecycle Information:

[Mikroe:](#)

[MIKROE-2034](#)