

## Your configured drive

Part number\*: B7744E73E907 Revision 1

**maxon motor**

**driven by precision**

Motor - DC-max22S GB SL 12V  
Planetary gearhead - GPX22 C 103:1

maxon motor worldwide  
[http://www.maxonmotor.com/maxon/view/content/contact\\_page](http://www.maxonmotor.com/maxon/view/content/contact_page)

E-Mail: [e-shop@maxonmotor.com](mailto:e-shop@maxonmotor.com)  
Internet: [www.maxonmotor.com](http://www.maxonmotor.com)

After an order is placed at the e-shop, the product is manufactured in Switzerland and delivered after 11 working days.  
General Terms and Conditions: [http://www.maxonmotor.com/maxon/view/content/terms\\_and\\_conditions\\_page](http://www.maxonmotor.com/maxon/view/content/terms_and_conditions_page)

### Interactive 3D model

Click on the icon to activate your 3D model

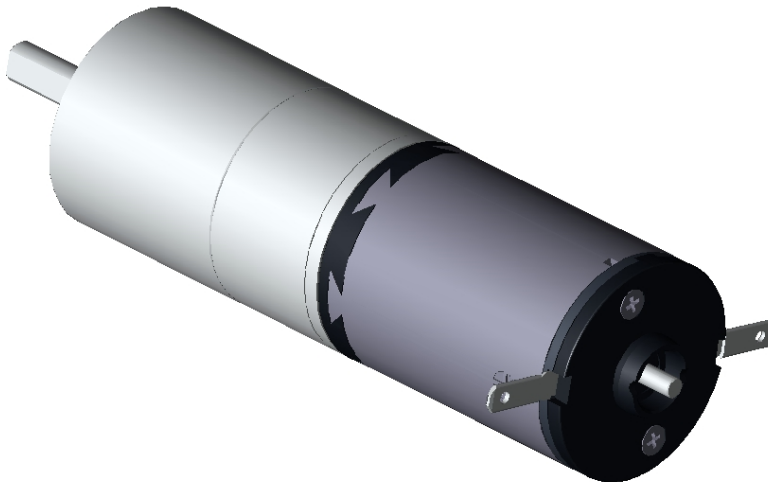

Your configuration can be viewed here:

<http://www.maxonmotor.co.uk/maxon/view/configurator/?ConfigID=B7744E73E907>

\*If the link doesn't work, you can open your configuration with the part number from the catalog.

### Attachments / CAD files

Please double click with left mouse button on a pushpin symbol to open a file. You could also save a file when you click the symbol with the right mouse button.

B7744E73E907.stp (STP AP 214)

**Motor - DC-max22S GB SL 12V  
Planetary gearhead - GPX22 C 103:1**

Drawings are not to scale!

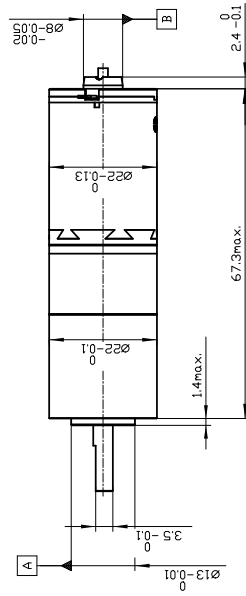
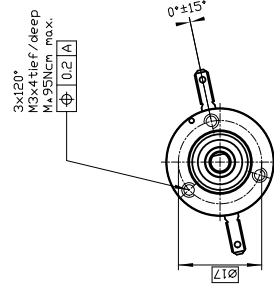
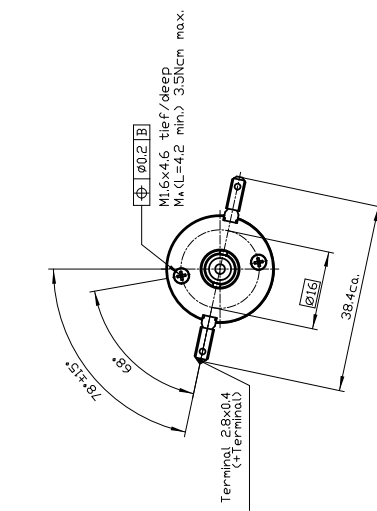

Durchmesser über Schweißstellen 22.2 max.  
Diameter at welds 22E max.

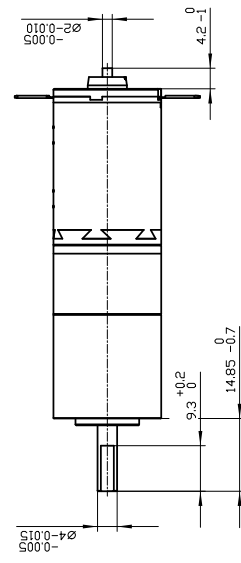

## Summary of your selected configuration

**Motor - DC-max22S GB SL 12V**  
**Planetary gearhead - GPX22 C 103:1**

Total weight of the drive: 122 g

### Motor: DC-max22S GB SL 12V

Commutation	Graphite brushes
Nominal voltage	12 V
Motor bearings	Sintered sleeve bearings

### Gearhead GPX22 C 103:1

Gearhead type	Ceramic version
Reduction	103:1
Number of stages	3

## Operating range

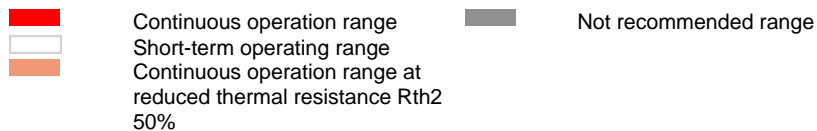
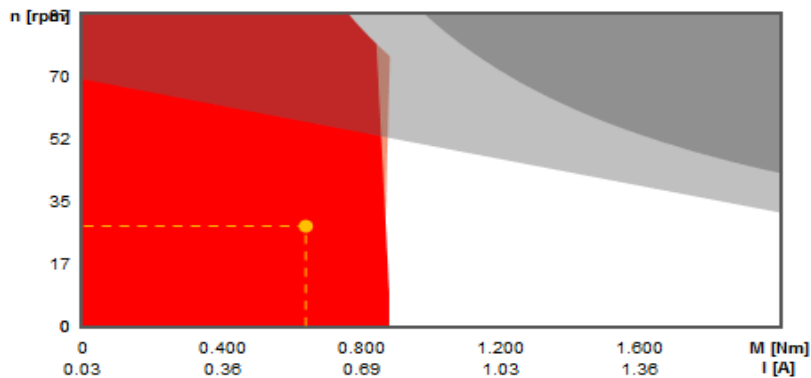

## Motor - DC-max22S GB SL 12V



### Values at nominal voltage

Nominal voltage	12 V
No load speed	7140 rpm
No load current	29.5 mA
Nominal speed	5260 rpm
Nominal torque (max. continuous torque)	12.5 mNm
Nominal current (max. continuous current)	0.818 A
Stall torque	49.4 mNm
Stall current	3.14 A
Max. efficiency	80.3 %

### Characteristics

Max. output power	10.4 W
Terminal resistance	3.83 Ohm
Terminal inductance	0.274 mH
Torque constant	15.8 mNm/A
Speed constant	606 rpm/V
Speed/torque gradient	147 rpm/mNm
Mechanical time constant	8.57 ms
Rotor inertia	5.57 gcm <sup>2</sup>

### Thermal data

Thermal resistance housing-ambient	20 K/W
Thermal resistance winding-housing	6 K/W
Thermal time constant of the winding	17.2 s
Thermal time constant of the motor	538 s
Ambient temperature	-30..85 °C
Max. winding temperature	125 °C

**Mechanical data**

Max. permissible speed	9000 rpm
Min. axial play	0.05 mm
Max. axial play	0.15 mm
Radial backlash	0.012
Max. axial load (dynamic)	1 N
Max. force for press fits (static)	80 N
Max. radial load 5 mm from flange	2.8 N

**Further specifications**

Number of pole pairs	1
Number of commutator segments	9
Weight	47 g
Number of autoclave cycles	0
Typical noise level	55 dBA

Information about motor data: [http://www.maxonmotor.com/medias/CMS\\_Downloads/DIVERSES/12\\_137\\_EN.pdf](http://www.maxonmotor.com/medias/CMS_Downloads/DIVERSES/12_137_EN.pdf)

## Planetary gearhead - GPX22 C 103:1



### Gearhead data

Reduction	103:1
Absolute reduction	371250/3610
Max. transmittable power (continuous)	7 W
Max. transmittable power (intermittent)	9 W
Number of stages	3
Max. continuous torque	1.6 Nm
Max. intermittent torque	2 Nm
Direction of rotation, drive to output	=
Max. efficiency	74 %
Weight	75 g
Average backlash no-load	1.2 degree
Mass inertia	0.43 gcm <sup>2</sup>
Gearhead length	32.2 mm

### Technical data

Output shaft bearing	Ball bearings
Gearhead type	GPX
Max. radial play	0.2 mm
mm from flange	10 mm
Min. axial play	0 mm
Max. axial play	0.2 mm
Max. permissible radial load	120 N
mm from flange	10 mm
Max. axial load (dynamic)	40 N
Max. force for press fits	100 N
Max. continuous input speed	12000 rpm
Max. intermittent input speed	15000 rpm
Min. recommended temperature range	-40..100 °C
Number of autoclave cycles	0

Information about gearhead data: [http://www.maxonmotor.com/medias/CMS\\_Downloads/DIVERSES/12\\_203\\_EN.pdf](http://www.maxonmotor.com/medias/CMS_Downloads/DIVERSES/12_203_EN.pdf)